

THE UK'S BEST SELLING MAGAZINE FOR AMATEUR RADIO ENTHUSIASTS

practical Wireless

AUGUST 1993 £1.90

ANTENNA SPECIAL ISSUE

Build

A Lightweight 9-Element
144MHz Beam

And

A DX Vertical Antenna For
3.5MHz

Reviewed

The Icom IC-2iE 144MHz Hand-Held
Transceiver

The Man Behind The Antenna

Radio Personality Louis Varney G5RV

Plus

Bits & Bytes - The Computer In Your
Shack, Valve & Vintage And Lots More!



FREE

INSIDE THIS BUMPER ISSUE
48 Page Greenweld Electronics
Summer Sale Catalogue

SMC

South Midlands Communications Ltd, S.M. House, School Close, Chandlers Ford Ind. Est., Eastleigh, Hants SO5 3BY

BARGAIN BASEMENT

With the cost of new equipment soaring due to the declining value of the Pound, now is probably the best time ever to consider choosing from one of our vast range of quality ex-demos and used equipment and at prices that are unbeatable value.

To help you secure the rig of your dreams, we can offer a wide choice of payment methods; Cash, Cheque, Visa, Access, Credit Charge or Hire Purchase, subject to status. We will even consider part exchanging your existing equipment.

If the radio of your dreams is not listed below, try giving us a ring, just in case it has arrived today!!

If you prefer to purchase new equipment, then all SMC shops can offer all major brands of equipment, most are available on 'No Interest Finance' and on NEW transceivers from Yaesu, Kenwood and Icom we offer a 2 year warranty.

Why not pop in to your nearest SMC shop or just give us a ring. There has never been a better time than now to get a great deal.



HF EQUIPMENT		£ inc. Vat
AX FT901DE	Yaesu HF Transceiver + FM Board	£439
AX FT757GX	Yaesu HF Transceiver, Mic	£375
AX FT902DM	Sommerkamp HF Transceiver, Boxed	£495
AX IC735	Icom HF Transceiver, Mic	£749
AX F102	Yaesu HF Transceiver, Boxed	£525
AX FT757GX2	Yaesu HF Transceiver, Mic	£750
AX AL84	Ameritron HF Amplifier, Boxed	£399
AX FL2100Z	Yaesu 500W Amplifier	£550
AX FT757GX	Yaesu HF Transceiver	£599
LX TS140	Kenwood Transceiver	£749
LX FT707	Yaesu HF Transceiver	£450
BX FT102	Yaesu HF Transceiver + FM	£589
RX FT102	Yaesu HF Transceiver	£550
RX TS530S	Kenwood HF Transceiver	£550
RX FTONE	Yaesu HF Transceiver	£975
RX FT902	Yaesu HF Transceiver	£550
RX TS930	Kenwood HF Transceiver	£895
RX TS440	Kenwood HF Transceiver	£650
RX FT101ZD	Yaesu HF Transceiver	£475
RX TS530SP	Kenwood HF Transceiver	£525
RX FT7B	Yaesu HF Transceiver	£249.99
RX TS830	Kenwood HF Transceiver	£625
RX FT102	Yaesu HF Transceiver	£425
RX FTONE	Yaesu HF Transceiver	£895
RX FT902	Yaesu HF Transceiver	£495
RX TS120V	Kenwood HF Transceiver	£315
CX FT980	Yaesu HF Transceiver	£895
CX FTONE	Yaesu HF Transceiver	£950
YAESU FT7000	Yaesu Linear Amp 500W	£1499
PX FT107	Yaesu Transceiver + SP107P & FV107	£695
PX FT107M	Yaesu HF Transceiver No PSU	£475
PX FT70G	Yaesu HF Mobile	£399
PX FT747GX	Yaesu HF Transceiver	£875
PX FT757GX	Yaesu HF Transceiver	£625
PX FT757GX2	Yaesu HF Transceiver	£795
PX FT980 (x2)	Yaesu HF Transceiver	£895
PX FT990	Yaesu HF Transceiver	£1895
PX FTONE	Yaesu HF Radio	£939
PX HLK2	Yaesu 2 x 3-500z 1.6-30Mhz	£1275
PX HT180 (x2)	Tokyo 80MTR TX/RX SSB	£289
PX IC725	Icom Transceiver	£624.99
PX IC735	Icom Transceiver	£758.99
PX TS140S (x2)	Kenwood Transceiver	£659
PX TS680S	Kenwood HF Transceiver + 6m	£749
PX TS850SAT	Kenwood HF Transceiver C/W ATU	£1395
PX FT707	Yaesu HF Transceiver 80-10m	£425

VHF EQUIPMENT		£ inc. Vat
AX FT208R	Yaesu 2m Handheld, Mic, Charger	£145
AX TM241E	Kenwood 2m FM Mobile, Boxed	£299
AX FT202	Yaesu 2m 6 ch Handheld	£59
AX IC39T	Icom 70cm Handheld, CTCSS/DTMF	£140
AX 720	ATC Airband Transceiver	£100
AX IC251E	Icom 2m Base fitted Mutek	£450
AX FT690R	Yaesu 6m Portable/Mobile	£229
AX TR9500	Trio 70cm Multimode 10W, Boxed	£325
AX ICW2E	Icom 2m/70cm Handheld	£385
AX TR2300	Trio 2m FM Portable	£119
AX FT411E	Yaesu 2m Handheld, Nicad, Charger	£170
AX 2100M	Mizuho Portable 2m SSB	£115
AX ICW2E	Icom 2m/70cm Handheld, C/W CTCSS	£385
AX C5608D	Standard 2m & 70cm Mobile, Boxed	£500
AX FT470	Yaesu 2m/70cm Handl, Nicad, Charger	£299
AX TR2500	Trio 2m Handheld, Charger, Nicad	£125
AX FT23R	Yaesu 2m Handheld, Charger, Nicad	£169
AX FT290R	Yaesu 2m Multimode, Nicads, Charger	£265
AX Transverter	R&N 28Mhz Input, 50 Mhz out	£149
AX IC211	Icom 2m Base, Desk Mic, Boxed	£369
AX ICW2E	Icom Handheld	£385
AX TR2300	Trio Transceiver	£119
LX SAGRA600	Tokyo 2m Amplifier	£699
LX FT480R	Yaesu 2m Multimode	£295
BX FT290R2	Yaesu 2m Multimode, Nicads, Boxed	£489
BX FT990R2	Yaesu 70cm Multimode, Nicads, Chrgr, Box	£519
RX FT901	Yaesu Transceiver (2m fitted)	£175
RX FT650	Yaesu TXCR 6/10/12m C/W FP22	£1195
RX FT204	Yaesu 2m Handheld TXCR	£145
RX FT727R	Yaesu 2m/70cm Handheld TXCR	£260
RX FT290R	Yaesu 2m Multimode TXCR	£225
RX TS711E	Kenwood 2m Base Station	£725
RX FT290MKII	Yaesu 2m TXCR	£395
RX FT290R	Yaesu 2m Multimode TXCR	£249.99

RX FTV107/2	Yaesu Transverter	£135
RX FT726R	Yaesu 2m/70cm TXCR	£825
RX FT780R	Yaesu 70cm TXCR	£350
RX 4SRE	Icom 70cm TXCR Wide band RX	£330
RX HT106	Tokyo 6m TXCR	£195
RX IC-24ET	Icom 2/70 Handheld TXCR	£350
CX DJ580E	Alinco VHF UHF Handi	£395
CX FT727R	Yaesu B1 Transceiver (FNB4A)	£275
CX FT73R	Yaesu 70cm Handi C/W Nicad	£175
CX TH205E	Kenwood Handheld 2m	£175
CX FT790R2	Yaesu 70cm Multimode	£425
PX FT211RH	Yaesu 2m Mobile FM	£289
PX FT23R (x2)	Yaesu 2m Handheld	£189
PX FT26	Yaesu 2m Handheld, FNB28, NC28C	£259
PX FT690R2	Yaesu Transceiver	£375
PX FT73R	Yaesu 70cm + FNB12	£189
PX FT990R2	Yaesu FM Transceiver	£499
PX IC229H	Icom 2m FM Transceiver	£299
PX IC22U	Icom 2mtr Mobile	£120
PX SAGRA-600	Tokyo 2m Linear 600W Output	£699
PX TX280FM	Kenwood 2mtr	£129
PX IC229	Icom 2m FM Transceiver	£299
PX FT209R	Yaesu 2m FM Handi	£139

RX & SCANNERS		£ inc. Vat
AX MX7000	Regency Wideband Scanner	£229
AX FRG7000	Yaesu Receiver	£250
AX ICR7100	Icom Base Scanner	£1000
AX FRG9600M	Yaesu Scanner PSU, Boxed	£299
AX ICR1/SSB	Icom Scanner + SSB	£329
AX ICF2001D	Sony Shortwave Receiver, Boxed	£169
AX R2000	Kenwood Shortwave Receiver, Boxed	£399
AX FRG7	Yaesu Shortwave Receiver, Boxed	£179
AX ICR7000HF	Icom Base Receiver	£825
AX R532	Signal Airband Receiver, Boxed	£125
AX 800KLT	Bearcat Desktop Scanner	£169
AX R2000	Trio Shortwave Receiver	£369
AX HP200E	Fairmate Handheld Scanner	£199
AX AR2002	AOR Handheld Scanner	£199
AX ICF7600	Sony Shortwave Receiver	£110
AX ICR71E	Icom Shortwave Receiver, Boxed	£639
AX MV15000	Yupiter Handheld Scanner, Boxed	£179
AX FRG7	Yaesu Receiver	£179
LX IC-R100	Icom Scanner	£380
LX AR1500E	Icom Scanner	£259
RX ICF-80	Sony Receiver with Airband	£220
RX AR2001	AOR Wideband Scanner	£194.99
RX AR900	AOR Handheld Scanner	£145
RX AIR7	Sony Airband Receiver	£140
RX ICF2001D	Sony Receiver	£225
RX DRB600	Panasonic HF Receiver	£185
RX R2000	Trio HF Receiver	£495
RX FRG9600M	Yaesu VHF/HF Receiver	£440
RX RS3000	Revco Wideband Scanner	£135
RX SRG86000DX	Sumerkamp Wideband Scanner	£350
RX ICF5V55	Sony Receiver	£225
RX FRG7700	Yaesu HF Receiver	£295
CX FRG9600	Yaesu Scanner	£325
PX AIR7 (x2)	Sony Airband Scanner	£169
PX AR3000 (x2)	AOR Scanner	£598.99
PX FRG9600	Yaesu Scanning RX	£439
PX ICF2001D	Sony Portable Receiver	£245
PX PR080	Sony Scanner	£219
PX PR09200	Realistic Scanner	£109

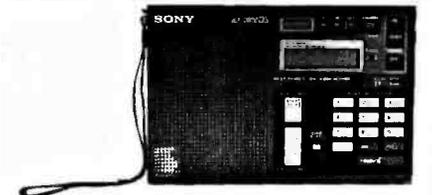

DATA EQUIPMENT		£ inc. Vat
AX APR2010	Pocom Auto Decoder CW/RTTY	£225
LX AMT2	ICS Amtor Terminal	£109
BX PK232MBX	ICS Data Terminal with Mailbox	£269
RX TNC24	Tereleader Teraleader Packet Terminal	£284.35
PX AMT1	ICS Amtor Unit	£99
PX AMT2 (x2)	ICS Data Unit	£90
PX KB4001-KB(x2)	M/M RTTY RX/TX Unit	£169

ACCESSORIES		£ inc. Vat
AX MMT28/44	M/M 28 Mhz Transverter	£80
AX PC1	Datong Converter	£70
AX MML144/100S	M/M 100W Amplifier	£115
AX UC1	Datong HF Converter	£69
AX Starmaster	Dewsbury Memory Keyer	£65
AX 144/100S	M/M 2m Amplifier 100W	£110
AX Wavemeter	S/E HF Wave Meter	£29
AX UC1	Datong HF Converter	£65



AX PS15	Icom PSU	£125
AX CT530	Welz 250W Dummy Load	£45
AX FRA7700	Yaesu Active Antenna	£45
AX SM6	Icom Desk Microphone	£30
AX Supa Tota	Dewsbury Morse Code Teacher	£50
LX 12/25A	BNOS PSU	£185
BX ICSP3	Icom External Loudspeaker	£50
BX FL2025	Yaesu Clip-on Linear 25W	£90
BX FL7025	Yaesu Clip-on Linear 25W	£119
RX KP-100	Kenpro Keyer Unit	£75
RX BC-8	Kenwood Desk Charger	£30
RX C500	Standard 2m/70cm handheld	£150
RX MR750E	Daiwa Rotator	£185
RX 12/6A	BNOS 6A Power Supply	£60
RX VF0240	Kenwood Ext VFO	£75
RX 12/25	BNOS 25A Power Supply	£194.99
RX FV1012	Yaesu Ext VFO	£75
RX FC965DX	Yaesu Converter for Yaesu 9600	£45
RX FV102	Yaesu Ext VFO	£185
RX LP50/10/50	BNOS 6m Linear	£125
RX MMT144/28	M/M 2m/10 Transverter	£70
RX HX240	Tokyo HF Transverter	£195
RX EK150	Katsunomi Electronic Keyer	£54.99
RX MML144/30	M/M 2m Linear	£70
RX FRV8800	BNOS VHF Converter	£70
LX 12/25A	Yaesu PSU	£185
RX 12A	Brae 12A Power Supply	£45
LX 12/25A	BNOS PSU	£185
RX BC72	Icom Base Charger	£75
PX FC757AT	Yaesu Tuner	£275
PX FIF232C	Yaesu Cat Interface	£75
PX FMUTT747 (x2)	Yaesu FM Unit for FT747	£35
PX FP707	Yaesu Power Unit	£111.63
PX FP757HD	Yaesu Power Unit	£169
PX FSS500V (x2)	Yaesu SWR Meter 50-150Mhz	£79
PX FSS50VP (x2)	Yaesu SWR Meter 50-150Mhz	£79
PX FS710V	Yaesu SWR Meter 50-150Mhz	£79
PX HK 802	Himound Morse Key Straight	£74.95
PX HL100B/20	Tokyo 20m Band Amplifier	£149
PX HL100B/10	Tokyo 10m Band Amplifier	£154.99
PX HL166V	Tokyo 6m Linear 160W	£215
PX KP100	Kenpro Squeeze Keyer	£69
PX KR250	Kenpro Rotator Bell	£70.50
PX MD1C8	M/M Desk Mic	£69
PX MMT1268SAT	Yaesu Sat TX Converter	£135
PX MMT28V	M/M 1m Low Noise Pre Amp	£19
PX MM1296 (x2)	M/M 1296Mhz Converter 2 MIF	£99
PX MMT144/100S	M/M 2m Linear Amp	£99
PX MMT432/144R	M/M Transverter C/W Repeater	£99
PX NC15	Yaesu Charger Quick FNB3/4	£59
PX NC42	Yaesu Desktop Charger	£75
PX PS14011	Daiwa Power Supply	£49
PX MMT50/144	M/M 6m Transverter	£268.99
PX PS304	Daiwa Daiwa 24/30A PSU	£105
PX 12/25A	BNOS BNOS 25A PSU	£189
PX FC707	Yaesu Antenna Tuner	£109
PX FTS12	Yaesu CTCSS Unit	£49
PX LPM144-10-100	BNOS 2m 10-100W Amp	£139
PX 50/767 (x2)	Yaesu 6m Module FT767GX	£159
PX LMP50-10-100	BNOS 6m 10-100W Amp	£199



KEY		
PX SMC SOUTHAMPTON	TEL: 0703 251549/255111	
BX SMC BIRMINGHAM	TEL: 021 327 1497/6313	
CX SMC CHESTERFIELD	TEL: 0246 453340	
LX SMC LEEDS	TEL: 0532 350606	
AX ARE LONDON	TEL: 081-997 4476	
RX REG WARD AXMINSTER	TEL: 0297 34918	

20 Review - Icom IC-2iE FM Transceiver



Richard Newton G0RSN tries out one of the smallest 144MHz hand-helds.

22 The Bourbon QRP Transmitter Part 2

Bill Mooney G3VZU continues with the construction and testing of this double sideband, suppressed carrier 3.5MHz band transmitter.

25 The Tiny Tim 3.5MHz SSB Transceiver Part 2

Tim Walford G3PCJ tells you how to link the transmitter into the receiver he showed you last month.

28 Review - The Palomar PK-44 Keyer

Christopher Page G4BUE tries out an interesting electronic keyer from the USA.

30 Radio Personality - Louis Varney G5RV

Rob Mannion G3XFD meets the inventor of the famous 'G5RV' antenna.

32 Wide-Band VLF/LF/MF Amplifiers & Coaxial Antennas

Richard Q. Marris G2BZQ describes a pre-amplifier kit for use between coaxial loops and shows how to extend the cover on m.w. and 1.8MHz bands.

34 Where Can I Buy ... A Directory Of Antenna Suppliers

The PW team show you what's available in the antenna world and from whom.

38 A DX Vertical Antenna for 3.5MHz

Ron Stone GW3YDX describes an effective antenna for 3.5MHz.

40 A Lightweight 9-Element Beam For 144MHz

Tony Martin G4XBY details how he built a 9-element beam antenna.

43 Antenna Workshop

Peter Dodd G3LDO reviews an antenna and two antenna accessories.

45 Book Reviews

PW evaluates a selection of antenna related books.

46 Bits & Bytes - The Computer In Your Shack

Peter Hunter G0GSZ looks Interesting CD-ROMs and software.

FRONT COVER ACKNOWLEDGEMENTS

Our thanks go to Cushcraft Antennas, PO Box 4680, Manchester, NH03108 USA, Tel: 010-603 627 7877 for supplying the antenna activity shot.

48 Valve & Vintage

Ron Ham opens the PW vintage wireless shop once again to look at your letters, fault finding problems and restoring military equipment.

50 HF Bands

Paul Essery GW3KFE brings you the latest news on the h.f. bands.

53 Satellite Scene

Pat Gowen G3IOR relates some news on the progress of AMSAT Phase-III-D and OSCAR-13.

54 VHF Report

David Butler G4ASR reports on the fascinating world above 30MHz.

56 Packet Panorama

Roger Cooke G3LDI with news on a data controller, band plans and channel spacing.

57 Broadcast Round Up

Peter Shore brings you tips on holiday listening on the world's short wave stations.

59 Focal Point

Andy Emmerson appears on screen for his bi-monthly look at the world of amateur TV.

Other Regular Features

- 68 Advert Index
- 60 Arcade, All PW Services under one roof
- 61 Bargain Basement
- 16 Club News
- 9 Competition
- 9 Keylines
- 12 Newsdesk '93
- 33 Radio Diary
- 10 Receiving You

Staff

EDITORIAL & ADVERTISEMENT OFFICES

Practical Wireless
Arrowsmith Court
Station Approach
Broadstone
Dorset BH18 8PW
(0202) 659910
(Out-of-hours service by answering machine)

CREDIT CARD ORDERS

(0202) 659930
(Out-of-hours service by answering machine)
FAX (0202) 659950

Editor
Rob Mannion G3XFD

Art Editors

Steve Hunt
Richard Gale

Technical Projects Sub-Editor

NG ("Tex") Swann G1TEX

Production/News

Donna Vincent

Editorial Assistant

Zoë Shortland
Advertisement Manager
Roger Hall G4TNT
PO Box 948
London SW6 2DS
071-731 6222
Cellphone (0850) 382666
FAX 071-384 1031

Advert Copy and Sales (Broadstone Office)

Lynn Smith (Sales), Ailsa Turbett (Production)
(0202) 659920 FAX (0202) 659950

Copyright © PW PUBLISHING LTD. 1993. Copyright in all drawings, photographs and articles published in *Practical Wireless* is fully protected and reproduction in whole or part is expressly forbidden. All reasonable precautions are taken by *Practical Wireless* to ensure that the advice and data given to our readers are reliable. We cannot however guarantee it and we cannot accept legal responsibility for it. Prices are those current as we go to press.
Published on the second Thursday of each month by PW Publishing Ltd., Arrowsmith Court, Station Approach, Broadstone, Dorset BH18 8PW. Tel: (0202) 659910. Printed in England by Southerprint (Web Offset) Ltd. Distributed by Seymour, Windsor House, 1270 London Road, Norbury, London SW16 4DH. Tel: 081-679 1899, Fax: 081-679 8907, Telex: 8812945. Sole Agents for Australia and New Zealand - Gordon and Gotch (Asia) Ltd.; South Africa - Central News Agency. Subscriptions INLAND £21, EUROPE £23, OVERSEAS (by ASP) £25, payable to PRACTICAL WIRELESS, Subscription Department, PW Publishing Ltd., Arrowsmith Court, Station Approach, Broadstone, Dorset BH18 8PW. Tel: (0202) 659930. PRACTICAL WIRELESS is sold subject to the following conditions, namely that it shall not, without written consent of the publishers first having been given, be lent, re-sold, hired out or otherwise disposed of by way of trade at more than the recommended selling price shown on the cover, and that it shall not be lent, re-sold, hired out or otherwise disposed of in a mutilated condition or in any unauthorised cover by way of Trade, or affixed to or as part of any publication or advertising, literary or pictorial matter whatsoever. *Practical Wireless* is published monthly for \$45 per year by PW Publishing Ltd., Arrowsmith Court, Station Approach, Broadstone, Dorset BH18 8PW, UK Second Class postage paid at Middletown, N.J. Postmaster: Send USA address changes to *Practical Wireless*, c/o Permit to post at Hackensack pending. The USPS (United States Postal Service) number for *Practical Wireless* is: 007075.

COMING
NEXT MONTH

Practical Wireless looks into
the world of test equipment
DON'T MISS IT!

ICOM YAESU KENWOOD ALINCO

RADIO

HAMSTORES LONDON OPEN DAY

11 Watford Way Hendon London NW4 3JL Tel: 081 202 0073 Fax: 081 202 8873

**CALLING ALL RADIO AMATEURS
AND SHORTWAVE LISTENERS!
ICOM (UK) PROUDLY PRESENT...**

**THE OFFICIAL OPENING OF OUR NEW LONDON
HAMSTORE • SPECIAL BARGAINS INCLUDING: IC-737 •
IC-W21ET • FRG100 • TS50 ETC • EQUIPMENT DEMOS •
COFFEE • TEA • BUCKS-FIZZ • HAM SANDWICHES (SORRY)
• CAKE • SPECIAL GUESTS • FREE RAFFLE • & LOTS MORE!**

We would like to say thanks to all of you who have supported us over the last few months. If you haven't visited the London Hamstore yet - why not? We have bargains on new, used and ex-demo equipment. We will gladly take your good, clean, working gear in part-exchange - call us now for the best prices around. As well as ICOM, we also stock KENWOOD, YAESU and all leading brand names.

Do you know who the staff are at Hendon? Well there's Paul G7MNI who has had technical features published in many radio mags + Doug G0LUH/4S7DGG/4S0UK/8Q7AB, who would you prefer to deal with? salesmen or...

Saturday July 24th.

We have receivers, transceivers and every conceivable gadget you could want. If it's cash, credit or part-exchange - we do it. We are probably the world leaders in radio communications and have the best technical back-up and service facilities in the country. Call now for our daily-updated list of second-hand equipment.

qualified staff with a wealth of experience and knowledge, we know, and you know it makes sense. Payment by Access, Visa, Switch and RSGB cards are welcome, finance can also be arranged (subject to status). Interest-free credit is available on selected new ICOM products. If you cannot visit a HAMSTORE in person, take advantage of our MAIL ORDER SERVICE. Items from stock normally dispatched within 24hrs. HAMSTORES stock AEA, AKD, Alinco, AOR, Barenco, Comet, Cushcraft, Davis, Dee Comm, Diamond, Icom, JRC, Kenwood, Lowe, Microset, MFJ, RSGB books, Toyo, Yaesu and Yupiteru equipment. **73 Doug & Paul.**

**How to get here...
Northern Line tube to
Hendon Central or... simply
park your car outside.**



RADIO HAMSTORES

ALSO AT...

HERNE BAY

Unit 8, Herne Bay West Ind. Estate, Sea Street,
Herne Bay, Kent CT6 8LD.

Tel: 0227 741555 Fax: 0227 741742

BIRMINGHAM

International House,
963 Wolverhampton Rd. Oldbury,
West Midlands B69 4RJ

Tel: 021 552 0073 Fax: 021 552 0051

**ALL STORES NOW OPEN: MON TO FRI 09:00-17:00
& 09:00-16:00 SATS.**

N.B. Herne Bay closed for lunch 1300-1400.

THE THREE POINTS OF THE KENWOOD TRIANGLE REPRESENT ADVANCED TECHNOLOGY, QUALITY AND STYLE

FOR THE PRICE,
YOU'D EXPECT
THE WORLD.
YOU'LL GET IT.



The TS-950SDX is at the very pinnacle of the Kenwood HF transceiver range. And when you look at its specification, that's not surprising.

It boasts a number of highly advanced features like built-in digital signal processing, 50 Volt MOSFET finals, AIP

(advanced intercept point), built-in sub-receiver and built-in automatic antenna tuner. To name but some of its world-leading technical tour-de-force.

Just as important, it's made with Kenwood's traditional attention to detail and reliability, to stand up to a lifetime's use.

The TS-950SDX is part of a range of HF transceivers priced from around £1000 to £3500. And although quality is never cheap, it's still a small price to pay to have the world of radio communications at your command.

KENWOOD

WATERS & STANTON ELECTRONICS

ALINCO KENWOOD YAESU ICOM DIAMOND MFJ MICROSET TONNA REVEX

Diamond Power Meters

Very Accurate & Reliable



Specifications:

- SX-200** 1.8 - 200MHz 5W-20W-200W
Connectors SO-239 RMS or PEP
£89.95 + £6 p&p
- SX-400** 140 - 525MHz 5W-20W-200W
Connectors SO-239 RMS or PEP
£104.95 + £6 p&p
- SX-600** 1.8 - 525MHz 5W-20W-200W
Connectors SO-239 RMS or PEP
£164.95 + £6 p&p

QRP CORNER



- MFJ 40m or 20m CW Transceivers.**
Both models now available with full vfo control and semi-break in. 5 Watts£209
- Jim 80m, 40m or 20m SSB/CW Transceivers.**
Complete in every respect inc. CW button and internal mic. 2 Watts output.....£289
- Ramsey 80m, 40m, or 20m Tx. kits.**
A complete kit with board, components, controls and xtal. 1 Watt output.....£31.95
- Ramsey DC 80m, 40m, or 20m receiver kits.**
All you need to build a simple hf receiver that will copy CW, SSB and AM.....£31.95
Ask for QRP leaflet

ALINCO EAR-TALK

£29.95



- * Matches DJ-580E/DJ-180E
- * MATCHES DJ-F1E/DJ-S1E
- * PTT Micro Switch
- * Gain Control

Amazing value. Plugs into ear and works as earphone and also as a microphone picking up voice vibrations. The audio quality is superb. Comes complete with ALINCO plugs and is ready to go. You won't find a lower price

JUST ARRIVED!

MFJ-1278BX £339



Now with FACTOR!

The world's best selling data controller now gives you FACTOR plus 9 other modes. You get AMTOR, RTTY, ASCII, CW, FAX, SSTV, Navtex, Contest Keyer. Now with free PSU.

Multicom 1289M 3.5" Software
now in stock at £69.95

BEST VALUE

DJ-180EB

£209



- LCD display
- 10 memories
- 2 Watts out
- 5 Watts (12V)
- Ni-cad pack
- AC charger
- Auto power off
- Battery saver
- 5kHz-25kHz steps
- Helical aerial
- Memory expansions
- 12 month warranty



DJ-F4E 70cms
Model £299

BEST SELLER

DJ-580 SP



- PHONE FOR OUR FULL PRICE LIST**
- £449**
- 2m/ 70cms Dualband
 - CTCSS Built in
 - Cross Band Repeater
 - Receives Airband, Marine Band, Cellphones
 - 42 Memories
 - Complete with NiCads and charger
 - 8 scanning modes

Send for glossy brochures you're safe with Alinco!

DIAMOND

CP-6 £279

- Power: 200W
- Impedance: 50 Ohms
- VSWR: Less than 1.5:1
- Length: 4.6m
- Radials: 1.8m approx.
- Weight: 4.9kg
- Wind Rating: 90mph
- Mast Fixing: 1.5"-2.25"
- Socket: SO-239

The ideal base station aerial for all those with restricted space. It comes absolutely complete including rigid radials. The low angle radiation of the CP-6 makes it superb for DX working. Easily adjusted, it provides very low VSWR thanks to the matching section which also reduces static. Ruggedly built, it comes with all the necessary clamps for immediate erection.

Also Available without 6M CP5
£265

New items

- HB-400** Clips onto any plastic vent grill and holds hand-held in place, amazing little accessory£13.95
- AB-88V** Miniature magnetic mount with BNC socket and plug. For instant handy mobile but you helical on the mag£29.95
- EP-300** High quality earclip pieces as supplied to the police. Zero fatigue.....£13.95
- HX-9000** High gain dual band helical for 2m and 70cms hand-helds 2m - 2dB 70cms - 3.8dB. Total length is 19 inches. Also wideband receiver centred on 150/300/450/900MHz.....£29.95
- HX-7000** 7" version of above.....£19.95
- MUJ-564** Looks like the Vibroflex paddle keyer in every way but is made in the Far East and only costs£59.95
- P-300** 30 amp power supplies in stock. Made by Revex they are the heaviest duty you have ever seen!.....£189.95

HANDY POWER METER

REVEX W-160 £49.95



- 2m/70cm Post £3
- Power/VSWR
- 15/60W FSD
- Cast Alloy • SO-239

Revex make superb Power Meters for industry. Designed for the Amateur market, the W-160 is ideal for mobile or portable use. Very compact and very accurate.

Kenwood HF

NEW! TS-50 £Phone

The amazing 100W mobile rig. No bigger than many 2m FM boxes it give you all hf bands. 1.8-30MHz plus 500kHz-30MHz receive! SSB/CW/FM/AM. Memories, Dual VFO, Scan, Noise Blanker etc.



TS-450S £Phone

1.8MHz-30MHz 100W transmit plus receive 500kHz-30MHz. Optional ATU, triple conversion, IF shift, notch filter, dual mode noise blanker, reverse CW, CW pitch control, 100 memories. Send for details.



TS-850S £Phone

The most popular 100W transceiver in 1992 SSB/CW/AM/FM super dynamic rx range. IF slope tuning, IF notch filter, tx monitor, true rf speech processor, full break-in CW, 100 memories and more!



Free Credit! On HF Transceivers

HANDY STAND HB-100



Your Handheld Becomes A Base Station!

It's so simple yet nobody ever thought of it until now! Comprises universal adjustable angle mount with rubber feet and none scratch surface. BNC lead and SO-239 base socket. The smartest gadget we've seen for years.

£29.95 Post £1.50

G5RV With Compact Option!

Full Size 80-10m 102ft £21.95
Half Size 40-10m £19.50

COMPACT OPTION

Using our EL-40XC coils you can operate the half size version on 80 metres without affecting its performance on the other bands. The length is increased by only a few feet but as this added length of wire may be dropped vertically at the end, the overall length remains the same. 80-10m in 66ft of space! Coils £19.95 per pair.

Model	Deposit	Monthly
IC-765	£595	£200
IC-737	£295	£100
IC-279	£257	£86.50
IC-R7100	£279	£93
TS-950 SDX	£741	£246.50
TS-790E	£359	£120
R-5000	£198	£66.75
FT-990	£479	£160
FT-990DC	£430	£143.25
FT-890	£277	£91.50
FT-890TU	£315	£105
FT-747FX	£176	£58.25
FRG-100	£116	£40.25
AL-20BX	£299	£100

Payments based on 12 monthly instalments

"It's Fantastic!" Optoelectronics

2300
1MHz - 2.4GHz
Can read a 2W signal frequency at over 100ft!
With 25 Watts
.. WOW!
Simply switch on and connect an aerial to read
£169.95
£3 P+P

frequencies from local transmitters. This is like no other unit you have ever seen. It's absolute magic!
• HIGHLY ACCURATE
• COUNTER • BNC AERIAL SOCKET • INTERNAL NI-CADS
• AC CHARGER • VARIABLE GATE TIME • HOLD FUNCTION
• AMAZINGLY SENSITIVE!

MFJ-948

ATU
£149



300Watt ATU that matches long wires. 50m feed, balanced feed etc. and provides aerial switching, crossed needle VSWR and power meter.



G5RV Tuner £71.95

The G5RV is a popular all-band antenna but whether you feed it with balanced feeder or coax cable, it is essential to use an ATU to get maximum power transfer, particularly with solid state rigs. This ATU offers the perfect solution and is rated at 200 Watts. Why compromise performance? Make your antenna efficient and order this model MFJ-901

Head office: Retail and Mail Order: 22 Main Road, Hockley, Essex SS5 4QS.

Tel: (0702) 206835/204965. Fax: 205843

Retail only: 12 North Street, Hornchurch, Essex. Tel: (0708) 444765

ALINCO
ALINCO ELECTRONICS

UPDATED

**2M & 70cms Dual
Bander DJ-580SP**

£449.95
inc VAT

NOW WITH FULL CT CSS

The DJ-580SP handheld is the most advanced design ever offered to the radio amateur. Building on the winning formula of the DJ-560E, ALINCO have now reduced the size dramatically and introduced a combination of innovative features that will make your operating even more fun and certainly more versatile.

It goes without saying that ALINCO offer you all the standard features you expect from a hand-held including dual watch, dual controls, scanning, searching, priority, etc. Of course ALINCO's standard of engineering and reliability is now becoming the envy of its competitors. (They're also pretty envious of ALINCO's prices!) Naturally you get a full 12 month warranty including parts and labour. It's the extra features that really make this a winner.

For example you now have ALINCO's patented circuit that retains full operation with dry cells even when battery voltage falls by 50%. Great for emergency applications. You get a programmable auto power off feature, battery saver, digital telephone dialler and three output power levels. And we've only just started! Key in a special code on the keypad and your rig will turn into a fully operational automatic crossband repeater. Key in another code and you will open up the receiver for a.m. airband reception and frequency segments up to 950MHz! You can even use the DTMF feature to send and receive two digit code messages.

To learn more about the transceiver that has already taken the Japanese and American markets by storm, phone or write for a full colour brochure.



"The Most Comprehensive Specification Ever Offered!"

Available direct or from your local dealer

**Auto repeater mode
AM Airband Reception
Expanded Receive to 950MHz**



Specification

Tx	144-146MHz 430-440MHz
Rx	AM 108-143MHz FM 130-174MHz FM 400-470MHz FM 810-950MHz
Steps	5, 10, 12.5, 20, 25kHz
Memories	42
Power Output	2.5/1.0/0.3 Watts 5 Watts with 12V DC
Scan	8 Modes
Tones	1750Hz plus DTMF and CT CSS built in
Sensitivity	12dB SINAD -15dBu
Size	140x58x33mm
Weight	410g
Accessories Supplied	Ni-Cad pack, AC charger, belt clip, carry strap, dual band antenna and CT CSS unit.

**NOW WITH
FREE
CT CSS
UNIT**

WATERS & STANTON ELECTRONICS

22 Main Road, Hockley, Essex. Tel: (0702) 206835. Fax: (0702) 205843
 Retail and Mail Order: 22 Main Road, HOCKLEY, Essex SS5 4QS. Tel: (0702) 206835 / 204965
 Retail Only: 12 North Street, HORNCHURCH, Essex. Tel: (04024) 44765
VISA & ACCESS MAIL ORDER: 24 Hour Answerphone. Open 6 days a week 9.00am - 5.30pm
 Rail: Liverpool Street/Hockley or District Line/Hornchurch

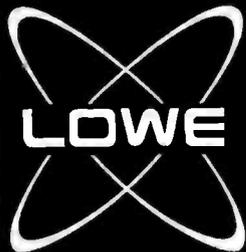

LOWE ELECTRONICS

The Professionals in Amateur Radio

KENWOOD'S TS50S

NOW YOU CAN REALLY GO HF MOBILE!

Kenwood's new mobile HF rig has caused a real stir in the market place. At last, an HF rig that will fit under your car's dash and still leave room for a passenger! Let's face it, the so-called HF mobiles that have been available of late have hardly been portable, let alone mobile, but the new **TS50S** will set new standards in size and performance. You can really do that DXpedition now as you can take the rig *and* the auto ATU as hand-luggage!



Quite how Kenwood have squeezed so much into such a tiny package, I can only marvel at. They haven't, however, skimmed on performance: All modes, gen. cov. RX, 0.25µV sensitivity on ssb, a dynamic range of 105dB and a full 100W output.

Words are not enough but we'll be happy to send you the brochure. Best of all, pop into one of our many branches and try one out.

Take some money

though – it is seriously tempting!

**COMING
SOON**

A LOWE ELECTRONICS EXCLUSIVE . . .

The KENWOOD TS450SDX™

A DXER'S DREAM FOR THOSE ON A BUDGET!

Full details for personal callers at any of our branches

Colin G3XAS at
BOURNEMOUTH
27 Gillam Road,
Northbourne,
Bournemouth
BH10 6BW
Tel: 0202 577760

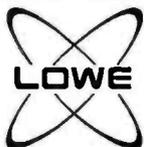

Dave G4KFN at
NEWCASTLE
Newcastle Airport,
Woolsington,
Newcastle Upon Tyne
NE20 9DF
Tel: 0661 860418

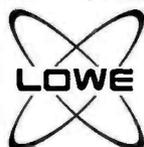

Tony G4CYE at
BRISTOL
79/81 Gloucester Rd,
Patchway,
Bristol
BS12 5JQ
Tel: 0272 315263

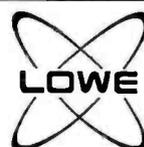

NEW

Fred G4RJS at
LONDON
223/225 Field End Road,
Eastcote,
Middlesex
HA5 1QZ
Tel: 081 429 3256

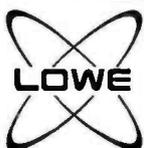

Tony G4NBS at
CAMBRIDGE
162 High Street,
Chesterton,
Cambridge
CB4 1NL
Tel: 0223 311230

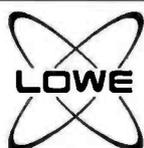

Sim GM3SAN at
CUMBERNAULD
Cumbernauld Airport,
Cumbernauld,
Scotland
G68 0HH
Tel: 0236 721004

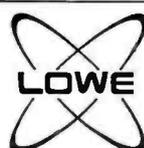

Head Office
Main Showroom
and Mail Order

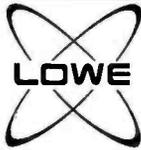

DERBYSHIRE

Here to help you are:

Rob G8MPT, Bill G8LXN
Beryl G7LME, Julie
Tom G6PZZ, Richard G3OQT
John G3PCY

Chesterfield Road, Matlock,
Derbyshire DE4 5LE
Tel: 0629 580800
Fax: 0629 580020

Steve G6URJ
KENT
Chatham Road,
Sandling,
Maidstone
Kent ME14 3AY
Tel: 0622 692773

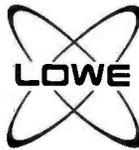

Tom G4LAR at
LEEDS
34 New Briggate,
Leeds,
LS1 6NU
Tel: 0532 452657

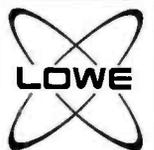

Steve G1WSY at
HEATHROW
6 Cherwell Close,
Langley,
Slough, Berks
SL3 8XB
Tel: 0753 545255

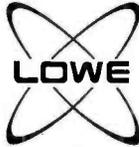

NEW BRANCH

DEREK G7ESZ
& Peter G6ZKO
The Basement
Royal Fleet Club
Devonport, Plymouth, Devon PL1 4PQ
Tel: 0752 607284



KANTRONICS

WORLD LEADERS IN DIGITAL COMMUNICATIONS

Once again Kantronics assert themselves as leaders in the world of digital communications. The ever-popular **KAM** has been fully upgraded to meet the demands of the latest digital modes. The new **KAM Plus** will become the standard by which all the others are judged, and the new facilities now include:

- **New User and Expert command sets**
- **On-line help messages for each command**
- **128K RAM**
- **1 Megabit EPROM**
- **Socketed lithium battery to back up RAM and on-board clock**
- **Expanded personal mailbox**
- **PACTOR now fitted as standard (V6.1)**
- **Enhanced CW operation – dot/dash weighting, Farnsworth spacing, tone transmission, and programmable CW filter bandwidth and centre frequency**
- **Programmable mark and space tones**
- **Extended RTTY and AMTOR character sets**

The **KAM Plus** should be available about now, but you don't need to throw away the old one! Simply buy the new **KAM Expansion Board** to upgrade to

all the new features. Both still run with Hostmaster software, now available for the PC, C64 and the Macintosh.

The **KPC3** continues to be the world's most popular VHF TNC. Designed to be user friendly (even to new Packeteers!), this amazing TNC delivers high performance in a very small package. It's less than half the size of its nearest rival but manages to pack in many more features.

The **KPC3** features an improved DualLevel™ command set that gives new users just 23 commands (all most people will ever need!) that get you up and running but with the full 130 plus commands available in Expert mode for those wishing to exploit the full potential of Packet.

The power consumption is so low it can be run from a PP3 battery, ideal for portable operation and Raynet use. Runs on 6–25V.

Additional features include Kantronics PBBS with reverse forwarding, message header editing, a mail waiting led, remote sysop access and Kantronics KA-Node. Kiss mode and Kantronics Hostmode are also included for TCP/IP compatibility and advanced operation. If that's not enough, it also decodes WEEFAX with appropriate software.

Hostmaster software expandable RAM and Real Time Clock are a few of the options.

FULL DATASHEETS AVAILABLE ON REQUEST

Some people still regard Packet as a difficult mode to operate (probably when they see their friends TNC manuals! Don't worry, it's a lot easier than you think! We'll also help you out by providing an RS232 lead, a lead to your radio and some free terminal and fax software to get you on the air with the minimum of fuss and delay. Ask for your **FREE Packet Package** when buying a TNC at any of our branches. Don't forget our Branch Managers if you need help in setting up – many of them have been doing this for years and will happily help you out.

Specialist help available at our **Maidstone, Cambridge, Cumbernauld and Matlock branches.**

0302 325690

Alan Hooker

Radio Communications



42 Nether Hall Road, Doncaster DN1 2PZ

Open: Monday-Saturday 10-5pm Closed Thursdays

Friendly Service

KENWOOD



TS850SAT • TS950SDX
TS450SAT • TS450S
TS50S • TS690S

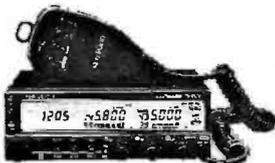

TM741E • TM732E • TM241E



TH78E • TH28E

YAESU



FT1000D • FT1000
FT990 • FT990DC • FT890AT
FT890 • FT747GX • FT736R



FT2400H • FT5100 • FT5200



FT411E • FT415
FT470 • FT530

ICOM



IC765 IC729 IC737



IC3230H • IC2410H • ICR7100
IC229H • IC228H • IC28H

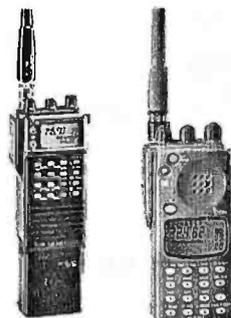

ICW2E • IC2SRA
IC2SE • IC2GE
IC24E • IC2E

ALINCO



DR599E



DR119E • DR1200E

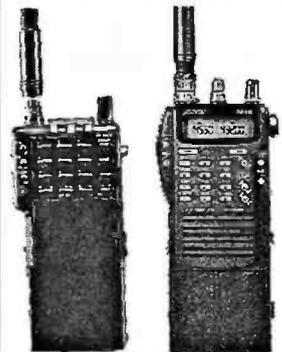

DJF1E • DJ180
• DJ580E

PACKET

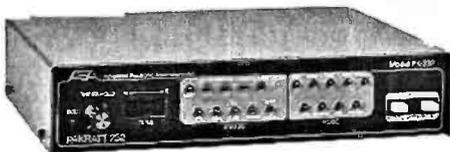

AEA PK232 • PK88 • AEA-FAX



THE 'RIG SAVER'

SLIMLINE ■

Allows you to safely mount your hand-held or mobile radio where you can see the controls

£29.95 + £2p&p

HEAVY DUTY ■

- Mounts any single flat surface.
- Adaptable to any vehicle or station use.

Construction made of high quality aluminium.

£36.95 + £2p&p

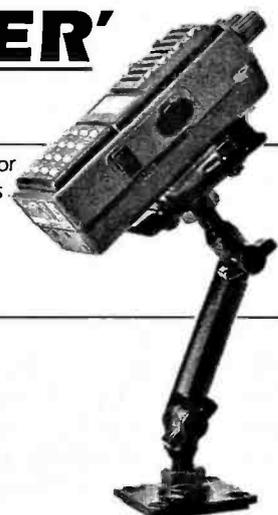

Summer is here, and we're rapidly approaching the peak of the rally season. The trouble is, there seems to be an overwhelming choice of rallies to attend!

Personally, I've always enjoyed a good rally, and I'm often able to find components for projects. Mind you, there always seems to be a mad scrum at most rallies, and even being a tall person doesn't help at some locations.

Recently, I have had several readers write to me complaining about the crowded conditions at rallies. Most of the complaints have also mentioned the costs involved, and that they don't seem to enjoy the average rally.

So, just what do we require from a rally? Is it the chance to meet old friends, buy bargains or just have a day out with an amateur radio theme? To answer to my own question, I really feel that your replies will be as varied as radio amateurs are in their own interests.

But, looking back at mobile rallies of 20 years or so ago, I feel that we've lost a great deal. In those days, in addition to trade stands a rally was still an ideal opportunity to meet old friends, make new ones and compare your mobile installation with others.

Keylines



Despite my enjoyment of the bargain-hunting aspect of the average rally, I think that there's definitely something missing from many events. All is not lost though, because we can do something about it and make the most of the day in the same way the QRP Conventions are doing so effectively.

Memories of mobile rallies from the early 1960s and 1970s came flooding back when I attended the 1993 Yeovil QRP Convention. There were talks, demonstrations and excellent lectures, plus excellent trade stands. And it was the same at the Rochdale Mini QRP Convention in October last year - I thoroughly enjoyed myself.

So, perhaps it's time to look back and breathe new life into your local mobile rally. After all, it should be an enjoyable time for everyone, whether they're buying, chatting, or just coming for a day out. Let's see a few more of those 'Best Mobile Installation' and 'Longest Distance Travelled' competitions and specialised talks again. Make **your** rally a day to remember!

Rob Mannion G3XFD

WORDSEARCH

X	E	A	K	R	A	C	S	H	S	I	H	F	N	D
F	Q	U	K	K	I	N	Q	T	B	F	B	R	J	D
L	Q	T	V	B	A	H	N	W	A	E	W	G	C	Q
I	Y	D	M	K	U	P	V	E	L	N	P	A	K	X
Z	S	O	X	M	R	R	F	O	T	U	D	D	M	V
C	H	L	S	Y	A	I	P	L	X	N	S	I	U	I
R	M	I	O	T	I	O	D	G	V	A	A	Y	N	T
R	Y	O	I	P	N	E	H	N	D	A	N	U	Z	G
W	E	O	D	O	E	J	K	L	A	C	R	Y	L	V
F	K	S	M	N	D	R	T	F	Z	O	W	C	F	V
E	E	Q	Y	I	I	L	A	C	I	T	R	E	V	Y
V	U	E	P	L	A	W	J	F	U	G	P	Q	J	B
A	V	O	D	C	A	L	D	C	U	A	T	X	R	N
W	L	E	H	E	Q	N	E	E	K	V	U	Y	E	V
E	B	E	U	I	R	K	A	S	U	H	Z	T	T	S

Words To Find

- | | | |
|------------|------------|------------|
| ● Analyser | ● Ratio | ● Antenna |
| ● Wave | ● Rhombic | ● Windom |
| ● Dipole | ● Vertical | ● Standing |
| ● Feeder | ● Monopole | ● Sloper |

Wordsearch rules: Twelve different words have been hidden in the letter grid. They have been printed across (forwards or backwards), up and down, diagonally, but they are always in a straight line without odd letters in between. You can use the letters in the grid more than once for different words. Once you have found all 12 words, mark them on the grid and send it, along with your name and address (photocopies accepted with the corner flash) to our editorial address, marked 'Competition Corner' Wordsearch August '93.

Name.....
 Address.....

First Prize

A year's subscription to *Practical Wireless* or a £20 book voucher.

Second Prize

Six month subscription or £10 book voucher

Subscription Voucher

Send your entry (photocopies acceptable with corner coupon) to: Competition Corner, Wordsearch Competition, August '93, PW Publishing Ltd., Arrowsmith Court, Station Approach, Broadstone, Dorset BH18 8PW. Editor's decision on the winner is final and no correspondence will be entered into. Entries to reach us by Friday 20 August 1993.

Receiving You



Send your letters to the editorial offices in Broadstone. They must be original, and not duplicated in any other magazine. We reserve the right to edit or shorten any letter. The views expressed in letters are not necessarily those of *Practical Wireless*. The Star Letter will receive a voucher worth £10 to spend on items from our Book or other services offered by *Practical Wireless*. All other letters will receive a £5 voucher.

Bouquets not Brickbats

Dear Sir

We hear all too often of criticisms of retail dealers but to a lesser extent those who give service well above the norm tend to blush unseen.

Through your pages I would like to express my appreciation of Siskin Electronics for their help freely given on a number of occasions. The first (some time ago) was rewiring for me one of the very small plugs from my computer into my packet TNC that had come adrift and which due to poor eyesight, I could not do myself. I telephoned explaining the situation and Siskin were all too willing to rewire it for me completely without charge, which they did for me by return of post.

After a recent change of computer they sent me two disks to suit my new computer, also free of charge and did not even ask for postage. I also ordered a specially wired Centronics lead by FAX at 2pm one afternoon and it arrived first class post the next morning! I have also telephoned them on several occasions over the past fortnight for information on setting up my new computer for packet and much helpful advice has been given to me on each occasion, even though they did not supply my computer.

I feel such helpfulness, that carried no pecuniary advantage to Siskin other than a very satisfied customer, should not go unnoticed.

M. P. Squance G3HTB
Bournemouth

★★★★ Star Letter ★★★★★

Rig Prices

Dear Sir

I am currently a Novice and am SHOCKED at the prices of rigs. For instance, in the May edition of *PW*, an Alinco DR-599E 144/430MHz was £699.95! And yet on the opposite page, there was a same make and specification hand-held for £499.95. Surely the hand-held would be more expensive as there are more things to cram into a smaller space?

But why, oh why, are 144/430MHz rigs so expensive, I mean for a Kenwood rig you are paying up to £800!

What us Novices want is not CTCSS or d.t.m.f. but a fool-proof, low power rig (most of them come with an amp, no use to us Novices, our max power is 3 watts!). If we are to attract newcomers to the hobby, we must make sure they have a rig to operate for I am sure many of them, faced with the daunting task of buying a rig, are frightened away.

Tom Girdler
Loughborough

Receiver Project

Dear Sir

Thank you for continuing with my favourite magazine, I've read *PW* for many years, I can't quite remember Mr Camm but almost.

I read C. D. Barnard's letter, in the April *PW*, with interest, I also recollect that particular old receiver project, and would enjoy an updated version. I think that you should make another free gift of the trimmer tools that everyone remembers, but has lost.

On the point of the no code licence, I just can't imagine life without it. As a valid and viable method of communication, we all know c.w. can reach the parts others can't, so why drop it?

A. P. Holden 2E1BJC
Ipswich

A Change of Program

Dear Sir

I thought that you would be interested to know that quite a few errors have come out in the published program 'Basic Program for Morse in the May *PW*.

Subroutine 120-170. This would have been better in capitals to distinguish between L's and ones, in any case several of the codes were incorrect.

The other corrections are as follows:

280 & 560	Change all FLAG1 into FLAG2
310	Change second equals into plus signs
400 & 440.	Change pound to cross-hatch sign
510	Flag = 1 not minus 1
540	Change third & forth FLAG1 into FLAG2
590	Should be: PLAY S\$ + SYM\$ (NN): RETURN

The subroutine 120-170 is a bit of a typists nightmare and does not achieve the correct spacing of one dot between dots and dashes. I enclose a version in which the data is simply a Morse code entry and that also gives the correct spacing. As you would expect, it does sound better. With this version line number 310 must read MLT instead of MST.

G. Tulley
North Wembley

(Ed: If readers send an s.a.e. marked Morse Program to the Editorial Offices, we will dispatch a copy of Mr Tulley's program).

Spread Spectrum

Dear Sir

I was interested to read in Phil Cadman's 'Spreading The Spectrum' article that he was unaware of the experimental transmission of direct sequence spread spectrum signals I have carried out.

The Radiocommunications Agency have permitted me to experiment with spread spectrum since July 1988 under a special authorisation under the terms of my amateur radio licence.

The first UK spread spectrum amateur transmission on 435MHz occurred on 19 January

1992 after considerable research, design and bench testing. This achievement was reported in the RSGB magazine *RADIO COMMUNICATION 'Technical Topics'* section March 1992.

A more advanced direct sequence system using digital voice modulation is under development and field tests are

planned for this summer.

I hope this information may indicate that the Radiocommunications Agency has a positive approach to the use of advanced modulation techniques and that the UK is not too far behind the US in technical developments.

James Vincent G1PVZ
Yeovil

Illegal 'Phones

Dear Sir

Something caught my eye in the May PW.

The reply from the RA about interference from illegal cordless 'phones is the complete opposite to my understanding of radio law. Was the spokesman sufficiently knowledgeable, or has it all been changed? Sale of non-licensable radio equipment is not illegal and cannot be stopped apart from some very specific exceptional cases (such as illegal CB sets that amateurs wish to convert to 28MHz). The RA therefore is unlikely to have the right to remove illegal 'phones at the point of sale. However, transmission of non-approved frequency is an offence under the 1949 Act and this is, as I understand it, therefore the only legal sanction that the RA can bring to bear.

Also, isn't broadcasting the primary user within it's h.f. allocations? Does this also afford it protected status?

Lastly, 'phones on illegal frequencies are hardly likely to be type approved (with a 'green circle' emblem) for connection to the public switched telephone network. Anyone using one is thus infringing this other piece of legislation, too! I'm sure the problem can be stamped out if willingness is there.

**G. Manning G4GLM
Edgware**

Lifetime Subscription

Dear Sir

Having won a lifetime subscription to *Practical Wireless* at the Dayton Hamvention 1992, I would like to thank all of you for an informative magazine.

After I have thoroughly read the issues, I intend to donate the issues as they arrive to the Dayton Amateur Radio Association for the benefit of all the club

Too Late

Dear Sir

For many years I have enjoyed scanning the airways in search of interesting transmissions. However, a pattern is evolving in my shack that the higher the technology used, i.e. 'black box' receivers, audio filters, data decoders, v.d.u.s and scanner controllers, etc., the longer it takes to actually tune to a signal.

Many times I have set up my data decoder, tuned my receiver to give the required audio and, you've guessed, the signal stops. I wait, but to no avail! This not only happens to data but to R/T also. I've heard so many "....listening out's" or "standing by's"!

I should therefore like to promulgate G.I.R.L. or Garnett's Inverse Reception Law stating that there is an inverse relationship between the complexity of the receiving equipment and the duration of transmission of a given signal, given that signal being '5 x 9' and the final 'over' illustrated by:

$$-t = 1/\text{£} \times V$$

Where a £ = cost in whole £

V = No. of equipment items requiring manual control

t = duration of remaining transmission

I trust that this letter is taken in the spirit of jest. It in no way reflects upon the quality of my equipment, I just should have turned on earlier.

**John Garnett
Truro**

members. I particularly like the constructional articles and whilst my skills at designing circuits are limited, I find I wield a pretty fair soldering iron and have built several kits with good success. I am also finding the current series of articles on QSOs in Foreign Languages very interesting. Too often we expect everyone to speak our native tongue. I believe some conversation no matter how poorly pronounced in the language of those on the other end of the QSO helps make friends. After all isn't that what what Amateur Radio is all about?

Once again thank you for the subscription and who knows maybe one of these days I can arrange a visit to "Jolly Old England".

**Larry Apple N8MYQ
USA**

Non-Activity on 430MHz

Dear Sir

I am a licensed Novice and I am very concerned about the activity on the 430MHz band, or perhaps more to the point

the lack of it. Perhaps that's why we were allocated part of it, so we can't disturb the high power v.h.f. users on 144MHz. Isn't it about time we were allocated a part of this band?

In recent weeks I have made no contacts, which is a little disturbing as I visited the London Amateur Radio & Computer Show and parted with some hard earned cash on a new rig. At first I thought it was not working! Maybe I am sitting in a radio black hole.

If there are any amateurs out there please use 430MHz and give us novices a chance. If you do hear that distressed voice begging for contacts please reply to me.
**David Childs 2E1BJS
Southampton.**

Pirate Radio

Dear Sir

Whilst listening to GB3SN last week, I noticed a pirate radio station operating. When another station asked him where he got his radio, he replied that he had bought it recently. In the interests of preventing pirate radio stations operating, I think that when you are buying a transmitter you should have to produce identification and your validation document at the time of purchase. Anybody who fails to produce the necessary documents should not be allowed to purchase transmitters.

Lawrence Jeffries G7OAR, Bransgore

Yet Another Contest!

Dear Sir

I remember the first time, as a short wave listener, that I heard a contest in operation. As I listened, I thought, 'Great Idea! Must have a go when I am licensed'.

As the years rolled by, the number of contests grew from a handful to the present day 127 in the 'contest' year. Nothing could be calculated better to kill the joys of Amateur Radio. When the weekend arrives, most amateurs think about looking for something interesting and exciting, this being the only time most of them have for amateur radio. Switch on and what is heard? 'Contest, QRZ contest-you're 5/9 336' or something like that! The band is bedlam, there are stations over stations over stations, and nowhere to work what I call 'sensible' radio. Call a contest worker and you are always '5-9'.... try him next day and the reply is 'I am sorry old man but I do not read your signal, you are only 3 by 5!'.

What is the point of so many contests? Can anyone give me a convincing explanation? Does it really add to the self-learning of the radio amateur? Have they all given up normal conversation to go bananas for 24, sometimes 48 hours? I have been licensed for quite some time now, and as far as I can ascertain through countless contacts world-wide, the number of amateurs interested in contests is less than 20% of the amateur population. So, why not restrict all contests to 20% of whatever band they hold the contest on? Or perhaps the operating time could be reduced to 20% of what is now used? Or restrict the contests to one band at a time? Or perhaps stop them altogether? There is nothing worse than the QRM from stations working contests, for 'as sure as eggs is eggs', they will have your frequency if you are not in the contest! And when I tried to demonstrate, this weekend to an interested listener what amateur radio is all about, the comment was, "Oh! So that's what you do all day?" (Sheer bewilderment!).

So come on, contest organisers, get your acts together for a couple of big ones, and cut out all the in-between superfluous stuff, so that we can get on with sensible talk about real amateur radio. I am not alone in wondering whether or not to pay for next year's licence, certainly not to listen to perpetual contest rubbish! Or perhaps the answer is to allocate a 'Contest Band' where amateurs who are bored with ordinary communication can go and talk to a thousand amateurs in one day! and every day of the week, if they so desire. In my opinion, contests are a drag and a killjoy.

**D. Bedford
Stratford-upon-Avon**

Newsdesk '93

Special Event Station GB4ATC

The Air Training Corps will be operating a h.f. and 144MHz special event station - callsign **GB4ATC** from July 20-31. The station will be operational between 1100 and 2200 for the duration of the 1993 Royal Tournament, Earls Court.

There will be air cadets on hand to pass and receive messages. There will also be a demonstration station operated by the cadets using their allocated ATC frequencies, v.h.f. and h.f. will be in use.

For further details please contact **Malcolm Wood: Tel. 071-438 6053 daytime or 081-363 0727 evenings.**

Summer Constructors' Catalogue

Cirkit have just published the Summer 1993 edition of their Electronic Constructors' Catalogue. This 224-page edition includes 25 product sections and over 4000 product lines. As well as new products, a section on low cost alarms, scanning receivers and accessories, the latest Velleman kits and plenty of new components are included. The catalogue costs £1.90 and is available from most larger newsagents or direct from **Cirkit Distribution Ltd., Park Lane, Broxbourne, Herts EN10 7NQ. Tel: (0992) 441306.**



Proposed Repeater For South Hampshire

A steering group has been set up to try and put a 430MHz repeater on air to provide 'blanket' portable, mobile and base coverage of Southampton, Eastleigh and Chandlers Ford.

The group comprising of **G4MYS, G4HCL** and **G0AFF** have requested a provisional callsign of **GB3EA** (Eastleigh), with channel RB8 proposed. Further information and comprehensive coverage maps are available from **South Hampshire Repeater Steering Group, PO Box 73, Eastleigh, Hampshire SO5 5WG.**

Apology

We apologise to Martin Lynch for the similarity in typesetting style between his advertisement and that of Photo Acoustics Ltd, which also appeared in the July issue of *Practical Wireless*.

Martin would like to point out that there is no connection between himself and Photo Acoustics.

Practical Wireless apologises to its advertisers and readers for any confusion or inconvenience caused by this.

New Style Antenna Mounting

American company G & P Engineering have announced a new-style antenna mounting system called the 'N-PAM'.

Designed with American-style roofs in mind, this unit will mount on a house roof without the need to drill holes and is mountable on roofs with flat to 45° pitch.

The basic system includes single or dual tray units with a 50mm mast that is 914mm in height, and is suitable for use with a tri-band/v.h.f./u.h.f. system. Other options include a 1524 or 2134mm mast. The 2134mm mast allows for the use of the largest Oscar antenna system or stacked Yagis.

There are two factors which determine the size of the antennas that can be mounted on the unit and these are:

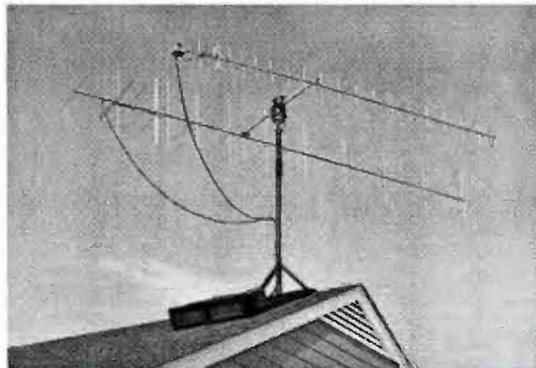

antenna square footage wind load and 100 year wind speed chart.

The mounts are made of steel and are primed and painted with a black epoxy paint to blend with most roof tile colours.

Further details and a brochure are available from **G & P Engineering, 4943 Finch Court, Stephens City, VA 22655, USA. Tel: 010-703 8695 116.**

Guide to English Language Short Wave Broadcasts

The International Short Wave League have recently published their summer edition of *The Guide to English Language Short Wave Broadcasts*. The guide is comprehensive, practical and clear with the information presented in time order. (GMT/UTC) with

aligning programme time periods; country and station names; frequencies, and programme details such as news, features, sport, religious and World Service transmissions. All frequencies are given in kHz.

The guide which is in the form of a booklet is available for £1

or 2 IRCs from **International Shortwave League, 10 Clyde Crescent, Wharton, Winsford, Cheshire CW7 3LA** or from ISWL stands at rallies.



Lithium Cells

The Middlesex-based company Saft Nife has recently expanded its LS High Energy lithium range with the introduction of two new high-capacity, vented cells.

The LS14250 (half AA) and the LS14500 (AA) offer up to 20% more energy density at moderate and low rates.

Based on lithium thionyl chloride electrochemistry, the cells operate on a voltage of 3.5V (1mA at 20°C). The LS14500 nominal capacities exceed 2Ah and the LS14250 exceeds 0.9Ah. Both are fitted with a safety vent and a glass-to-metal seal as well as being TIG welded for complete sealing and to prevent leakage when used in harsh operating conditions.

The LS range will operate in temperatures ranging from -55°C to +85°C and is available as single cells or as customised battery packs, complete with diodes and fuses to protect against short circuits, overloads, over discharge and recharging.

The high energy, high voltage, light weight, reliability and safety of these cells can make them useful for electronic devices requiring long storage and operating life. Further details on these cells is available from **Saft Nife Ltd., Station Road, Hampton, Middlesex TW12 2BY. Tel. 081-979 7755.**



Converter Modules

Advanced Power Conversion Ltd. based in Hampshire, have recently introduced a new range of single and triple 200W output d.c. to d.c. converter modules, known as the APC 200 Series. Integrated magnetics and surface mount technology help to achieve exceptional power density and reliability. They say the power topology is a unique current fed, push-pull converter operating at a fixed frequency of 500kHz in the current mode.

The 200 Series is available in three input voltage ranges and can be used in parallel, series output configurations or stand alone units. They have an operating temperature of -20° to +105°C and can be p.c.b. or chassis mounted.

Each module has output short circuit protection, input transient voltage suppression and latched thermal and over voltage shut-down, making them useful in electronic, process, communications and manufacturing industries.

Further details from **Advanced Power Conversion Ltd., Unit B5, Armstrong Mall, Armstrong Mall, Southwood Summit Centre, Farnborough, Hants GU14 0NR. Tel: (0252) 371036.**

Newsdesk '93

Last Chance

Are you considering taking out or renewing a subscription to *Practical Wireless*? If you're quick you still have one last chance to subscribe at the old rates.

Despite the recent cover price increase we have been able to keep the subscription prices at the old rates of: £21 (UK), £23 (Europe), \$45 (USA) & £25 (Rest of World). However, as from 12 August 1993 these rates will be increasing, so don't lose out, take advantage of this money saving offer and subscribe today.

RAE Class

Midland ARS will be running RAE and Morse classes for the Autumn. Starting on September 15 they run until May 1994. The classes will be held at 60 Regent Place, off Caroline Street, Hockley, Birmingham, 7.30pm and are aimed at beginners. Further details from **John Crane GOLAI. Tel: 021-628 7632.**

Student's Tool Kit

Maplin Electronics have added a new 15-Piece Student's Tool Kit to their range of tools. Suitable for use in schools, colleges and by electronics hobbyists, the kit includes a 25W soldering iron with two interchangeable bits (flat and pointed), a detachable hook and small fold-up stand, desoldering tool, a supply of solder and a pot of flux.

For use on p.c.b. designs, a 'helping hands', a 'scraper' and a wire wrap tool are included and well as two crosspoint and two standard screwdrivers, a pair of pliers, wire cutters and a pair of tweezers.

The tools are housed in a smart carrying case with preformed sockets to help hold the tools in place.

This tool kit is available for £14.95 from **Maplin Electronics, PO Box 3, Rayleigh, Essex SS6 8LR. Tel: (0702) 554161.**



G3XJS Not G3XJJ

The editorial team sends its apologies to Peter Barville G3XJS, whose call sign we changed on the front cover of the July issue of *Practical Wireless*.

A slip of the editorial keyboard caused Peter to become G3XJJ instead of G3XJS. So, Peter, we hope you will accept our apologies for this slip up. We did get it right on the both the contents page and the article itself.

Trowbridge & District ARC

The Trowbridge and District ARC will be using the **GX2BQY/P** special event station call sign as part of the West Wiltshire '93 Trade and Commerce Exhibition on July 22 & 24. The station will be operational on h.f. and v.h.f. and will be sponsored to help raise money for the Wiltshire Air Ambulance Appeal.

When you're satisfied We're delighted!

DEAR MR. LYNCH,
 JUST WRITING TO THANK YOU FOR THE COURTESY
 SHOWN ME DURING MY RECENT VISIT TO YOUR
 NORTHFIELD STORE.
 BEING A NOVICE DX'er FROM THE STATES,
 I WAS CURIOUS TO LEARN THE VARIOUS TYPES
 OF EQUIPMENT USED BY THE ENGLISH TO CHANGE
 THESE ELUSIVE SIGNALS.
 KNOWING THAT YOU WERE WITH US
 A FEW DAYS AGO, I WAS OFFERING A WELCOME
 TO MY AERON-BORN WIFE.
 YOUR WARMTH AND SINCERITY WAS MUCH
 APPRECIATED AND I WISH YOU CONTINUED
 SUCCESS.

VERY TRULY YOURS,
 Brian E. Lockyer

Ref: MUTEK Front-end modification Kit.

Just to confirm my recent comments to you by telephone in regard to the
 I found the performance of the YAESU FT 736R to be very much improved
 after the modification, the receiver performance is now superb, as you
 have done the modification work myself and because of this, although I am not
 an expert, I was pleasantly surprised to find that the rig still worked
 perfectly. Many thanks for an excellent modification.

Dear Martin,
 S/H Yaesu FT26R, No. 1G064780, ML3971.
 Invoice No. 09705, 16/2/93.

This rig arrived back home this morning after
 a very long wait, and this is simply to thank you for your
 excellent service and friendly staff.

Yours sincerely,
 J.A. Burt

To Martin
 From Bob LEASK G4EEO.

Rig arrived safely - well packed - I'm impressed
 Thanks for your help

Dear Martin and Staff,
 I write to express my thanks and appreciation for
 the prompt attention I have recently received from you with regard to
 the fault on my FT-767GX, having regard to your busy week end at the
 Rally the ten days taken to locate the problem and effect a repair was,
 in my opinion, admirable.

Yours Faithfully,
 Len Lockyer. G4VRI

Martin Lynch
 286 Northfield Avenue,
 Ealing,
 London,
 W5 4UB

PLEASE FIND ENCL
 FOR £74.9- FOR AN ICOM
 THE R2000 IS OK. LOOKING
 THE ICOM SOON. THANKS
 HELPFUL ADVISE AND SAYING
 YOURS,
 DE G7 KMQ.
 C. MARTIN

Isn't it time YOU Up

286 NORTHFIELD AVENUE, EALING, LONDON W5 4UB

tisfied...

MARTIN LYNCH

G4HKS

THE AMATEUR RADIO EXCHANGE CENTRE

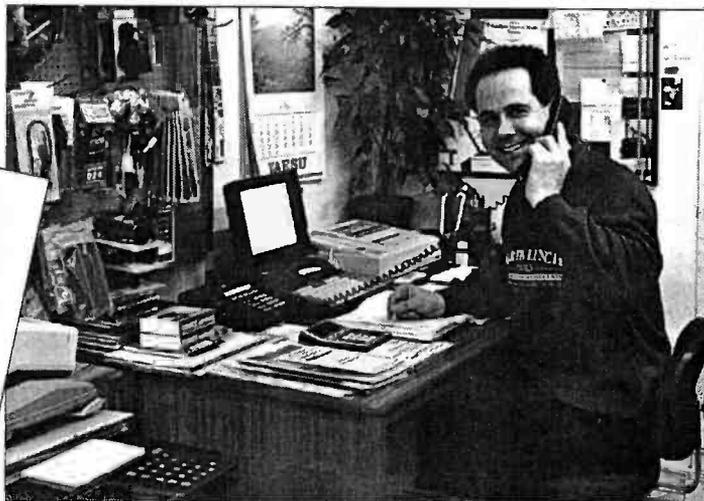

Martin Lynch started in Amateur Radio twenty four years ago and has been selling equipment for almost as long. Other companies may try and copy his ideas but they never emulate his dedication to customers. He does not offer day trips around service departments, which is probably why his turn-around & servicing

rates are the best in the U.K. A team of devoted enthusiasts offer advice based on experience, six days a week, under one roof. **MARTIN LYNCH.**

Just an up-to-date & successful business with traditional values.

Martin Lynch

Eating

That Icom Power lead

many thanks for lead - it arrived this morning I knew I could count on you!
When I get bored with this rig I'll be back to you for a bigger one!!

Martin G70CV

Dear Martin,

Please find enclosed a cheque for £19 in payment for a second hand YU-2 Vox headset (£15+£4). It was sent to me 29th after a telephone call.

none' service. I know I'll get a better service from you! Once again thank
C. Lile

bove kit.
oved
u know
without

repa.
promp

LOSED UNID
729 AND HERE
FORWARD TO RIZEVING
LOT FOR ALL YOUR
ME SOME CASH.

ut Lynch to the test?

Tel: 081 566 1120 FAX: 081 566 1207



Club News

Please send in all of your 'Club News' items to Donna Vincent at the editorial offices in Broadstone.

Antrim

Carrickfergus AG. Tuesdays, 7pm. Downshire Community School, Downshire Road, Carrickfergus. July 31 - Special Event Station at The Castle Green. **Gavin on (0232) 835650.**

Bedfordshire

Shefford & DARS. Thursdays, 8pm. Church Hall, Amptill Road, Shefford, Bedfordshire. July 8 - BBQ, 15th - Mobile DF Hunt. **Paul G1GSN on (0462) 700618.**

Berkshire

Maidenhead & DARC. The Red Cross Hall, The Crescent, Maidenhead, 7.45pm. August 1 - McMichael Rally, 5th - BBQ at Max G7DXCs QTH. **Neil G8XYN on (0628) 25952.**

Newbury & DARS. Wednesdays, 7.30pm. Bucklebury Memorial Hall. July 28 - Computers In Amateur Radio.

Reading & DARC. 2nd & 4th Thursdays, 8pm. The Woodley Pavilion, Woodford Park, Haddon Drive, Woodley, Reading. July 8 - RSGB Evening, Talk by Peter Chadwick G3RZP RSGB President, 22nd - DX Packet Cluster System. Provisional G3WGV, August 1 - Support McMichael Rally, 12th - HF SSB Contest And Club Members Discussion. **Nick Challacombe GOLGG on (0734) 722489.**

Buckinghamshire

Milton Keynes & DARS. 2nd Mondays. North Bucks Youth Sports Hall, Haversham Road, Wolverton, Milton Keynes. July 12 - Servicing And Amateur Radio Equipment by Castle Electronics, August 9 - RAYNET by G4NUG. **Julian Winson G3FGB on (0908) 611005.**

Cheshire

Mid-Cheshire ARS. Cotebrook Village Hall, Cotebrook, nr. Northwich, Cheshire. July 14 - Activity/On-Air Night, 21st - Microwaves by Mike G3PFR, 28th -

Club BBQ at Cotebrook. August 4 - Equipment Night. **Mike Baguley G7LQD on (0606) 331210.**

Stockport RS. 2nd & 4th Wednesdays, 7.45pm. Room 14, Dialstone Centre, Lisburne Lane, Offerton, Stockport, Cheshire. July 14 - Basic Research by Keith Twort G8CHY, 28th - Talk by Castle Electronics, August 11 - What Your Mother Never Told You About Multi-Tracking Recording by Howard Gregory. **Jim France G3KAF on 061-439 4952.**

Clwyd

Wrexham ARS. Maesgwyn Community Centre, Maesgwyn Road, Wrexham. July 20 - Field Evening, August 3 - Equipment Testing Evening. **Ian Wright GW1MVL on (0978) 845858.**

Derbyshire

Buxton Radio Amateurs. Lee Wood Hotel, Buxton, 8pm. July 13 - JOTA Discussion, 27th - Bring & Buy Sale, August 10 - Aerial Topics. **Derek Carson G4IHO on (0298) 25506.**

Derby & DARS. Wednesdays, 7.30pm. 119 Green Lane, Derby. July 14 - BBQ, Drum Hill Scout Camp, Little Easton, 21st - 144MHz Direction Finding Practice - Allestree Park, 28th - Technical Talk, August 4 - Rally Preparation Evening. **Hayley Winfield 2E1AJJ on (0773) 856904.**

Devon

Appledore & DARC (Devon). 3rd Mondays, 7.30pm. Appledore Football Clubroom. July 19 - Social Evening & Treasure Hunt. **Reg Lyddon G4ETJ, QTHR on (0237) 477301.**

Axe Vale ARC. 1st Fridays, 7.30pm. 'New Commercial', Trinity Square, Axminster, Devon. **Pat Cross G0GHH on (0297) 33756.**

Exeter ARS. 2nd Mondays, 8pm. The Community Centre, St Davids Hill, Exeter. July 12 - Engineering For Hams by Baz G0FGE, August 9th - EARs BBQ. **B. L. Bolt. (0392) 214204.**

Torbay ARS. Fridays, 7.30pm. ECC Social Club, Highweek, Newton Abbot. July 16 - HF DXing by Bob Whelan G3PJT. **W. Hipwell G3HTX on (0803) 526762.**

Down

Bangor & DARS. 1st Fridays, 8pm. Winston Hotel, Queens Parade, Bangor, Co. Down. **Des Buckley GI3HCP on (0247) 460251.**

East Sussex

Crowborough & DARS. Thursdays, 8pm. Plough & Horses, Crowborough. July 22 - Visit To Bredhurst For Equipment Testing. **Michael Smith G6UUU on (0892) 661807.**

Essex

Bishop's Stortford ARS. 3rd Mondays, 8pm. British Legion Club, Windhill, Bishops Stortford. July 21 - Briefing For The VHF Field Day, 19th - Quartz Crystals by M. Cracknell. **John Dudeney on (0799) 550313.**

Chelmsford ARS. 1st Tuesdays, 7.30pm. Marconi College, Arbour Lane, Chelmsford, Essex. July 25 - Colchester Radio & Computer Rally, August 3 - Gliding by Brian G3CVL. **Roy & Ela Martyr G3PMX & G6HKM on (0245) 360545.**

Greater London

Acton, Brentford & Chiswick ARC. 3rd Tuesdays, 7.30pm. Chiswick Town Hall, Heathfield Terrace, London W4. July 20 - Post, Lower Power Field Day. **Colm Mulvany G0JRY on 081-749 9972.**

Crystal Palace & DRC. 3rd Saturdays, 8pm. All Saints Parish Rooms, Beulah Hill, London SE19 (opposite junction Grange Road). July 17 - Family Day Out To The Imperial War Museum at Duxford, Cambridge. **Wilf Taylor G3DSC on 081-699 5732 or Bob Burns G300U on (0737) 552170.**

Edgware & DRS. Watling Community Centre, 145 Orange Hill Road, Burnt Oak, 8pm. July 8 - Antenna Systems & Discussion by John Plested G4GYS, 22nd - Morse Training Evening. **Howard Drury G4HMD on (0923) 822776.**
Greater Manchester

Manchester & DARS. Tuesdays, 7pm. Simpson Memorial Community Association, Moston Lane, Manchester. Free RAE courses & Morse tuition for members. **Barrie Langfield G3IOA on 061-681 5406.**

Tameside ARS. 2nd & 4th Tuesdays, 7.30pm. ATC Camp, Moorcroft Street, Droylsden, Tameside. **A. N. Laughlan G1YCM, 8 Kempton Close, Droylsden, Tameside, Manchester M35 7LJ.**

Gwynedd

Dragon ARC. 1st & 3rd Mondays, 7.30pm. Four Crosses Hotel, Menai Bridge. July 19 - Mr Donald Roberts GW0GHG Talks About His Adventures On A Recent Trip To New Zealand, 24th & 25th - GB2CPC Rare Breeds Event at Penrhyn Castle, August 2 - An Evening Of Amateur Radio Videos. **Tony Rees GW0FMQ on (0248) 600963.**

Hampshire

Basingstoke ARC. 1st Mondays, 7.30pm. Forest Ring Community Centre, Sycamore Way, Winklebury, Basingstoke. July 25 - 144MHz Direction Finding Competition OS175 Fox: Dave G4NIP, August 2 - Commercial Satellite Communications by Jim G4BEZ. **(0256) 25517.**

Itchen Valley RC. 2nd & 4th Fridays, 7.30pm. Scout Hut, Brickfield Lane, Chandlers Ford. July 9 - HF Propagation Part II, Predictions & Forecasting from Nigel Gerdes G7CAW. **Les Kennard G3ABA on (0703) 732997.**

The Three Counties ARC. Every other Wednesday, 8pm. Railway Hotel, Liphook Hampshire. July 10 & 11 - Field Radio & BBQ Weekend, location the White Horse Public House field at Priors Dean, August 4 - Computer Night. **Kevin Roche G8GOS on (0420) 83091.**

Winchester ARC. 3rd Fridays, 7.30pm. Red Cross Centre, Durngate House. July 16 - John Lepper G3JHL, August 20 - Social Evening With A Focus. **Peter Simpkins G3MCL on (0962) 865814.**

Hereford & Worcester

Bromsgrove ARS. 2nd & 4th Tuesdays, 8pm. Lickey End Social Club, Alcester Road, Burcot, Bromsgrove. July 13 - 144MHz DF Hunt, 27th - Technical Topics, August 10 - Safety In The Shack. **Mr D. Edwards G4ZWR on (0527) 546075.**

Vale of Evesham RAC. August 8 - The Annual Treasure Hunt, meet at Evesham Post Office. **Alasdair on (0386) 41508.**

Hertfordshire

Dacorum AR & TS. 1st (informal) & 3rd (formal) Tuesdays, 8pm. The Heath Park, Cotteswells, Hemel Hempstead. July 20 - Talk On VHF DF Hunting by S. White G3ZVV. **Dennis Boast G1AKX on (0442) 259620.**

Hoddesdon RC. Alternate Thursdays, 8pm. Conservative Club, Rye Road, Hoddesdon, Herts. July 8 - Social Evening, 22nd - Detection by Pat Brolan G1NPU. **Roy G4UNL on 081-804 5643.**

Stevenage & DARS. Tuesdays, 7.30pm. Stevenage Day Centre, Chells Way, Stevenage. July 13 - The Novice Course by Robert 2E1ARU, 20th - Satellites, The Conversion Of The BSB Dishes & Decoders by Rob G2BKZ, 27th - RAYNET by Gary G0ETA. **Neil Ravilious 2E1ASZ on (0438) 350882.**

Humberside

Goole R & ES. Fridays, 7.30pm. West Park Pavilion, West Park, Goole, last Fridays at the 'Black Swan Inn', Asselby. July 9 - Logfill, 16th - RSGB Video, 23rd - Planning Evening, 30th - Social Evening, August 6 - On Air Evening, 13th - Junk Sale. **Steve Price G8VHL on (0405) 769130.**

Kent

Bromley & DARS. 3rd Tuesdays, 7.30pm. The Victory Social Club, Kechill Gardens, Hayes, Kent. July 20 - 144MHz DF Hunt. **Alan G7GBH on 081-777 0420**
Medway AR & TS. Fridays. Tunbury

Hall, Catkin Close, Tunbury Avenue, Walderslade, Chatham, Kent. Visitors & new members welcome. July 23 - DX Quiz. **Mrs Gloria Ackerley G70VI, 40 Linwood Avenue, Strood, Rochester, Kent ME2 3TR. Tel: (0634) 710023.**

Sevenoaks & DARS. July 19 - Radio Control Of Models by Mr. Weston. **The Secretary, c/o Sevenoaks District Council, Council Offices, Argyle Road, Sevenoaks, Kent TN13 1HG.**

South East Kent ARC. Wednesdays. Dover YMCA, Leyburne Road, Dover. July 14 - DF Preparations & Mods by G3ROD, 21st - Natter Night/Committee Meeting, 28th - Fox Hunt. **Mick Bowers G7NOR on (0304) 825030.**

Lancashire

Hesketh ARC. Every other Tuesday. Birkdale, Southport. July 20 - Temperature Measurement, August 3 - Electrostatics. **Bernie G7DEM on (0704) 63344.**

Leicestershire

Charnwood ARCC. 1st & 3rd Sundays. The Albion, Loughborough. July 11 - Club AM Day & BBQ, 18th - VHF Night On Air at Albion, August 1 - 20M Night On Air at Albion. **Phil on (0509) 232927.**

Lincolnshire

Grantham RC. 1st & 3rd Tuesdays, 8pm. Kontak Sports & Social Club, Barrowby Road, Grantham. July 20 - Training Guide Dogs by G3IWC, August 3 - The Secret War by Henry G4MHB. **John Kirton G8WWJ on (0476) 65743.**

Merseyside

Liverpool & DARS. Tuesdays, 8pm. Churchill Club, Church Road, Wavertree, Liverpool. July 13 - GX3AHD On The Air, 20th - L&DARS 80th Birthday, Old Timers' Night, 27th - Surplus Sale. **Ian Mant G4WWX on 051-722 1178.**

Wirral & DARC. Irby Cricket Club, Mill Hill Road, Irby, Wirral, 8pm. July 14 - Bells & Whistles for PMR by Andy G7HUD, 21st - D&W, The Lighthouse, Wallasey, 28th - Revenge DF Hunt, start 8pm Heswall Lay-by, August 4 - D&W, The Twelfth Man, Greasby. **Paul Robinson G0JZP on 051-648 5892.**

Norfolk

Dereham ARC. 2nd Thursdays, 8pm. St. Johns Ambulance Hall, Yaxham Road, Dereham. July 8 - Night On The Air at Joe's G7MPO, August 12 - BBQ & Informal. **Mark Taylor G0LGI on (0362) 691099.**

Nottinghamshire

Mansfield ARS. 2nd Mondays, 7.30pm. Polish Catholic Club, off Windmill Lane, Woodhouse Road,

Mansfield. July 12 - Talk by Weatherman John Bound. **Mary GONZA on (0623) 755288.**

Nottingham ARC. Thursdays, 7.30pm. Sherwood Community Centre, Mansfield Road, Nottingham. July 8 - Forum, 15th - Foxhunt No 4/Activity, 22nd - Junk Sale, 29th Construction/Activity, August 5 - Visit from Castle Electronics. **Ian Miller G4JAE on (0602) 232604.**

South Notts ARC. Highbank Community Centre, Farnborough Road, Clifton Estate, Nottingham, or Fairham Community College, Farnborough Road, Clifton Estate. July 9 - Talk-in on S22/SWR Facts and Fallacies by Ron Disney G0HNZ, 11th - Third Fox Hunt, 16th - On Air, HF & VHF, 23rd - Construction at Fairham College, 25th - 4th Fox Hunt, 30th - Talk-in on S22/Open Forum - Members Only, Planning for Club Field Day & BBQ, 31st - Club Field Day & BBQ - Day 1, August 1 - Club Field Day & BBQ - Day 2, 6th - Talk-in on S22/Mobile HF Aerials and Mobile Fast Scan TV by Barry G0LCU. **Julie Brown G0SOC, PO Box 4, Nottingham NG11 9DE.**

Oxfordshire

Prudential ARS is open to all employees & ex-employees of the Prudential companies. **David Dyer G4DNX at 'Highbank Cottage', Underhill, Moulsoford, Oxon OX10 9JH.**

Scotland

Banff & DARC. 1st & 3rd Fridays. Banff Castle, Castle Street, Banff, Aberdeenshire AB45 1DL. July 16 - Fox Hunt & Fun Night, 30th - Preparations For Castle Gala Day. **Martin Andrew GM6VXB on (03465) 82061.**

Somerset

Yeovil ARC. Thursdays. Red Cross HQ, Grove Avenue, Yeovil, Somerset. July 8 - Simple Milliwatt Phone Transmitters by G3MYM, 15th - 144MHz Direction Finding by G3ICD, 22nd - Further Ideas on The Yeovil Rig by G3PCJ, 29th - Natter Night and Committee Meeting, August 5 - Operating And Controlling Nets by G0NMM, 12th - Activities for Amateur Radio Clubs by G3MYM. **Cedric White G4JBL on (0258) 73845.**

South Glamorgan

Barry ARS. Thursdays. Sully Sports Pavilion, Burnham Avenue, Sully. **Ann MacKay GW0SQT, QTHR.**

South Yorkshire

Barnsley & DARC. Mondays 7.30pm. Radio club room & shack, at the rear of the Darton Hotel, Station Road, Darton, Barnsley. July 19 - Contests & Awards by John G4RCG, 22nd - Special Event Station at Darton High School, 26th - On The Air Night with GB4AXR, August 8 - Radio Astronomy by Malcolm G8RWN, 9th

- On The Air Night with GB4AXR. **J. P. Caledon-Scott G4LRS on (0226) 203448.**

Suffolk

Felixstowe & DARS. June 19 - Walton Hobby Faire, Demonstration Station, July 19 - Visit to Suffolk Ambulance HQ, Bramford, Ipswich, August 2 - Amateur Television In Suffolk by Sam Jewell G4DDK. **Paul Whiting G4YQC on (0394) 273507.**

Leiston ARC. 1st Tuesdays, 8pm. Sizewell Visitors Centre, Sizewell Power Station. August 3 - Construction Night. **Bob Simmons G0HSI on (0986) 874800.**

Sudbury & DARC. 1st Tuesdays, 8pm. Five Bells Inn, Great Cornard, Sudbury, Suffolk. August 3 - The Grid Dip Oscillator by Tony Harman G8LTY. **Colin Muddimer G0PAO on (0787) 77004.**

Surrey

Coulsdon ATS. 2nd Mondays, 7.45pm. St. Swithun's Church Hall, Grovelands Road, Purley, Surrey. July 12 - Inter Club Team Quiz Night, all local clubs invited to join in teams of four. **Andy Briers G0KZT on (0737) 557198.**

Guildford & DRS. 2nd & 4th Fridays. Guildford Model Engineers HQ, Stoke Park, Guildford, Surrey, 8pm. Visitors always welcome. **M. W. Marshall G0RXX on (0932) 344351.**

Surrey RCC. 'Terra Nova' The Waldrons, Waddon, Croyden, Surrey. July 19 - Natter Night. **Berni G8TB on 081-660 7517.**

Sutton & Cheam RS. 3rd Thursdays, 7.30pm. Sutton United Football Club, The Borough Sports Ground, Gander Green Lane, Sutton, Surrey. Natter Nights - 1st Thursdays. July 17 - BBQ at G30LX, 'PalFREYS', Picquets Way, Banstead, 24th - 144MHz Low Power Contest, 25th - 432 MHz Low Power Contest. **John Puttock G0BWW, 53 Alexandra Avenue, Sutton SM1 2PA.**

The Kingston & DARS. 3rd Wednesdays, 8pm. Alfriston, 3 Berrylands Road, Surrey KT5 8RB. July 21 - DXCC by Roger Burton G3ZLQP. **Ray Fuller on 081-398 1128.**

Wimbledon & DARS. 2nd & last Fridays. St. Andrews Church Hall, Herbert Road, Wimbledon SW19. July 9 - Book Fair, 30th - Annual Camp Briefing. **Chris Frost G0KEB on 081-397 0427.**

Warwickshire

Mid-Warwickshire ARS. 2nd & 4th Tuesdays. July 13 - PMR Presentation by Castle Electronics, 27th - Fox Hunt, 7pm start. Horizontal FM on 143.350. **Don Darkes G8HRI on (0926) 424465.**

Stratford-Upon-Avon & DRS. 2nd & 4th Mondays, 7.30pm. Home Guard Club, Main Road, Tiddington,

Stratford-Upon-Avon, Warwickshire. July 26 - Construction Contest. **Alan Beasley G0CXJ on (0608) 82495.**

West Midlands

Midland ARS. Unit 22, 60 Regent Place, off Caroline Street, Birmingham B1 3NJ. Wednesdays - RAE classes. Thursdays - Natter Nights. 2nd & 4th Mondays - PC Night. Last Fridays - Atari Night. **John Crane G0LAI on 021-628 7632 evenings.**

West Bromwich Central RC. Sundays, 7.30pm. The Sandwell Public House, High Street, West Bromwich. **Ian Leitch G0PAI on 021-561 2884.**

West Sussex

Crawley ARC. Wednesdays, 8pm & Sundays 10.30am. Hut 18, Tilgate Forest Recreational Centre, Tilgate, Crawley, Sussex. July 9 - UFO Lecture by Arthur Tomlinson. **P. Cheyney G0PVK, 11 Southgate Drive, Southgate, Crawley, Sussex RH106EE.**

West Yorkshire

Denby Dale & DARS. Pie Hall, Denby Dale, nr. Huddersfield, 8pm. **Ivan Lee, Clayton Lodge, Sunnyside, Edgerton, Huddersfield HD3 3AD.**

Halifax & DARS. 1st & 3rd Tuesdays, 7.30pm. August 17 - Old And New Equipment by Jim G4MH. **David Moss G0DLM on (0422) 202306.**

Keighley ARS. The Ingrow Cricket Club, Ingrow, Keighley, 8pm. July 15 Night On The Air by GX7KRC, 22nd - Natter Night, 29th - Alignment Evening G3TQA, August 5 - Natter Night, 12th - Naylor Bros Car Restoration Visit. **Kathy Conlon G0RLO on (0274) 496222.**

Wakefield & DRS. Tuesdays, 8pm. First Floor Rooms, Ossett Community Centre, Prospect Road, Ossett. July 13 - VLF/Cave Radio, 20th - Construction Evening, 27th - Treasure Hunt. G4BLT Rick Sterry. **Roy Harvey (G0TBY), 12 Hillcrest, Altofts. Normanton. Yorks WF6 2NT.**

Wiltshire

Trowbridge & DARC. 1st & 3rd Wednesdays, 8pm. Southwick Village Hall, 8pm. July 21 - Natter Night, August 4 - Family Picnic. **Ian G0GRI on (0225) 864698.**

Donna says "send in some funny club photos or anecdotes to liven up this page... really good ones will end up in print and make your club famous!"

NEVADA

EVER

SCANNING RECEIVERS



NEW - MVT-7100, Set to be THE handheld of 1993. This radio must be heard to be believed. It provides effortless reception of SSB and CW signals using TRUE carrier injection with 50Hz resolution. It can even (with accessories) be hooked up for FAX and DATA reception.

- 100kHz-1650MHz
- 1000 memory channels
- All mode reception (incl. SSB & CW)

Each set is supplied with all accessories including: UK Charger, NiCad Batteries, Earphone, Telescopic Antenna, Original Yupiteru English Manual..... **PRICE £449**



YUPIUTERU MVT 7000 HANDHELD

- Receives 8 to 1300 MHz 100kHz-1300MHz (at reduced sensitivity)
- 200 Memory channels
- Rotary or keypad freq. control
- AM/FM/WFM
- Large display with strength meter

Each set is supplied complete with:- Full set of high power NiCads, AC charger, DC power lead and carry strap **£369**

HP2000 HANDHELD

Still our most popular handheld scanner.

- 500kHz-1300MHz
- 1000 Memory channels
- AM/FM/WFM Modes
- Sensitive Receiver
- Supplied with all accessories & UK charger..... **£299**



MS1000 Base/mobile

A mobile version of the HP2000 handheld but with added features.

- ★ Tape recorder voice activated switching
- ★ Audio squelch
- ★ 500kHz-600MHz, 805-1300MHz
- ★ Supplied with mains adaptor..... **£279**



MVT-8000

Mobile version of the 7000 c/w mains adaptor. Especially sensitive @ UHF. Recommended..... **£389.00**

AR3000A

Our most popular base scanner. Latest updated version. (100kHz-2036MHz) **£899**



SCS computer software

New software for IBM/clones. Gives logging, monitoring and control of AR3000..... **£59.95**

ACE PAC-3 software

Full feature software for AR3000..... **£119**

AR1500 HANDHELD

Covers 500kHz-1300MHz receiving NFM/WFM/AM and SSB. Supplied with a large selection of accessories including:-

- Charger
- Dry Cell Battery Case
- Long Wire Antenna
- Ear Piece
- Soft Case..... **£339**



YAESU RADIO

Yaesu FRG100 HF receiver

A superb new radio covering 50kHz to 30MHz - our top selling general coverage receiver..... **£559**



Yaesu Radio

FT747GX Economy HF Transceiver.....	£822.00
FT890 100w Gen. Coverage HF.....	£1295.00
FT530 Latest Twin Band Handheld.....	£495.00
FT1000 200w Top/Line in HF.....	£3475.00
FT990 All Mode Gen. Coverage HF.....	£2250.00
FT757GX2 Good reliable HF.....	£1089.00
FT767GX HF + VHF/UHF modules.....	£1660.00
FT650 Tri-Bander HF 6/10/12m.....	£1200.00
FRG8800 Digital S/Wave Receiver.....	£610.00
FRG9600m 60-950MHz Scan rec.....	£585.00
FT290R2 2m M/Mode Portable.....	£516.00
FT690R2 6m M/Mode Portable.....	£505.00
FT790R2 70cm M/Mode Portable.....	£610.00
FT5200 2m/70cm Dual band mobile.....	£657.00
FT26 2m FM Handheld.....	£272.00
FT76 70cm FM Handheld.....	£295.00

Yaesu Accessories

G-400 Bell type Rotator.....	£187.00
G-600RC Extra H/Duty Rotator.....	£309.00
GS-050 L/weight Bearing for above.....	£26.95
8-Core Rotator Control Cable (per m).....	£0.96
FP-757HD H/Duty PSU for Yaesu HF.....	£310.00
FRV-8800 VHF Converter 118-175MHz.....	£112.00
FRT-7700 ATU for S/Wave Receivers.....	£74.95
YH-55 Padded Comms. H/Phones.....	£25.95

DRAKE



Drake R8E - To own one of these receivers is a dream in itself - everything you could ever want in facilities and performance is in the R8E. Drake are no newcomers to radio - they have been No.1 in the USA since 1943! Unlike other expensive receivers as standard, therefore, there are no hidden extra costs. Its performance is truly staggering! With an excellent dynamic range coupled with superb filtering it takes a lot of beating! Multiple scan facilities, easy use 100ch. memory, all mode coverage and synchronous detector for improved AM reception are just a few of its extensive range of facilities.

- ★ Twin VFO's
- ★ Selectable AGC
- ★ Passband Tuning
- ★ Timer Function
- ★ RS232 Interface
- ★ Built-in Pre-Amp
- ★ Dual Noise Blanker
- ★ Non-Volatile Memory
- ★ 100kHz - 30MHz Wide Coverage

Options

Matching Speaker.....	£49.95
PC Drive Software.....	£59.95
Full W/Slop Manual.....	£29.95
VHF Converter (Internal).....	£225.00

£995

KENWOOD RADIO

Kenwood TS50



Just arrived. This new "micro" 100 watt HF mobile rig is in short supply because of its popularity. We have purchased large quantities - call for info or part exchange price on your old HF rig..... **£999**

Kenwood Radio

RS000 S/Wave Rec. 150kHz - 30MHz.....	£939.00
TS-950SDX HF Trans auto ATU & DSP.....	£3475.00
TS-450SAT Mobile HF with auto ATU.....	£1400.00
TS-690S Mobile HF & 6m.....	£1400.00
TS-140S Budget HF Transceiver.....	£845.00
TM-732E 2m/70cm Twin Mobile.....	£629.00
TR-751E THE BEST 2m M/Mode.....	£705.00
TH-78E Twin Band Handheld.....	£440.00
TS-790E Tri-Band Base 2/70/Op. 23cm.....	£1690.00

Kenwood Accessories

PS-52/53 Mains PSU Full Duty.....	£269.00
TL-922 HF 2kW amp.....	£1645.00
MA-5 5Band Mobile HF Ant.....	£119.00
AF-50 Matching Auto ATU for TS50s.....	£279.00
SM-230 Station Spectrum Display.....	£795.00
HS-5 Deluxe Comms H/Phones.....	£45.00

Kenwood Microphones

MC-50 Desk Mic.....	£84.95
MC-60A Desk Mic (PreAmped).....	£99.95
MC-80 Electret Desk Mic.....	£59.95
MC-85 Deluxe Desk Mic.....	£119.00
MC-43S Dynamic H/Mic.....	£22.95
MC-44E H/Mic Prog. Func.....	£29.95
MC-45E H/Mic Multi Functions.....	£29.95
MC-44DVE H/Mic DTMF.....	£45.95
MC-45DVE H/Mic DTMF.....	£49.95

ADONIS MICROPHONES

Adonis 508G

Built-in Compressor..... **£99.95**

Adonis 308G Built-in Mic Amp.....

£84.95



EXCLUSIVE NEW VIDEOS ON AMATEUR RADIO

Three-times Emmy award winning producer, Richard Masesen NW2L, has pulled out all the stops to create the most exciting and entertaining video series ever about Amateur Radio. Now available in the UK on PAL VHS format, these videos are a must for the newcomer or experienced operator.

GETTING STARTED IN HAM RADIO

Takes the viewer through setting up the first station, including the antenna. Show how to select equipment, how to use repeaters, the importance of grounding and soldering, and how to get the best from your station.....

£19.95 + £2.75 p&p

GETTING STARTED IN PACKET RADIO

Shows how to get started in using your computer on the radio. Includes step by step help on making packet contacts and using bulletin boards, networks and satellites.....

£19.95 + £2.27 p&p

GETTING STARTED IN AMATEUR SATELLITES

Shows how veteran operators set up their satellite stations and how to track the satellites with ease. How to access current satellites and work DX through them. This video is filled with easy to understand advice and tips that cannot be found elsewhere.....

£19.95 + £2.75 p&p

GETTING STARTED IN DXING

Top DX'ers share their experience on equipment, antennas, operating skills and QSL'ing. See them working rare DX and learn the techniques that may well give you the competitive edge!.....

£19.95 + £2.75 p&p

EXTENDAMAST 10 METRE RETRACTABLE MAST



Suitable for: Dipoles, long Wires, VHF/UHF Beams, G5RV and many other antennas. A new and inexpensive aluminium 10 metre retractable mast that may be used at home or for portable use. Easy to erect in minutes - your antennas can now be independent of trees, buildings and other make shift fixing points! The steel guying rings are corrosion protected to provide years of useful life. Because individual requirements vary guy wires are not included. A base fixing plate is available as an extra.

Introductory Price £69 Plus £8 Carriage

THIS MONTH'S BEST BUY

NRD-525 HF GENERAL COVERAGE RECEIVER

Considered to be one of the finest receivers ever made! We've managed to locate a limited quantity at a very special price. Now's your chance to own one of the thoroughbreds amongst receivers.

- ★ Receives 90kHz to 34 MHz
- ★ 200 channels of memory
- ★ RTTY, CW, SSB, AM, FM, FAX
- ★ Pass band tuning
- ★ Wide dynamic range
- ★ Built in Clock/Timer circuits
- ★ Fully solid state modular design
- ★ Programmable memory scan
- ★ Microprocessor controlled, electronic tuning

LIMITED QUANTITY AT £795



THE FASTEST MAIL ORDER COMPANY



USE YOUR CREDIT CARDS FOR SAME DAY DESPATCH

EVERYTHING FOR THE RADIO ENTHUSIAST

HUGE STOCKS - FAST DELIVERY - PERSONAL SERVICE

RING OUR HOTLINE NOW FOR FURTHER DETAILS
HOTLINE: (0705) 662145 FAX ORDER ON: (0705) 690626

ICOM RADIO

ICOM IC-737 - A new full coverage HF transceiver with Auto ATU, Electronic Keyer, good receiver and a host of extras... **£1425.00**



- IC-735 HF all band mobile £1135.00
- IC-728 HF 100w Mobile £945.00
- IC-729 HF Plus 6m Mobile £1230.00
- IC-229E 2m FM Mobile £369.00
- IC-P2ET 2m FM Handie £303.00
- IC-P4ET 70cm FM Handie £360.00
- IC-V21E 2m/70cm Handie £425.00
- IC-100 Mobile Receiver £595.00
- IC-7100 Wide Band Base RX £1375.00
- IC-R72E HF S/Wave Receiver £815.00
- IC-R1 Handheld Receiver £395.00

ICOM ACCESSORIES

- IC-AT150 Auto ATU £403.00
- IC-PS55 Deuxe 20A PSU £232.00
- SP-21 Base Station Speaker £132.00

POWER SUPPLIES

- Standard 3 Amp UK Spec £17.95
- Standard 7 Amp UK Spec £29.95
- Standard 10 Amp UK Spec £59.95
- HP125 12 Amp Twin Meters £79.95
- HP120S 30 Amp Twin Meters £139.00
- HP120S 50 Amp Twin Meters £220.00

0% FINANCE AVAILABLE ON SELECTED ITEMS (SUBJECT TO STATUS)

USE YOUR OLD GEAR FOR A DEPOSIT

ANTENNAS

SAGANT End Fed ZEPP Antennas
 Using Vinyl coated annealed copper wire - supplied with matching unit for coax feed - high quality Japanese made.

- 3.5 MHz (39 mtrs long) £79.95
- 7.0 MHz (20 mtrs long) £79.95
- 14.0 MHz (9.9 mtrs long) £79.95
- Trap Dipole 40/80 £89.95
- Pair 40 mtr Traps £19.95
- 2 kW Balun 1:1 £29.95

TONNA VHF BEAMS

- 2m 9 Ele. Portable Beam (13.1 dB) £49.95
- 2m 9 Ele. Crossed Beam (13.1 dB) £86.95
- 2m 11 Ele. Beam (14.1 dB) £77.95
- 70cms 9 Ele. Beam (13 dB) £43.95
- 70cms 19 Ele. X Beam (16.2 dB) £61.95
- 2m/70cms Oscar Special (9/19 Ele) £85.95

DIAMOND BASE

- X50 2m/70cm base vert £79.95
- X300 2m/70cm higher gain vert £129.95

SCANNING ANTENNAS

SCANMASTER 1300 DISCONE
 Stainless steel top of the range "N" connector. Receives (25-1300MHz), transmits 6m, 2m, 70cm, 32cm and 23cm bands. **£49.95**

SCANMASTER BASE

New high quality wideband 500KHz - 1500MHz receiving antenna fibreglass/stainless steel "N" type connector. **£39.95**

SCANMASTER MOBILE

High quality magnetic mount covers 25 - 1000MHz supplied c/w low loss coax and fitted BNC connector. **£29.95**

SKYBAND

Wideband discone 25-1300MHz. **£27.95**



EARTALKER

EarTalker - A completely new concept in microphone technology. The EarTalker is a combination of earphone and microphone which is worn within the ear. It provides outstanding transmitted audio quality and is suitable for all leading brands of handheld (Call for details on your particular model), Separate volume, PTT switch and control box **£29.95**

MICRO-READER



ERA Microreader - Data Communications decoder - decodes RTTY, CW, AMTOR (A) & SITOP (B). 16 character LCD display needing only connection to receiver extension speaker socket. Shortly to become available will be the large 4-line LCD display with built-in parallel printer driver part. Variable in-built Morse tutor. (Call and reserve your optional display now) **£169.00**

ALINCO & STANDARD

Alinco DJ-580 - Fast becoming the top selling Twin Band handheld here in the U.K. Complete with all "mod-cons" including AM Airband RX. Comes ready to go just plug-in and charge - the perfect way to operate 2M & 70 Cms **£449**

Alinco DJ-F1E - Don't take my word for it but my customers agree that this is the perfect companion when considering a 2M handheld. Full coverage and again offered with Airband receive **£265**

Alinco DR-599E - Replacing the 590E - This little unit has an impressive 50W on each band, automatic remote repeater function (ideal roynet exercises) and a host of extra facilities including ext. RX. Full colour brochure available - call us now! **£690.00 incl. free duplexer**

Standard C528 - This Twinband handheld is the model the others were based on! Still a popular choice with many features including remote cloning and repeater talk-thru! **£420**

Alinco DJ-F4E - A popular novice band radio on 70cms. Simple to operate handheld with 40 memories and 5 Wats output. **£280**

LOW LOSS CABLE

Superb Japanese low loss cable with aluminium foil and braid double earth screening, tough weather resistant yet flexible. Fantastic low loss - suitable for high power and frequencies up to 3GHz.

- 5D-FB (8.1mm - 0.055dB/mtr) **£0.75/mtr**
- 8D-FB (11.1mm - 0.039dB/mtr) **£1.79/mtr**
- 10D-FB (13.1mm - 0.031dB/mtr) **£2.75/mtr**

Losses quoted at 100MHz



CONNECTORS (for above)

- "N" Types **£3.56**
- BNC **£3.75**
- PL259 **£1.50**

NEW RANGE OF NEVADAHIGH POWER ATU COMPONENTS

- CAPACITORS 2KW (8KV) 250pF **£19.95**
- 250 + 250pF Split **£24.95**
- 200 + 200pF Diff **£24.95**
- CAPACITORS 4KW (12KV) 250pF **£24.95**
- 250 + 250pF **£29.95**
- ROLLER COASTER INDUCTOR 28uH 3kV **£29.95**
- HIGH POWER BALLUNS UNPOTTED FOR ATUs
- 2kV 1:1 **£19.95**
- 2kV 4:1 **£19.95**
- 4kV 1:1 **£24.95**
- 4kV 4:1 **£24.95**

KENPRO RADIO

KT-44 - 70 cms handheld. Thumb wheel frequency control. Full 10MHz! Ideal novice or repeater user. c/w NiCad, beltclip & charger **£159.00**

KT-22 - Popular 2M version of the KT-44 with simple NO FUSS operation. Ideal standby handheld or for use on Pocket **£149.00**

NEW HAND-HELDS

ALAN CT-145 - Fully featured 2M handheld with options for DTMF & CTCSS Paging. 5 watts output is available when powered from external 12V DC supply. Now with extended receive - 130-169MHz. Excellent reliability & performance. **£199.00**

ALAN CT-450 Fully featured 70cms H/held with facilities and options similar to the CT145 **£225.00**

SONY SHORTWAVE

As a Sony Shortwave centre, we stock a complete range of Sony Shortwave product. Here is a selection of our best sellers:

SW77 - One of the best new editions to the Sony range. The SW77 covers 150kHz-30MHz plus an additional 76-108MHz. With a rotary tuning dial, 125 scan memories, the reception of AM/FM/USB/LSB and CW modes is a breeze. Fitted tape record facility finishes this superb all round receiver. **£399.00**

SW1E - Pocket Shortwave plus VHF Commercial radio. Each unit is supplied with headphones, case and shortwave guide. This model will not hurt your pocket. **£165.00 this month only**

SW55 - A new portable that gives good reception of SSB and all modes from 150kHz to 30MHz and 76-108MHz VHF. **£279.00**

SWR/POWER METERS

- Diamond SX100** (1.6-60MHz) 3kW **£124.95**
- Diamond SX200** (1.8-200MHz) 200W **£89.95**
- Diamond SX400** (140-525MHz) 200W **£104.95**
- Revox W520** (1.8-200MHz) 200W **£84.95**
- Zetagi Mod 700** Professional line using 2 separate sensors 2-3MHz, 120-500MHz, cross needle power/SWR up to 1kW **£99.95**

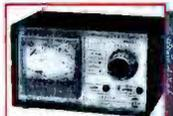

OUR NEW SPRING EDITION CATALOGUE IS OUT NOW
 PACKED FULL OF INFO AND NEW PRODUCTS
ONLY £2
 (Includes discount voucher)

NEW VECTRONICS AMP

Vector 500. "Canadian Punch!" A full 1000 Wats PEP on SSB enables you to beat the pile-ups. Now available here in the U.K. Top band to 10 from only 60-80 Wats input. Call now for your brochure!



- 4x8 11A Low Cost Tubes
- 600W C.W. 1000W PEP
- Compact 24lb weight

£865

TRADING POST

We buy as well as sell new and used radio equipment, please feel free to call Paul or John on our Hotline for an instant quote on either P/X or Buy-Ins.

- Yaesu FT-690 6m Porta-pack **£345**
- Yaesu FRG-9600 25-950MHz RX **£365**
- Yaesu FT290R 2m Porta-pack **£325**
- Icom R72 Short wave RX, boxed **£695**
- Tokyo HC200 ATU (80-10m) **£99**
- Trio R1000 Short wave digital RX **£325**
- Yaesu FT-902DM HF TX, v.g.c. **£625**
- Adonis 308 Desk mic (boxed) **£65**
- Icom R100 Mobile scanning RX **£425**
- Tokyo HT-120 20m mobile TX/RX **£245**
- CT1600 2m H/H c/w BS25 & H/Set **£165**
- Alinco DJ-560 Twin bond h/held **£345**
- Kenwood TS-530/S HF TX, v.g.c. **£549**
- Adonis 508 Desk Mic (compressor) **£75**
- Yaesu FRT-7700 S/W RX ATU **£49**
- Icom IC-R71E S/W/ Receiver, v.g.c. **£675**
- Yaesu FL2000B HF 1kW PEP Amp **£495**
- Yaesu FT102 HF Transceiver **£625**
- Sommerkamp FT1012D HF TX/RX **£495**
- Yaesu Memoriser 2m FM mobile **£185**
- Trio 130V c/w VFO120 (all filtered) **£450**
- Alinco DR590 c/w REM & Duplexer **£450**
- Yaesu FT757 GX Auto ATU & H/D PSU **£1045**
- Icom 725 Mobile HF TX, vgc **£625**
- Yaesu FRG7 Gen.Cov. S/W RX **£185**
- Yaesu FT726 2m/70cm/bm Modules **£975**
- Kenwood TS830S HF TX, vgc **£585**
- Tokyo HL110V 2m 100W Amp **£165**
- Yaesu FT757GX 12V Mobile TX **£599**

Call us now - even if we haven't listed your radio, for what we know to be unbeatable P/X deals.

VECTRONICS

Vectronics - Canadian based - HIGH QUALITY PRODUCTS

ANTENNA TUNING UNITS

- VC300** - 150 Watt (300W P.E.P.) ATU with dual pointer metering of FWD/REV/SWR. Two coaxial inputs plus wire or balanced line (4:1 balun included) **£149.00**
- VC3000LP** - As above but with built-in Dummy Load and peak or average pwr mtr **£169.00**
- HFT1500** - 1500 Watt ATU (3kW P.E.P.) coax, line wire, and balanced line inputs (4:1 balun included). Peak and average power reading meter. High quality roller coaster and slow motion variable capacitor drives allow you to match just about anything! **£399**
- PM-30** - Power/swr meter reads peak/average power up to 3kW 1.8-60MHz **£89**

T.V.I. SUPPRESSION

- KENWOOD LF30A** - 1.5kW low pass filter provides more than 60 dB suppression above 35MHz **£39.00**
- GLOBAL HP-4A** - UHF TV high pass/band break filter **£9.95**

SHOWROOMS:- 1A MUNSTER ROAD, NORTH END, PORTSMOUTH PO2 9BS

MAIL ORDER:- 189 LONDON ROAD, NORTH END, PORTSMOUTH PO2 9AE

Richard Newton
GORSN tests one of
the smallest
hand-helds, the
Icom IC-2iE.

The ICOM IC-2iE 144MHz Hand-Held



The Icom IC-2iE is a small v.h.f. hand-held transceiver, covering 144-146MHz inclusive. It is supplied with a 7.2V/400mAh rechargeable battery pack, a battery charger, a helical antenna, carry strap, belt clip, instruction manual and circuit diagrams.

The radio is finished in grey plastics, and is quite simple in appearance. There is a BNC connector on the top of the radio, next a dual rotary control for the volume and squelch. There is also a rotary switch for changing frequency, that has secondary uses when setting up certain functions.

On the front of the radio is a large window for the black on grey liquid crystal display, this can be back lit by a very efficient green light.

The frequency read-out, and those of other major functions, are clear and easy to see. However, some of the other indicators are quite tiny and operators who have impaired eyesight may find difficulty in reading these. A clock is also included on the display.

Also on the front panel is the S button, this has many functions, but it's primary use is to control the scan facilities. There is a **monitor** or **squelch** defeat button, the **VFO/Memory** control button and the button that controls the light.

The main **Power** button is also situated on the front panel, it is considerably proud of the body of

the radio. I found that on several occasions when I was carrying the IC-2iE in my pocket or a holdall that it would turn itself on.

The **Function** and **PTT** controls are found on the left-hand side panel as you look at the radio. The right-hand side panel sports the external power supply socket and the sockets for the speaker/mic extensions.

All controls are well labelled and easy to use. However, the aesthetic design of the radio, which seems to be put forward as one of the selling features, does not favour left-handed people at all, I am sorry to say.

The slightly rounded shape of the radio's case lends itself wonderfully to right-handed operation, thus rendering left-handed operation clumsy and frustrating. This is not 'sour grapes' as I am right-handed myself.

The radio is not only small but very light. Using the well-recognised Salter Staffordshire kitchen scales I am able to say that the IC-2iE with supplied battery pack, helical antenna, carry strap and belt clip weighs approximately 255g!

It was the battery pack that surprised me most. It is very light and compact, fitting into the bottom of the radio as a cartridge. It is released by a small catch on the rear of the radio.

Impressions

My impression is that the radio is almost too small. I accept that it depends on the size of one's hand, but the radio seemed to get lost in mine.

Having said this, of course, this radio will fit in almost any pocket or handbag. But be careful, it is so light you may forget it is there and I don't suppose a 'number 5' wash is going to be of much benefit!

Before I go onto how this little radio works, I will briefly mention something that niggled me.

Most manufacturers reserve listing the selling points of their equipment to adverts, posters and leaflets, however on this occasion Icom have printed these details on the front of the IC-2iE, not on a piece of removable plastic, but indelibly on the front panel in white print.

I found this tacky to say the least. This would motivate me to purchase a carry case at my earliest convenience. Perhaps there is method in the madness after all.

The instruction manual was well set out and easy to understand.

The Icom IC-2iE can be used in two very different ways, in an **Easy** mode and a **Multi-Function** mode. The **Multi-Function** mode in turn has three different settings, but more about that later.

The radio is supplied in **Easy** mode. In this mode it offers ten memories and very few functions. You can scan the memories, the entire bandwidth or a programmed bandwidth of your choice.

In the **Easy** mode functions such as the back light and scan pause are pre-set and therefore can not be changed. It also has no duplex or offset facility at all. To set repeater offsets you have to

Review

momentarily go into **Multi-Function** mode and save the relevant repeater frequency with offset in a memory. I found this rather tedious.

Second Manual

If you purchase a IC-2iE you should be supplied with a second manual free of charge, entitled *Tech-talk*. I would suggest you ask for *Tech-talk* if you are not offered it as it is this manual that really shows what this little radio can do.

Tech-talk comes in the form of two, A2 sheets of paper printed on both sides. It is relatively easy to understand and gives good step-by-step instructions.

When in **Multi-Function** mode you can choose from three sub-modes. **All** gives you access to all the functions, **Sel** allows you to select which functions you want and **Auto** means that the radio will give you access to functions as and when it thinks you are ready! I jest not, it is true.

When you have chosen which **Multi-Function** mode is for you, you can start exploring the radio as now you have many more facilities to play with. I would suggest that you select the **All** mode.

These are some of the functions you can enjoy in the **Multi-Function** mode. 100 memories, split frequency operation with variable off-set, d.t.m.f. tone, paging, CTCSS squelch control and a power on/power off timer.

The operator can now set the parameters of certain facilities and functions. For example the l.c.d. contrast can be adjusted. The back light can be set to stay on when activated or turn off after a five second delay. The scan facilities can be set to stop and remain on a busy frequency or merely pause for five or ten seconds. CTCSS is also available as an optional extra.

Be warned, when you return to the **Easy** mode, all parameters are reset to their default values. Memories 10 to 99 can not be accessed, although the information in them will be retained and will still be there when you return to the **Multi-Function** mode.

Memories will hold all the usual information, frequency, off-set and the like. I found setting the memories very easy indeed.

In all modes, the radio keeps you up-to-date with what it and you are doing by short messages that appear in the liquid crystal display. This and the easy to understand manuals make the IC-2iE a joy to use. Perhaps the best way to use this radio is to spend a few days using it in the **Easy** mode, and then, when you have found your feet go to the **Multi-Function** mode and stick with that.

Being able to set the radio up to your own specifications appealed to me, I did find the IC-2iE to be a very versatile and user-friendly radio.

On transmit the radio has a variable output in f.m. mode. With the supplied battery pack the range is 20mW, 500mW or 1W. Using a 13.8V supply this changes slightly to 20mW, 500mW, 2.5W or 5W.

I could not fault this little radio, the 1W of r.f. and the helical antenna gave me great service, accessing the local repeater from various locations with only 500mW. The tone burst is activated by depressing the p.t.t. twice in rapid succession.

I received excellent reports on the transmitted audio and could find no fault with the audio quality on receive. The sensitivity on receive was superb.

In conclusion the Icom IC-2iE is a versatile, easy to use radio. It is not quite big or heavy enough for my liking, but this is a matter of style and has no bearing on how well the radio works.

In fact, the radio performs very well indeed, and proved to be a very capable and enjoyable companion. If the u.h.f. version, the IC-4iE is as good as its v.h.f. sibling I would say it could be an

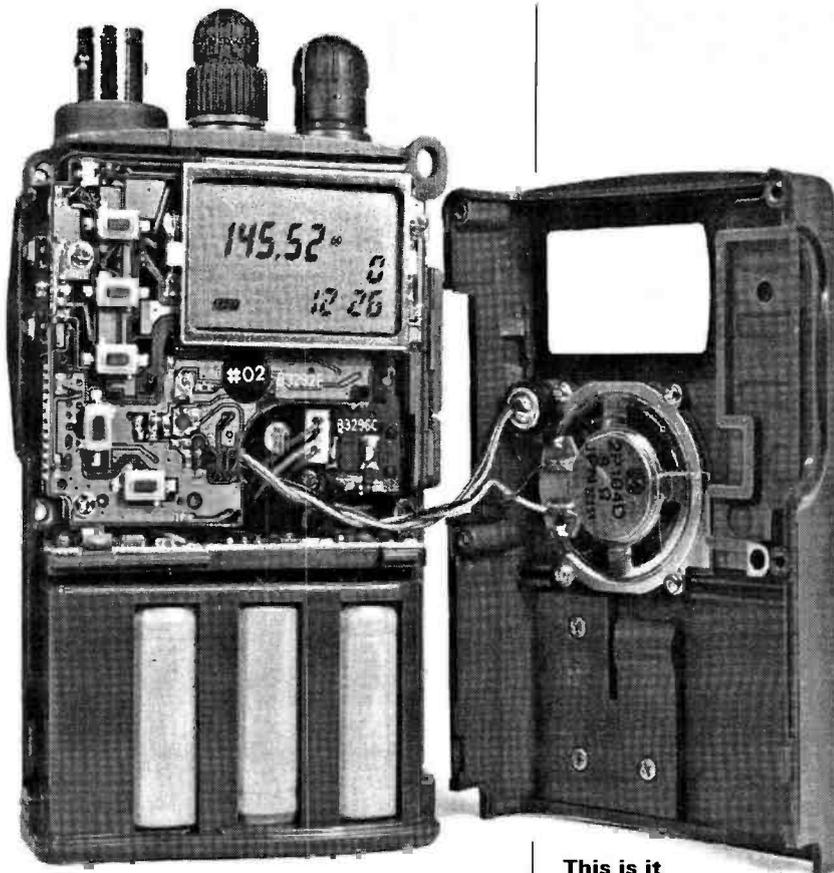

**This is it
at fullsize, tiny
isn't it?**

ideal radio for the novice licensee.

My thanks go to Icom (UK) Ltd., Sea Street, Herne Bay, Kent CT6 8LD. Tel: (0227) 741741 for the loan of the review model, which is available from them for £295 inc. VAT. PW

Specifications

General

Frequency Coverage	144-146MHz
Memory Channels	10 plus 2 scan edge channels
Default Tuning Step	25kHz
Usable Temperature Range	-10°C to +60°C
External DC Power Supply	6 to 16V d.c.
Current Drain at 13.8V	TX 1.4A/100mA RX 150/16mA
Frequency Stability	±10p.p.m.
Dimensions	58(w) x 91(h) x 30(d)mm
Weight	260g

Transmitter

Output Power at 13.8V	5W/2.5W/ 500mW/20mW
Modulation System	Variable reactance frequency modulation
Spurious Emissions	<-60dB/<-40dB
Maximum Frequency	
Deviation	±5kHz
Microphone Impedance	2kΩ±

Receiver

Receive System	Double-conversion superhet
Intermediate Frequencies	30.85MHz & 455kHz
Sensitivity	<0.18µV for 12dB SINAD
Selectivity	>15kHz/-6dB, <30kHz/-6dB
Spurious Response	
Rejection Ratio	>60dB
Audio Output Power at 13.8V	>200mW at 10% t.h.d.
Audio Output Impedance	8Ω

Bill Mooney G3VZU continues with the construction and testing of this double sideband, suppressed carrier transmitter.

The Bourbon QRP Transmitter Part 2

The circuit used in the PW Bourbon represents a useful application of the NE602 i.c., but just as interesting in this case is the method of construction.

The circuit was designed from the outset with surface mount implementation in mind and all prototyping was done with s.m.d. techniques. The p.c.b. track pattern for the Bourbon transmitter is shown in Fig. 2 and you will immediately notice how simple it is, even for such a moderately complex circuit. The component positions are also given in Fig. 2.

The use of surface mount devices makes it possible for this circuit to be completed on a p.c.b. measuring 40 by 43mm, without any attempt to go for maximum component density, and using only one side of the board for components. Double-sided laminate is used, the unetched side acting as a ground plane for improved r.f. stability.

In this design, 1206 size chip capacitors and resistors are used. The 1206 devices are highly recommended for naked eye work and hand soldering. Users quickly get accustomed to working at these dimensions. The resistors are marked with a 3-digit code, where the first two digits represent the ohmic value and the last digit the multiplier of the number of zeros. For example 272 is 2700Ω or 2.7kΩ. It is just possible to read the code on the 1206

Fig.2: The full size track pattern, with the overlay at twice size. Component Rz is a 0Ω resistor or linking component.

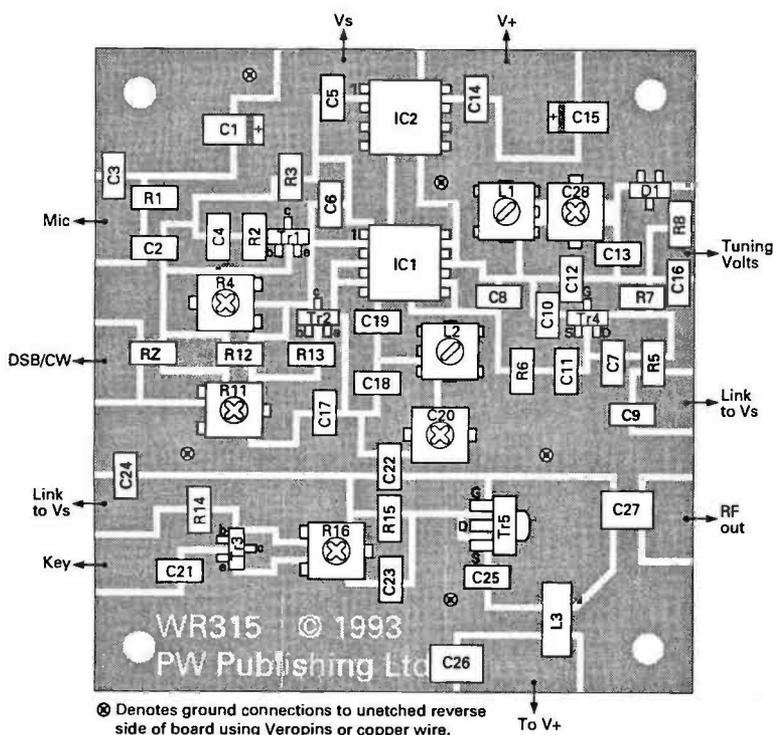
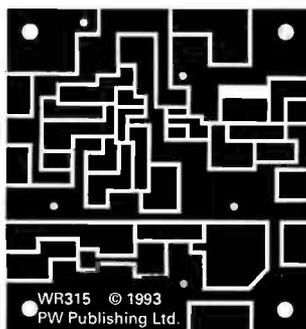

resistors in good light, but a magnifier makes it easier and eliminates errors. A hand magnifier is also a good investment for checking the quality of soldering.

The smaller 0805 chips are now becoming more popular, but are not recommended for the beginner.

The p.c.b. should be made from standard 1.5mm double-sided laminate, any favoured technique may be used. A simple method that will give adequate results is to make two photocopies of Fig. 2 on the type of acetate used for overhead projectors, turning the master through 90° for the second copy to cancel copier unevenness. Cut out the copies and sandwich them in register. This may now be used to produce a p.c.b. from ultra violet sensitive p.c.b. in the normal way.

The corner mounting bolt holes should be drilled before cleaning the p.c.b. prior to population. Similarly, drill the holes for connection to the ground plane at this stage using a 1mm drill. A coating of clear solder-through lacquer will maintain the beauty of the p.c.b. and another coating after construction will improve stability.

Alternatively, a ready-made p.c.b., WR315, is available from the PW PCB Service, Badger Boards, 87 Blackberry Lane, Four Oaks, Sutton Coldfield B74 4JF. Tel: 021-253 9326.

The use of an s.m.d. assembly jig is highly recommended for soldering surface mount devices. The jig will hold each chip in place so that it can be soldered correctly, which means applying the solder and iron to the joint at the same time. Without the jig it is difficult to produce a neat looking p.c.b. with all the chips neatly aligned, - the surface tension of the solder and the light weight of the components conspire against this.

Component Order

Use a fine, 26s.w.g., low melting point solder and a fine-tipped iron. When you come to populate the p.c.b. there are one or two tight spots. The inductor, L1, should be soldered in place before C28 and similarly L2 before C20. The Toko 5CD coils have five pins, two of which are active, but all should be soldered to ground except the hot end of the coil - Pin 1 or 3. Also solder the can to the ground plane at each side. Removing these coils is a bit tricky, but it's best done with a hot air blower or desoldering braid.

The tinned copper wire or Veropin connections to the rear ground plane should be left almost until last so that the p.c.b. remains flat in the jig. The position and number of these connections are not critical, but at least those shown should be placed. Both f.e.t.s should be soldered in place last of all.

The order of placing the other components is not important, but it may be found useful to solder the i.c.s in place and perhaps the tantalum capacitors at an early stage. These will act as reference points and make it easier to locate other component positions. Do use tantalum capacitors, they are smaller and are about twice as efficient as aluminium types for the same value. In most applications a 33µF tantalum capacitor can replace a 47 or 68µF aluminium one. Be careful to observe their correct polarity as reverse connection will destroy them! The output m.o.s.f.e.t. Tr5, goes on a small area of p.c.b. about 6.5mm square, which is its heatsink.

The simplest use of this device is as a straight transmitter with a mechanical change-over switch for receive/transmit. The wiring is shown in Fig. 3. A prototype was set up in this way and it fits comfortably into a diecast box. Phono sockets are excellent for the

connections and are widely used in such QRP projects.

The p.c.b. makes an ideal companion for an NE602-based receiver that fits on a similarly small p.c.b. In this case, the local oscillator output may be taken from Pin 7 of IC1 (TX or RX) for full transceiver operation. Some constructors may prefer a mechanical capacitor for the main frequency control thus making best use of the excellent temperature characteristics of the COG dielectric chip capacitors and the Toko 5CD coil.

In this case, the Varicap function could be demoted to that of an r.i.t. control by reducing the value of C13. In Fig. 3 the diode, D2, clamps the gate of the output device to the ground in the receiver position. Many other arrangements are possible as the Bourbon is intended mainly as a functional module to be incorporated in larger projects.

Getting It Going

It is always advisable at this stage to double check everything before applying power. To test the circuit you will need at least a calibrated receiver to set the v.f.o. on frequency and a multi-meter, preferably high impedance. The keyer, v.f.o. and p.a. need links to the appropriate supply lines, V+ or Vs. This is useful for isolating parts of the circuit during testing. The slider of R16 must be set towards the lower end of its track - at the top end the stabilised voltage supply is applied directly to the collector! With the key plugged in and 'up' apply power from a 12V current limited power supply. In this position, Tr5 gate will be clamped to zero volts and the device turned off. The current drain with Tr5 off should be 8-10mA.

First set the v.f.o. by using the receiver to listen to the output. The r.f. voltage at Pin 6 should be about 1V peak-to-peak. Frequency coverage is set by adjusting L1 and C28. A small length of wire connected to the receiver input and placed close to the oscillator will make the process easier. If you re using a frequency meter don't over-couple it as it may 'pull' the oscillator frequency. A frequency meter is best used on the output around Tr5.

Check the a.f. amplifier next. For this you will need to plug a microphone into SK1. The voltage on Tr1 collector should be about 2.5V. Set R4 to give 0.1V on the emitter of Tr1 to start with, it can be adjusted for correct gain or minimum distortion later. A 'scope on IC1 Pin 1 will show if clipping is taking place due to excessive microphone output - small electret microphone can give 1V peak-to-peak. At this stage it will be convenient to set L2 to resonance to check that the mixer is doing its stuff. Place the receiver pick-up wire near the gate of Tr5 and tune in the residual carrier. With S1 in the d.s.b. position (Tr2 off), adjust the coupling to get a signal of about S3 on the meter or audibly. Speaking into the microphone should produce the familiar d.s.b. signal if the mixer is working. Adjust L2 and C20 for maximum recovered d.s.b. When all is OK, this should peak up to S9 + 20 or more.

Now check the c.w. function. Adjust R11 until the voltage on the slider is about 1.5V. Switch S1 to the c.w. position (R12 connected to Vs) and adjust R11 to get the same c.w. level as the peak d.s.b. (It will be possible to drive the output a little harder in c.w. mode if needed.) In the c.w. mode, L2 may now be readjusted for maximum mid-band output. To check the output stage it is important to connect a 50Ω dummy load to SK4 - a 47Ω resistor will do fine for this. Switch S1 to d.s.b. mode with no audio input in order to set the bias current. With the key 'down' adjust R16 to get a total consumption of, say, 50mA putting it in low-power Class AB and an acceptability high gain part of its characteristic curve.

The key should switch this on and off nicely and it should be possible to 'talk' the current up to about 80mA with the microphone. Switching to c.w. generates about 100mA of drain current. It is perfectly in order to run with less bias to keep Tr5 dissipation down, especially when

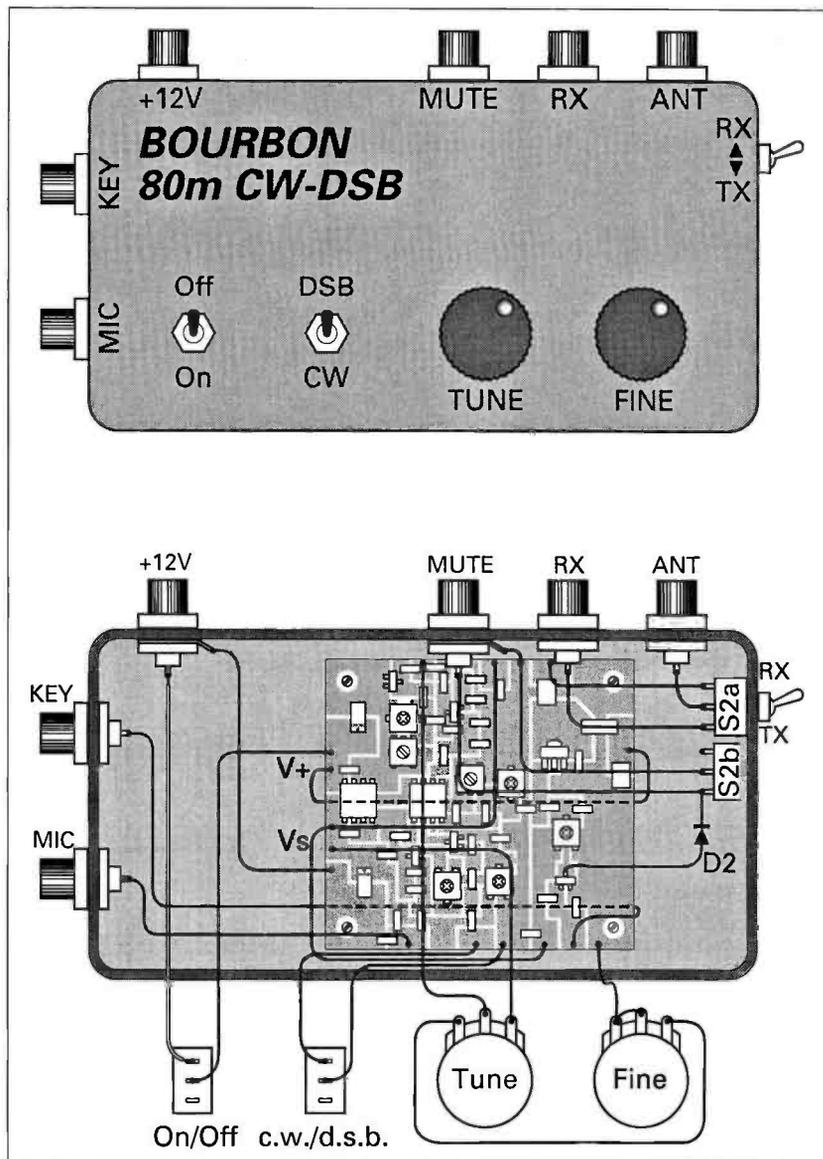

using the unit as a linear amplifier driver.

You may want to squeeze out the last bit of power as a barefoot transmitter, but watch that Tr5 does not get too hot as it will cause the frequency to drift due to D1 heating. Any receiver worth its salt should be able to get enough stray signal for netting from the v.f.o. but a stronger netting signal results if the module is in the c.w. mode. The bias on IC1 Pin 2 can be optimised for minimum residual carrier.

You should now be on the air, but on 3.5MHz you will be competing with some high power stuff and it can be a noisy band in the day time. The 'milliwatter' cannot pick and choose and must play a waiting game. Late night operation can be very rewarding but in any case a good antenna is essential. The small effort in putting together a 3W follow-on linear will be very useful and this power can be handled with s.m.d. techniques also. **PW**

Addresses of s.m.d. component and tool stockists:

Electromail,
PO Box 33,
Corby,
Northants
NN17 9EL.
Tel: (0536) 204555 or FAX: (0533) 405555.

Farnell Electronics Components,
Canal Road,
Leeds,
West Yorkshire
LS12 2TU.
Tel: (0532) 636311 or FAX: (0532) 633411.

Mainline Electronics,
PO Box 235,
Leicester
LE2 9SH.
Tel: (0533) 777648/780891
or FAX: (0533) 477551.

Maplin Electronics,
PO Box 3,
Rayleigh,
Essex
SS6 8LR.
Tel: (0702) 554161.

S.R.P. TRADING

100 Channel Scanner

£199.99

Netset PRO-46. Covers 66-88, 108-136.975 (AM), 137-174, 406-512 and 806-956 MHz. LCD display with backlight, search, priority, lockout, scan-delay, memory backup circuit. Belt clip. Requires 4 "AA" batteries or Adaptor.



50 Channel Scanner

£149.99

Netset PRO-44. Covers 66-88, 108-136.975 (AM), 137-174 and 380-512 MHz. LCD display with backlight, search, lockout, scan-delay and keyboard lock. Memory backup circuit for changing batteries. Belt clip. Requires 6 "AA" batteries or AC/DC Adaptor.

200 Channel Scanner

£219.99

Realistic PRO-39. Covers 66-88, 108-136.975 (AM), 137-174, 380-512 and 806-960 MHz. Hyperscan search and scan, 10 channel monitor back, priority, lockout, scan-delay, LCD display with backlight. Memory backup circuit. Belt clip. Requires 6 "AA" batteries or AC/DC Adaptor.



Pro 2006 £299
BACK IN STOCK

Pro 43 £249

SCANNERS

Yupiter MVT7100

JULY SPECIAL OFFER PHONE?

Yupiter MVT7000

JULY SPECIAL OFFER PHONE?

Yupiter VT225

JULY SPECIAL OFFER PHONE?

Yupiter VT125

JULY SPECIAL OFFER PHONE?

Fairmate HP2000

JULY SPECIAL OFFER PHONE?

Nevada MS1000

JULY SPECIAL OFFER PHONE?

AOR 3000A

JULY SPECIAL OFFER PHONE?

AOR 2000

JULY SPECIAL OFFER PHONE?

AOR 1500EX

JULY SPECIAL OFFER PHONE?

PRO 43

HAND-HELD SCANNER

Frequency coverage:

68-88MHz (in 5kHz steps)
118-136.975MHz (in 25kHz steps)
137-174MHz (in 5kHz steps)
220-225MHz (in 5kHz steps)
225.0125-400MHz (in 12.5kHz steps)
400.0125-512MHz (in 12.5kHz steps)
806-999.9875MHz (in 12.5kHz steps)

Channels of operation: Any 200 channels in any band combinations (20 channels, 10 banks) and 10 monitor channels.

SPECIAL OFFER PRICE
£229.95+£5P&P LIMITED STOCK



NEW SHOWROOM
NOW OPEN AT
**S.R.P. RADIO
CENTRE**
1686 Bristol Road
South, Rednal,
BIRMINGHAM
B45 9TZ
021 460 1581

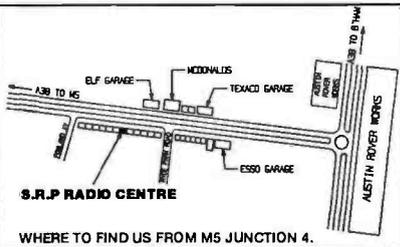

SKY SCAN

Desk Top Antenna Model Desk 1300

Built and designed for use with scanners. Coverage: 25 to 1300MHz. Total height - 36ins - 9ins at widest point. Comes complete with 4 metres of RG58 coax cable and BNC connector fitted. Ideal indoor - high performance antenna and can also be used as a car antenna when your car is static. REMEMBER YOUR SCANNER IS ONLY AS GOOD AS YOUR ANTENNA SYSTEM! £49.00 + £3.00 p&p

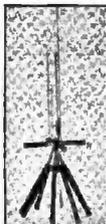

SKY SCAN V1300 Antenna

Most discons only have horizontal elements and this is the reason that they are not ideal for use with a scanner. Most of the transmissions that you are likely to receive on your scanner are transmitted from vertically mounted antennas. The Sky Scan V1300 discone has both vertical and horizontal elements for maximum reception. The V1300 is constructed from best quality stainless steel and aluminium and comes complete with mounting pole. Designed and built for use with scanners.

£49.95 + £3.00 p&p

SKY SCAN Magmont MKII

For improved performance, wide band reception, 25 to 1300MHz. Comes complete with protective rubber base, 4m RG.58 coax cable and BNC connector. Built and designed for use with scanners. £24.95 + £3.00 p&p



SRP TRADING, Unit 20, Nash Works,
Forge Lane, Belbroughton,
Nr. Stourbridge, Worcs.
Tel: (0562) 730672 • Fax: (0562) 731002

SUMMER 1993 CATALOGUE



The new enlarged Cirkit Catalogue is out now!

- 32 more pages
- New range of Kenwood 'scopes
- The latest scanning receivers and accessories
- New section of low cost security products
- Extended range of Velleman kits including: 250W 12Vdc to 220Vac inverter, in-car amplifier power supply, 200 and 400W amplifiers, suppressed lamp dimmer, halogen lamp dimmer, day/night thermostat and telephone remote control unit
- New test equipment, includes: 2.3GHz bench frequency counter, EPROM emulator/programmer, portable 'scopes and bench function generators
- Host of new components, including: compression trimmers, variable capacitors, connectors, fuses, and fuseholders, potentiometers, IC's, soldering irons and lead free solder
- Published 27th May 1993
- Available from most large newsagents or directly from Cirkit
- **Send for your copy today!**

£1.90
+ 30p p&p

Cirkit



CIRKIT DISTRIBUTION LTD

Park Lane · Broxbourne · Hertfordshire · EN10 7NQ
Telephone (0992) 444111 · Fax (0992) 464457

The Tiny Tim 3.5MHz Transceiver

Part 2

Construction

This month Tim Walford G3PCJ describes how to link the transmitter into the receiver he showed you last month.

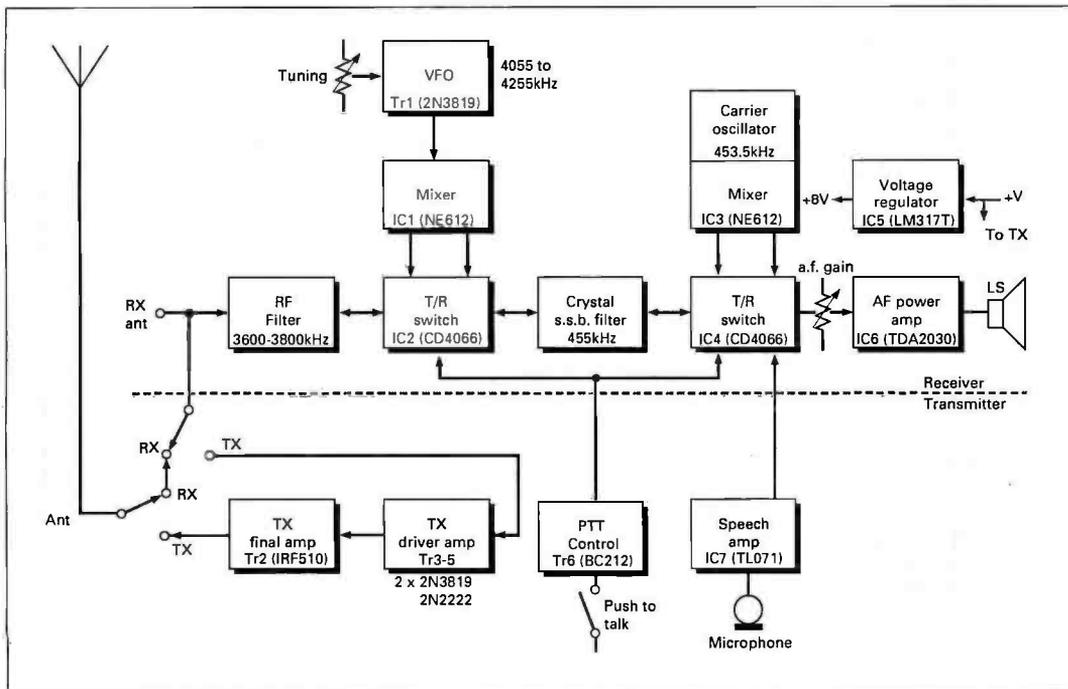

Just to make life easier, the block diagram has been reproduced again. As you can see there is no separate s.s.b. generator for the transmitter, instead the signal flow through the receiver is reversed and fed to the transmitter r.f. amplifier. This is achieved primarily by the transmission gates, which act as switches between the r.f. and i.f. filter and the two mixer i.c.s. The input and output impedances of the NE612, IC1 & 2, are each 1.5k Ω . That is sufficiently close to the 2k Ω impedance of the i.f. filter to allow it to be connected to either the mixer input or output as required for transmission or reception. Relays could be used to do this, but transmission gates are cheaper, smaller, neater, more reliable and have negligible power consumption!

The speech amplifier, IC7, will work with practically any type of microphone. Output from the speech amplifier is fed to the product detector IC3 that acts as a balanced modulator on transmit. It generates the double sideband carrier at 453.3kHz. After going back through the transmission gate, IC4, the i.f. filter removes the unwanted sideband from the signal. The single sideband signal then goes to the r.f. mixer, IC1, via IC2. The mixer, IC1, converts the frequency up to 3.5MHz. The r.f. filter, comprising T1, L3, C27, C28, C29 and C30, removes the unwanted mixer image (as it also does on receive). The transmission gates are controlled by the two signals on points D and E.

Resistor R10 keeps line E high (at +8V) on receive whether or not the transmitter parts are fitted. On receive, line D is low at 0V via resistor R9. On transmit, both lines change so that line E is low and line D high.

The p.t.t. switch, which grounds the p.t.t. line, turns on Tr6 thus energising the two relays used for changing over the transmitter output and changing lines D and E. The transmitter signal leaves the r.f. filter at a high impedance point requiring the use of an f.e.t., Tr5, as the next stage. This operates in the common source mode. Its drain load is the 10k Ω Drive Level pre-set, R27, that allows the r.f. gain to be adjusted so that clipping does not occur in the final

r.f. amplifier.

A 1mH r.f. choke is used in parallel with the pre-set resistor R27 to keep the drain d.c. voltage at +8V. This choke has to be of very good quality (high Q at 3.7MHz) in order to reduce the potential (and required) gain. Again an f.e.t., Tr4, is required to act as a buffer to drive the next stage, Tr3, which is an emitter follower. It is used to give a very low impedance drive to the output f.e.t. gate to overcome its high capacitance.

To achieve 10 to 12W p.e.p. on 12V supplies, Tr2, the IRF510 output stage, needs a drain impedance of 12.5 Ω . I wanted a tuned output stage with a Q of 12, so that output low pass filters would not be required. The solution adopted is an LC network. It needs high voltage capacitors that, luckily, come with a 1% tolerance, so there is a very good chance that the output inductance, L4, will have the right number of turns on it first time!

The mic gain control, R32, in the speech amplifier is advanced to the point where signal clipping occurs in the output of the r.f. mixer, IC1. This provides r.f. speech compression or higher 'talk power'. The troublesome harmonics this produces are safely removed by the bandpass r.f. filter following the mixer. The drive control is used to make certain r.f. clipping does not occur in the final output stage. Clipping in this stage usually causes splatter and a 'wide' transmitted signal that cannot be cleaned up.

The maximum output power increases as the square of the supply voltage, so if your d.c. supply can produce say 20V, then you will be able to obtain about 25W p.e.p. Bear in mind, that to get this higher output power, you will need to increase the r.f. drive to the final stages as well as using a 20V supply. Supply voltages up to 25V can be tolerated, but transmitter output power is really limited by the heat dissipation of Tr2 - 18 to 20V is a sensible upper limit after you have got it going and checked it out on 12V.

Due to factors beyond our control, we were not able to describe building the project in this part. But we will do so in the next part of the Tiny Tim Transceiver.

Practical **motorist**

d.i.y. for drivers

IN THE NEW LOOK AUGUST ISSUE

WIN
A BRAND NEW
CAR FOR
FREE

- New Features
- Moneysavers
- PM Test Cars: Three Years On
- Cleaner, Greener Motoring
- August Issue On Sale July 15
Still Only £1.70

MOT INSIGHT

Changes in recent years have made the MOT test considerably more stringent. We go behind the scenes to look at the 1993 test requirements and how they are viewed by the motor industry.

ACTIVE SERVICE

PM sees, from the inside, how the motoring organisations operate both at home and abroad.

VAUXHALL CAVALIER SUPERSERVICE

One of the most popular cars of recent years comes under the unique PM Superservice spotlight.

THE BUYING GAME

August means the annual flood of new car registrations and the resulting upswing in used car sales. PM investigates the market, from the car showroom to the used car lot.



**THE NEW LOOK PRACTICAL MOTORIST
AUGUST EDITION ON SALE THURSDAY, JULY 15**

Published by PW PUBLISHING Ltd., Arrowsmith Court, Station Approach, Broadstone, Dorset BH18 8PW.
Telephone (0202) 659910 • Fax (0202) 659950

The Palomar PK-44 Keyer



Christopher Page G4BUE, has tried out an interesting electronic keyer from the USA and shares his thoughts on an interesting c.w. accessory.

Whenever a new keyer comes onto the market I start wondering if it's better than the MFJ-4843C Grandmaster Keyer that I use for general day-to-day operating. So when I had the opportunity to try the Palomar PK-44 electronic keyer at home for a few weeks, I took it.

The first thing that impresses you when you open the box, is the quality of the packaging. Additionally, everything you need to get the equipment working is included, in this case two standard jack plugs.

Operator's Manual

I regret that I cannot be so complimentary about the operator's manual. The 'manual', (and I call it that because that is what Palomar call it), consists of a folded sheet of double A4 low quality paper.

It's poorly printed only the two inside pages contain any useful information and one of those is taken up with the circuit diagram!

The Keyer Itself

Like all Palomar products I've seen, the keyer is very well constructed. It's contained in an attractive black case with a grey front panel, which matches several other Palomar products. A PP3 9V battery is connected in a spring holder on the rear panel. I wasn't sure if I liked the positioning of the battery when I first saw it. However, once the battery was fitted and the unit placed in its operating position, it didn't bother me. It's also easy to replace!

There's no off switch on the PK-44, but with the key paddles open the battery should last its full shelf life. This makes the keyer ideal for Field Day and portable operations.

Connections for a key and the transmitter are provided on the rear panel in the form of a standard jack plug. Units produced for the European export market are fitted with standard 6.3mm jack sockets, whereas those produced for the domestic USA market are fitted with the smaller ones used there.

The front panel contains the speed, volume, weight and pitch controls as well as a tune/auto/semi control. With the switch in the 'auto' position the keyer is fully automatic. The keyer is fully iambic, and when the dash paddles are held together alternating dots and dashes are sent. Dots and dashes are self-completing.

The keyer has a dot memory to prevent lost dots. If a dot is called for too soon (e.g. before a space is over), the keyer remembers this and inserts a dot at the proper time. A dash memory works in a similar way for dashes.

With the switch in the 'semi' position, the keyer is semi-automatic in that dots are made automatically but dashes have to be made manually, like a bug key.

When the switch is in the 'tune' position the relay contacts remain closed for the transmitter tuning.

The volume and pitch controls are for the built-in loudspeaker. I didn't use these, as I preferred to use the sidetone of my TS-930 transceiver.

The circuit of the keyer is designed around the Curtis 8044 chip. Apart from the front panel controls, there are very few other components.

The PK-44 manual claims that most modern transmitters can be keyed without difficulty. Despite this, some transmitters may present a heavy inductive or capacitive load and may cause the keyer relay to stick. If relay problems occur, you should disconnect the transmitter and make a string of dots to try and free the contacts. You can then put a resistor, (1k Ω or as large as possible whilst still keying the transmitter properly), in series with the keyer lead.

I didn't experience any difficulty using the keyer with either my TS-930 or TS-440. There were no problems either on an older Drake TR6 (50MHz rig), using grid block keying.

Setting the keyer up is quite straight forward and I found the internal loudspeaker useful for setting the weight control prior to actually trying it on the air.

Weight Setting

I found it best to keep the weight setting on the 50:50 position. This was regardless of whether I was sending slow c.w. for QRP QSOs or high speed during contests.

I would have liked to have had the facility of decreasing the weight control below the 50:50 fully counter-clockwise position for high speed c.w. QSOs. This is where an over-emphasised short dot can give your signal some individuality and therefore an advantage in contests.

The keyer itself is a pleasure to use. The controls have a nice feel to them, are smooth and easy to operate and I had no difficulty in correctly sending at high speeds.

I find that if a keyer or a paddle is not designed or adjusted properly, an extra dot gets inserted between the '4' and the 'B' of my callsign. The Palomar PK-44 passed this test even at the maximum speed, which is probably somewhere around 60w.p.m. and much too fast for me to send general c.w.!

The relay contacts in the keyer are designed for 1A or in the words of the distributors, "to work with anything and never breakdown". Whilst this is very satisfying, the price paid for this facility is for the relay to be a little noisy.

Overall Impression

My overall impression of the PK-44 keyer is that it's a very well manufactured product that sends good Morse. It's very relaxing to use, and due to its design is unlikely to suffer from many (if any) breakdowns.

My thanks for the loan of the Palomar PK-44 go to Bredhurst Electronics Ltd., High Street, Handcross, West Sussex, RH17 6BW. Tel: (0444) 400786; who are the UK distributors and can supply the Palomar PK-44 at £89.95 inc. VAT plus £3 P&P. PW

Review

RST LANGREX SUPPLIES LTD RST
PHONE DISTRIBUTORS OF ELECTRONIC VALVES FAX
081 684 TUBES AND SEMICONDUCTORS AND I.C.S. 081 684
1166 1 MAYO ROAD · CROYDON · SURREY CR0 2QP 3056
24 HOUR EXPRESS MAIL ORDER SERVICE ON STOCK ITEMS

AZ31	4.00	EL95	2.00	PY800	1.50	6BA7	5.00	6SK7	3.00
CL33	8.00	EL360	18.50	PY801	1.50	6BE6	1.50	6SL7GT	4.50
E880C	6.95	EL509	10.00	QOV02-6	19.50	6BH6	2.50	6SN7GT	4.50
E180F	1.50	EM34	10.00	QOV03-10	5.00	6BJ6	2.25	6S57	3.00
E880C	6.95	EM81	4.00	QOV03-10 Mull	15.00	6BN6	2.00	6U8A	1.50
E180F	4.50	EM84	4.00	QOV03-20A	25.00	6B07A	3.50	6V6GT	3.00
E810F	25.00	EM87	4.00	QOV05-40A Mull	40.00	6BR7	6.00	6V4	3.00
EARC80	1.95	EN91 Mull	7.50	QOV03-12	10.00	6BR8A	4.00	6X5GT	2.50
EB91	1.50	EY51	3.50	U19	10.00	6BS7	6.00	12A7T	2.25
EBF80	1.50	EY86	1.75	UABC80	1.50	6BW6	4.50	12AU7	2.25
EBF89	1.50	EY88	1.75	UBF89	1.50	6BW7	1.50	12AX7	3.00
EEL31	12.50	EZ80	1.50	UCH42	4.00	6BZ6	2.50	12AX7A GE	7.00
EC91	6.50	EZ81	1.50	UCH81	2.50	6C4	1.95	12BA6	2.50
ECC33	4.00	GY501	3.50	UCH82	2.00	6C6	5.00	12BE6	6.50
ECC35	7.50	GZ32	6.50	UCL83	3.00	6C96A	3.00	12BH7A GE	6.50
ECC81	2.25	GZ33	4.50	UF99	2.00	6CD6GA	5.00	12BY7A GE	7.00
ECC82	2.25	GZ34 GE	7.50	UL41	12.00	6CL6	3.75	12E1	20.00
ECC83 Siemens	3.00	GZ37	4.50	UL84	2.00	6CG7 GE	6.25	12HG7 12G7	6.50
ECC85	3.50	KT61	7.50	UY41	4.00	6CH6	5.00	30FL1/2	1.50
ECC88	4.75	KT66	12.50	UY85	2.25	6CW4	8.00	30P19	2.50
ECC91	2.00	KT88	3.50	VR105/30	45.00	6H6	2.50	300B(PR)	120.00
EF80	1.50	NT8	9.00	VR150/30	2.50	6D5	17.50	57Z8	70.00
ECH35	3.50	OA2	2.70	Z759	35.00	6D06B	12.50	805	50.00
ECH42	3.50	OB2	2.70	Z803U	25.00	6EA8	3.50	807	5.00
ECH81	3.00	OC3	2.50	Z021	3.50	6EH5	1.85	811A	18.50
ECL80	1.50	OD3	2.50	Z828	20.00	6F6	3.50	812A	52.50
ECL82	2.50	PCF80	2.00	4CX250B EIMAC	75.00	6GK6	4.00	813	27.50
ECL83	3.00	PCF82	1.50	4CX250B STC	45.00	6H6	3.00	833A	85.00
ECL86 Mull	2.50	PCF86	2.50	5R4GY	6.00	6H6	4.95	865A	25.00
ECL800	25.00	PCF801	2.50	5U4G	5.25	6J5	3.00	872A	20.00
EF37A	3.50	PCF802	2.50	5V4G	4.00	6J6	3.00	931A	25.00
EF39	2.75	PCL82	2.00	5Y3GT	2.50	6J7	4.00	2050A GE	10.00
EF40	5.00	PCL83	3.00	5Z3	4.00	6J86A GE	17.50	5763	10.00
EF41	3.50	PCL84	2.00	5Z4GT	2.50	6J86C	20.00	5814A	4.00
EF42	4.50	PCL85	2.50	6AH6	4.00	6J86C GE	15.00	5842	12.00
EF80	1.50	PCL86	2.50	6AK5	4.50	6K6GT	3.00	60R0	6.50
EF85	1.50	PL805	2.50	6AL5	1.00	6K7	4.00	6146B GE	15.00
EF86	7.50	PD500	6.00	6AM6	1.95	6K8	4.00	6550A GE	15.00
EF91	1.95	PL36	2.50	6AN5	5.00	6KD6 GE	16.50	6883B GE	16.00
EF92	2.15	PL81	1.75	6AN8A	4.50	6L6G	8.50	6973	11.00
EF183	2.00	PL82	1.50	6AQ5	3.25	6L6GCSYL	9.50	7025 GE	7.00
EF184	2.00	PL83	2.50	6AR5	25.00	6L6G Siemens	4.50	7072A GE	17.50
EL32	1.50	PL84	2.00	6AS6	6.00	6L6G GE	9.50	7169	10.00
EL33	6.00	PL504	2.50	6A37G	9.50	6L7	3.50	7360	25.00
EL34 Siemens	6.00	PL508	5.50	6AT6	2.00	6LQ6	20.00	7581A	12.00
EL36	4.00	PL509	6.00	6AU5GT	5.00	6O7	4.00	7586	15.00
ELL80	25.00	PL519	6.00	6AU6	2.50	6RHH8/6KN8	12.00	7587	23.00
EL81	5.00	PL802	6.00	6AW8A	4.00	6SA7	3.00	7868	12.00
EL84	2.25	PY81	1.50	6B7	4.00	6SC7	3.00	8068	25.00
EL86	4.75	PY88	2.00	6B8	4.00	6SGM	2.50	8417GE	17.50
EL91	2.00	PY500A	4.00	6B86	1.50	6S7	3.50		

VISA OPEN TO CALLERS MON-FRI 9AM - 4PM. CLOSED SATURDAY
 QUOTATIONS FOR ANY TYPES NOT LISTED.
 OVER 6000 TYPES AVAILABLE FROM STOCK.
 OBSOLETE ITEMS A SPECIALITY.
 TERMS C W O / VISA / ACCESS
P&P 1-3 VALVES £1.00, 4-6 VALVES £2.00 ADD 17.5% VAT TO TOTAL INC P&P

Airband listening plus
 AOR - Specialist manufacturer of communications equipment

AR1500EX - One of many receivers & products produced by AOR. The very compact AR1500EX hand-held wide range receiver offers all mode reception including SSB as standard. Newly designed printed circuit boards have been incorporated to ensure this new version offers the very best performance. Frequency range is 500 kHz ~ 1300 MHz without gaps, all mode reception AM, FM(N), FM(W) & SSB (USB, LSB & CW - with BFO). The AR1500EX offers full coverage of the VHF, UHF and Shortwave Airbands plus Broadcast, Amateur band, Utility services etc. Many accessories included: NiCad pack, Charger, Dry battery case, DC lead, Soft case, Belt hook, DA900 VHF-UHF aerial, SW-wire aerial, Earphone, Comprehensive Operating manual... **Suggested Retail Price of £349.00 inc VAT.** (UK Carriage free)

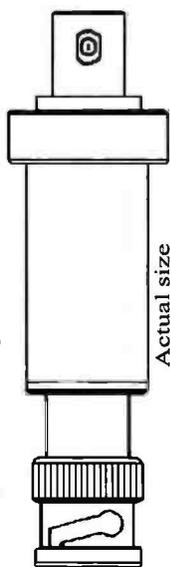

New ABF~125
VHF Air Band Filter for better strong signal performance...
 The ABF125 is a receive bandpass filter especially designed to improve the strong signal handling characteristics of receivers for VHF commercial Airband listening. The ABF125 is suitable for connection to most airband and wide range receivers on the market, it is not designed just for AOR branded products. The addition of this filter to the aerial signal path will provide additional selectivity which will enable the receiver's circuitry to cope much more easily with strong interfering signals such as Band-2 Stereo or Shortwave broadcast transmissions which can be manifest in many ways such as 'hissing', mixing of many signals together, music breakthrough and desensitisation of the receiver. **Suggested Retail Price £24.50 inc VAT.** (UK Carriage £1.50)
 Many other receivers and products are available from the AOR range. Please phone or send a large S.A.E. (34p) for full details. Dealers throughout Europe... fast mail order available for direct orders.
 AOR UK Ltd is a subsidiary of AOR Ltd Japan. E&OE.

AOR AOR (UK) Ltd. Adam Bede High Tech Centre, Derby Road, Wirksworth, Derbys. DE4 4BG. Tel: 0629 - 825926 Fax: 0629 - 825927

WHEN IT'S DOWN TO HIGH PERFORMANCE S.A.S. THERE IS SIMPLY NO OTHER CHOICE!

FROM 80M MONOBAND BEAMS TO 13CM LOOPS - WE OFFER THE CHOICE

cushcraft

A4S20-15-10m 4el Beam
 A3S20-15-10m 3el Beam
 A3WS17-12 3el Beam
 R740-10m 1/2w Vertical
 R520-10m 1/2w Vertical
 AP880-10m 1/2w Vertical
 A50-56m 5 Element Beam
 17B22m 17el Boomer
 13B22m 13el Boomer
 124WB2m 4el Boomer
 ARX2B2m Co-linear
 ARX45070cm Co-linear
 AR2702m/70cm Vertical
 A430-1170cm 11el Beam
 LAC1Lightning Arrester

hy-gain

TH7DX20-15-10m 7el Beam
 TH5DX20-15-10m 5el Beam
 EXP1420-15-10m 4el Beam
 TH3JR20-15-10m 3el Beam
 TH2mk220-15-10m 2el Beam
 DX6680-10m Vertical
 14AVQ40-10m Vertical
 88DX6m 6el Beam
 64DX6m 4el Beam

ROTATORS

T2XTaitwister Rotator
 HamIVThe "classic" Rotator
 CD45Medium duty Rotator

MIRAGE/KLM

KT34XA20-15-10m 6el Beam
 KT34A20-15-10m 4el Beam
 6M76m 7el Beam
 6M56m 5el Beam
 2M16LBX2m 16el Beam
 2M13LBA2m 13el Beam
 2M22C2m 11XY Oscar
 2M14C2m 7XY Oscar
 432-3070cm 30el Beam
 435-40X70cm 20XY Oscar
 435-18C70cm 9XY Oscar
 440-670cm 6el Beam
 JV-66m 5dB Vertical

VHF/UHF pre-amps also available

M² ENTERPRISES

6M76m 7el Beam
 6M56m 5el Beam
 2M18XXX2m 18el Beam
 2M5WL2m 17el Beam
 2M122m 12el Beam
 EB1442m Eggbeater
 432-13WL70cm 39el Beam
 432-9WL70cm 28el Beam
 EB43270cm Eggbeater
 23QM3523cm 35el Beam
 2M2P2m 2w Power Divider
 2M4P2m 4w Power Divider
 70CM2P70cm 2w P. Divider
 70CM4P70cm 4w P. Divider
 23CM4P23cm 4w P. Divider

GEM QUAD

GQ-2-320-15-10m 2el Quad
 GQ-3-320-15-10m 3el Quad
 GQ-4-320-15-10m 4el Quad

17 & 12m Add-on kits also available.

15-12-10m "MINI QUAD" available soon

MIRAGE AMPLIFIERS

A1015G5m 10-150w g/f rx
 B23G2m 2-30w g/f rx
 B215G2m 2-150w g/f rx
 B108G2m 10-80w g/f rx
 B1016G2m 10-160w g/f rx
 B2516G2m 25-160w g/f rx
 D15N70cm 2-20w
 D26N70cm 2-60w
 D1010N70cm 10-100w
 D3010N70cm 30-100w

HEIL SOUND

HM-10Boom/Desk microphone
 BM-10Lightweight headset
 HC4/5Microphone insert

"THE ULTIMATE IN SSB SPEECH ARTICULATION"

Please ask for details of the full range of Heil Products

DOWN EAST MICROWAVE

LOOP YAGI AND TRANSVERTER KITS for 13 and 23cm and much more.

Please ask for full details.

THE ABOVE ARE SOME OF OUR MORE POPULAR LINES PLEASE SEND SAE FOR FULL DETAILS

TEL: 0691 670440 SPECIALIST ANTENNA SYSTEMS LTD FAX: 0691 670282
TREFONEN, OSWESTRY, SHROPSHIRE SY10 9DJ

As this issue is the PW 'Antenna Special' it seems very appropriate to feature an antenna 'personality'. Louis Varney G5RV certainly fits into that category, and Rob Mannion G3XFD didn't want to miss the chance of meeting the inventor of the famous 'G5RV' antenna!

RADIO PERSONALITY

LOUIS VARNEY G5RV

The G5RV story goes back a long way, so I was fascinated to hear it direct from Louis himself. It all seems to have started in the early 1920s.

Louis told me: "In 1922, when I was 11 years old, I became a Boy Scout and one of the first things I did was to obtain my 'Signaller Badge', because the Morse Code fascinated me. At the same time, I made my first crystal detector wireless set and was soon listening to amateurs on 440 metres.

I joined the RSGB and became BRS102. In 1927, my old friend Jack Hum G5UM, who was also a BRS at that time, and I had exchanged correspondence about obtaining an 'Artificial Aerial' transmitting licence. This was in order to experiment with oscillating crystals. Not quartz, but the normal receiving zincite, bornite, galena, carborundum and other types coaxed into oscillation by the judicious application of a suitable d.c. polarising voltage! This idea was born as a result of an article published in *Amateur Wireless*, August 9 1924.

Both Jack and I obtained the covered permits. His call was 2AJI and mine was 2ARV. In 1928 we both graduated to 'full' licences. Jack became G5UM and I became G5RV.

My main interest was always in antennas and feeder systems. I tried most types and I can still remember my very first QSO, which was on 45 metres c.w. with EAR16!

I joined the Marconi Wireless Telegraph Company at Chelmsford, Essex in 1930. I was 19 years old, and was employed as a Technical Assistant, later graduating to Engineer.

PRESENTED TO MARCONI

During my apprenticeship I, along with several other fellow TAs was presented to Guglielmo Marconi, during one of his periodical visits of inspection to the Marconi Works.

In the mid-1930s Mr A. W. Ladner (co-author with C. R. Stoner of *Short Wave Wireless Communication* in 1932) selected

me to be his Assistant at the Marconi College in Chelmsford, of which he was Principal. Many of our students were technicians sent to us by clients all over the world, and some were also radio amateurs.

At school I had always been an enthusiastic scholar of French and Spanish. In 1955, the Marconi Company was looking for an engineer fluent in Spanish to be appointed as its Latin American and Caribbean Technical and Commercial Representative resident in Caracas, Venezuela, for three years.

I was selected, and lived there until August 1958. My duties required frequent visits to the Latin American countries and to all the major islands of the Caribbean. I was able to obtain amateur radio licences and permission to operate as a guest operator, in many South and Central American countries and Caribbean islands.

In 1960 I was invited to join the firm of Consulting Engineers, Preece, Cardew and Rider. The partners were looking for a French-speaking, qualified radio engineer, to work near Paris for three years on a v.h.f., u.h.f. and microwave radio network extending from Norway to Eastern Turkey. I accepted and subsequently, my career as a Consulting Engineer in Telecommunications took me all over the world.

I was VK9LV while working in Papua New Guinea for two years, with frequent visits to the VK2, 3, 4 and 5 districts. Island hopping took me to many more rare places, among them YJ8RV in what was then the New Hebrides and FOORV in Tahiti. The 14, 21 and 28MHz bands seemed to explode wherever I called CQ DX!

Stopping off in Chile, Argentina, Uruguay and Brazil I added more call signs to my collection, including CX5RV. I still use it every European winter when, with my wife Nélide, I spend four months in the sun at Piriapolis on the coast.

I have been a keen horse rider since my youth. So, living for four to five months every year in Uruguay for the past 17 years, I hired a 'Gaucho' (cowboy) horse. But, perhaps of more interest, I sometimes operated as 'CX5RV/Horseback Mobile' for QSOs with local CXs!

I keep a permanent station in Piriapolis with my trusty TS-520, and a full size G5RV antenna (of course!). My favourite operating mode has always been c.w., but I occasionally use s.s.b.

During our last two visits I kept a daily c.w. sked on 21.021MHz c.w., with my old friend Bert G2FIX near Salisbury. We never failed to make contact, even on the few days when conditions to Europe were poor! After this sked, which only lasts for about 10 to 15 minutes, I always call CQ UK and listen carefully for replies.

OCTOBER FALL

In late October 1992, I had the misfortune to fall 4m to the ground while pruning the upper branches of one of our large apple trees here in Sussex, when the ladder slipped! Luckily, no bones were broken, but I had bad bruising and slight concussion. We had to cancel our trip to Uruguay, but hope to go this November.

I am sometimes asked when I designed and made the G5RV antenna. Actually, it was when we got our licences back in 1946 after the Second World War. But I did not write an article about it for several years, partly because I was very busy with other work.

I have always been fascinated by the Morse code. When the First Class (c.w.) Operators Club was re-formed in 1946, I was a Founder Member (FOCT) together with nine others. I was elected President of the club for 1984.

I still enjoy h.f. experimental work on antennas and feeder systems. But, apart from my life-long interest in radio, both amateur and professional, I have three other hobbies: cooking, linguistics and oil painting.

During the three years I lived and worked in France, I learned *haute cuisine* while helping at weekends in a superb restaurant. It was owned and run by my dear friends Rene F3NM and his wife Germaine in Beauvais. I also learned Chinese and Indian Cooking!

Working in so many countries gave me unique opportunities to learn Italian and Portuguese and even to obtain a working knowledge of Pidgin English, used in Papua New Guinea. My wife, Nélide, is from Uruguay and her native language is Spanish, but she also speaks the same group of languages, so we have no communication problems!"

And, thanks to Louis Varney G5RV's antenna design...radio amateurs don't have many problems communicating either. I've no doubt that everyone will join me in wishing G5RV continuing good health - and that he avoids climbing and falling from apple trees!

G3XFD

Louis Varney G5RV



GOT PROBLEMS WITH YOUR RIG?

Call Castle for Immediate Assistance!

We are now fully authorised and equipped to repair, service and maintain, all rigs by...

**ICOM YAESU
KENWOOD ALINCO**

Call **CASTLE** on
0384 298616

and tell us your symptoms!

Full workshop facilities plus a new, computer controlled spares store, we are now No.1 in UK! We can arrange for collection and delivery direct to your own QTH. Average turn round 7-10 days. (Trade enquiries welcome)

3 MONTHS GUARANTEE ON OUR OWN WORK

Castle Electronics

Geoff G4AQU John G6VJC

Tel: 0384 298616

Fax: 0384 270224

Unit 3, "Baird House", Dudley

Innovation Centre, Pensnett Trading Estate
Kingswinford, West Midlands DY6 8XZ



**ELECTRONICS
VALVES
& SEMICONDUCTORS**

Phone for a most courteous quotation

081-743 0899

Fax: 081-749 9394

Telex: 917257

We are one of the largest stockists of valves etc, in the U.K.

COLOMOR (ELECTRONICS) LTD.

170 GOLDHAWK ROAD
LONDON W12 8HJ

LICENCED 1962

G3RCQ ELECTRONICS

RAOTA

I BUY AND SELL

TOP QUALITY AMATEUR RADIO EQUIPMENT

Telephone Dave (0708) 374043 (Eves & W/End) or Alan (0268) 752522 (Daytime)

9 Troopers Drive, Harold Hill, Romford, Essex
Callers by appointment, Part exchange welcomed!
73s de Dave

BW BARKER & WILLIAMSON INC BW

Manufacturers of Quality Commercial Equipment and Components since 1932
UNIQUE CONTINUOUS COVERAGE ANTENNAS FOR COMMERCIAL

AND AMATEUR SERVICE MODEL BWD1.8-30

Only 90 feet long

ONLY £249.95 inc VAT

P&P £5.00 Made in U.S.A.

See Feb 'Practical Wireless'

U.S. Patent No 4423423

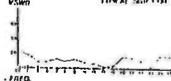

- ★ Used by commercial stations, expeditions etc. because of rugged design and construction, ease of installation and operation.
- ★ SWR 2:1 or better from 1.8-30MHz → see curves — No ATU needed.
- ★ Completely assembled. Terminated with SO-239 connector.
- ★ Rated 1kW 2kW ICAS. ★ Fully weatherproof.
- ★ Wind and ice survival. 150 mph and 80lbs with 3 pole support.
- ★ Send SAE for further details.

As used by the 1991 Everest balloon flight team.

Also co-ax switches, portable aerials and the famous B&W air wound inductor stock all described in the B&W catalogue. Send 50p to the appointed UK distributor for your copy.

World Student Games special event station GB91WSG reported "great success" using a BWD1.8-30.

RF ENGINEERING LTD Tel: 0451 844237
Woelf of Lake House, Sherborne, Gloucestershire, U.K. GL54 3PR Fax: 0451 844253

SOUTH ESSEX COMMUNICATIONS LTD

USED EQUIPMENT

SX400	350.00
PRO80 SONY	200.00
SX200 JIL SCANNER	175.00
UBC175 BEARCAT	175.00
PS60 ICOM 30A PSU	350.00
ICR7000 SCANNER	875.00
CN620A METER	75.00
D2935 HF RECEIVER	175.00
AKDHFCQNV	50.00
FTV707 2mtr TXVR	175.00
D2935 HF RECEIVER	150.00
POCOM MEMORY	150.00
IC R71+FM HF RX	750.00
IC229E 2m MOBILE	275.00
TS440SAT+FILTERS	895.00
PS50 KENWOOD	175.00
LPM50-10-100	200.00
FRG 8800 HFRX	550.00
AR 2000 SCANNER	249.00
FT209R 2m HANDIE	150.00
TS 930S HF TCVR	895.00
IC 2SRE 2m HANDIE	450.00
ICR 72 HF RECEIVE	699.00
FT 901DM HF TCVR	450.00
DIAWA PS300 PSU	125.00
MFJ962C 1.5kWATU	225.00
MFJ931 GROUND	75.00

YAESU PT890+ATU	£1200.00
YAESU PT767GX	£1450.00
YAESU FT530	£399.00
YAESU FRG100	£499.00
ICOM ICR71	£899.00
ICOM ICR728	£800.00
ICOM ICR1	£399.00
ICOM IC737	£1295.00
KENWOOD TS450+ATU	£1249.00
KENWOOD TS690	£1200.00
KENWOOD TH77	£345.00
KENWOOD TH26	£219.00

JUST A FEW PRICES AVAILABLE TO YOU
PLEASE CALL FOR PRICES ON OTHER
MODELS ALL GOODS SUPPLIED ARE NEW

JUST LOOK BELOW AT A SMALL SELECTION OF THE RANGE OF OUR MOBILE ANTENNAS AVAILABLE

NR77S	2m/70cms 2.5dB 0.39m	£29.95
NR770H	2m/70cms 3dB/5.5dB 0.99m	£38.41
NR770R	2m/70cms 3dB/5.5dB 0.99m	£39.95
NR770S	2m/70cms 2.5dB 0.43m	£30.17
NR790	2m/70cms 4.5dB/7.2dB 1.46m	£64.95
NR7700	2m/70cms 3dB/5.5dB 1m	£54.86
NR1100N	2m/70cms 23cms 2.15dB/5.5dB	£49.95
NR2000N	2/70/23cms 3.15/6.3/9.7dB	£69.95
PU77B	2m/70cms 2dB 0.22m	£47.55
SG7900	2m/70cms 5dB/7.6dB 1.58m	£89.95
SG9500N	2m/70/23cms 3.5/6.3/9.7dB 1m	£97.84
TSM1303	2m/70cms 3.5dB/6dB 1.05m	£32.95
TSM1309	2m/70cms 3dB/5.5dB 0.93m	£28.35
TSM1313	2m/70cms 3.5dB/5.6dB 0.94m	£26.51
TSM1314	2m/70cms 3.8dB/6.2dB 1m	£26.51
TSM1315	2m/70cms 4.2dB/6.8dB 1.26m	£54.86
TSM1316	2m/70cms 2.15dB/3.8dB 0.44m	£21.94
TSM1318	2m/70cms 3dB/5.5dB 0.895m	£26.51
TSM1326	2m/70cms 2.15dB/5dB 0.775m	£23.78
TSM1328	2m/70cms 3dB/5.5dB 0.95m	£27.43
D505	0.5MHz-1.5GHz 20dB Mob FX	£94.95

Prompt mail order service, finance facilities available, interest free credit on selected items. Prices correct at time of going to press, E&OE

VAST RANGE OF ACCESSORIES NOW
BEING STOCKED, NEW STOCKS ARE
ARRIVING EVERY WEEK

£5 - £10 - £25 GIFT VOUCHERS NOW
AVAILABLE FROM US TO SPEND ON
WHAT YOU LIKE WHEN YOU LIKE IN
OUR STORE.

THESE MAKE AN IDEAL GIFT

**ICOM YAESU KENWOOD ALINCO
STANDARD JRC AND MANY
MORE STOCKED**

FROM DRESSLER

2 metre and 70cm
rf-vox switched Masthead
pre-amps

EVV2000 HDX

Gain 3 to 21 dB
(adjustable inside)
Noise 0.7 - 0.8 dB
200w ssb vox
750w ssb ppt

EVV700 HDX

Gain 4 to 20 dB
(adjustable inside)
Noise 0.8 - 0.9 dB
100w ssb vox
500w ssb ppt
Price £159.00 each

SOLE UK IMPORTERS

DRESSLER ACTIVE ANTENNAS

ARA60 Active Antenna
50KHz-60MHz with
limited performance up to
100MHz **£169**

ARA1500 50MHz-1500MHz

Frequency 50-1000 11.5dB
100-1500 11.0dB

£169 - 'N' connection

SHORTWAVE ACTIVE ANTENNA ARA60

940mm high 64mm diameter complete
with cable + PSU and interface **£169.**

Now fully tuneable interface. Intercept
point + 21dBm

OUR LOCAL AGENTS

DAVE (Eastcote, Leics)
0533 608189;
STUART (Bromley, Kent)
081-313 9186;
TERRY (Biggleswade, Beds)
0767 316431

TRADE ENQUIRIES WELCOME
FROM BONE-FIDE DEALERS
CALL FOR LATEST TRADE PRICE LIST



Opening hours:
Mon-Fri 9:00am-5:30pm
Sat 9:30am-4:30pm

191 Francis Road, Leyton, London, E10 6NQ
Telephone: 081-558 0854 081-556 1415
Fax: 081-558 1298 Telex: 8953609 lextion G

V21/22 22bis
Mailbox and BBS
After office hours
on 081-556 1415

24 hour hotline
ansaphone on
081-558 0854

Having been a dedicated, maniacal loop antenna designer and experimenter for many years, Richard Q. Marris G2BZQ describes a pre-amplifier kit* for use between coaxial loops and shows how the range can be extended to cover the m.w. and 1.8-3.5MHz bands.

WIDE-BAND VLF/LF/MF AMPLIFIERS & COAXIAL LOOP ANTENNAS

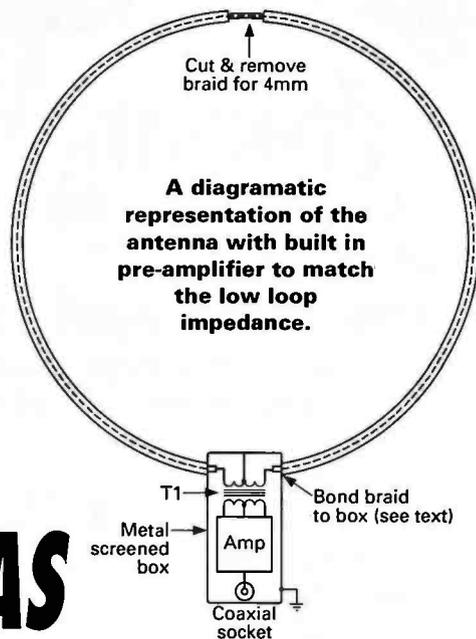

Back in 1987, I read a write-up describing the H-86 pre-amplifier kit circuit by Ralph Burhans. The H-86 is a 10-400kHz kit for use as a pre-amplifier between coaxial loops and receivers. The kit then cost \$25.

It was even more interesting to me, because many years ago, at this QTH, experiments were conducted along similar lines using two valve (r.f. pentode with cathode follower) pre-amplifier, plus power unit, that used a large multi-tapped output audio transformer, to match the loop to the amplifier input. It was highly successful for v.l.f., l.w., m.w. reception, apart from the fact that it weighed as much as the accompanying receiver!

There is the GOOD and the BAD about using an untuned coaxial screened loop, with a wide-band pre-amplifier. The GOOD is that no tuning is involved, and one loop covers the whole frequency range. The BAD is that the loop and amplifier are wide-band/untuned giving a near certainty of signal breakthrough from a local high power station or one of its harmonics.

The advantage of a coaxial shielded loop, is that the ambient noise is considerably lower than any other receive antenna type. Also it is directional thus eliminating or reducing QRM/QRN by simple rotation.

The interesting thing about the H-86 was the use of a miniature 1:5 turns ratio audio transformers (primary and

secondary centre tapped) as input and output matching transformers. The balanced input circuit T1 covers inputs of about 1 to 10Ω impedance, and the loop is connected across the low impedance winding. Half of the other winding (P) is connected to a two-stage amplifier using a J310 and 2N3904.

The other half, of this winding marked AUX can be used to connect a signal generator or for an auxiliary long wire antenna if required. A similar type output transformer is used to connect the amplifier to the 50/70Ω receiver input via coaxial feedline. The amplifier gain was said to be 30-35dB.

In the circuit, capacitors C1 and C3 provide a low pass filter with about 400kHz roll off; and L1 and C2 are a wave trap to filter any interfering local signal (or harmonic). Two or more such wave traps could be fitted in series if more than one signal is breaking through. The L1 and C2 combination will obviously have to be resonated at the frequency of the offending signal or harmonic.

Ralph Burhans said that for use on medium wave or the 1.8-3.5MHz bands, T1 and T2 could be replaced with home-brew transformers using a few turns of wire on Amidon FT50-75 cores. It seems that in this case, the values of C1 and C3 in the low pass filters would have to be reduced or eliminated.

An f.e.t./bipolar cascode amplifier circuit gives low input impedance and high gain. Power is supplied down the coaxial lead to the receiver.

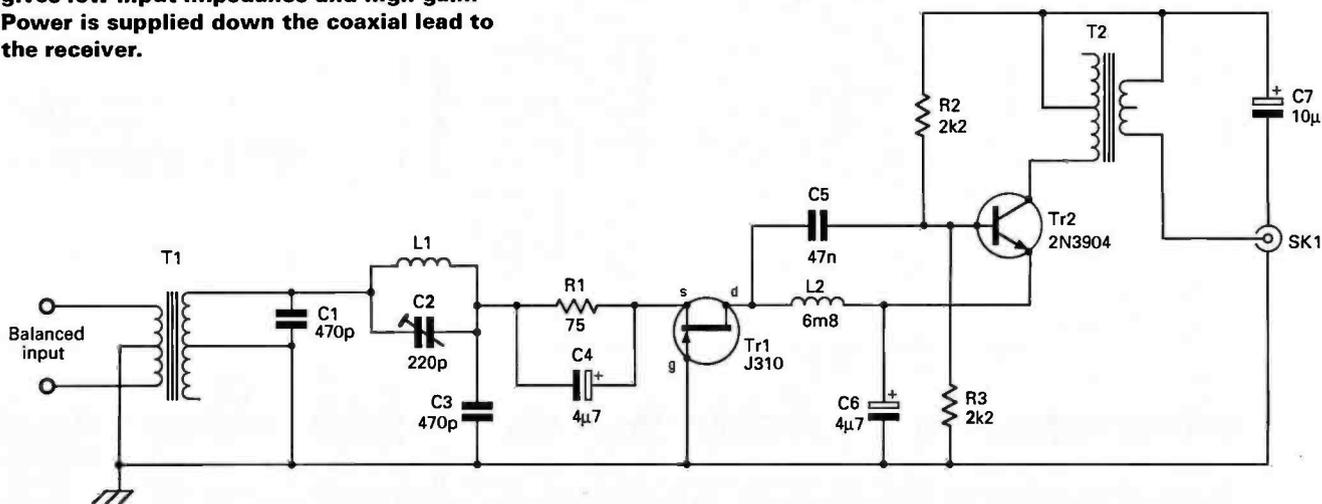

For the convenience of interested readers, a sketch is shown of a suggested coaxial shielded loop, which has been used here in the past, together with suggested amplifier mounting position in a base metal box.

The loop could be anything between 1 and 3m diameter, depending on space available. At the summit of the loop about 4mm of the copper shielding braid is removed, with the inner insulated conductor left intact. The bottom of the loop is secured to a metal box containing the amplifier. The loop copper braiding should be bonded to the box, and the inner conductor going through the holes to T1. The mechanically ambitious could manufacture the loop using copper tubing and the rod! Mere mortals should note that it has been found here, that if a largish diameter coaxial feedline cable, such as UR67 is used, then with 1m diameter, it will only require one vertical wood support, whereas a larger diameter will require a more elaborate wooden framework. The simplest way to bond the loop to the box has found to be to use PL259 plugs at each cable end, and 2 x SO259 chassis sockets at the box.

There seems to be no obvious reason why this technique (amplifier/loop) should not be adapted to the h.f. bands using carefully designed input/output transformers.

* Ralph Burhans of Burhans Electronics,
161 Grosvenor St, St Athens, Ohio 45701, USA.

PW

FURTHER READING

'VLF Up-Converter' by Adrian Knott G6KSN
pp 38-40, *PW* February 1993 (back issue £2.00 or
reprint 85p inc. P&P).

'The *PW* VLF Converter' by Mike Rowe G8JVE
p28 onwards, *PW* November 1986 (reprint 85p inc.
P&P).

'The Largest Antenna In The World' by Brian Dance
pp 40-41 *PW* September 1983 (reprint 85p inc. P&P).

Jeorg Klingenfuss publishes several books on
the stations that use the v.l.f. bands. Look for
Guide To Facsimile Station (£18.00 plus £1.00 P&P
UK or £1.75 P&P overseas), and *Guide To Utility
Stations* (£24.00 plus £1.00 P&P UK or £1.75 P&P
overseas).

An order form to order any of the above items is
available on the Book Services pages.

There is a group of people who would like to
use the v.l.f. band for communication purposes in
Caving research and rescue. For more details
contact Cave Radio and Electronics Group, c/o
Davis Gibson, 21 Well House Drive, Leeds LS8 4BX.
Tel: (0532) 481218.

Radio Diary

*Practical Wireless & Short Wave Magazine in attendance.

***July 10:** The Cornish Rally will be held at Penair
School, Truro. **Barrie Thomas G0NRR** on (0872)
862046.

July 11: Galway Experimenters Club will be holding its
Annual Radio & Computer Rally at Newtownshere,
Galway. Doors open at 12 noon, large trade show,
Bring & Buy, free parking & refreshments available.
Talk-in on S22. **E1701B** on 091-53592.

July 11: The Sussex Amateur Radio & Computer Fair
will be held at Brighton Racecourse. Doors open at
10.30am to 4pm. Trade stands, Bring & Buy, picnic
area, refreshments & car parking. Free Bus service to
Brighton Sea Front. (0273) 501100

July 25: Colchester Radio & Computer Rally (including
Car Boot Sale), St. Helena School, Sheepen Road,
Colchester. **Frank G3FIJ** on (0206) 851189.

July 25: Norfolk Amateur Radio Club & Hewett School
Radio & Electronics Group will be holding their rally
at the Hewett School, Hall Road, Norwich. Doors
open 10am. Admission £1 adults,
OAPs/disabled/children 50p. Free parking. Trade
stands, Bring & Buy, displays. **Sheila G0KWP** on
(0603) 618810.

August 1: The 10th McMichael Rally & Car Boot Sale
will be held at the Haymill Youth & Community Centre,
Burnham Lane, Slough (nr. Burnham Railway Station).
Doors open 10.30am, admission is £1.50. Car boot sale
is £6 per pitch on the day. Free parking on site & talk-
in on S22. **Neil G0SVN** on (0628) 25952.

August 8: Derby Mobile Rally will take place at the
Littleover Community School, Pastures Hill, Littleover,
Derby. Usual attractions, including the famous
monster junk sale. It is hoped to provide improved
facilities for disabled visitors in 1993. **Martin
Shardlow G3SZJ** on (0332) 556875.

***August 8:** Flight Refuelling ARS Hamfest will take
place at the Flight Refuelling Sports Ground, Merley,
Wimborne, Dorset. Doors open 10am to 5pm. Usual
mix of traders, Bring & Buy, craft exhibitors, Car Boot
Sale & field events. Overnight camping facilities
available for Saturday 7th. Talk-in on S22. **Richard
Hogan G4VCQ** on (0202) 691021.

August 8: The Third Wirral Amateur Radio &
Computing Rally will be held at the Masonic Hall,
Manor Road, Wallasey. Doors open 11am. D. G.
Clifford on 051-639 5922 or **D. Roberts** on 061-476
3076.

August 29: Castle Hall Computer, Electronics & Radio
Rally will be held at Castle Hall Exhibition Centre,
Stalybridge, Cheshire. Doors open at 11am to 4pm
(10.30 for disabled visitors). Over 200 stalls, Bring &
Buy, refreshments available. Talk-in on S22. **Enquiries**
to 061-681 0569.

August 30: Coleraine & District ARG Radio Rally &
Bring & Buy will be held in The Golf Links Hotel,
Portrush. From 12 noon to 5.50pm. Traders welcome
free of charge, food & refreshments available.
Admission £1. Talk-in S22. **Raymond G14MFM** on
(0266) 558230.

August 30: Huntingdonshire Amateur Radio Society
will be holding their Annual Bank Holiday Monday
Rally at St Germain Street, Huntingdon (easy to find,
drive around the ring road until you find us!). Doors
open at 10am, admission £1, free car parking. Talk-in
on S22. **David Leech G7DIU** on (0480) 431333.

September 5: Milton Keynes & DARS will be holding
their 7th Annual Radio Boot Sale at Cranfield Airfield,
Cranfield, Beds. **Ray G1LRU** on (0908) 660798.

September 5: Vange Amateur Radio Society Annual
Rally will be held at the Laindon Community Centre,
Laindon High Road/Aston Road, Laindon, Basildon,
Essex. Doors open from 10.30am. Admission 75p.
Trade stands, Bring & Buy, raffle, refreshments, car
parking. Talk-in on S22. Sign-posted approach roads.
Mike Musgrave G4NVT on (0268) 543025.

***September 11:** The Scottish Amateur Radio
Convention will be held in Cardonald College, 690
Mosspark Drive, Glasgow G52. Full trade show,
lecture theatres, Bring & Buy, Morse tests, bar &
restaurant. Free parking. Talk-in on S22. **Tom Hughes
GM3EDZ** on 041-882 5753.

***September 12:** Lincoln SWC Hamfest will be held at
Lincolnshire Showground & Exhibition Centre, four
miles north of Lincoln on A15 Lincoln/Scunthorpe
Road. Doors open 10.30am. Usual trade stands, Bring
& Buy, refreshments, licensed bar. Lots of attractions
for whole family. Admission £1 by lucky programme,
free parking, caravans welcome by arrangement.
Talk-in on S22. **Denis G1XZG** on (0522) 684214.

September 12: The BARTG Rally will be held at
Sandown Exhibition Centre, Esher, Surrey. Bring &
Buy, refreshments, many exhibitor & special interest
groups. Doors open 10.30am to 5pm. Admission,
adults £1.50 & OAPs £1, under 14s free if
accompanied by an adult. Well sign-posted. **Peter
Nicol** on 021-453 2676.

September 18: The Annual Isle of Wight Wireless
Rally will be held at the National CEM Wireless
Museum, Arretton Manor, Nr. Newport, Isle of Wight.
Doors open at 11am. Bring & Buy, refreshments,
covered accommodation if wet. Free admission for
all, including traders, free parking. Talk-in on S20 by
G310W. **Douglas G3KPO** on (0983) 567665.

September 26: The Harlow & District Amateur Radio
Society will be holding its 35th Annual Amateur Radio
Rally & Computer Show at Harlow Town Sports
Centre, off Fifth Avenue Harlow (easy access off M11
Junction 7, A414 follow the signposted route). Doors
open at 10.30am. Admission £1, OAPs & children 50p.
Varied selection of traders, Bring & Buy, free parking
at & near to the site. Disabled parking & lifts
available. **Mike G7BNF** on (0850) 487863.

October 10: The Computercations 1993 Amateur
Radio & Computer Rally will be held at Hillhead
Campsite, Kingswear Road, Brixham, Devon. Trade
stands for computer & radio, Bring & Buy, raffle,
refreshments. Unlimited free parking with overnight
camping available. Talk-in on S22. **Bill Trezise G6ZRM**
on (0803) 522216.

***November 6 & 7:** The Seventh North Wales Radio &
Electronics Show will be held at the Aberconwy
Conference Centre, Llandudno. Doors open at 10am
on both days. Admission £1, children under 14, 50p. **B.
Mee G7WEXH** on (0745) 591704.

December 5: Leeds & District Amateur Radio Society
will be holding its rally at Allerton High School, King
Lane, Leeds. Four large main halls, talk-in on S22,
catering facilities. **Richard Tillotson G7HUE** on (0532)
552344 or FAX (0532) 393856.

*If you're travelling long
distances to rallies, it could be
worth 'phoning the contact
number to check all is well,
before setting off.*

WHERE CAN I BUY ... A DIRECTORY OF ANTENNA SUPPLIERS

AA&A LTD.,

Sycamore House,
Northwood,
Wem,
Shropshire SY4 5NN.
Tel: (0948) 75666 or
FAX: (0948) 75668.

Look out for the three peaks logo of this company at rallies. If you can't see the logo, look out for the biggest magnetic loops in the hall, as they are suppliers of magnetic loop antennas, a.t.u.s, and the Variable Frequency Antenna. The latest product from AA&A is the ALC-1 Automatic Loop Controller which can control any d.c. motorised magnetic loop antenna at the touch of a button (prices available on request). They can also supply, through Nevada Communications, 189 London Road, North End, Portsmouth, Hampshire PO2 9AE. Tel: (0705) 662145, capacitors and roller coasters for making your own a.t.u.

AERIAL TECHNIQUES,

11 Kent Road,
Parkstone,
Poole,
Dorset BH12 2EH.
Tel: (0202) 738232.

If DX commercial radio/television is your interest then this is for you. Aerial Techniques are suppliers of TV/f.m. DXing equipment including high gain TV antennas for all v.h.f. and u.h.f. bands, mast head amplifiers, signal measuring equipment, up-converters, satellite equipment, rotators and general antenna hardware. A 34-page catalogue is available for £1.

ALTRON COMMUNICATIONS LTD.,

Unit 1 Plot 20,
Business Park,
Cross Hands,
Llanelli,
Dyfed SA14 6RB.
Tel: (0269) 831431 or FAX: (0269) 845345.

Readers of *Practical Wireless* may already know of Altron for their tubular masts and lattice towers, but they also manufacture a compact four-band mini-beam antenna. The AQ6-20 'Spacesaver' antenna which covers 14, 21, 28 and 50MHz, could be the answer for your small garden. Send a large s.s.a.e. (with a 36p stamp on it) to the above address for a copy of their catalogue.

AMDAT,

4 Northville Road,
Norville,
Bristol,
Avon BS7 0RG.
Tel: (0272) 699352 or FAX: (0272) 236088.

Amdat provide a range of computer software for amateur radio. YAGICAD, written by Paul McMahon VK3DIP, is one of their programs. It an easy to use, simplified version of those described in *PW* May 1993 and is limited to modelling free-space Yagi antennas. The results are displayed as E or H polar diagrams or frequency swept F/B, gain and impedance graphs. This program is excellent value at only £3.50 plus P&P.

AOR (UK) LTD.,

Adam Bede High Tech Centre,
Derby Road,
Wirksworth,
Derbys DE4 4BG.
Tel: (0692) 825926 or FAX: (0629) 825927.

Scanners, so popular these days, require special wide-band antennas. In addition to all their scanners, AOR also supply the following:

AOR's LA320
Active Loop
Antenna

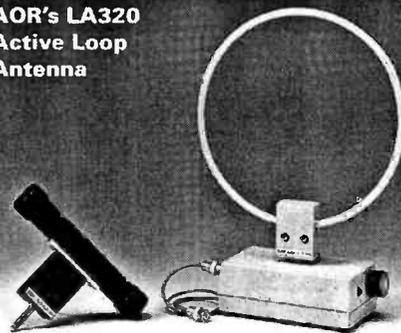

DA3000 16-element discone antenna, 25 to 2000MHz.
WA7000 Ultra wide band active antenna 30kHz to 2000MHz.
LA320 Short wave table-top active antenna, 1.6 to 15MHz.

BARENCO,

27 Park Road,
Barnstone,
Nottingham NG13 9JF.
Tel: (0949) 60607 or FAX: (0949) 60773.

Barenco may be found at many rallies selling cables and accessories, rotators and hardware plus other products. Barenco manufacture much of the hardware they supply.

BRICOMM,

5 Mickle Meadow,
Water Orton,
Birmingham B46 1SN.
Tel: or FAX: 021-747 5077.

This company can supply you with a catalogue of all the items of mounting hardware and cables they sell. Send an A5-sized s.s.a.e. When you find what you need in the catalogue, they can take it to a rally near you for collection, saving you the postage.

BREDHURST ELECTRONICS LTD.,

High Street,
Handcross,
West Sussex RH17 6BW.
Tel: (0444) 400786/400124 or FAX: (0444) 400604.

Bredhurst are the sole importers of the patented GAP Elevated Launch technology h.f. vertical multi-band antennas from the USA. The Challenger DX-VI has full bandwidth on 7, 14, 21, 28, 50 and 144MHz and 130kHz on 3.5MHz. The Voyager DX-IV has full bandwidth on 3.5, 7 and 14MHz and 90kHz bandwidth on 1.8MHz.

CIRKIT DISTRIBUTION LTD.,

Park Lane,
Broxbourne,
Herts EN10 7NQ.
Tel: (0992) 444111 or FAX: (0992) 441306.

Cirkit are well-known for mail order, and their catalogue is available in many newsagents. They can supply capacitors, coils, roller coasters, turns counters and cable for making your own antennas. Alternatively, you can purchase one of their finished antennas.

C.M. HOWES COMMUNICATIONS,

Eydon,
Davenry,
Northants NN11 6PT.
Tel: (0327) 60178.

Three active receiver antennas are available in the Howes Kits range. The Howes AA2 covers the long, medium and short wave bands. The Howes A44 covers from 25 to 1300MHz and is a neat alternative to the discone antenna. The Howes AB118 is

optimised for v.h.f. airband reception from 118 to 137MHz.

The Howes CTU30 is an a.t.u. for the listener or for QRP transmissions up to 30W. A choice of two optional hardware packs are available, one of which can take an s.w.r. bridge kit and an r.f. operated side tone kit.

DATONG ELECTRONICS LTD,

Clayton Wood Close,
West Park,
Leeds LS16 6QE.

Tel: (0532) 744822 or FAX: (0503) 742872.

For the short wave listener Datong Electronics offer the AD270/370 range of compact active antennas. These antennas give similar receive performance to large conventional antenna systems yet are only three metres long. The frequency range is from 200kHz to 30MHz.

The AD270 uses two wire elements and is designed for indoor use. The AD370 has two 1.5 metre stainless steel taper elements for outside use.

A head unit of both antennas contains an amplifier and matching system.

EASTERN COMMUNICATIONS,

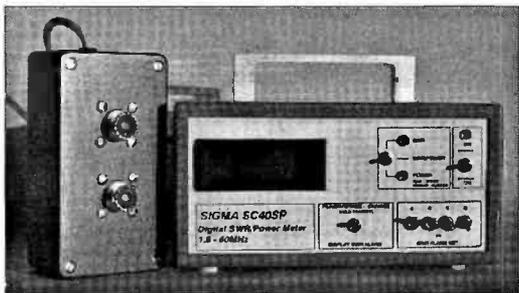

Cavendish House,
Happisburgh,
Norfolk NR12 0RU.

Tel: (0692) 650077 or FAX: (0692) 650925.

Eastern Communications are the European distributors of Sigma Communications Products. The Sigma SC40SP covers from 1.6 to 60MHz. Peak or average s.w.r. or power are monitored. If the s.w.r. reading exceeds a set point an alarm sounds.

GAREX ELECTRONICS,

Station Yard,
South Brent,
South Devon TQ10 9AL.

Tel: (0364) 72770 or FAX: (0364) 72007.

A range of v.h.f./u.h.f. antennas are available from their associate company REVCO. The mobile antennas come in three mounting systems, Permanent, Temporary and Glassmount.

Antennas bases can be supplied for permanent installations requiring a hole being drilled in the vehicle. The temporary mount uses boot-lip, gutter, roof-rack or magmounting. Popularised by the cellular industry, glassmounts are convenient, neat and easily transferable.

Antennas are available for the following v.h.f./u.h.f. bands:

27-29MHz	144-146MHz
50-52MHz	430-440MHz
70MHz	

An interesting foldable, portable Slim Jim (Jimp) antenna is also available.



The isoloop 10-30HF

ICS ELECTRONICS LTD.,

Unit V,
Rudford Industrial Estate,
Ford Arundel,
West Sussex BN18 0BD.

Tel: (0903) 731101 or FAX: (0903) 731105.

ICS import Advanced Electronics Applications Inc (AEA) equipment from the USA. Among these antenna products is the IsoLoop 10-30 HF. This antenna is only 890mm in diameter and covers 10 to 30MHz. AEA also have the IsoPole range of broad band v.h.f. antennas for 144 and 440MHz. These verticals have a 10 and 22MHz bandwidth, respectively, and a gain of 3dBd.

JANDEK,

6 Fellows Avenue,
Kingswinford,
West Midlands DY6 9ET.

Tel: (0384) 288900.

Derrick Pearson G3ZOM, produces a range of kits for the radio amateur. For the antenna experimenter there is the JD021 HF Dip Oscillator, described Antenna Workshop, PW June 1993. For measuring impedance (resistance and reactance) the JD031 noise bridge, should be available very soon.

LAKE ELECTRONICS,



7 Middleton Close,
Nuthall,
Nottingham NG16 1BX.

Tel: (0602) 382509.

Already well-known for his range of QRP transceiver kits Alan Lake G4DVW also produces a range of antenna tuning units, s.w.r. meters and a power meter. These items can be supplied as a kit or ready made. The TU2 was reviewed by George Dobbs G3RVJ in SWM November 1989. The TUA1 QRP s.w.r. bridge was reviewed in PW November 1992.

LOWE ELECTRONICS LTD.,

Chesterfield Road,
Matlock,
Derbyshire DE4 5LE.

Tel: (0629) 580800 or FAX: (0629) 580020.

Lowe Electronics is an importer of a whole range of antenna and associated equipment as follows:

Butternut antennas from the USA, including verticals HF6V and HF2V and the well-known HF5B Butterfly beam. Tonna v.h.f./u.h.f. antennas (if you want to see how an antenna brochure should be produced send for Tonna info). The Hokushin range of antennas from Japan are available along with the Emotator range of antenna rotators.

A wide range of UK antennas such as Jaybeam and Cushcraft are also stocked as well as a Static Wick Discharger AS1. This device, when fitted to the element of an antenna, is claimed to reduce static discharge noise by several dB even under normal weather conditions. Send a s.a.e. for info on the AS1 and article 'Electrostatic Receiver Noise: Causes and Prevention'.

MAPLIN ELECTRONICS,

PO Box 3,
Rayleigh,
Essex SS6 8LR.

Tel: (0702) 554161.

Maplin Electronics' 1993 catalogue, is available through many newsagents for £2.95. It contains many pages of antennas, fixing brackets, other hardware, cables and coaxial switches. The catalogue also contains many other radio and electronic

ANTENNAS

The Tu1 a.t.u.
produced by Lake
Electronics.

products, including s.w.r./power meters, active antennas and tuners.

NEVADA COMMUNICATIONS,

189 London Road,
North End,
Portsmouth,
Hampshire PO2 9AE.

Tel: (0705) 662145 or FAX (0705) 690626.

Already well-known for radio equipment, Nevada also stock an extensive range of antennas for transmitting and receiving. They can supply a wide range of Scanmaster products including the Scanmaster Magnetic Mobile, Scanmaster Discone and the soon to be released range of Scanmaster v.h.f. mobile antennas. A catalogue dealing with these and their other products is available for £2 from the above address.

PDSL,

Winscombe House,
Beacon Road,
Crowborough,
Essex TN6 1UL.

Tel: (0892) 663298 or FAX (0892) 667473.

The PDSL (Public Domain and Shareware Library) can supply from their extensive library, many programs to run on IBM PC or compatible computers. Among these programs are: 'Wire' and 'Yagimax' version 3. Both programs can help you to improve your antenna set-up and you can also use the propagation predictor programs. A catalogue is available from PDSL at the above address.

PRIVATE MOBILE RADIO LTD.,

Industrial Estate,
Gwaelod-Y-Garth
Cardiff CF4 8JN.

Tel: (0222) 810999.

PMR stock a comprehensive range of antenna products from several manufacturers including, Cushcraft, Diamond, Comet, Tonna, Jaybeam, Yaesu and Icom. For further details on their products contact, PMR direct.

Q-TEK,

R. Benham-Holman G2DYM,
Cobhamden,
Uplowman,
Tiverton,
Devon EX16 7PH.

Tel: (0398) 6215.

This company are suppliers of resin-encapsulated, pre-tuned dipole traps for the 3.5 - 28MHz bands. They also manufacture and supply the G2DYM Aerial Matching Unit. Send an A4 s.s.a.e. (36p stamp) to G2DYM direct for more information about the products.

RF ENGINEERING,

Woefully Lake House,
Sherbourne,
Gloucestershire GL7 5AN.

Tel: (0451) 844237 or FAX (0451) 844253.

Gloucestershire-based RF Engineering are distributors of Barker & Williamson products from America. These antenna and associated items are designed and built to a very high standard. The company supplies silver-plated air-wound coils and high flash-over rated capacitors, suitable for a.t.u. use. They also produce a suitcase-sized antenna for the h.f. bands. Other products available include a range of economically priced baluns for most applications including G5RV antennas from the American company Communication Devices, a range of commercial quality static discharge electro-magnetic pulse shunts from Signal Systems in the USA. A catalogue is available by sending in an A5 sized s.s.a.e. (with a 36p stamp) to the above address.

SANDPIPER COMMUNICATIONS,

Unit 5,
Enterprise House,
Cwmbach,

Aberdare,

Mid Glamorgan CF44 0TU.

Tel: (0685) 870425 or FAX (0685) 876104.

This company is a manufacturer of antennas for all bands and situations. They are particularly well-known for their rally attendance. Their range of antennas is growing all the time, but they can supply an up-to-date catalogue on receipt of an A4 sized (36p stamp) s.s.a.e. to the above address.

SOUTH MIDLANDS COMMUNICATIONS LTD.,

S M House,
School Close,
Chandlers Ford Industrial Estate,
Eastleigh,
Hampshire SO5 3BY.

Tel: (0703) 255111 or FAX (0703) 263507.

Although best known for their Yaesu amateur radio equipment, SMC are active throughout the world in the communications and antenna field. The company supplies commercial masts, towers and hardware in conjunction with a design service. They have recently acquired Jaybeam Amateur and will continue to provide the high level level of technical spares and sales support under the banner JB Antennas. In the amateur radio context, SMC has many years of antenna expertise to offer, backed by a large choice of specialised hardware, including the famous Strumech Versatower.

SPECIALIST ANTENNA SYSTEMS LTD.

Trefonen,
Oswestry,
Shropshire SY10 9DY.

Tel: (0691) 670440 or FAX: (0691) 670282.

Antennas from 3.5MHz to 2.3GHz, that's what SAS say they provide. On h.f. there are verticals from Cushcraft, such as the R5, R7 and AP8 and the DX88 and the 14AVQ from Hy-Gain. Rotatable antennas range from the D3W rotatable WARC multi-band dipole from Cushcraft to the monster TH7DX 14, 21, 28MHz, 7-element beam from Hy-Gain.

SAS also import the Gem Quad. This quad uses special construction glass fibre supports which combine lightness and strength. There are 2, 3 and 4-element versions for 14, 21 & 28MHz with optional elements for 18 and 24MHz. Look out for the 'Mini-Quad', available soon.

VHF antennas range from the Mirage/KLM 6m 5dB vertical to the M2 Enterprises 1296MHz 35-element beam.

Send a (large) s.s.a.e. for full details.

S.R.W. COMMUNICATIONS LTD.,

Astrid House,
The Green,
Swinton,
Malton,
N. Yorks YO17 0SN.

Tel: (0653) 697513.

More usually known for the SRW Kilowatt Loudenboomer linear amplifier for the h.f. bands, SRW also supply the G3TPW CobWebb antenna. This small (about 3.5m diagonal) antenna covers the 14, 18, 21, 24 and 28MHz bands. As it's horizontally polarised and omni-directional, no rotator is required. The price of this is still only £149 (£8 P&P). Soon to be added to the SRW range of products is the Spider antenna for 10, 7, 3.5 and 1.8MHz (price available on request), and the CobWebb beam antenna for 14, 18, 21, 24 and 28MHz for approx £600. Contact S.R.W. for more details.

TENNAMAST (SCOTLAND),

Mains Road,
Beith,
Ayrshire KA15 2HT.

Tel: (0505) 53824.

If you fancy a mast, but thought they were expensive, then the Adapt-A-Mast from Tennamast starting at £150, may just be the thing you're looking for. This is the latest in a long line of masts and towers to come from this company (the Adapt-A-Mast was reviewed in *PW* November 1992). For further details on their products, contact Tennamast at the above address. PW



FANTASTIC NEWS –

We are now in a position to offer you an unbeatable bargain.

We manufacture the only antennas that **Do not** require an ATU. **Do not** need planning permission. **Do not** cause TV1 or BC1

The AA&A Magnetic loop antennas cover every single frequency from 3.4MHz (80MTS) through to 30MHz (10MTS) We have sold thousands of these antennas worldwide and they are currently used by governments, Armed forces land and seaborne, clubs and schools. We have many testimonials – just listen on the bands.

**YOU SAVE
£££**

For only*
£399.50

AMA5 80, 40, 30MTS
(1.7m Dia)
AMA3 10-20MTS
(80cm Dia)

*plus £20 carriage

Rush your cheque or telephone with card number and order now to avoid disappointment -

Remember you've tried the rest – this is the best!

Tel: 0948 75666
Fax: 0948 75668

Send SAE for details of other loops, plus SPC300/3000D VFA etc.

AA&A Ltd,
Sycamore House,
Northwood, Wem,
Shropshire SY4 5NN

Reg Ward & Co Ltd.

1 Western Parade, West Street, Axminster, Devon, EX13 5NY.
Telephone: Axminster (0297) 34918

(Largest Amateur Radio Shop in the South West)
One Stop for Yaesu · Icom · Kenwood



Kenwood TS-50

The world's smallest HF transceiver



HF TRANSCEIVERS



YAESU

FT890 Compact TXCR



ICOM

NEW IC728/IC729

IC728 HF

IC729 HF+6M

Accessories

PS55 PSU

SP7 Speaker

AT150 Auto ATU

SM8 Desk Mic

IC765 HF Base Station



IC728



TS450



TS850

KENWOOD

TS450/690

TS450 HF

TS690 HF+6M

Accessories

PS31 PSU (SSB only)

PS53 PSU (Full Duty Cycle)

SP23 Ext. Speaker

AT450 Int. Auto ATU

Kenwood TS850

PS52 PSU (Full Duty)

SP31 Ext. Speaker

AT850 in Auto ATU

MC60A Desk Mic

VHF/UHF MOBILES

Yaesu FT212RH 2m, 45 watt

Yaesu FT2400RH New 2m, 50 watt

Yaesu FT5200R 2m/70cm, Full Cross Band



FT5200R



IC3230H

ICOM IC229E/H

IC229E 2m, 25 watt

IC229H 50 watt

ICOM IC3230H 2m/70cm FM, 45/35 Watt

ICOM IC2410E/H 2/70cm FM, Dual Watch



TM241E

Kenwood

TM241E 2m, 50 Watt

TM702 2/70cm, 25W

HANDHELD

TM732 2/70cm

Yaesu FT415 2m HH inc. battery pack charger

(FT 815 70cm)

Coming Soon

Yaesu FT530 New 2m/70 Dualband Handy

Yaesu Accessories

EDC5 DC adapt Noise filter

EDC6 DC lead 26/76/415/815

MH12A2B Speaker Mic

MH18A2B Mini speaker Mic

CS05/152 (FT415/815) Carry Cases

NC42 Desk top charger

Icom ICW2 The 2/70 Dualbander

Icom IC25RE 2m + Wideband RX

ICOM Accessories

CP13 Cigar Lighter Cable

HM65 Speaker Mic

HS60 Headset/Voxor PTT

OPC288 DC lead

LC71/72/73 W2/SRE Carry Cases

Kenwood TH28 2m Handy

(TH28 70cm)

Kenwood TH78 Dual band Handy

Kenwood Accessories

AG2W DC lead

SMC32 Speaker mic

SMC33 Speaker mic multijunction

HMC2 Headset/Boom Mic

PHONE FOR PRICES

PHONE FOR PRICES

PHONE FOR PRICES

PHONE FOR PRICES

Large Second Hand Stock
Easy Parking Opposite



Instant credit available
Mail/Telephone order by cheque or credit card
Cheques cleared before goods despatched.



OPEN TUES-SAT 9.00-5.30
(CLOSED MONDAYS)
LUNCH 1-2pm

STOCK ITEMS USUALLY
DESPATCHED WITHIN 48HRS

DELIVERY/INSURANCE PRICES
IN BRACKETS
(E&OE)



DATONG
ELECTRONICS LIMITED

Clayton Wood Close
West Park
Leeds LS16 6QE
Tel: 0532 744822
Fax: 0532 742872

For products you can rely upon to give amazing results

For information on **Active Antennas, RF Amplifiers, Converters, Audio Filters, the Morse Tutor and Speech Processors** send or telephone for a free catalogue and selective data sheets as required.

All our products are designed and made in Britain.

Orders can be despatched within 48 hours subject to availability.



— VISA AND ACCESS WELCOME —



Ron Stone GW3YDX describes an effective vertical antenna for the 3.5MHz band

A DX VERTICAL ANTENNA FOR 3.5MHZ

In my constant search for a good antenna for DX working, I had tried almost everything, delta loops, high dipoles, full and half slopers, all giving reasonable performances. But none of them seemed to match the results achieved by those using big verticals on the 3.5MHz band.

In the past I'd avoided verticals out of pure sloth. The thought of ploughing in miles of radials had always put me off. But, in an unusual fit of enthusiasm, I got out the spade to dig a hole for the ground post for a vertical, and to slit the soil for a system of radials.

To judge the effectiveness of the new antenna, comparisons were made with a delta loop for 3.5MHz. As I was uncertain about the eventual results, the vertical had to be a low budget exercise, and its cost was not to exceed £50.

In the end because all the materials, except for the ground post, were to hand, the project cost just £1. This sum was the cost of a suitable piece of steel section for the post from Gerald Potter's scrapyards at Welshpool.

FULL SIZED

A full size $\lambda/4$ vertical for 3.5MHz is over 21m high, needing at least two sets of guy wires. Although there are no neighbour problems at my location, the XYL said that only one set of guys was acceptable. So a design about 16m high seemed the limit.

Experiments with physically short antennas had shown that a mixture of capacity hat and inductive loading seemed to give the best results. This method seems to retain bandwidth whilst physically reducing the size of the structure to make it easier to handle.

The design, basically sketched out in Fig. 1, was experimentally evolved. The capacity hat is formed, above the loading coil, by steel wire sections in the three guying ropes. They are electrically connected to the antenna just above the coil, about 10m from the ground. The three guys fitted have held the antenna up for six months, through winter gales with no problems.

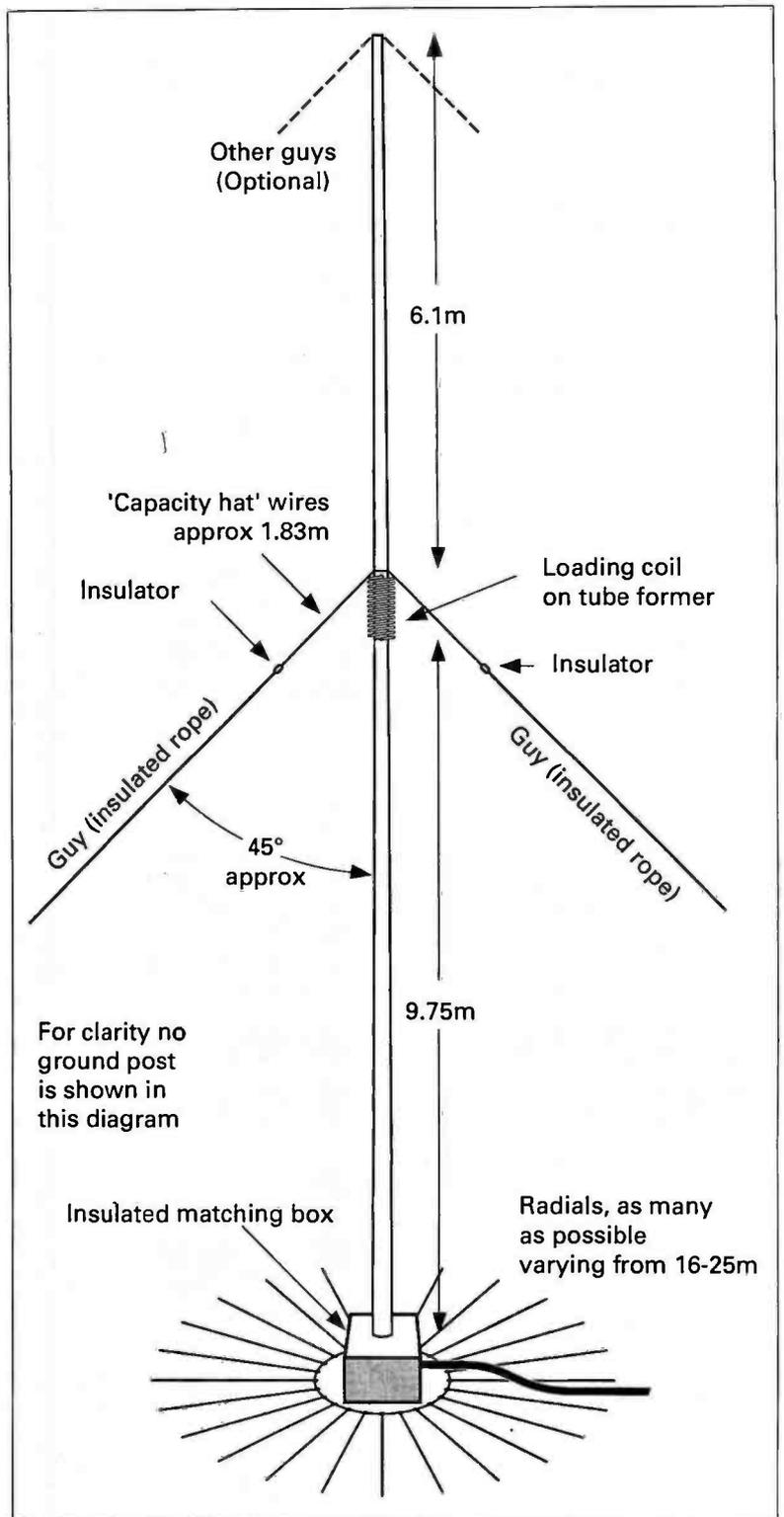

Fig.1: A simple drawing of the antenna. Each of the two vertical sections is made up of two or more telescoping section of aluminium tubing.

Construction of the antenna should pose few difficulties. The ground post was a 2.5m length of T-section steel with a wall thickness of about 6mm. Almost anything will do provided that it is wide enough at the top to take 2 1/4in exhaust clamps. The post was drilled to suit the clamps, and was hammered into the 1m deep hole, until the drilled holes at the midpoint were about 100mm, or so, above ground level.

The bottom of the vertical radiator proper was made up of two interlocked sections of tubing. A length (4.5m) of scaffold tubing with a 6m length of alloy tube (1.25in with a 16s.w.g. wall). This is a snug fit into the scaffold tube.

A 450mm length of 28mm glass fibre tube (3mm wall) becomes the joiner, for the two metal sections, and former for the loading coil. This section of tubing overlaps by about 180mm at each join to give both stability and strength.

Above this section of glass fibre tubing is a short (1m) length of 1 1/4in tubing with a 2m length of 1in tube. The top section (2.5m) of this part is from 3/4in alloy tubing

LOADING COIL

The loading coil consists of 50 turns of enamelled heavy copper wire wound on the central portion of the glass fibre former. All sections were secured with stainless steel hose clamps or self-tapping screws as required. With the capacity hat guys attached, the antenna was raised to the vertical position and secured to the ground post with the exhaust clamps. Place a brick under the bottom of the radiator to stop it from touching the ground. The guys ropes are then loosely tied, while the radiator is insulated from the ground post.

BASE INSULATION

The insulators for the base of the radiator are made from 100mm long pieces of 75mm diameter pvc drainpipe, slit lengthwise and folded around the scaffold tube under the exhaust clamps. As these are tightened the pvc tube will overlap. This insulation method is quite good enough because it is a low voltage point. The supporting brick can now be removed, and the guys tightened.

RADIAL SYSTEM

The type of wire used for the radial system is not critical. Thin wire is suitable, because the ground current will be shared between all the wires of the radial system. The length of the radials is not very critical, although the longer the better. However, it is better to have many short radials than just a few long ones.

In my design, 40 radials were laid down, varying from 16-25m in length. Burying the radial wires deep down is a myth, running along the the surface will do. In my installation they are buried 70-100mm deep, as there are animals on the land. To bury radials in the ground, make a slit with a spade and just push the radial wire in, using an old screwdriver with a 'V' shaped notch cut into the end of the blade. All the radials are brought together at a common soldered point and waterproofed with a rubber glue.

MATCHING

The next step is of course to fit the matching network/feedline to the radiator and radial system. When checked the antenna and full system of radials, was resonant at about 3.2MHz. To match the antenna to the coaxial feedline all that was required was a variable capacitor to tune out the excess inductive reactance at the desired operating frequency. As the capacitor is

present at a low voltage point, a receiving type is quite up to the job, even at 1kW p.e.p.

I use c.w. mostly, but now and then I have a foray onto s.s.b. Such excursions never last for long because of the awful QRM I find there. To make tuning easier, a relay controlled from the shack, introduces a second capacitor to suit each part of the band. There is a slight amount of residual v.s.w.r. using a single capacitor. Perhaps a slightly better match would have been obtained with an L-match network. The v.s.w.r. with the full radial system is less than 1.5:1 on both parts of the band.

An old ice cream box is used to house the tuning network, and is just big enough for the simple capacitor and relay circuit shown.

COMPARISONS

As far as the comparisons with the delta loop were concerned, as an experiment, it was decided to put the radials down in 'instalments' and to test it at each stage. Initially only four 18m radials and a single 1m earth spike were used. After a week of testing the general conclusion was that the vertical was on average one S-unit worse than the delta loop. The 'break even' point occurred with 16 radials. The two antennas were then giving roughly the same results with DX, but the vertical responded less to European signals, in itself quite a benefit.

Continuing to fit 40 radials, my back was giving me S9+ 'time-to-stop' signals, and reports were one to two S-points better than the with the delta loop. Considering the 27m top-height of the latter antenna, it is a very rewarding result.

Please don't forget to check with your planning department for the local rules and regulations about masts (and towers).

PW

HOW MUCH

Depends on metal available.

HOW DIFFICULT

Mechanical planning and building skills needed.

SHOPPING LIST

The antenna was made from 'scrap' aluminium tubing that I had available. But in general you will need various length of slide-fit aluminium tube of 1.5, 1.25, 1 and 3/4in (and possibly smaller diameters). A 400-500mm length of g.r.p. tubing will be needed to form the joiner/coil former (if this is other than the 1.125in diameter tubing that I used, you will have to experiment with the number of turns in the coil). You will need at least one 300-500pF tuning capacitor to tune the systems to resonance.

If you don't have any aluminium tubing of the right sizes to hand, consult the *Yellow Pages* directory for your local non-ferrous metal suppliers (usually under 'Aluminium Suppliers' label).

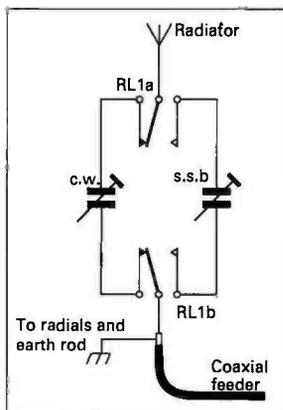

Fig. 2: Separate tuning capacitors and tune the vertical to each section of the band.

Tony Martin G4XBY, describes how he built a 9-element beam antenna

A Lightweight 9-Element Beam For 144MHz

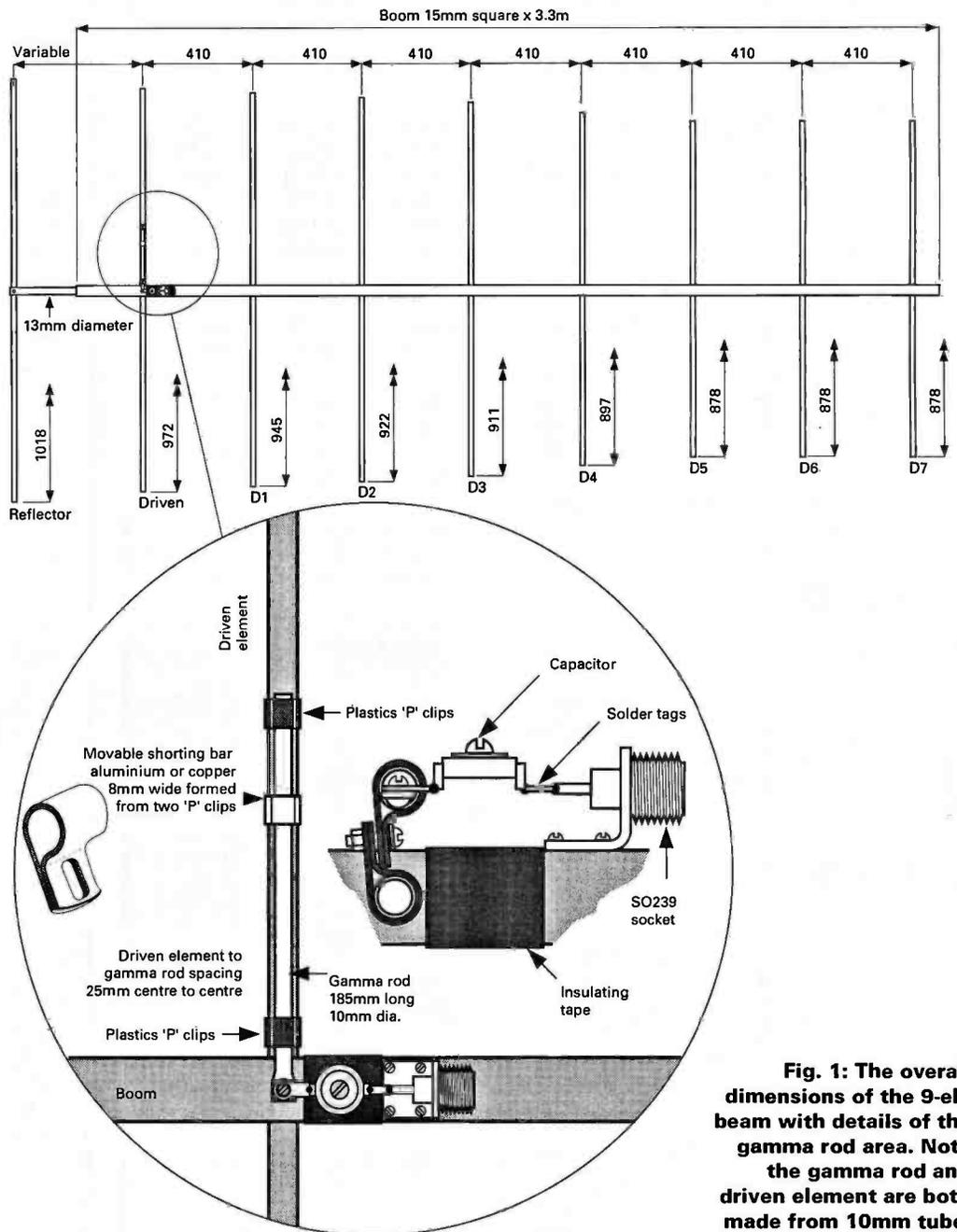

Fig. 1: The overall dimensions of the 9-element beam with details of the gamma rod area. Note the gamma rod and driven element are both made from 10mm tube.

Having found the s.s.b. section of 144MHz after a four year spell of h.f. working, I decided that I would design and build a beam antenna rather than buy a commercially produced one. The antenna was to be attached to a chimney stack and so the assembly had to be as light as possible.

The antenna project cost me about £16 to build and requires only those few tools, usually available in the handyman's toolkit. These tools should include a (power) drill, hacksaw, screwdriver, files, pliers and a hammer. A selection of drill bits up to 10mm is needed, and of course a vice and a tape measure.

Materials

Look at the diagram Fig. 1. The antenna boom is made from a piece of 15mm square box section aluminium. This type of boom material is often used for TV antennas. You will need a piece 3.3m long.

You will also need two lengths of 10mm tubing for the driven and reflector elements, as well as seven lengths of 6mm tubing for the directors. In addition you will need a 300mm length of 13mm diameter round tubing which should be a 'push fit' into the end of the box section boom. More about this later.

On the antenna, the coaxial feed is via a gamma match system using a heavy duty ceramic variable capacitor (4-110pF) bought for 25 pence at a rally.

Method

Mark out the position of the elements on the boom, making all measurements from one end. Begin by marking out the position of the front element about 20mm back from one end of the boom. Making sure that each point is on the centre line of the boom, mark out the other seven element positions at 410mm intervals.

Mark each position on the opposite side of the boom, taking care to keep the marks as accurate as possible. When all the director positions have been marked on the boom they should be drilled out using a 6mm drill bit. A drill on a bench stand make getting the holes in the correct place very easy.

Change the bit to 10mm and carefully drill the holes out for the driven element. If you do not have a drill stand, drill these holes from one side, taking care not to let the drill penetrate the other side of the metal boom. Turn the boom over and drill the second side. In both cases, keep the drill at right angles to the boom when drilling.

From the 6mm diameter rod, mark and cut each of the director elements to the lengths shown. Carefully remove any burrs with the file and mark the exact centre of each element (by cutting a nick with the saw).

On the bottom of the boom mark and drill holes for the self-tapping screws that will hold the elements in place. These holes should be drilled to suit the self-tapping screws you use. Using 10mm diameter rod, mark and cut the driven and reflector elements. Fit the driven element into the boom as above. When the elements are temporarily in the boom they should fit snugly, so the locking screw will hold the element solidly in the boom.

Hold each element tightly in position on the boom, drill through the centre point of each element with a 2mm drill. Secure each element with a self-tapping screw of about 10 - 12mm long. This last operation is best done with the boom either held in a vice or you could carry this operation out on a large flat floor. If any of the elements are slightly out of alignment, they can be carefully teased until they align.

Turning now to the reflector element. It is easier if this is fitted into the 13mm diameter tubing as shown in Fig. 2, rather than trying to drill a 10mm hole in the round section of the boom. Carefully flatten the centre section of the element and make two slots in the 13mm tube so that the element is a tight fit. Carefully align the exact centre of the element with the drilled holes and fit the locking screw.

Adjustment

Start with the reflector in the nominal position, 432mm behind the driven elements. Set the antenna up over a large flat area, and as high as possible, but so that you can still get to it to make adjustments. Adjust the gamma match section to give a low v.s.w.r.

Trimming the antenna for maximum forward gain is simple. Using low transmitter power, and a dipole field strength unit[‡], move the reflector slowly back and forth. Note the position which gives the highest field strength. Then, using self-tapping screws (top and bottom of the boom), secure the sliding rod in the boom.

If you intend to trim for maximum front-to-back ratio then the antenna has to be swung round to measure the back lobe power at each setting before fixing the sliding rod in the boom.

The antenna is now ready for use.

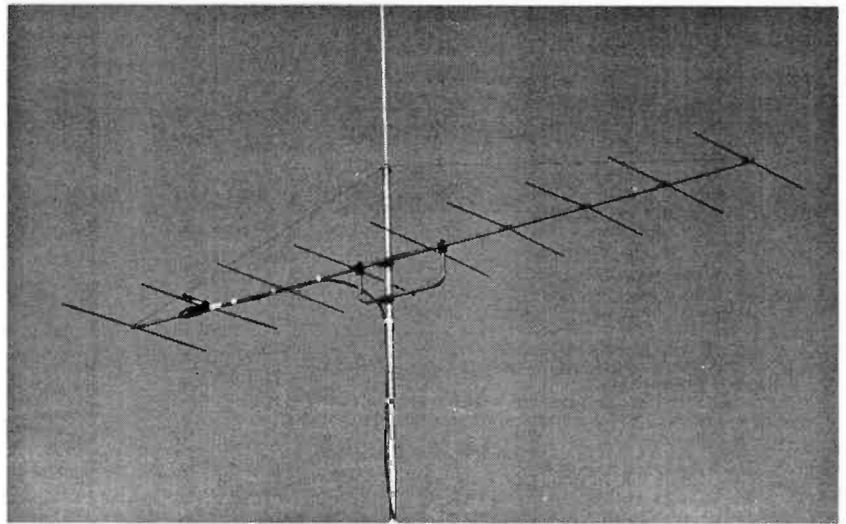

Shopping List

How Difficult?
How Much?

Beginner
about £16

To build the lightweight beam antenna you will need the following parts:
One length 3.3m x 15mm square box section aluminium. Three lengths of 10mm aluminium tubing, and seven lengths of 6mm aluminium tubing, all slightly longer than the dimensions shown in Fig. 1. You will also need one 300mm length of 13mm aluminium tubing.

One good quality variable capacitor 4-60pF.

Four plastics cable clamps 9.5mm (Electromail 543-377), a strip of soft copper 100 x 10mm x 1-2mm thick, Plastics box approx 100 x 80 x 60mm, one TV antenna mast clamp 15mm box section to 37mm round (or to suit your mast diameter).

Table 1 Element diameters and lengths

Three elements are made from 10mm diameter rod/tubing

Element	Length (mm)
Reflector	1018
Driven	972
Gamma Rod	185

The directors are all made from 6mm round rod/tubing

Element	Length (mm)
D1	945
D2	922
D3	911
D4	897
D5	878
D6	878
D7	878

When buying the various lengths ask for them few millimetres longer than the lengths given, so that you can cut them accurately to size.

Further reading

[‡] 'A Dipole Field Strength Meter' by D. J. Smillie GM4DJS, p36 *PW* February 1993. The back issue is available at £2 including P&P, from the Post Sales Department.

Electromail, PO Box 33, Corby Northants NN17 9EL. Tel: (0536) 204555

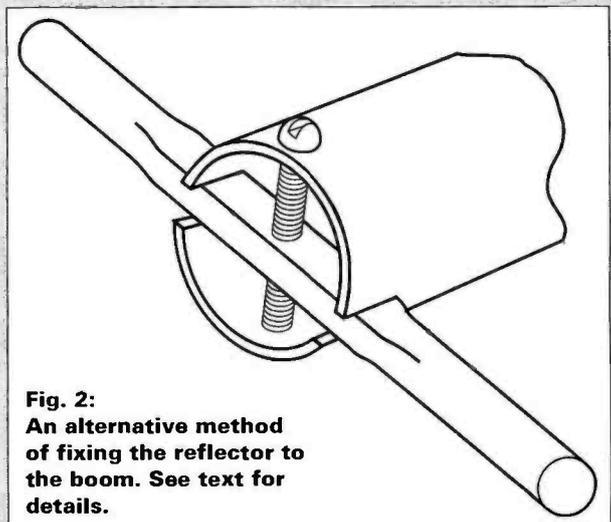

Fig. 2:
An alternative method of fixing the reflector to the boom. See text for details.

THE KITS WITH ALL THE BITS!

Guaranteed complete to the last nut!

COMPACT 80m CW QRP Tx/Rx

DTR3 Kit - £87.50 P&P £3.00 Ready Built - £140.00
 ★ Stable VFO ★ Sidetone ★ Audio Filter
 ★ Requires 12/14 VDC ★ Very detailed
 Instructions ★ Black steel case
 ★ Printed panel

40m & TOP BAND VERSIONS
 ALSO AVAILABLE

ANTENNA TUNING UNITS

TU1 Kit - £41.25 Ready Built - £57.50
 TU2 Kit - £51.00 Ready Built - £72.00
 P&P £3.00

★ Large dia. coil ★ High grade capacitor ★ Built in balun ★ Circuits to match
 your antenna ★ Up to 30 Watts of CW ★ TU2 has sensitive QRP/SWR meter
 ★ TU1 is ideal for SWL

QRP SWR METER

★ Specially designed for QRP ★ HF 1-30MHz
 ★ Can be set down to 1/2 watt for FSD
 ★ Ideal for milliwattling ★ Low insertion loss 0.2dB
 TUA1 Kit - complete with case & meter £18.00 P&P £1.00

CARLTON (Receiver)

80-40-20m Dc Rx

★ Receives USB, LSB and CW ★ Very sensitive
 and selective ★ Simple modular construction
 ★ 12-14 volt battery operated ★ Printed fascia
 Kit complete with case - £69.50 P&P £3.00

PSU 15 REGULATED POWER SUPPLY

★ Ready built ★ Mains Input ★ 13.8V @ 1.5A
 output ★ Ideal for DTR3 & 'Carlton' ★ Fully
 protected

Supplied ready built - £52.00 P&P £4.00

Send SAE for brochure or call Alan G4DVW on 0602 382509

LAKE ELECTRONICS

7 Middleton Close, Nuthall, Nottingham NG16 1BX
 (callers by appointment only)



AERIAL TECHNIQUES

11 Kent Road,
 Parkstone, Poole,
 Dorset BH12 2EH.
 Tel 0202 738232
 Fax: 0202 716951

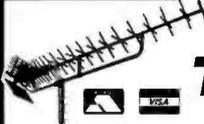

AR300XL Aerial Rotor, Control Unit and Alignment Bearing

Rotor unit type AR300XL and control console. Continuous indication of beam heading. Clamps to 2in (52mm) max. mast and take 1 1/2in (38mm) max. stub mast. 'Offset' type mounting. Vertical load carrying 45kg. Special offer £49.95 plus £4.95 p&p.

AR1201 Alignment (support) bearing. Allows greater/higher head loads. Fitted above rotor. £18.95.

Plus full range of Rexco Discones, air/marine antennas, rotators and all aerial hardware.

LATEST CATALOGUE

Send £1 for our glossy 34 page catalogue, which you will receive back by return of post.

- ★ Multi-standard TVs & VCRs
- ★ Satellite Equipment
- ★ Signal Strength Meters
- ★ TV DXing Equipment
- ★ Rotators
- ★ Masthead Amplifiers
- ★ Filters
- ★ Accessories



Q S L CARDS

Standard cards overprinted with your personal details, alternatively specials on request.

High Quality, Eyecatching Designs, Fast Turnround, Worldwide Service

Please send S.A.E. for Sample Pack

THIS MONTH'S SPECIAL OFFER

1000 QSL Cards printed from your own photograph, Overprinted with your personal details, Standard details on reverse.

FULL COLOUR £125.00
BLACK & WHITE £55.00
 inclusive

TEL: 0772 651200

BESPRINT SERVICES

Unit A71 Red Scar Industrial Estate, Longridge Road,
 Preston, Lancashire, PR2 5ND, England.

C.M.HOWES COMMUNICATIONS

TOP QUALITY HOWES KITS!

Single Band Receiver



RECEIVERS

- TRF3** Shortwave Broadcast TRF receiver for AM/SSB/CW, 5.7 to 12.8MHz. Complete electronics kit plus Hardware Pack: **£35.40**
- DcRx** Single Band SSB/CW for 160, 80, 40, 20M amateur bands or 5.45MHz HF Air. Complete kit with HA80R Hardware Pack and DCS2 "S Meter": **£48.70**
- DXR10** Three band 10, 12 & 15M SSB/CW complete kit with HA10R Hardware Pack and DCS2 "S Meter": **£58.30**

The above items are also available with assembled PCB modules, and as basic electronics kits without the hardware.

ACCESSORIES

	Kit	Assembled PCB
AP3 Automatic Speech Processor	£16.80	£24.90
DFD4 Add-on Digital Read-out for superhet radios	£49.90	£69.90
CTU30 ATU covers all HF bands + 6M for receiving or 30W TX	£39.90	£46.90
CV100 Adds Medium & Shortwave to VHF scanners	£27.50	£39.90
ST2 Morse Side-tone or practice oscillator	£9.80	£15.90
XM1 Crystal Calibrator for frequency checking	£16.90	£22.90

TRANSMITTERS

CTX 40 or 80M Band versions very popular QRP TX	£15.50	£22.90
MTX20 20M 10W CW TX - work the World!	£29.90	£39.90
AT160 Dual Band 80 & 160M AM/DSB/CW .5 to 10W PEP	£39.90	£62.90
HTX10 10 & 15M SSB/CW Exciter (matching PA etc. available)	£49.90	£79.90

AA2 150kHz to 30MHz ACTIVE ANTENNA

The HOWES AA2 is the active antenna for general coverage HF reception. Broad-band performance that does not tail off at the higher frequencies. The neat compact answer for those with limited space, holiday use, mobile operation etc. Two selectable gain settings, local or coax powering (12 to 14V). Good strong signal performance, IP3 + 38dBm. Easy to build, and much liked by customers!

AA2 Kit: **£8.90** Assembled PCB Module: **£13.90**

Mail Order to: **Eydon, Daventry, Northants NN11 6PT**
 Tel: **0327 60178**



- AA4 ACTIVE ANTENNA FOR SCANNERS**
 Covers 25 to 1300MHz. Broad-band performance in a neat, compact package. Just over 16 inches long - the answer to space/visibility problems for home or portable use. A low noise microwave IC gives good performance with a low parts count, making construction straightforward. Excellent performance in a small space!
 AA4 Kit: **£19.90** Assembled PCB Modules: **£27.90**
- AB118 AIR-BAND ACTIVE ANTENNA**
 Optimised for the VHF air-band, 118 to 137MHz. Omni-directional coverage with good low angle (long distance) reception by use of an and-fed half-wave antenna element. A low noise pre-amplifier plus band-pass filter amplifies the air-band, whilst reducing unwanted out-of-band responses. Switchable 10dB attenuator. Fits standard 1.5 inch plastic water pipe for easy weather-proof installation, or use it "naked" in the loft. Should transform your reception if you are still using that whip on the top of the scanner!
 AB118 Kit: **£18.80** Assembled PCB modules: **£25.90**

EXTRA SELECTIVITY!

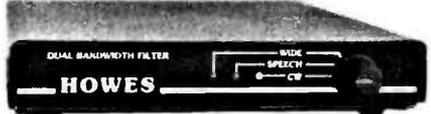

DUAL BANDWIDTH AF FILTER: £29.80

- Hot up your radio's selectivity • Sharp SSB/Speech filter with faster roll-off than IF crystal filters! • 300Hz bandwidth CW filter • Printed and punched front panel • All aluminium case • Simply connects between radio and external 'speaker' or 'phones' • Suits all general coverage receivers and transceivers • Excellent receiver upgrade!

ASL5 Filter Kit (£15.90) + HA50R Hardware (£13.90) = **£29.80**

PLEASE ADD **£1.50 P&P** for kits or **£4.00 P&P** if ordering hardware.

HOWES KITS contain good quality printed circuit boards with screen printed parts locations, full, clear instructions and all board mounted components. Sales, constructional and technical advice are available by phone during office hours. Please send an SAE for our free catalogue and specific product data sheets. We have lots more kits in the range! Delivery is normally within seven days.

73 from Dave G4KQH, Technical Manager.

Antenna Workshop

*This month in Antenna Workshop
Peter Dodd G3LDO reviews one antenna and
two antenna accessories*



The MJF-249 HF/VHF SWR Meter

The MJF-249 is the latest in a range of s.w.r. (standing wave ratio) analysers produced by MFJ. The MFJ-247, h.f. only edition, with frequency counter, was reviewed in the September 1992 issue of *PW*. With the MFJ-249, the frequency range has been extended to 170MHz.

As you may be aware, the traditional way of measuring s.w.r. is to use an s.w.r. bridge, energised by a minimum of 20W using the station transmitter. Furthermore, a conventional s.w.r. meter must be calibrated by setting the forward reading before taking the reflected reading - the actual s.w.r. figure.

The MFJ analyser is a complete instrument and does not need a transmitter. It is

automatically calibrated, so the s.w.r. reading can be read directly without calibration. I experiment with antennas quite a lot and I found this instrument a lot more useful than I thought it would be.

Usually, when I construct a new antenna and make the first s.w.r. measurements, I often find that the s.w.r. value is high within the amateur band, with a hint that the s.w.r. will

probably be low somewhere outside the band.

While it would be useful to be able to look at the s.w.r. outside the band, using a conventional set-up it would contravene the licence regulations because of the transmitted power required to measure the s.w.r.

I felt that I ought to check the MFJ-249 output power. I used a 100mW r.f. meter and the needle hardly moved off the stop. I then borrowed a sensitive 10mW meter and the output read less than 3mW, which is probably less power than a transistorised dip oscillator would couple into an antenna while measuring resonance. I then felt quite happy about using this instrument to measure s.w.r. anywhere in the h.f./v.h.f. spectrum.

In a very short time I have found the MFJ-249 to be a very useful and I have used it to:

- 1: Set the resonant counterpoises on the Diamond CP-6 h.f. vertical antenna, described in this review. I also used it to investigate how different types of mounting affected the CP-6.
- 2: Confirm the feed-point matching of a multi-band triangular antenna I am designing, over the whole h.f. spectrum.
- 3: Calibrate the station antenna matching unit on all bands.
- 4: Measure the s.w.r. of the Barker & Williamson BWD (B&W) 1.8-30 reference antenna over the whole h.f. range. If you look at the review of this antenna in the February edition of *PW*, Fig. 6 page 50, you will see that my s.w.r. measurements were restricted to the amateur radio bands because I didn't have an instrument like the MFJ-249.

This instrument covers 1.8 to 170MHz in six bands. The frequency counter enables the s.w.r. through the whole of the h.f./v.h.f. range to be measured at precise frequencies. Additionally, the frequency

counter can be used in its own right for frequency measurement.

The price of the MJF-249 is £229 (£3 P&P) from Waters & Stanton Electronics, 22 Main Road, Hockley, Essex SS5 4QS. Tel: (0702) 206835. This may seem a rather high price to measure s.w.r. conveniently, but if you consider that it is also a frequency counter with a liquid crystal display, it puts the value into proper perspective.

Diamond CP-6 HF Vertical Antenna

The Diamond CP-6 HF Vertical antenna is a new derivative of the earlier CP-4 and CP-5. It is a 5- or 6-band system comprising a vertical radiator and five or six individual counterpoise elements, one for each band, so the antenna does not require a separate counterpoise system. There are only three traps in the vertical element; one of them is a dual unit. The maximum power rating is 200W p.e.p.

The vertical element is pre-tuned to the centre of each band

The H frame magmount from Tennamast

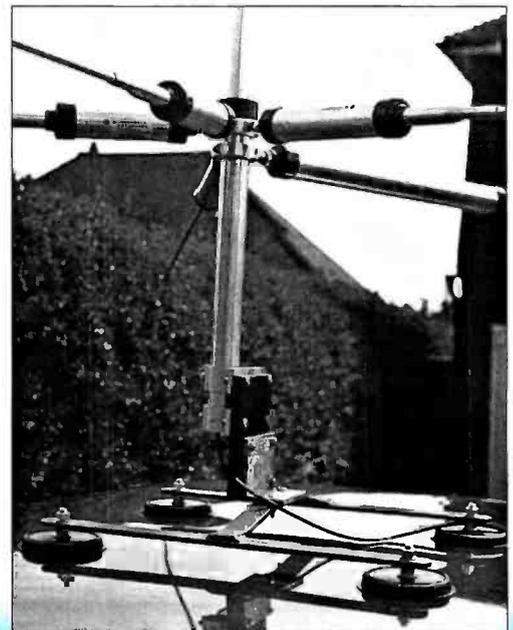

and the final resonant frequency adjustment is carried out on the counterpoise elements. The instructions are partly in Japanese, although the assembly diagram does give sufficient information to assemble the antenna. A separate sheet of general advice is supplied by the importers, Waters & Stanton.

Assembly of the antenna is fairly straightforward, but it is important to read all the instructions before commencing. One of the most important points is the location of the antenna. I didn't read the instructions in enough depth and missed the essential point regarding antenna location.

I mounted the Diamond on my fold-over mast so that it was vertical when the main mast was folded over. When the antenna is installed this way, the mass of metalwork takes over as the counterpoise and the tuneable ones on the antenna itself are ineffective. The antenna still worked but it wasn't possible to adjust the resonant point.

Normally, the antenna must be installed on a pole at least a metre long. However, having said that, it is possible to mount the antenna close to a metal structure if the base is insulated from the structure.

The conditions were rather poor during the period I tested this antenna on the air. Nevertheless, a number of comparative test results were obtained.

The reference antenna was the B&W 1.8-30 broadband dipole reviewed in the February *PW*. It is installed in an inverted V configuration, with the apex of the inverted V 10 metres high.

DX stations were contacted on all bands except 50MHz (6m); I don't have any equipment for that band. The openings on 28MHz (10m) were mostly confined to Sporadic-E. These signals were very strong

on the Diamond and were, on average, half an S-point up on the B&W 1.8-30.

I think this antenna is ideal for someone who has little or no garden to put up a conventional dipole or even a larger vertical with radials. It could also be useful for portable work or be used from a caravan when on holiday. It is 4.5 metres long so, I don't think it has any more visual impact than a CB antenna. The radial element lengths are approximately 1.8 metres.

The price of the Diamond CP-6 is £279 (£6 P&P) from Waters & Stanton Electronics, 22 Main Road, Hockley, Essex SS5 4QS. Tel: (0702) 206835.

Magnetic Clamp

Modern cars are not very user friendly to the h.f. mobile radio operator.

There is very little room to put the rig, and no bumpers suitable for mounting the antenna. If you are a dedicated h.f. mobile operator then, of course, you can fix a special antenna mount as described in the March 1993 edition of 'Antenna Workshop'.

If you don't want to drill holes in your car then you could use a magmount. Many magmounts wouldn't hold a $5\lambda/8$ 144MHz vertical at speed let alone a 3.5MHz loaded whip.

Tennamast have come up with a solution. It comprises an H frame with four very powerful magnets that will hold any h.f. mobile antenna to a metal roof of a car.

The magmount comes as a kit, with the complete frame, magnet cups, magnets and nuts and bolts. The frame is finished with a red lead type primer; you

then finish it in the colour of your choice. I left mine as it was, because it already matched the colour of my car (no it isn't rusty, it is just painted that colour). All you have to do is fix the magnets to the frame with the nuts and bolts provided. A plastics disc and a rubber boot are used to cover each of the four magnets to protect the surface of the car.

This magmount really clings to the roof like a limpet. It poses problems of getting it on to the roof and then getting it off again. The best method is to lower it on to the roof of the car at an angle so that the two magnets furthest from you come in contact with the car. When you have decided that the position is right then lower the

side of the frame closest to you. If you have to move or remove the magmount then you will have to lift the frame nearest to you to pry magnets from the roof of the car.

What is the largest antenna the clamp will support? I tried mounting the Diamond CP-6 HF, described earlier, on my car roof, which is much larger than any mobile antenna. While is impractical to drive with an antenna like this on the car it can still be used for that contradiction in terms, 'fixed mobile'.

My thanks go to Tennamast (Scotland), 81 Mains Road, Beith, Ayrshire KA15 2HT. Tel: (05055) 3824 for the review magmount, which costs £25 (£5 P&P).

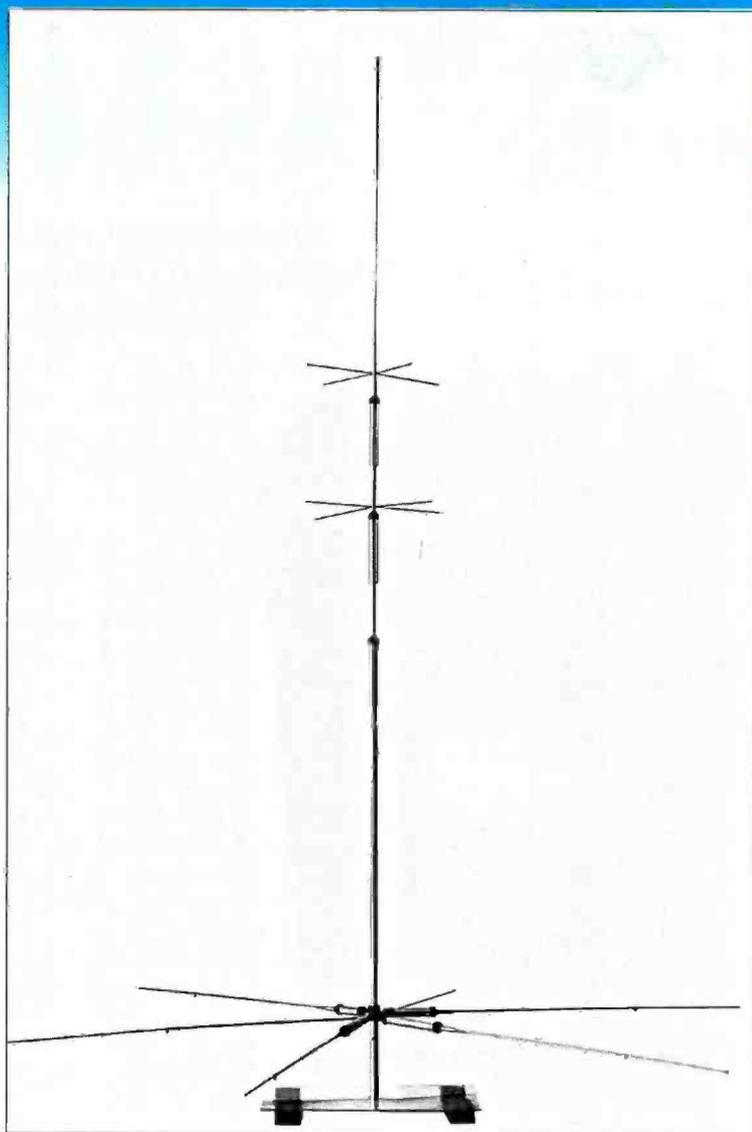

The Diamond CP-6 HF Vertical Antenna.

BOOK REVIEWS

THE ARRL ANTENNA COMPENDIUM (Volume 3)

Editor Gerald L. (Jerry) Hall K1TD

Published by The American Radio Relay League

236 pages, 208 x 276mm, £9.50. Available from PW Book Service, (£1.00 P&P UK, £1.75 P&P overseas).

ISBN 0-87259-401-7.

Here's a wonderful selection of forty antenna related projects for the enthusiast. The book avoids the mundane and introduces a range of fascinating new antenna designs. Each of the projects is extremely well documented with full supporting theory, where appropriate. The range of designs is excellent and includes such diverse topics as a d.f. unit through to a 16- x 14-element 432MHz e.m.e. array! There is also a

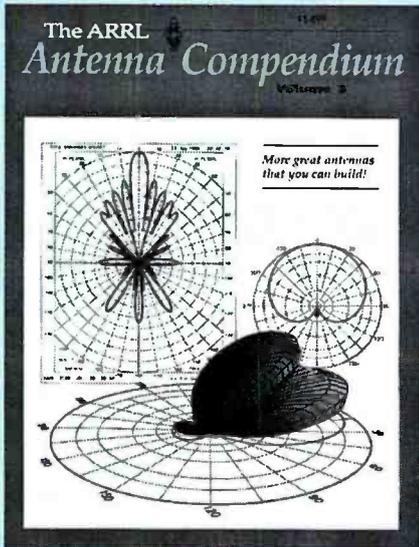

strong accent on the use of computer modelling to design and refine antenna systems. A number of computer programs are listed in the book and a disk is available from the ARRL for those without the patience to enter the programs themselves. In addition to the antenna designs, there are a number of technical features covering test and measurement, impedance matching and propagation.

BEAM ANTENNA HANDBOOK

by William I. Orr, W6SAI and Stuart D. Cowan, W2LX

Published by Radio Publications Inc.

268 pages, 134 x 213mm, £7.50. Available from the PW Book Service, (£1.00 P&P UK, £1.75 P&P overseas).

ISBN 0-933616-10-4.

Most keen h.f. operators long for the ultimate beam antenna to pull in that elusive DX station or cut through a 14MHz pile-up. The *Beam Antenna Handbook* has been designed to provide a practical guide for the operator who wants to build his or her own system. Complex formulae have been minimised by the use of computer aided design parameters. This results in the extensive use of tables for antennas dimensions. All the measurements are given in both imperial and metric units so old and young alike should be happy! Being of American origin it's not surprising to find that there are one or two massive antenna systems included. One of the illustrations shows a 6-element 14MHz beam being lowered onto a tower by a tethered hot air balloon! However, the bulk of the book concentrates on good designs that can be built by anyone with moderate mechanical skills.

THE RADIO AMATEUR ANTENNA HANDBOOK

by William I. Orr, W6SAI and Stuart D. Cowan, W2LX

Published by Radio Amateur Callbook

187 pages, 137 x 214mm, £7.50. Available from the PW Book Service, (£1.00 P&P UK, £1.75 P&P overseas).

ISBN 0-8230-8706-9.

Following the down-to-earth practical style of the other books from Orr and Cowan, *The Radio Amateur Antenna Handbook* encompasses all aspects of antennas. The coverage starts with a sound introduction to some of the antenna basics with a particular accent on DX antennas. Throughout the book the use of complex formulae is kept to a minimum to ease understanding. In addition to full coverage of a wide range of antenna types, a full chapter is dedicated to performance and the s.w.r. meter. This chapter goes a long way to clarifying many of the myths surrounding antenna performance. There is even a chapter dedicated to towers and rotators which contains lots of sound advice.

ALL ABOUT VERTICAL ANTENNAS

by William I. Orr, W6SAI and Stuart D. Cowan, W2LX

Published by Radio Amateur Callbook

191 pages, 137 x 214mm, £7.50. Available from the PW Book Service, (£1.00 P&P UK, £1.75 P&P overseas).

ISBN 0-8230-8710-7.

This wonderfully practical book leads the reader carefully through the construction of a wide range of vertical antennas. This is very much a book for those that want to build antennas as opposed to just learning the theory. Whilst the first couple of chapters explain the operation and the importance of a good ground system, the book moves swiftly into useful antenna designs. Although the accent is on h.f. antenna systems, there are a few designs for v.h.f. systems. *All About Vertical Antennas* makes excellent use of diagrams and photographs to illustrate the constructional techniques. For most of the designs, the formulae has been reduced to close approximations and look-up tables. This makes it very easy for the reader to adapt the designs for other frequencies.

PRACTICAL ANTENNA HANDBOOK

by Joseph J. Carr

published by TAB Books

439 pages, 188 x 233mm, £20.95. Available from PW Book Service, (£1.00 P&P UK, £1.75 P&P overseas).

ISBN 0-8306-9270-3.

This comprehensive book aims to equip the experimenter to be able to design, build and modify antennas with confidence. The range covered extends from h.f. right through to microwave frequencies. The first section of the book provides a comprehensive tutorial on the theory of antenna operation. In this section, a strong emphasis is placed on the importance of the Smith chart and there are lots of examples of how to use it. The book makes progress through the various antenna systems at a good pace, giving the reader a sound introduction to the basics. The book packs in a remarkable number of antenna designs, each with the formula required to build practical examples. The final chapters provide some useful reference material, including a number of BASIC computer programs to help with antenna design and use.

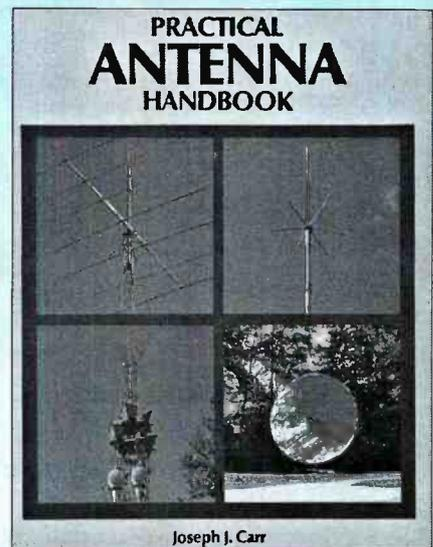

Joseph J. Carr

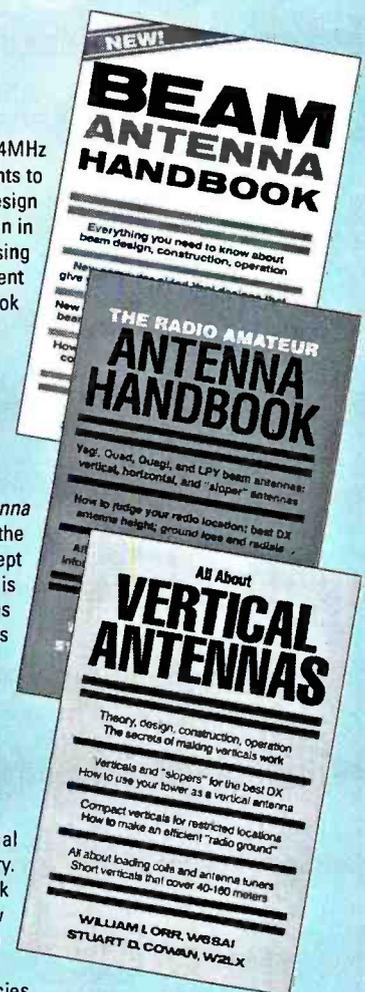

The Computer
in Your Shack

BITS & BYTES

This month, Peter Hunter GOGSZ poses a question to readers, and then looks at interesting CD-ROMs with some very interesting software.

Welcome to the column that's aimed at helping you get the best out of amateur radio with your computer. This month, I'm starting with a request from Steve VK3CAX. He's got an 'old' BBCB, and uses KERMIT (a comms program) for packet radio.

If you have ANY software for the BBC model B (especially a packet program) then Steve will be glad to hear from you. You can contact him via packet: VK3CAX @ VK3IBM.VIC.AUS.OC or via me.

Control Program

The TRANSCAN is a PC-based computer control program for the ICOM 7100

receiver. I don't have an IC-7100, so if you want more information contact Mike Ward of MIDAC SYSTEMS, 33 Cannon Leys, Galleywood, Chelmsford, Essex. CM2 8PB, tel: (0245) 74554.

Next, there's Kentrol For Windows. This is a KENwood control program that lets you 'drive' your Kenwood from within Windows.

The Kentrol program for Windows is shareware, written by Brian Gilhuly VE3BGB. You can contact Brian direct at: 490 Concord Avenue, Toronto, ON, M6H 2P8, Canada or send me a formatted (PC) 3.5in disk, plus return postage, etc. for a trial copy.



Fig. 1: The Mitsumi CD-ROM drive kit.

technology, I've been taking an interest in CD-ROM (Compact Disc - Read Only Memory) drives and software. This technology has been beyond the pocket of the enthusiast, until, that is, the introduction of the Mitsumi CRMC-LU005S.

The Mitsumi CRMC-LU005S is a 'budget priced' internal CD-ROM drive, and Fig.1 shows what you get for your money. The Interface is built onto a standard 16-bit card, and plugs into a vacant 16-bit (ISA) slot.

The drive is fitted into any free 5.25in half-height horizontal drive bay. Fitting takes about 15 minutes work in all, installing the software is easy and takes about five minutes, making a total 20 minutes from unpacking to using. The photograph, Fig.2, shows the drive fitted and Fig.3 shows a CD-ROM disk being inserted.

There is a headphone socket and volume control on the front panel, and the interface card has two speaker sockets. It can also be connected to a sound card.

I plugged a pair of amplified speakers into the front headphone socket, this worked extremely well. The CRMC-LU005S is compatible with standard music CDs, so you can listen to Mozart whilst 'playing' packet!

Lots Of ROMS

You may be wondering 'What about CD-ROMs?'

Well, there are already lots of these ROMs available, and the list is growing fast. In fact, PDSL has recently put almost their entire library onto ONE CD-ROM, called the Libris Britannia, pictured in Fig.4.

The Libris Britannia disc contains over 2000 volumes of a 'standard' 360K floppy. A total of 650 MEGABYTES of software!

Of special interest to radio amateur's will be the 'Ham Radio' ROM in Fig.3. This CD contains over 200Mbyte of ONLY amateur radio related software.

The Mitsumi drive is available from ADD (UK) Ltd. Braehead, Stonehaven, Scotland, AB3 2XJ, tel: (0569) 63003. Current price is £189 including P&P plus VAT, and this includes two CDs full of shareware.

Libris Britannia is from: PDSL, Winscombe House, Beacon Rd, Crowborough, Sussex, tel: (0892) 663298. Price is £49, inclusive of P&P, plus VAT.

The Ham Radio software v 3.0 from UNICA Ltd., tel: 061-429 0241 and ask for their catalogue. Ham Radio costs £19 including P&P, plus VAT.

And that's about it for this month. Keep writing, I'm looking forward to your letters, 73 de Peter GOGSZ. QTHR or @ GB7LDI. Tel/FAX: (0603) 748338 or to 2 Mayes Close, Bowthorpe, Norwich, Norfolk NR5 9AR.

E N D

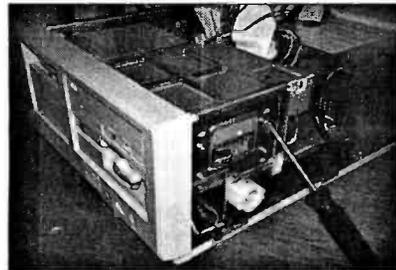

Fig. 2: The CD-ROM drive fitted in to Peter Hunter's computer.



Fig. 3: The CD-ROM drive's 'door' open with disc in place.



Fig. 4: The Libris Britannia CD-ROM disc from PDSL (see text).

A Question

Now, I've got a question for 'Bits & Bytes' readers! As Windows has been around for some time now, just where is all the amateur radio software for Windows?."

Firstly, I should say that there are some first class programs available. The LAN-LINK, SHACKLOG and SUPER-DUPER software is proof of that. So how about some versions for Windows? Let's be hearing from you, I'm eager to try your programs!

Compact Disc Memory

In my quest to keep up-to-date with

J. BIRKETT

SUPPLIERS OF ELECTRONIC COMPONENTS

25 The Strait
Lincoln, LN2 1JF
Tel: 520767
Partners J.H. Birkett
J.L. Birkett

6 HOLE FERRITE BEADS @ 8 for £1. SUB-MIN FERRITE BEADS @ 12 for 50p.
2 HOLE FERRITE BLOCK @ 25p. LARGE 2 HOLE FERRITE BLOCK @ 60p.
L.F. CHOKES 47mH @ 3 for £1. R.F. CHOKE 7.5mH 100mA @ 75p. 10mH 100mA @ 75p.
4 1/2" 240 VOLT AC MAINS FANS @ £4.95 Pair (P. & P. £1.50).
ASTEC TUNER TYPE UM1181 No. info @ £4.95.
200MHz DUAL GATE MOS FET BF981 @ 35p each, 4 for £1.20.
MULLARD DC171 @ 95p, 4 for £3.40.
R.F. POWER TRANSISTORS PT9788 2 to 30MHz 24 volt 20 watt SSB matched pair £12.95.
AIRSPACED VARIABLE CAPACITORS with X spindle each end 365 + 365 + 365pf @ £4.95, 75pf @ £4.95, 100pf @ £4.95.
MURATA CERAMIC FILTERS 455kHz @ 6 for £1, 10.7MHz @ £2.50, Out of Spec. 18GHz GaAs FETS @ 3 for £2.00.
GaAs FETS Black Spot 18GHz @ £1.85, Red Spot 24 GHz @ £2.30, Out of Spec. 18GHz GaAs FETS @ 3 for £2.00.
SE1 CRYSTAL FILTERS 10.7MHz Type QC1246MIB @ £3.95, 1121A 10.7MHz @ £2.95, TOYCOOM 10.7MHz T14F014M @ £2.95, 68.545MHz @ £2.50.
COCIL CRYSTAL OSCILLATOR 5.6MHz with data @ £1.50, HIGH Q SSB 1.4MHz 2.4kHz QF01448 @ £2.95.
SBL1 BALANCED MIXERS @ £3.95 each, TOKO 10.7MHz I.F. TRANS. type KACS8184 @ 35p each, 4 for £1.20.
CRIMP ON N TYPE COAX PLUGS @ 60p, 4 for £2.00.
RESISTORS 470hm 25 watt Wire Wound alloy housed @ 3 for £1.00.
HIGH POWER ZENER DIODES BZY93-9V1 20 watt @ 80p, BZY93-C10 20 watt @ 80p, BZY93-C11 20 watt @ 80p, DIODES 150pV 15amp @ 50p, AA119 @ 15p.
C904 TYPE AIR SPACED VARIABLE CAPACITORS 10pf, 25p, 50p, 100pf All @ £4.95 each.
PHILLIPS ELECTROLYTICS 10,000uf 40v.w. @ 60p, 4 for £2.00.

ACCESS, SWITCH and BARCLAY CARDS accepted. P&P 60p under £5. Over Free. Unless otherwise stated.
C.M. HOWES KITS. Available by post and for callers.

SOLAR PANELS

Special offer: 12" x 6" 12v 80mA Asi pre-wired panels.
1 - £4.50 5 - £18.00 + £1.50 P&P per order

Info sheets - 2 x 1st class stamps

Many other sizes/output panels available. Orders/info from:
Wind generators 25-250W. R. KEYES, KEY SOLAR SYSTEMS,
Solar Chargers made to your specifications 4 GLANMOR CRESCENT,
All standard sizes in stock. NEWPORT, GWENT NP9 8AX.

SUREDATA

AMSTRAD REPAIRS AND SECOND USER SALES

Tel/Fax: 081-902 5218
Second User HOTLINE
0831 616519 (after hours)

SECOND USER EQUIPMENT Prices have dropped yet again so I am now offering starter systems from as little as £100 (at this rate the delivery will soon cost more than the computer). Now is an ideal time to get in to packet radio or get a second PC for the kids.

UPGRADES Our very popular 3.5" disk drive upgrade kits for PCW 8256/8512/9512 and PC1512/1640 are still available. A phone call will get you advice and a price.

REPAIRS Phone for a diagnosis and estimate. 73's John G3TLU

UNIT 5, STANLEY HOUSE, STANLEY AVENUE, WEMBLEY, MIDDX HA0 4JB

GOLD SEAL BP GARAGE

95 Colindeep Lane, Sprowston, Norwich, Norfolk NR7 8EQ.
Open Mon - Sat 9.30 - 5.30

NORTH WALSHAM RD
B1150

EDWARDS RD

SHOP OPEN
MON-SAT 9.30-5.30

TEL: OR FAX: 0603 788281

"PHONE US NOW FOR BEST PRICES"



THE SHORT WAVE CENTRE NORWICH

Do you need a scanner or receiver?
Do you need amateur radio equipment?

"Kenwood, Icom, Yaesu, Alinco, Yupiter, Aor etc"
But most of all do you need equipment serviced?
We have up to date test equipment, fully equipped workshop for all types of radio equipment.
Second Hand Equipment Available, Part Exchange Welcome.

Quantek Electronics

<h3>FAIRMATE HP2000</h3> <ul style="list-style-type: none"> ★ 500kHz - 1300MHz ★ 1000 channels ★ NFM/WFM/AM ★ Supplied with: Ni-cad batteries, UK charger, 2 antennas, carrycase, earphone, DC cable, belt clip and strap <p>SPECIAL OFFER £phone</p>	<h3>YUPITERU MVT7000</h3> <ul style="list-style-type: none"> ★ 8kHz - 1300MHz ★ 200 channels ★ NFM/WFM/AM ★ Signal strength meter ★ Supplied with: Ni-cad batteries, UK charger, antenna, DC power lead and carry strap <p>SPECIAL OFFER £phone</p>
<h3>AOR 1500EX</h3> <ul style="list-style-type: none"> ★ 500kHz - 1300MHz ★ 1000 channels ★ NFM/WFM/AM/SSB ★ Supplied with: Ni-cad batteries, UK charger, antenna, LW antenna, dry cell battery case, soft case, earpiece <p>SPECIAL OFFER £phone</p>	<h3>YUPITERU MVT7100</h3> <ul style="list-style-type: none"> ★ 530kHz - 1650MHz ★ 1000 channels ★ NFM/WFM/AM/LSB/USB ★ Supplied with: Ni-cad batteries, UK charger, antenna, DC cigar lead, carrying strap, belt clip and earphone <p>SPECIAL OFFER £phone</p>
<h3>OPTO ELECTRONICS 2300</h3> <p>Frequency counter/finder. An extremely sensitive hand-held frequency counter. It will display the frequency of a 2 watt transmitter at 100ft!</p> <ul style="list-style-type: none"> ★ 1MHz - 2.4GHz ★ Fast/slow gate times ★ Hold switch ★ Supplied with: Ni-cad batteries, UK charger and antenna <p>£149</p>	<h3>SCANNER AUTO-VOX</h3> <p>Connects to and works with any receiver which has an 'ear' socket and squelch control. Simply plug the AUTO-VOX into the 'ear' socket of the receiver, then plug the output leads from the AUTO-VOX into the microphone and remote sockets of a tape recorder. The AUTO-VOX will then automatically switch the tape recorder on when a signal is received and off when there is no signal present - result a tape full of all the action!</p> <p>Scanner AUTO-VOX £24.95</p>

ALL PRICES INCLUDE FREE P&P (UK ONLY)

Quantek Electronics
3 Houldey Road, Birmingham, B31 3HL

OPENING HOURS
Monday - Friday
9:00am - 5:30pm

ALL PRODUCTS GUARANTEED FOR 12 MONTHS

Tel: 021 411 1821 • Fax: 021 411 2355

DEWSBURY ELECTRONICS

Professional-grade, high performance data communications decoder/analyser, yet easy to use and at an affordable price:

- ★ Decodes Morse code, standard baudot, bit-inversion, arq, fec, ASCII, packet radio and variable speed baudot and ASCII.
- ★ For professional users, 14 additional commercial data communications modes (on supplementary eeproms) are available.
- ★ Measures baud rates with high accuracy and makes synchronous and asynchronous bit analysis.
- ★ LED-bar indication for tuning.
- ★ Hard- and software additions and upgrade capabilities.
- ★ Built-in f7-b (f8) decoder.
- ★ Universal microprocessor video card (24 lines x 80 characters or 18 lines x 40 characters).
- ★ Extensive rfi-filtering on all lines.
- ★ 5 int. language sets, including Cyrillic and Greek.
- ★ RS-232C/v. 24 serial port, Centronics parallel port.
- ★ Optimal customer's support due to in-home r+d and 1 year warranty.

PRICES FROM £1110.00 inc. VAT.
For details of this and other decoders please send an s.a.e.

wavecom W 4010

NOW AVAILABLE - VERSION 5



DEWSBURY ELECTRONICS,
176 LOWER HIGH STREET,
STOURBRIDGE,
WEST MIDLANDS DY8 1TG

Tel: (0384) 390063
Fax: (0384) 371228

Instant finance available subject to status.
Written details on request.

Ron Ham opens the *PW* vintage wireless shop once again to look at your letters, fault finding problems and restoring military equipment.

Valve &

This month I'm starting off with an interesting letter: "I've collected a fair number of radios over the years and my interest is in restoring them to full working order," so wrote **Doug Howat** (Bristol). He added: "To be fair, I do the electrics and someone else does the woodwork."

That sounds a very good arrangement to me Doug, each to his own expertise! However, Doug asks, "what do other people **DO** with them after they've been restored?" Apparently, Doug once mounted an exhibition at a local building society, but after setting up the display he was totally exhausted. I'm not a bit surprised Doug! Joan and I had our fair share of that before I found a permanent home for my collection.

To put on the show, Doug delivered four car loads of sets. He had to carry them down two flights of stairs, load and unload them from his car and hump them up another flight of stairs at the society end. Of course he was exhausted, he shifted at least half a ton of gear!

On Display

I think that vintage wireless sets, restored or not, should go on display somewhere for people to see. After all, they are an important part of the technical and social history of this century. Just think, what would life have been like without wireless?

In the early 1970s, I was writing

for *Communications International* and *Electronics Weekly*. In 1975, *CI* had a stand at a Telecommunications Exhibition in Brighton. As it was on the South-coast and near to the anniversary of 'D-day' (June 6th), the Editor wanted a small display of wartime sets on the stand, photographed in **Fig. 1**.

The display in the photograph included, (left to right) the R1155/T1154, HRO, WS18 and 19, and, behind the '19', a transmitter (SK-2), **Fig. 2**, and receiver (EK). **Fig. 3**, from a German bomber. We had no idea what was to come from this three day exhibition to reward our 'humping' and organising.

Firstly, the sets caused great interest among the service, ex-service and civilian visitors alike. Secondly, a report and a picture about it appeared in *The Financial Times* and later, a half page and picture was devoted to my whole collection in *The Times* newspaper.

Finally and what always pleases me most, the exhibition gave great pleasure to a lot of people. Former soldiers and airmen shared memories of how they used this gear in anger, and there were times when the *CI* stand had a fascinated audience.

Storrington Library

During the 1970s we demonstrated some early Marconi equipment to the local press. In 1976 we installed an



Fig. 1: Wartime sets as displayed on the 1975 *Communications International* stand.

exhibition in Storrington library, about communications and covering two world-wars. The librarian backed it up with books on the subject and three local papers, plus BBC Radio Brighton, gave it good coverage.

The County Librarian requested the display to be moved to the libraries in Pulborough and Steyning. Then, Horsham and Worthing museums each had the entire collection, in a dedicated exhibition room, for about five weeks. Later, a selection, **Fig. 4**, went to the Cornwall Aircraft Park in Helston for six months before I donated it all to The Amberley Chalk Pits Museum, where it can be seen to this day.

In The Loft

After each exhibition, press report or broadcast there came offers of more goodies, as people were reminded that granny's old set was still in the

loft. However, it's impossible to keep all that's offered, although there were times when an item was so rare that it could not be refused.

For instance, one day a chap spotted me, stopped his car and offered me 'the old telly in the back'. I was as pleased to have it as he was to unload it, because this large highly polished cabinet was a 1936 Marconi television with a viewing mirror in the lid!

I arrived home one day and found an immaculate Gec-O-Phone, No. 2, crystal set on my coal bunker with a note saying "dump this if you don't want it". Both of these sets can now be seen in the Amberley museum.

So, ask at your local public library, museum, technical college or school to see if they would like a display on a temporary or permanent basis. Remember, that vintage set that you have lovingly restored has an educational value.

Perhaps more than half a century has elapsed since your vintage set was manufactured, packed, despatched and distributed through the wholesale and/or retail trade. When sold, it no doubt had pride of place in a living room and was someone's main source of news and entertainment.

Cape Town Ferguson

During a trip around the second-hand shops in Cape Town, South African reader **Nick Price** found a domestic set, model 361XL, made by Ferguson, **Fig. 5**. Perhaps you too can remember their hoarding advert readers. They featured a thoughtful looking gent, in an armchair, saying "Fine sets these Fergusons".

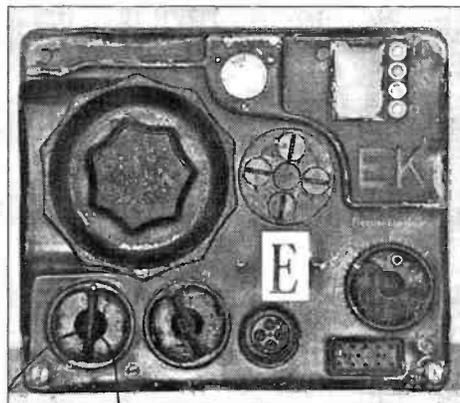

Fig. 3: The FK receiver from a German bomber.

Fig. 2: The Sk-2 transmitter.

Vintage

By Ron Ham

This set looks fine Nick, but I can't find any reference to it in the volumes of *Radio And Television Servicing*. I've handled many sets of this typically British style, but judging by the eight wave-bands on the dial, it was most likely an export only model.

Problem is readers, Nick can't locate a wave-change switch knob to complete his renovation. So, if anyone can help, please drop him a line at 67 Bordeaux, PO Box 609, Kuils River 7580, Cape Town, South Africa.

The B40 Receiver

Do you have an ex-Navy 'B40' communications receiver for sale, or know the whereabouts of one? If so, please contact Mr. I. Simpson, 132 Park Rd, Portadown, Craigavon, County Armagh, Northern Ireland, BT62 1BH.

Mr Simpson says, "I get great satisfaction from restoring ex-military equipment to their former glory". I agree with him, because we'll never see the like of that technology again.

Apart from its weight, my main memories of the B40 are the chain driven dial mechanism and the massive great turret tuner. I think it was made in the late forties/early fifties to replace the Navy's h.f. receiver known as the CR100. There was also a look-alike, the 'B41', which worked in the v.l.f. part of the spectrum.

Although it's many years since I repaired a 'B40', I remember that there were calibration 'spots' at various points on each wave-band on the dial. I believe, at these points, the operator can switch on the internal crystal calibrator and adjust the 'spot', mechanically, to the crystal tone with a lever on the 'lighthouse' type dial.

Hallicrafters Equipment

My thanks go to A. F. Sephton (Shepherds Bush) for telling me that manuals for Hallicrafters equipment can be obtained from Ardc Electronics, PO Box 95, Dept Q,

Berwyn, Illinois, 60402, USA.

Hallicrafters enthusiast, Brook Verral (London) is progressing with rebuilding a Super Skyrider (SX28). He bought a complete (photocopied) manual from the Vintage Wireless Company in Mangotsfield, Bristol. If you're working on an SX28, write with an s.a.e. to: 17 Hadley Hall, Lynwood Grove, Winchmore Hill, London, N21 3JP.

Thanks to the kindness of Tony Harwood G4HHZ (Chandlers Ford, Hampshire) and Richard Williams (Deddington, Oxfordshire), Graham Canning and myself now have a circuit and manual for the Hallicrafters S20 and S20R.

Incidentally, among the vintage receivers that Tony G4HHZ has in regular use are an Eddystone 'All World 2' and 'All World 4', Hallicrafters SX24 and SX28 and a Peto Scott t.r.f. receiver.

Philco Receiver

"I was recently given a Philco Model 582 receiver," so S. Jones (Handsworth) tells me. It wasn't working, but he traced the fault to a 0.2µF capacitor, associated with the tone control circuit. This had shorted and, consequently, 'fried' the control.

He then found problems with reception. The short wave band is okay, but, apart from BBC Radio 4 on the long wave, nothing else can be heard on this or the medium wave band. Mr Jones wonders if a large antenna would solve the problem.

I don't think a large antenna would help. A set that insensitive, especially with today's strong broadcast signals, can't be working efficiently.

Unfortunately, Mr Jones receiver's trouble could be almost anywhere. So I'll try to help by thinking aloud!

You say the short wave band is working OK, so that rules out the i.f., detector and audio stages. One strong signal (BBC Radio 4) on the long wave, coupled with a working short wave, suggests that the frequency changer stage is working. My thoughts keep turning toward the local oscillator and it's alignment on these two bands.

Fig. 4: Early Marconi equipment on display at the Cornwall Aircraft Park, Helston.

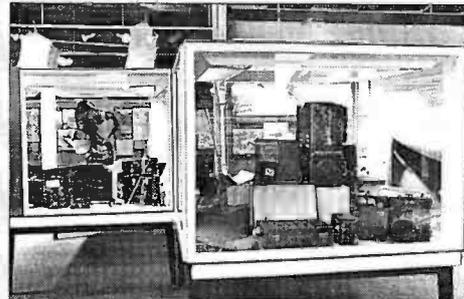

If the signal from the l.o. was above, instead of below, or vice versa, of the frequency of the incoming signal then such symptoms could appear. Depending on the design, the frequency of the l.o. in a superhet, could be the amount of the i.f. either side of the incoming signal.

Now, let's suppose a capacitor in the oscillator stage was open or short circuit, or the trimmers were wrongly set and a weaker oscillator signal was coming out. Then it's likely that only the strongest signal, like BBC Radio 4, would get through the system. You really need a signal generator to prove faults of this type. Make sure that the wave-change switch contacts are clean and engaging properly and if a local/distant switch is fitted see that it's set correctly.

The 19 Set

"Where and what should I look for". That was the question from Mark Sutton (Mansfield, Nottinghamshire) who wants to add an ex-army WS19 to his collection of valved equipment.

Briefly Mark, there were two general types of 19 set which were often described as the British and the Canadian versions. Both were designed for use in armoured-cars and tanks.

The Canadian version was built in secret, and shipped to the UK ready for use during the Allied invasion of Europe which began in on June 6, 1944. The dials on the Canadian set were scribed in both English and Russian. This model, I think it was the Mark III, was fitted with a 'B' set which was a small low-power v.h.f. transceiver working around 235MHz.

A WS19 set is large and heavy and requires a great deal of power to drive it. Throughout the 1950s these sets, complete with rotary transformer power unit, antenna variometer, large multiway screened connecting leads and the user accessories were sold for a few £s. But now, 50 years later, they are collectors items and are fetching high prices.

If you do find one complete in original condition, apart from a good clean up, personally, that's how I would leave it. By now most, if not all, the small capacitors would need replacing and, no doubt, many of the resistors would have changed value.

You could replace this lot with new parts and clear some other faults resulting from damp storage. But what's left, is certainly not an example of some manufactured in the Second World War. So, think carefully before you spend that hard-earned cash.

Cheerio for now, and I'm looking forward to opening the V&V 'wireless shop' next time. But you can write to me any time at: 'Faraday', Greyfriars, Storrington, West Sussex RH20 4HE.

Fig. 5: Nick Price's Ferguson 361XL

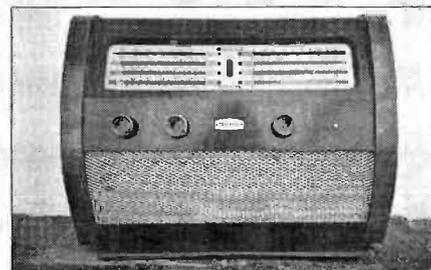

This month, Paul Essery GW3KFE starts off with a useful tip, brings you the latest up-date on h.f. bands activities, and provides some sound advice on the way.

Report

S
BANDS
B
H F

Some people love DX nets, while others think they are the utter pits. I'm neutral. I generally prefer to raise the stuff for myself.

However, if you join a net and abide by the rules, you can often gain a better idea of how your own signal compares with the locals. If they all get 5-9 reports and you get 5-4, in a DX net either: Something is wrong with the rig, or you're under a handicap.

In the latter case, you alone can say whether you can mitigate the handicap, or must live with it. Of course, you must average out over several sessions for a reliable results. Looking back now, band conditions have been up and down. But the sunspot count is definitely lower and summer conditions don't help!

As regards contests the 'close season' is on us for the 'big 'uns'. But never forget that it's these big contests that can fill up the gaps in your countries score.

John G3BDQ noted my call isn't in the current **UK Call Book**. Last year, it took about three months for SSL at Bristol to sort themselves out, so for that time I was on the print-out as not renewed.

Eventually this was resolved. However, this year I received no reminder, so sent off a photocopy of my validation document, letter and cheque recorded delivery to SSL. A week later the lot came back having been received opened and returned by a different company! You just can't win!

New Antenna

Still with John G3BDQ, I hear that he's been playing around with a new all-band antenna design for 1.8 to 28MHz using a 27m top only. On 1.8MHz it shows marked promise, and on 21MHz shows two S-points gain over a rotary dipole.

A GJ worked on 28MHz sums conditions there up (!),

while 21MHz was quite poor to the west, but yielded an all-time new one by way of V85BJ in Brunei. There were VKs on 14MHz, and JA and 3B8FG on 18MHz. John G3BDQ, is in Hastings by the way.

Between ill-health and gardening, not to mention summer static, **G2HKU** hasn't been too active. Ted runs an Omni-V and QRP from an IC-721S; outside he has G5RV and HF6 antennas.

The IC-721S and G5RV gobbled-up ZA1Z, while a switch to the Omni-V yielded BV4CT, Y19CW and VS6WV. His 18MHz activity netted National Library Day celebrations with 7Q7XX, VB1YX and JM6NOR. On 21MHz and HF6 antenna HL4CIS on the Omni-V and 9H3JR on the Icom rig were hooked. As for 28MHz, a turn-up for the book was 4L1WL who turned out to be in Tbilisi! All, of course, were worked on c.w.

It's over to Yeovil now, to **Don McLean G3NOF**. Don is a sideband specialist, and has beams at a decent height covering 14, 18, 21, 24 and 28MHz and a wire for the rest. Indoors there's a Kenwood TS-950S and a Drake linear.

On 28MHz the band opened to give 9G1AA, while Africa, N America and Asia were also noted. Don's 24MHz operations produced Navassa W51JU/KP1, and on 21MHz 9G1AA again and 18MHz was notable for V73C (ex-V73CT) noted around mid-morning with signals from the N Pole direction.

On 14MHz the Kingman Reef group, N9NS/KH5K brought a little joy. However, on 7MHz W3LPL and 3.5MHz PY0FM were not to be sneezed at.

Lower Power

Conditions, says **Leighton Smart GW0LBI** one of our lower power operators, have been very up-and-down. However, his best for the month had to be JH5PHC raised with 5W of c.w. on 14MHz, into a sloping dipole, for a RST599 report.



Contributor Don McLean G3NOF uses a Kenwood TS-950S.

Leighton likes 1.8MHz, and here he managed 1K4DCS (3W), DJ1KG (2W), F6BWO (2W), HB0/DL6SDVV/P (5W, phone); all in the evening. Finally, another shift, back to 14MHz and K3IZT who passed a 57 report on the 5W of s.s.b. from Leighton's rig.

Bits and Bobs

Now it's 'bits and bobs' time. Towards the end of May is the schedule for a possible Spratly expedition. The May 27 arrival date was quoted to me on May 23.

I would not normally mention an expedition that will be history by the time you read the column. But I feel that for amateur radio to insert a DX expedition into an area that is an admitted flashpoint, with China, Vietnam, Taiwan, Malaysia, Philippines and Brunei is asking for it when we know all these countries save Brunei have troops in the archipelago.

Last time someone tried for Spratly, people were killed. What is to happen this time? Incidentally, Fedor Koniukhov R0L/MM, who at the time of writing is heading for Bouvet, proposes to follow up with a Spratly visit. Have all these operators taken leave of their senses?

Rather more solid is the news of an upcoming Mellish Reef VK9M operation slated for middle to late September and eight days on the reef.

If you've been looking for Bouvet you may have hooked UA90BA operating as 3Y/R0L around the end of

June. But this is hardly the best time of year to attempt a landing.

I've heard that 404 cards may now be submitted for Bosnia credit with DXCC. Also with Bosnia, the new T9 prefix seemingly spells the end of the validity of the 404 prefix. Just what those two statements will mean in the real world is anyone's guess!

The proposed 5A expedition, **G4DYO** has some information that explains the high costs of this Romeo Stepanenko operation. And the information makes quite clear it is a serious attempt.

A big one now! Between July 15-18, YW5LT, will celebrate the anniversary of the Venezuelan Navy from Los Testigos Island.

Yasawa group, in the Iota Contest, will be represented by 3D2RF, who will be there July 21-27, following up as T26RF July 28 to August 3. If you work them, cards go to WB6RZK, Robert Ferrero Jr. 5Z4JD is F2JD until December; only 18MHz of the new bands is permitted; operation c.w., sideband, and satellites.

Deadlines

That's it for this time. Deadlines as always, and send your reports to **287 Heol-y-Coleg, Vaynor, Newtown, Powys, Wales, SY16 1RA**, to reach me by the middle of the month. Till then, Good Hunting.

E N D

ALTRON TOWERS AND MASTS

QUALITY AT A GOOD PRICE

- ★ Telescopic, tiltover
- ★ Fixed
- ★ Static, mobile
- ★ 4.5m and 3m section modules for low retracted height
- ★ Fully galvanised to BS729/5750 Pt II

Over 50 models available from 3m – 60m including the popular and proven SM30 and CM35 masts. Design windloads based on BS CP3 CHAP V 1972 (BS8100) for windspeeds up to 100 mph / 45 m/s.

Used by such professional bodies as: BT; Home Office; DTI; British Aerospace; British Gas and the Police.

ALITOWERS AND MASTS

From 5m – 21m telescopic and 70m fixed. Using our unique robust leg extrusion, Alimast is strong, light, attractive and affordable. All Alitowers and Masts come with stainless steel fittings and winch ropes.

AQ6-20 'SPACE SAVER'

compact 4 bander with 2, 3 or 4 elements. 6, 10, 15 & 20m.

- Unique fully sealed coils ● Hi 'Q' close coupled capacity hat loaded yagi with optimised performance
- Ideal for small spaces ● Full specification sheet available.

Send large SAE for full details or phone for quote.

UNIT 1, PLOT 20, CROSS HANDS BUSINESS PARK, CROSS HANDS DYFED, S. WALES, SA14 6RE
Tel. 0269 831431 Fax 0269 845348

ALTRON COMMUNICATIONS EQUIPMENT LTD

H.P. Terms



KITS AND READY BUILT PRODUCTS

A wide range of quality kits & modules for the home constructor

LINEAR WITH PREAMP, 2 or 4 or 6 metre versions, RF switched, all mode SSB/FM/CW/DATA. Powers available, 2.5W in 25W out. 5W in 25W out, 5W in 40W out, 10W in 40W out, state requirements when ordering. RX gain 0-20dB panel adjustable. RX NF <1dB typical. Types TARP2S, TARP4S, TARP6S. **BOX KIT £72.75, BOX BUILT £98.25.**

LINEAR AMPLIFIER, 2 or 4 or 6 metre versions, RF switched, all mode SSB/FM/CW/DATA. Powers available, 2.5W in 25W out, 5W in 25W out, 5W in 40W out, 10W in 40W out, state requirements when ordering. Types TA2S1, TA4S1, TA6S1. **BOXED KIT £56.25, BUILT £70.50**

TRANSVERTERS from 10 metres for 2, 4 or 6 metres. 0.5W output RX gain 15dB, NF <1dB. NEW larger box allows inclusion of 25W linear amplifier, see below. Types TRC2-10b, TRC4-10b, TRC6-10b. **PCB KIT £55.50, PCB BUILT £89.50, BOX KIT £78, BOX BUILT £116.**

TRANSVERTERS for 1mW 10 metres drive, including buffer board, otherwise as above. Types TRC2-10b, TRC4-10b, TRC6-10b. **PCB KIT £64.25, PCB BUILT £100, BOX KIT £85.75, BOX BUILT £132.**

TRANSVERTERS from 2 metres for 4, 6 or 10 metres, 0.5W output. Includes interface to accept 0.5-5W drive. Types TRC4-2i (built only). TRC6-2i, TRC10-2i. New larger box to include linear. **PCB KIT £64.25, PCB BUILT £100, BOX KIT £85.75, BOX BUILT £132.**

LINEAR AMPLIFIERS to suit the transverters above. 0.5W in 25W out. Types TA2S3, TA4S3, TA6S3. **PCB KIT £60, PCB BUILT £80.75**

COMMUNITY BROADCAST TRANSMITTER, 88-108MHz, 0.5W. Wideband FM meets the requirements of the DTI Restricted Service Licence. Synthesized 40 channel in 50KHz steps giving a 2MHz portion of the broadcast band. Audio passband 150Hz to 15KHz. Types CTX100, ready built £110.00. Also 25W continuous rated matching Class C amplifier type TA100C3, ready built £110. Omnidirectional folded "J" aerial for the above, £30 inc P&P.



VAT & P&P inclusive prices. Send SAE for free full catalogue



SPECTRUM COMMUNICATIONS

Unit 4 Grove Trading Estate, Dorchester, Dorset. Tel 0305 262250
Opening times: 9-1 2-5 Tue-Fri, 9-1 Sat. Closed Sun & Mon

NEW 3rd EDITION – UK SCANNING DIRECTORY

HAYDON COMMUNICATIONS – 081-951 5782

WHY NOT PART EXCHANGE YOUR OLD EQUIPMENT – TOP PRICES PAID!

HF CORNER

"THE UNBEATABLE THREE"

KENWOOD TS-950S
The Ultimate HF TCVR
£3095 One Only (As New)

TS-850S
Still Going Strong
One Only **£1395**

TS-50S ALL MODE MINI HF MOBILE/ BASE

NEW **PHONE**

DRAKE R-8E **£989**
You'll never want another receiver **FREE DEL.**

Yaesu FRG-100 **£549**
All mode General Cov. HF Recvr (It's a knockout!) (incl's PSU) Free Delivery

Sony ICF 2001D **£269**
0.15-30MHz All Mode + FM broadcast / AM Airband **SAVE £70** **£359**

UHF-VHF TRANCEIVERS

DJ-580SP 2m/70cms TX + wideband RX
Now with CTCCS **£429**
FREE EXTRA NICAD PACK

ALINCO DJ-180E 2m TX + Wideband RX **£209** **£189**

DR-112E 45W FM Mobile **£309** **LIMITED STOCK!**

KENWOOD BETTER BY DESIGN

TH-78E SPECIAL 2m/70cms Tx + Wideband Rx (FREE this month: Extra Nicad) **£465.00**

TH-28E 2m Tx/70cm Rx
***TH-48E 70cm'sTx/2m Rx** (Novice Recommended)

TM-732E High Tech/Small Radio 2M/70cms Mobile **£Phone**

FULL KENWOOD RANGE AVAILABLE

NOTE:- WE ARE ABLE TO SUPPLY ALMOST ANYTHING SHOWN IN THIS MAG. £Phone

SCANNER CORNER

MVT-7100 The Two in One Recvr! **£399**

AR-1500EX Now improved even more! 0.1-1300 MHz all mode incl's SSB **£315**

AR-3000A "THE BEST" 0.1-2.03 GHz ALL MODE! UNBEATABLE SW PERFORMANCE **£849**

OPT-2300 Frequency Finder (1-2.3GHz) **£159**
Includes Nicads and Charger

WHERE TO FIND US



IT'S EASY WHEN YOU KNOW HOW!

24 hour salesline 0850 586313 ★ Mail Order: Same Day Despatch ★ Sales/service:- (Phone/Fax) – 081-951 5782

Open:-

132 High Street, Edgware, London HA8 7EL

Close to Edgware underground station (Northern Line). Close to M1, M25, A406. ★ FREE PARKING ★



ORDER YOURS NOW FREE POSTAGE

**SERVICE
MANUALS**

TEST EQUIPMENT MAINTENANCE

**SPARE
PARTS**

Did you know that we provide repair and calibration services, supply technical manuals, and spare parts for test equipment - manufactured by over 100 different companies?

POWER SUPPLIES, SIGNAL GENERATORS,
SPECTRUM ANALYSERS, AMPLIFIERS,
FREQUENCY COUNTERS, MULTIMETERS
(ANALOGUE & DIGITAL), OSCILLOSCOPES,
POWER METERS ETC. ETC.

FULL TECHNICAL SUPPORT INCLUDING
PROFESSIONAL DESIGN,
DEVELOPMENT, COMMISSIONING,
CONTRACT MAINTENANCE AND
SYSTEM INTEGRATION

Hesing Technology

**NEW &
SECONDHAND
TEST EQUIPMENT**

Cromwell Chambers,
8 St. Johns Street
Huntingdon,
Cambridgeshire
PE18 6DD

**REPAIR &
CALIBRATION
(TRACEABLE IF
REQUIRED)**

Tel: (0480) 433156
Fax: (0480) 413357

It's Never Been Easier to Join the RSGB

IN A MAJOR SURVEY of UK radio amateurs last year, we discovered that many of you would like to join the RSGB but are put off by having to pay a whole year's subscription in one go.

So we've made it easy for you to spread your payments over a year*. Simply fill in our Direct Debit form when you join and your bank will take care of the subscription for you.

Benefits of membership include: Every month our colourful, information-packed, 100-page magazine, *Radio Communication* will be delivered to you. The free QSL

Bureau will be at your service for outgoing and incoming cards. You will be entitled to a 15% minimum discount on our huge range of amateur radio books and accessories.

A small army of experts will be available to help and advise you on crucial issues like planning and EMC. And you will be the first to know about the Society's work on licence conditions and international regulations.

**CALL US ON
0707-659015
OR WRITE FOR AN
APPLICATION
FORM**

Contact us NOW about joining the RSGB and we'll send you full details of our optional Direct Debit scheme.

* Direct Debit Example: Corporate Membership = four quarterly payments of £8.50.



**RSGB (Dept PW8)
Lambda House, Cranborne Road,
Potters Bar, Herts. EN6 3JE**



VIBROPLEX®

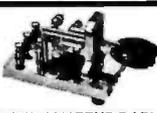

AVAILABLE IN EUROPE
from
EASTERN
COMMUNICATIONS
CAVENDISH HOUSE
HAPPISBURGH
NORFOLK
0692-650077

FOR THE PROFESSIONAL AND AMATEUR RADIO OPERATOR WHO DEMANDS QUALITY

Please mention

**practical
Wireless**

when replying to
advertisements

G6XBH G1RAS G8UUS

VISIT YOUR LOCAL EMPORIUM

Large selection of New/Used Equipment on Show

AGENTS FOR:

YAESU • AZDEN • ICOM • KENWOOD • ALINCO
Accessories, Welz Range, Adonis, Mics, Mutek Pre-Amps
Barenco Mast Supports, DRAE Products, BNOS Linears & PSUs
* ERA Microreader & BPS4 Filter, SEM Products *
* Full range of Scanning Receivers *

AERIALS, Tonna, Full Range of Mobile Ants, Jaybeam

BRING YOUR S/H EQUIPMENT IN FOR SALE

JUST GIVE US A RING

Radio Amateur Supplies

3 Farndon Green, Wollaton Park, Nottingham NG8 1DU
Off Ring Rd., between A52 (Derby Road) & A609 (Ilkeston Road)
Monday: CLOSED. Tuesday-Friday 10.00am to 5.00pm. Saturday 9am to 4pm

Tel: 0602 280267

R.A.S. (Nottingham)

R.A.S. (Nottingham)

Scene

WE
T
E
L
L
S
A
T
E
L
L
I
T
E
S

This month, Pat Gowen G3IOR has some good news on the progress of AMSAT Phase-III-D and OSCAR-13's new schedule.

Much planning and thought has been going into the coming Phase-III-D satellite, with meetings between the designers and builders from the US, Canada, Germany and Japan. The AMSAT Engineering Vice President W4FAB announced that the revised design has been "proceeding nicely".

A great deal of W4FAB's own effort has been spent on structural and thermal analysis. This has led to design confirmation of the three point separation support mount and the cylindrical launch adaptor, in which the spacecraft rides into space.

The layout and routing of heat pipes needed to cool the sunlit side of the spacecraft and remove heat from the high power transmitter modules is also resolved. An engineering model should be available by mid-summer, followed by the fabrication of the flight spaceframe, completed by spring '94.

Overall Design

The overall design of the Phase-III-D satellite is now a hexagonal cylinder 2.240m across the points, 1.12m sided, 675mm high structure weighing 400kg. Two of the faces will accommodate about half the spacecraft's compliment of solar cells, with the rest mounted on two deployable panels.

Solar panels will cover two of the flat side surfaces, and the panels will unfold using a double hinge mechanism. The total span with these panels when deployed will be some 6.450m.

The satellite will be carried by the Ariane-5 launcher inside a large cylinder, and the spacecraft will be ejected from it. The relative size compared with OSCAR-13, an average-sized person, and a microsat, can be seen in Fig. 1.

The high gain antennas, originally planned to be on the spacecraft's underside, have now been relocated to the top motor nozzle side of the spacecraft. Computer modelling has shown that

heat from the nozzle is not expected to present a significant problem.

The change permits the antennas to project farther above the surface, making it possible to use more conventional designs. For example, 'S' and 'C' bands will now share a single dish with a dual band feed.

The dish can be contrasted with the flat patch arrays that would have been required in the original location, the side opposite the nozzle. The 435MHz antenna however, will continue to use a six patch array surrounding the motor nozzle.

Stan Wood WA4NFY, Bob Stilwell and several John Hopkins University students are those principally working on the Phase-III-D antennas. For 145MHz, three half wave dipoles are planned. However, 29MHz antennas will use whips to form a 2-ele beam.

Estimated gains for the various bands provided are 29MHz 4dBi, 145MHz 8.4dBi, 435MHz 13dBi, 1.2GHz 15.5dBi, 2.4GHz 17dBi, 5.6GHz 19dBi and 10GHz 20dBi.

Control Computers

Peter Gulzow DB2OS has provided information on the data handling and satellite control computers on Phase-III-D, along with the local area network (LAN) that connects them to the various on-board systems.

The LAN employs two busses, one running at 100 to 200 Kilobits per second, the other at about 1 megabits per second. The high speed LAN will handle the data, the other will take care of control functions. **Keith Baker KB1SF**, proposes to provide a more formalised scheduling structure using a commercial software package with interface documentation much like that used on OSCARs 10 and 13.

Miki Nakayama JR1SWB and the JAMSAT group are providing cameras. Two earth-looking cameras, plus another with a longer focal length unit looking out into space are proposed.

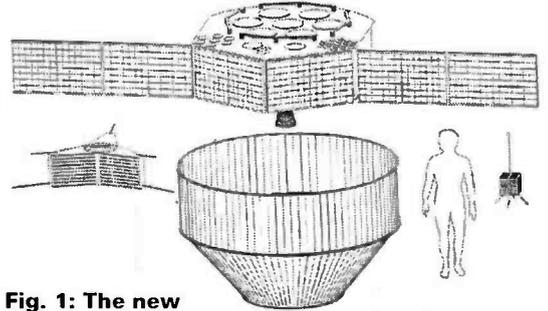

Fig. 1: The new shape of Phase-111-D, compared with its predecessors and an average builder.

Satellite Frequencies

At the Phase-III-D transponder meeting in Bavaria, the following frequencies were chosen for the coming satellite:

Downlink frequencies (Satellite-to-Earth)

- 1: 10.451000 - 10.451500GHz
- 2: 2400.500 - 2400.900MHz
- 3: 436.000 - 436.400MHz
- 4: 29.310/29.320/29.330/29.340/29.350MHz with one of these frequencies selected by the control station.

Uplink frequencies (Earth-to-Satellite)

- 1: (A) 1269.000-1269.500MHz, (B) 1269.500 - 1270.000MHz
- 2: (A): 435.200 - 435.700MHz, (B) 436.000 - 436.500MHz
- 3: 145.800 - 145.975MHz

All the bands listed, except for 29MHz, are planned to be switched in a matrix to allow any configuration of operational modes. Minor last minute changes or additions are still possible, depending on the transponder builders.

Tom Clark W3IWI, has suggested using a central oscillator to control all receivers and transmitters. The correction would be applied to the output to remove the effect of changing Doppler shift as the satellite traverses its orbit.

Tom pointed out that unless something is done, Doppler shift will be particularly troublesome at 10GHz. His concept also calls for the central oscillator to be referenced to GPS to provide a very accurate frequency source. Tom says that from the high elliptical orbit which Phase III-D will use, it should be quite possible use the GPS concept, in addition to optical sensors, for attitude determination.

Karl Meinzer DJ4ZC reports that the 430MHz transmitter is expected to be built in Germany. Offers for the 145MHz, 2.4GHz and 5.6GHz transmitters have yet to materialise.

As for the funding of Phase III-D, AMSAT National organisations world-wide have set up sources to help pay the costs of the new satellite. Any contributions are gratefully received. In the UK send to **AMSAT-UK, London, E12 5EQ.**

OSCAR-13 Multi-Mode

James Miller G3RUH and his fellow controllers have had to change the 1993 schedule for OSCAR-13. The problem has been bought about by the sudden demise of OSCAR-13's L Mode transmitter so limiting transponder operations to the remaining S and B Modes. On the proviso that the sun-angle and battery charge permits, Mode S can now assume the times previously assigned to Mode JL. It is anticipated that in the third quarter of 1993, the S Mode exclusive period will be longer, Mode SB will be invoked for some hours, and the S Beacon well exercised. At the time of writing, no firm new schedule has been made, as the variables of the new power demand ratio have yet to be found.

Recent rare DX worked via OSCAR-13 includes A22BW, 9M2FL, N8GHU/HH5, YB1CS, FR5DN, XX9AJ and JG1RMB/JD1. Have you any to add to this, or any interesting findings! Cheerio until next time.

E N D

Report

VHF

David Butler G4ASR presents his monthly look at what's going on in the world of v.h.f. starting off with a look at propagation conditions.

The v.h.f. bands during May were pretty uninspiring. Although there were periods when the bands were 'up' and many tropo contacts could be made. The best days were between May 11-12 and May 23-26. The preferred paths seemed to be north-east towards Scandinavia and north-south within the UK.

Derrick Dance GM4CXP (IO85) worked a number of OZ stations on the 144MHz band. On May 12 he also heard the OZ1UHF beacon on 432.955MHz.

During the same evening the station of **G0CQD** (IO94) worked LA0GH (JO38), LA2PHA (JO38), OZ1BUR (JO46) and OZ4VV (JO46). All worked on the 144MHz band.

The period between May 24-25 was particularly good. And **GM0ILB** (IP90), **GM4AFF** (IO87), **GM4CXM/P** (IO76) were heard making many QSOs into central England.

Aurora Propagation

Very little auroral propagation was recorded during May. A number of stations around the UK reported openings on May 7, 8, 9, 10, 11, 12, 17 and 28, but most were weak events. Nearly all of the events occurred late in the evening between 2200-0200UTC. **Ray James GM4CXM** heard the OY6VHF beacon (144.885MHz) at 2345UTC on May 7. At 0018UTC Ray worked OY9JD (IP62) on the 144MHz band. He then heard LA3NGA (JO49) and LA5SAA (JO29).

An opening to Sweden was reported on May 10, but because of the late hour not many UK stations were active. As I've mentioned before, it's recommended that you listen out for the GB3LER (144.965MHz) and SK4MPI (144.960MHz) beacons. However, if you want a little bit more warning it's useful to monitor various Band I TV transmitters.

I have 48.240MHz, 48.250MHz, 48.253MHz, 49.740MHz and 53.757MHz

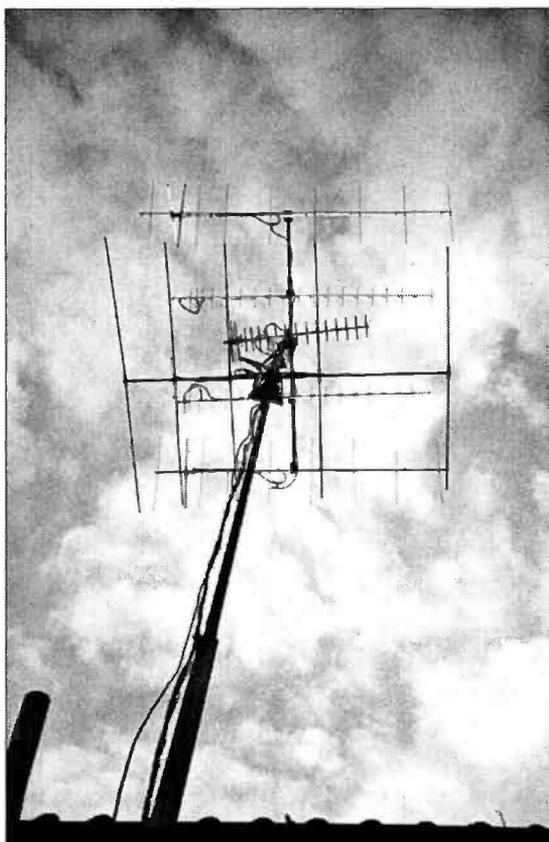

Fig. 1: An antenna tree with branches for 50, 144 and 430 MHz.

stored in the memory of my Kenwood TS-690S. As soon as there's a whiff of an aurora, they burst into life. They're also useful for monitoring the meteor and Sp-E activity.

First Sporadic-E

Well it happened just like I said it would, with the first 144MHz Sp-E opening this year, which occurred on May 12. This is quite early in the season, but none the less not unexpected. It was a surprise however, that the distant end was SV1, SV3, SV4, SV5, SV8 and SV9! That's three DXCC countries, Greece (SV), Dodecanese (SV5) and Crete (SV9).

A report from **Ken G4IGO** (IO80) says it began with an opening from the south coast to southern Italy and Sicily between 1210-1232UTC. Later, between 1551-1605UTC G4IGO worked SV9ANJ (KM25) followed by an SV1 (KM18) between 1633-1650UTC.

Around 1800UTC, I heard an enormous pile-up on 144.300MHz, the s.s.b. calling frequency. Unfortunately my QTH (IO81) wasn't in the right location for this opening. However many stations in south-east England including G3IMV, G3KEQ, G4RGK and G6HKM were heard calling and working the Greek stations.

Tony Wayland G7HJW, reports that at 1800UTC he was working many Italians on the 50MHz band. Out of curiosity he moved up to 144MHz, to see if there was any activity and was very surprised to hear the band open to southern Italy. Following a quick s.s.b. contact with IK7UXY (JN70), Tony decided to tune around for the real DX. The first station to be found was SV3KH (KM07) with a pile-up of stations from DL, F, ON and HB9 calling him. Although SV3KH didn't seem to be hearing the UK stations very well Tony persevered,

and was pleased to contact him on the third call.

The station at G1HJW consists of an FT-726R, a 100W amplifier and 2 x 9-element crossed Yagis configured for circular polarisation. The photograph, Fig. 1, shows the 144MHz antennas, the 5-element 50MHz Yagi and 2 x 19-element crossed Yagis for the 430MHz band.

Tony found that an elevation of 10° produced the strongest signals from SV3KH. Has anyone else noticed this effect?

Locator Map

If you look at the locator map shown in Fig. 2, you'll see that the opening just reached into southern England. Stations located in Belgium, northern France, Switzerland and southern Germany were more favourably located for the opening into Greece.

At the QTH of **Marcel FE1DQK** (JN18), the opening started at 1600UTC and continued for an hour. Between 1603-1643UTC he made s.s.b. contacts with SV1AB, SV1OH, SV1RK, SV1UM, SV1VS, SV1WE, SV4LD and SV5ANJ. Because of QRM from a very local amateur, Marcel moved to the f.m. portion of the band (145.500MHz). Between 1700-1701UTC f.m. contacts were made SV1LD and SV1SN. Signals were very strong, and it's interesting to note that the SV stations were using simple antennas with vertical polarisation.

The conditions in southern Germany were equally superb. **Robert Trentz DL5GAC** (JN47) worked an SV1, an SV3 and five SV9s (!) between 1646-1752UTC. He runs 350W into 4 x 15-element Cue-Dee Yagis.

The opening at the QTH of **Robert HB9JAW** (JN46) occurred between 1525-1820UTC. He had been logged into the DX Cluster, and noticed many 'spots' for 50MHz stations to the south-east.

Pointing his 144MHz beam south-east and tuning the receiver to 144.300MHz, Robert immediately found SV9ANJ (KM25). He was 50dB over S-9! Following the contact a 4X1 station, possibly 4X1IF, called HB9JAW.

Regrettably, the huge pile-up on 144.300MHz didn't allow the contact to be made. As some compensation, further SV-stations were contacted in eight locator squares. At 1820UTC a contact was made with an Italian station only 924km away. This indicates that the maximum usable frequency (m.u.f.) was approaching 200MHz or so.

Although I've concentrated on the path to the south-east, the Sp-E 'cloud' also supported communications in other directions. I've included in the diagram, Fig. 2, alternative paths which were open at the same time. These were based on reports from F6DRO (JN03) who worked LZ and YU between 1548-1800UTC and PE1LAU (JO33) who contacted stations in I and IT9 between 1614-1830UTC.

The station of OE3KLU (JN88) reported s.s.b. contacts with 9H1, 9H5 (Gozo) and IT9 around 1600UTC. Charley made the contacts with 25W and an indoor 4-element vertical Yagi. Another Austrian, OE1DMB, using 25W and a 1m long car antenna (!) also worked stations in 9H1 and IT9.

Finally, I've received a report from Bob LZ2BE who contacted TK5EP (Corsica) and EA3BVS. He also heard 19 Spanish stations between 1520-1700UTC on packet radiol

These reports prove what's been said many times. If the band is open, and you're located in the right place a QRP station will be as competitive as a mega-station. And in many cases may do even better!

On June 22, I made 103 s.s.b. contacts in 100 minutes with stations in 9 countries. These included 60 x YU, 17 x I, 12 x OE, 5 x DL, 4 x SP, 2 x HG, LZ, SV and YO. On the following day c.w. contacts were made into Russia with RA3LW and UC2CBZ. Note the predominance of stations to the south-east.

The 50MHz Band

During May, the main propagation mode to effect the 50MHz band was Sp-E. However, I'll concentrate on

the new countries QRV and the real DX that was worked.

The station of UC2AA (K033) was first reported into the UK on May 9. But it wasn't until 0926UTC on May 13 when G4UPS claimed the first 50MHz QSO with UC2.

The only legal operator in Andorra is C31HK (JN02) and he was noted many times during the month operating on 50.203MHz. In common with the French allocation, he's not permitted to operate below 50.200MHz.

On May 27 between 1615-1730UTC, both EV8A and EV9A were putting in good signals from the Belarus Republic.

The only real DX to be found, was on May 12 when ZS6WB, Z23JO, 7Q7CM and 7Q7JL appeared on the band between 1555-1920UTC. Unfortunately, many European stations were operating within the DX window 50.110-50.130MHz and causing much QRM.

Other stations worked during May and worth looking out for included CN8CC, CN8HB, CN8ST, CT3FT, EH6ET, EH6IF, EH6VQ, EH9IB, ES1CW, ES5QA, ES6QB, OY3JE and 4X1MH.

As I've already mentioned you'll now be hearing signals from all over Europe, sometimes all at the same time! If you're really clued up you should be searching for the real DX from other continents such as Africa, Asia, South America and North America.

In last year's log book I noted contacts during July with many stations including CN, EH9, OD, TA, VE, W, ZC4, 4X4, 5B4 and 9K2. Don't forget to look out for mixed-mode propagation such as Sp-E extending into the trans-equatorial (t.e.p.) path.

Typically, contacts can be expected with stations in Southern Africa and South America. You can also expect the transatlantic path to open up via multi-hop Sp-E during July. The peak time to monitor for this propagation is between 2100-2300UTC. You may find it useful to listen on the 28MHz band for strong US stations.

Meteor Scatter

I've been 'reliably' informed that this year's Perseids meteor shower will produce spectacular results! The shower is associated with the comet Swift-Tuttle which recently had its closest approach with the earth.

It has been suggested that debris in the wake of the comet may enhance the

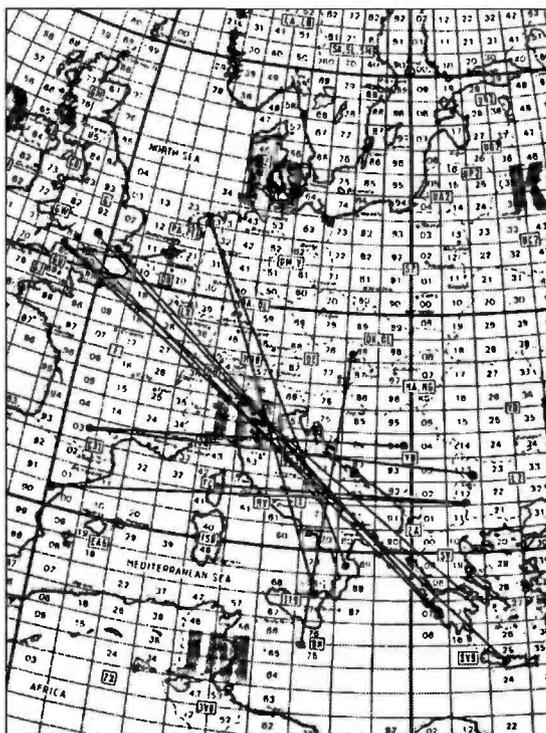

Fig. 2: Sporadic-E paths during May just reached into southern England.

meteor rate tremendously. Predictions indicate that the shower may be at its best between 1800UTC on August 11 and 0600UTC on August 12.

The only way to test this theory is to be on the v.h.f. bands in a few weeks time. Let me know what results you had!

Expeditions

Members of the St. Petersburg Radio Club UZ1AWT will again be QRV from UA1. They'll operate from Primorsk (KP40) with the call sign RU1A. Most activity will be at the weekends between June 5 to July 31. QSL via KC1WY if you do manage to work them.

Last month I briefly mentioned that GM4CXP had signed up for the Lithuanian expedition LY93BDX. Although not primarily a v.h.f. expedition, it's expected that equipment for the 50MHz and 144MHz bands will be available.

The multi-national group will operate from locator KO05 between July 24 to August 4. Derrick is also planning to operate portable as LY/GM4CXP on the 144MHz band with an IC202E (s.s.b./c.w.).

Jerry G4SEU and Roger G4WND will operate from locator IO78 during the Perseids meteor shower. They'll be active on the 50MHz and 70MHz bands between August 11-12 and use the callsigns GM4SEU/P and GM4WND/P.

The operating schedule for random operation on both days is 0900-1300UTC

on 70.170MHz s.s.b., and 1700-2000 on 50.370MHz s.s.b. The time between 2000-2130UTC is devoted to crossband operation.

They will transmit on 70.170MHz and receive on 50.370MHz. Between 2200-0100UTC they'll be on 70.170MHz for further s.s.b. random operation. One minute periods will be used with breaks every 15 seconds.

The GM end will transmit first period. For clarity this means (for example) 1200-1201, 1202-1203, etc. Another way of expressing this is to say GM will be transmitting during 'even' periods, 00, 02, etc.

The group will also be QRV on 14.345MHz, 7.048MHz (0800UTC) and 3.748MHz (0830UTC) to arrange schedules. Alternatively you can telephone G4WND (prior to August 5) on (0827) 894464.

Stock Photographs

My stock of photographs is getting rather low. Pictures of your shack, antennas or any v.h.f. activity are especially welcome. Other pictorial items such as QSL cards, awards, certificates, etc. are also required. They will all be returned to you!

Please send your news to me at Yew Tree Cottage, Lower Maescoed, Herefordshire, HR2 0HP or via packet radio @ GB7MAD or the DX Cluster system.

E N D

Panorama

PACKET

Roger J. Cooke, G3LDI describes the new AEA PK-900 data controller, before discussing band-plans and channel spacing.

The new multi-mode controller from AEA is between the tried and tested PK232 and the new DSP (Digital Signal Processing) units. In fact the only difference is that the PK-900 has no DSP, neither does it have a satellite modem included. You can see, in the top photograph, that it's totally different to the PK232. It has a large, back-lit l.c.d. read-out, making important status and mode information easy to see. It also includes a 20-segment tuning indicator with selectable tuning functions.

All modes are covered, including grey-scale FAX, and TDM (a type of frequency-sharing AMTOR). Optional plug-ins for 9600 baud and PACTOR are available. The basic price, depending on exchange rates, is expected to be £499.95. The add-ons, such as (if you can afford it) the DSP-2232 are also available from ICS Electronics in Arundel, Sussex.

I've not covered DSP in my column as yet, but hope to do so in the near future. When I do, I hope to have some more detailed information regarding the products available.

Local Sysops Meeting

The East Anglian Data Group (EADG), held a meeting in Thetford recently and one subject discussed was the situation on 430MHz. Information from the DCC was read out at the meeting and a brief summary is produced here as there seems to be quite a bit of confusion and lots of conflicting views.

430MHz Sub-bands

There are four sub-bands: A (430.625, 430.650, and 430.675MHz) B (432.625, 432.650, and 432.675MHz) C (433.625, 433.650, and 433.675MHz)

D (439.825, 439.850, 439.875, 439.925, and 439.975MHz) Bands A and D are for inter node/BBS linking, simplex and duplex, with no user access. Bands B and C are for user access, BBS access, DX cluster, and TCPIP.

In addition there are two wide-band channels, 430.725 and 430.775MHz, making 16 spot frequencies in the 430MHz band.

Main station address unattended operation, is in sub-bands B and C (allowed from the 1 April 1993). But BBSs can only operate unattended on the frequency on their NOV, which at present limits them to 432.675MHz.

We hope to be able to use one spot frequency per sub-band per BBS in the near future. The delay is due to a mis-print in the agreement with the RA. Unattended operation other than in sub-bands B and C needs site clearance from the RA.

The DCC have negotiated long and hard with the RA for these changes, and finally they have agreed to our requests. We are also negotiating to issue NOV for remote sites as well in an effort to try to speed up the remote site clearances, which at present take an age to clear. My thanks to Tom Lilley, G1YAA, Secretary of the DCC for this information.

PACTOR Revisited

A plea, from Roy Philpott DJ00W, for publicity(?) was sent to me via PW. Quite a lot of detail about PACTOR has been published in past issues of PW, and I understand that activity on the h.f. bands is on the increase. Add-on units for the PK-232 and KAM are now available. Also a dedicated PACTOR unit is available from Siskin Electronics and costs around £250.

PACTOR overcomes the

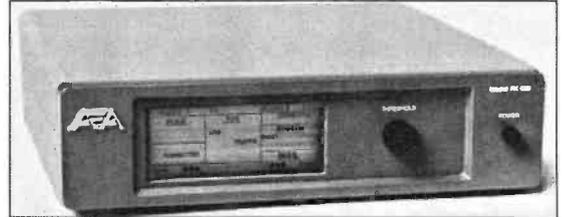

The new AEA PK900 Data Controller available for about £500 depending on the configuration you want.

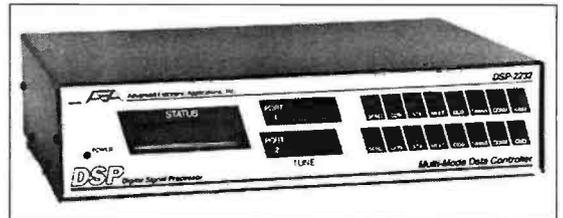

Roger asks, "Can you afford this superb multi-mode Controller from AEA?"

problems that AMTOR suffered from. Look at some of the messages on the Packet network that have come in from an AMTOR link and you will see some occasional errors. PACTOR is more tolerant of poor conditions, polar paths, and has the additional advantages of using the full ASCII character set and a transmission speed automatically adjusted according to the quality of the radio link.

The throughput speed can vary from 100 to over 300baud, using a 16-bit CRC (Cyclic Redundancy Check) for error detection. In the latest software, the maximum communication distance has been improved to over 40,000km. This has been achieved by increasing the total cycle time to 1.4 seconds, leaving a much longer window for receiving.

Terminal programs are available for most computers, so look on 14.079MHz and join the ever-increasing PACTOR group. Who knows, this might be the replacement for packet for h.f. traffic handling!

Channel Spacing

We all know what this

means! It is obvious what will finally happen, but the time scale is the problem.

There is a mixture of 25 and 12.5kHz spaced gear around at present, so the change will have to be gradual. We decided to try to encourage amateurs to change by having access to a packet clinic, where they can have their equipment checked for deviation, adjusted and finely tuned.

We decided to aim for a date of 1 May 1994 for the change, with the added advantage that another six months would be added to that before the change became permanent. This would give time for everybody to change their gear, deviation or whatever, and still be able to communicate comfortably.

We are doing our best to conserve what limited bands space we have by changing to 12.5kHz channel spacing.

Talking about space, it's beaten me again! More packet group details please! 73 and happy packeting de Roger, G3LDI @ GB7LDI QTHR Tel: (0508) 70278.

E N D

Round-up

BROADCAST

It's summer time again, and many of us are disappearing on holiday, and some will be lucky enough to be travelling overseas. But does this mean being cut off from the real world, denied access to news, sports results or the Top 40? No, it certainly does not (unless, of course, you are trying to escape from the depressing nature of the daily news and the performance of the English cricket team).

Portable short wave receivers are readily available, and at prices to suit all pockets and tastes. If you simply want to listen to the powerful signals of the BBC World Service, or other major international radio stations, then all you will need is a small set. Perhaps along the lines of the seven or eight-band pocket sized radios produced by Sony and Grundig, or those imported by the Roberts company. You could kit yourself out for somewhere between £40 and £70, and not be charged for excess baggage if you are flying.

But if you like listening to more exotic stations you'll probably need something more sophisticated. Digital readout is a must, for precise identification of frequencies, and a b.f.o., or better still, selectable upper and lower sideband, will prove invaluable.

Digital tuning radios cost more than traditional analogue (or dial and pointer) sets. However, you'll benefit from more accurate tuning, without frequency drift and the ability to resolve s.s.b. And s.s.b. means you can tune in to radio amateurs.

I've used a Panasonic RF-B65. This is a digital set with b.f.o., and covers 1.6 to 30MHz. It performed rather well, and although it costs around £150, probably represents good value for money. An alternative choice might be the smaller brother of the RF-B65, the RF-B45, which also has

b.f.o., is a touch smaller and retails at around £135.

Sony make the ICF-SW7600 (around £160) which is compact - no larger than a standard paper back book and has b.f.o., memories and stereo f.m. Another Sony, the SW55, (at £250) has switchable s.s.b. and synchronous detection and lots of memories, whilst the larger SW77, for £350, has 162 memories and all the features found on the SW55.

When travelling, it's worth taking wire to extend the antenna, via the external antenna socket of the set. Drape the wire out of the hotel window, and reception will probably improve dramatically. Don't forget to DX the medium wave bands. If you are in East Africa, for example, All India Radio is likely to be heard on medium wave.

In The News

Many people have to travel for their jobs, and some that have been in the news lately are peace keeping troops who are active in the former Yugoslavia, Somalia and Cambodia. Some of the contingents come from Australia, and the Australian Armed Forces Radio broadcast programmes directly to the troops overseas.

Until recently, special programmes were transmitted over Radio Australia's facilities, but now the Electronic Media Unit of the Armed Forces has taken over the transmitting of programmes. It uses 40kW s.s.b. transmitters and beams programmes to Somalia and towards Cambodia. The current schedule is, to Somalia: 0300 on 19037.5kHz, 0900 on 25322.5kHz, and 1400 on 13508.5kHz; and to Cambodia: 0300 on 23678.5, at 0900 on 20418.5kHz and 1200 on 12070.5kHz.

In a recent interview on Radio Netherlands' *Media*

This month Peter tells you how to keep listening while you're on holiday, and how to listen to stations broadcasting to Australian peace keeping troops. After telling you about more TV channels on Astra, he mentions news from Yugoslavia.



The Sony ICF-SW7600 is compact, no larger than a paper back book and has b.f.o., memories and stereo f.m.

Network programme, Hugh McKenzie of the Australian Armed Forces Radio suggested that the broadcasts are likely to continue for the coming twelve months. Reception reports will be verified, if correct, and should be sent to: **Hugh McKenzie, Department of Defence, EMU, Anzac Park West, APW, 1/b/07, Reid, ACT 2601, Australia.**

The third Astra satellite was launched successfully at the beginning of May, and tests should have commenced by the time this edition of *PW* reaches you. A further 18 TV channels are to be carried on Astra 1C, and several additional radio stations will be transmitted. These could include National Public Radio, whose morning and afternoon current affairs programmes *Morning Edition* and *All Things Considered* (equivalent to Radio 4's *Today* and *PM*) are likely to be heard.

From Yugoslavia there comes a short wave relay of a local Belgrade station. Radio Ju, heard in Belgrade

on f.m. at 100.4MHz, is on the air daily via Radio Yugoslavia's transmitters on 9.505MHz between 1400 and 1600UTC. News in English is carried from time to time. The English international service of Radio Yugoslavia is heard at 1130 to 1200 on 21.605, at 1830 on 6.10 and 17.71MHz, at 2100 on 9.505 and 6.10 and we have received reports of an irregular transmission at 1000 on 9.58 and 11.805MHz.

Another domestic station from south-east Europe is also heard on short wave. Romania's Radio Actualitati is on at 2200 to 0500 on 7.255, and at 0500 to 1130 on 15.25 and 11.94MHz.

So, until next month, good listening and don't forget to send your letters to me via the *PW* offices.

E N D

FREQ COUNTERS. Advance TC.8 general purpose Freq counters to 32 Megs 7 digit with TCXO timebase bench unit for 240V size 17 x 6 x 11" max sensitivity 10 Mill/V as BNC type connec, old unit but good quality with end view Nixie tubes tested. £34.50. Tech/Hbk if req. £4.50. **METER EHT** Standard Electrostatic type 6/18Kv in wood carry case. £28.50. **MAST ARMY LIGHTWEIGHT** telescopic 27ft manual operation 5ft closed suitable whip or long wire. £48. Accessory Kit. £12. **MORSE KEYS** Army general purpose adjustable. £8.50. **VARIACS** 240/270V at 2 amp for int mounting new. £26.50. Qty available. **MORSE LAMPS** Aldis type 5" ex Navy new condition but no bulb fitted suitable L.V. type only £24.50. **C.R.L. BRIDGE** CT492 general purpose Bridge with Decade meter indication for use on 9V DC tested see list. £65. **ARMY R216 VHF Rx** 20/155 megs AM/FM/CW film scale tuning, BFO, Cal. Wide & Narr Sel, O/P for phones etc size 12 x 9 x 10" note these req ext P.U. Tech info on this & Rx supplied. £95. **RX ATU** Army type for use with R234 (R210) 2 to 27 Megs in 4 bands to match Long Wire or Whip size 9 x 7 x 8" with outer cover with circ etc. £35. **WATTMETERS** low pwr CT443 3 ranges 100/300 Mill/W & 1.5 watt 50 ohm to 1 Gz tested. £25. **PROBE UNIT** RF type demodulator now spec but good to VHF suitable for use with scope good quality unit made by Rh & Sw new. £12.50. For callers Qty of Hitachi CCTV Colour Cameras no lenses 12V DC portable type. £65 ea.

Above prices are inclusive, goods ex equipment unless stated new.
2 x 24p stamps for list 51.

A. H. SUPPLIES

Unit 12 Bankside Works,
Darnall Road, Sheffield S9 5HA
Phone: (0742) 444278

Receiving you in BEDFORD

For all your amateur and shortwave listening requirements

OPENING OFFERS

Lowe HF150 short wave receiver	£339.00
NRD 525 HF receiver	£779.00
Yaesu FRG100 HF receiver	£569.00
Fairmate HP2000 hand-held scanner	£279.00
AOR AR15000EX hand-held scanner	£329.00
Yupiteru MVT7100 hand-held scanner	£429.00

Limited offers only while stocks last - many other products available.

Whatever your interest - HF, VHF, UHF, transmit or receive.

Call now - (0234) 364004

PART EXCHANGE AND MAIL ORDER WELCOME



WELLAND COMMUNICATIONS

33, HIGH STREET, BEDFORD, MK40 1RY
FAX (0234) 364054

PETER RODMELL COMMUNICATIONS G3ZRS

BRITISH 'HAND-BUILT' LINEAR AMPLIFIERS

Using our famous Explorer/Hunter/Discovery designs we will provide amplifiers to your specifications with drive and output powers as required. Utilising Eimac 350Dz or 3CX300A7 valves the amplifiers are hand-built for use in Commercial/Professional/Medical and Amateur Radio applications.

Examples:

HF Hunter 500 (500 Watt)from £985 incl VAT

HF Explorer 1000 (1k Watt).....from £1,385 incl VAT

2m Discovery 800 (800 Watt) ..from £1,295 incl VAT

Amplifiers up to 10KW available for professional use.

COMPARE THESE BRITISH MADE AMPLIFIERS WITH THE JAPANESE AND AMERICAN EQUIVALENTS!!!

Ask about components for your amplifier project... valves, transformers and RF parts always on stock.

Contact Peter /G3ZRS and discuss your requirements.

'MOBILITE' MOBILE MICROPHONES

Prices from
£18.50 portables
and **£33.35** mobiles.

As requested our new portable features a true headset and electret mic with windguard.

- ★ Next day FREE Mail order service ★
 - ★ Call today for safe operating tomorrow ★
- Contact Peter G4EJP for further details.

From the originator of the Heathkit comes the next generation models to suit Kenwood 241/702/732/TN70/48, Alnico DR589/112/DJ560/180, Yaesu 290, 5200 and all current models. Choose from mobiles, portables and the new DIY kit.

Mobiles offer:

- ★ Xtal controlled tone burst ★ Voltage regulator
- ★ Variable audio gain ★ Variable tone burst gain
- ★ Easy maintenance with modular design ★ British made

Call/Fax **0964-550921**

FIELD HEAD, LECONFIELD ROAD, LECONFIELD, BEVERLEY NORTH HUMBERSIDE HU17 7LU
Next door to petrol station between Beverley and Leconfield on the A154, 1 mile north of Beverley

Bredhurst electronics



BREDHURST ELECTRONICS LTD.

High Street, Handcross, W. Sussex RH17 6BW
(0444) 400786 Fax (0444) 400604

ALL ITEMS AVAILABLE BY MAIL ORDER, PLEASE PHONE OR FAX YOUR REQUIREMENTS

AERIAL ACCESSORIES

	P&P	
50m 16SWG H/Drawn Copper Wire	£12.95	£3.50
Small Ceramic Egg Insulators	1.00	0.25
Polyprop insulators	0.75	0.25
T' piece Polyprop Dipole Centre	2.85	0.25
Deluxe Dipole Centre, 259 Socket	9.35	2.00
Self-Amalgamating Tape	4.95	1.00
300 R Slotted Feeder, per metre	0.58	0.10
450 R Slotted Feeder, per metre	0.50	0.10
Stranded 16 SWG H/D Wire, per metre	0.30	0.10
G5RV Full Size	20.95	3.50
G3RV Half Size	18.95	3.50
URM67 50R Low Loss Coax, per metre	0.95	0.25
URM76 50R Coax, per metre	0.40	0.10

SPIRO ANTENNA PRODUCTS

PB1	1:1 Balun 2kW P.E.P.	17.95	2.00
PB4	4:1 Balun 2kW P.E.P.	19.95	2.00
LC160	160 Mtr Antenna Shortener Pair	24.95	2.50
LC80	80 Mtr Antenna Shortener Pair	23.95	2.50
T15	21MHz Traps 1kW Pair	39.90	2.50
T20	14MHz Traps 1kW Pair	39.90	2.50
T40	7MHz Traps 1kW Pair	41.90	2.50
T80	3.5MHz Traps 1kW Pair	41.90	2.50

WIRE ANTENNAS

Any Wire Antenna can be made to your specifications, trap dipoles, wind oms, vee's, quad loops etc.
PHONE FOR DETAILS

PALOMAR



RX NOISE BRIDGE

The palomar R-X Noise Bridge tells you if your antenna is resonant or not and, if it is not, whether it is too long or too short. It gives resistance and reactance readings on dipoles, inverted Vees, quads, beams, multiband trap dipoles and verticals from 1 to 100 MHz.

£69.95

Carriage and packing charge
minimum £1.50 per order

GAPTECHNOLOGY

EAGLE DX VI

- Special Design for pole mounting
- No radial wires
- Operates on 40, 20, 17, 15, 12 & 10 metres
- Total length 21 feet

£289.95

CHALLENGER DX VI

- Operates on 80, 40, 20, 15, 12, 10, 6 & 2 metres
- Ground mounting, height 31 ft.

£269.95

VOYAGER DX IV

- Operates on 160, 80, 40 & 20 metres
- Ground mounting, height 45 ft.

£459.95

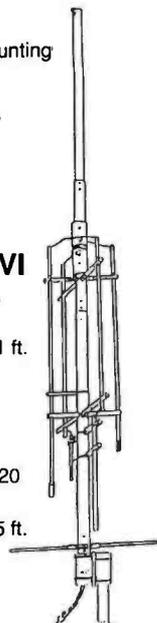

Phone for prices on Kenwood Icom Yaesu, and our wide range of accessories

BREDHURST ELECTRONICS LTD HIGH ST, HANDCROSS, W. SUSSEX RH17 6BW
Open Monday-Friday 9am-5.30pm Saturday 9.30am-4.30pm

The World of ATV

F O C A L P O I N T

This time, Andy Emmerson G8PTH has news about the Hastings ATV repeater, letters from readers and a telephone call from Portugal to tell you about.

This month I'm pleased to say that **Keith Ellis G8HGM** has generously responded to my plea for information on the 'secret' TV repeaters, and writes this 'tear-stained' letter about the Hastings (Sussex) repeater. "We are pleased to inform you that we do still exist, and apologise for not keeping you informed on progress. The original a.m. repeater, though usable, was taken out of service to improve the service area. The particular need was for good interdigital filters. Whilst waiting for these, a separate f.m. repeater was built and left running on dummy load, the plan being to apply for an f.m. licence".

Eighteen months later, and still minus filters, the repeater group was deliberately shocked out of apathy by throwing in the sponge! Keith continued: "At this stage, another member of the group undertook to build from scratch an a.m. transmitter, which he was commissioned to do, with the sword of Damocles poised over his head, for completion by May 1993, the renewal date of the licence. To date the transmitter is running at approximately 6W and a usable picture can be received in Eastbourne, approximately 12 miles away. *Vice versa*, a 6W transmitter in Eastbourne gives a good repeatable picture into Hastings".

Filters have now been made and progress towards a completed RMT1 repeater is steady but slow. Keith rounds off by saying, "A talk on ATV has been booked for the local club and there are several interested amateurs building downconverters."

Sleaford Reader

Nick Major G0HFL writes from Sleaford, Lincolnshire and says he really looks forward to reading this section in *PW*. Well, I always suspected I had at

least one satisfied reader! But he has a serious question as well. "I hope to set up a 24cm ATV station here and I would be interested to hear from any other stations who are already active on this mode". If you think you could work Sleaford, please write to Nick at his callbook address.

Bob Johnstone GM1YGV writes from Inverloch in Inverness, Highland Region on behalf of the Highland Amateur Television Group. They comprise Dave GM3WML, Dick GM8AZS, Bob GM1YGV, Donnie s.w.l., plus welcome assistance from Bill GM4LNH, other amateurs and family members.

So much for the prologue, now read on! "Please don't feel discouraged at the seeming lack of interest in your writing endeavours. Many people like myself are not what could be called prolific letter writers, yet we do like to read what you and others tell us. For many in less well populated areas, articles like yours are most useful. If your geography is good, you will have noticed that we come from a low population, mountainous area and therefore don't operate much ATV or (yet) much v.h.f. and up on other modes either.

"What my friends and I have done over the past couple of years, has been to build some 23cm ATV gear from kits, and to use it both locally and further afield for demonstrations to the public.

"This has been done from the top of Ben Nevis 4410ft high to the more low level (?) activity at for instance, the European Mountain Bike Championships (British Leg) at Aviemore, over a full two days. This meant transporting a mass of gear and setting it up so that the public could see what was going on, and so introducing them to amateur radio. This was a great exercise and



An informative test signal from the Dutch repeater PIGATE at Eelde, the Netherlands.

well thought-of by the public.

"Another similar in scope event, was the European Three Day Horse Trials Championship, at Blair Athol, Perthshire. We only operated for two of the days on this occasion and had a great surprise. At first we had P5 pictures on 23cm, P3/4 on 70cm, then as the dew dried out on the trees, which were quite high, our 23cm P5 died away to nothing, but increasing the 70cm picture to full P4.

"The only explanation that I can really imagine, is that the heavy dew on the treetops caused some form of ducting on 23cm. Afterwards we thought that perhaps it had been reflected signals that we had started with, but this does not seem quite right.

"Perhaps one day as we get better equipped, we shall take part in some contesting and work some, to us, DX. Perhaps even work you!"

So, thanks for the Highland news, Bob, keep writing to 'Focal Point'.

Call From Portugal

Recently I received a 'phone call from **CT1BRM** in Lisbon: they want to build an ATV repeater in Portugal. This was passed on the G8VPG of the Severnside Group, since they have one of the most technically

developed repeaters in Britain (no arguments please!). Let's hope something useful comes from this.

Jose Robat ON7TP, writes from Liege in Belgium to report that their ATVB group recently made a 25-minute instructional video showing how Jacques ON5EE made a 3-element Yagi antenna for the 144MHz band. Jose used his JVC GR-C1 camcorder together with a CG-P50 character generator, (also by JVC). Jose has also just finished the construction of the new TVRO receiver (CQ-TV 135) with the S-meter circuit from CQ-TV 142 and digital display from TV Amateur 63/1986.

Regular correspondent **Mike Sheffield ZL1ABS**, made it over from New Zealand to the BATC convention this year again and regaled us with tales of ATV operation there. He also left copies of details of 36 different p.c.b.s for television projects. These are of professional quality and quite moderately priced. An 11-page catalogue is available if you send me a cheque for £1 (To: **71 Falcutt Way, Northampton, NN2 8PH**).

That's all I've got room for this time so cheerio for now.

E N D

A R C A D E

The PW Shopping Arcade

Welcome to the *Practical Wireless* 'Arcade'. In this section of the magazine, you'll be able to find all those important services 'under one roof' - just like the shopping arcades you see in the High Street.

Let your eyes 'stroll through' the Arcade every month and you'll find all departments open for business including: The Book Service, PCB Service, Binders and details of other *PW* Services. Make a regular habit of 'visiting' the Arcade, because in future, you'll have the chance of seeing special book offers and other bargains. And don't forget, this Arcade is open wherever you're reading *PW*!

Services

Queries:

Practical Wireless,
PW Publishing Ltd., Arrowsmith Court,
Station Approach,
Broadstone, Dorset BH18 8PW.

We will always try to help readers having difficulties with *Practical Wireless* projects, but please note the following simple rules:

- 1: We **cannot** deal with technical queries over the telephone.
- 2: We **cannot** give advice on modifications either to our designs, to commercial radio, TV or electronic equipment.
- 3: All letters asking for advice **must** be accompanied by a stamped self-addressed envelope (or envelope plus IRCs for overseas readers).
- 4: Make sure you describe the problem adequately, with as much detail as you can possibly supply.
- 5: Only one problem per letter please.

Back Numbers

Limited stocks of many issues of *PW* for past years are available at £2.00 each including post and packing. If the issue you want is not available, we can photocopy a specific article at a cost of 85p per article or part of article.

Over the years, *PW* has reviewed many items of radio related equipment. A list of all the available reviews and their cost can be obtained from the Editorial Offices at Arrowsmith Court, Station Approach, Broadstone, Dorset BH18 8PW for a stamped self-addressed envelope.

Binders

PW can provide a choice of binders for readers' use. Plain blue binders are available, each holding 12 issues of any A4 format magazine. Alternatively, blue binders embossed with the *PW* logo in silver can be supplied. The price for either type of binder is £5.50 each (£1 p&p for one, £2 for two or more). Send all orders to PW Publishing Ltd., FREEPOST, Arrowsmith Court, Station Approach, Broadstone, Dorset BH18 8PW.

Constructional Projects

Components for *PW* projects are usually readily available from component suppliers. For unusual or specialised components, a source or sources will be quoted. Each constructional project is given a rating to guide readers as to the complexity.

Beginner: A project that can be tackled by a beginner who is able to identify components and handle a soldering iron.

Intermediate: A fair degree of experience of building radio or electronic projects is assumed, but only basic test equipment will be needed to complete any tests and adjustments.

Advanced: A project likely to appeal to the experienced constructor. Access to workshop facilities and test equipment will often be required. Definitely not for the beginner to attempt without assistance.

Mail Order

All items from *PW* are available Mail Order, either by post or using the 24hr Mail Order Hotline (0202) 659930. Payment should be by cheque, postal order, money order or credit card (Mastercard and Visa only). All payments **must** be in sterling and overseas orders **must** be drawn on a London Clearing Bank.

PW PCB Service

Enquiries, orders and remittances should be sent to:

Badger Boards, 87 Blackberry Lane, Four Oaks, Sutton Coldfield B74 4JF. Tel: 021-353 9326, marking your envelope PW PCB Service. Cheques should be crossed and made payable to **Badger Boards**. When ordering please state the article title as well as the board number. Please print your name and address clearly in block capitals and do not enclose any other correspondence with your order.

We have talked to Badger Boards about the club and group discount on orders, and they are happy to continue this service. Club secretaries and group leaders should contact Badger Boards direct for the new discount rates. Please allow 28 days for delivery.

We have talked to Badger Boards about the club and group discount on orders, and they are happy to continue this service. Club secretaries and group leaders should contact Badger Boards direct for the new discount rates. Please allow 28 days for delivery.

Board	Article (Project) Title	Issue
WR315	PW Bourbon 3.5MHz TX	Aug 93
WR314	UHF Pre-Amplifier	Dec 92
WR313	10MHz Transmitter	Nov 92
WR312	Receive/Mixer (Getting Started)	Nov 92
WR311	Oscillator BFO (Getting Started)	Sept 92
WR310	1.2GHz Pre-scaler	Aug 92
WR309	Volt Reg/Divide by 100	Aug 92
WR308	TTL 1MHz Oscillator (Getting Started)	July 92
WR307	Crystal Checker (Getting Started)	June 92
SET	WR303/304/305/306	Apr 92
	Inductance Bridge	
WR302	GDO (Getting Started)	Apr 92
WR301	Challenger Receiver	Feb 92
WR300a	OSCAMPI Oscillator	Mar 92
WR300	OSCAMPI Amplifier	Feb 92
WR299	Multivibrator (Getting Started)	Jan 92
WR297/298	Additional Beaver boards	
SET	WR295/296 PW Beaver	Oct 91
SET	WR292/293/294 Chatterbox	Aug 91
SET	WR290/291 Robin Freq. Counter	Aug 91
SET	WR292/293/294 Chatterbox	Aug 91
WR289	Meon-4 (Control)	Jul 91
WR288	Morse Master	Jun 91
WR286	Meon-4 (RF PA)	Jun 91
WR287	Morse (Speedbrush)	May 91
WR255	Meon-4	May 91
WR285	Scope Probe PSU	Apr 91
WR284	Scope Probe	Apr 91
WR283	Sudden Receiver	Mar 91
WR282	Repeater Toneburst	Feb 91
WR281	High Voltage PSU	Jan 91
SET	WR263/264 +WR276-80	Jul 90
	Marland Transmitter	Sep 90
WR272	NiCad Recycler	Jun 90
WR275	Low Voltage Alarm	Jun 90
WR273	Valve PSU	May 90
WR274	RX Attenuator	May 90
WR271	Product Detector	Apr 90
WR270	Badger Cub	Apr 90
WR269	Glynne	Feb 90
WR268	Irwell (RF PA)	Feb 90
WR264	Irwell (Relay)	Feb 90
WR263	Irwell (VFO)	Jan 90
WR267	PW 49'er	Jan 90
WR266	Tuned Active Antenna	Jan 90
WR265	Tuned Active Antenna (PSU)	Jan 90
WR199	Meon 50MHz Transverter	Oct 85
WR161	Marchwood 12V 30A PSU	Jul 83

CALL BADGER BOARDS ON 021-353 9326 FOR UP-TO-DATE PRICES

Please use the order form on page 65 for all items in the *PW* arcade.

B O O K S

The books listed have been selected as being of special interest to our readers. They are supplied direct to your door. Some titles are overseas in origin.

HOW TO ORDER. PLEASE USE THE ORDER FORM ON PAGE 65.

POST AND PACKING; add £1.00 for one book, £2.00 for two or more books, orders over £40 post and packing free, (overseas readers add £1.75 for one book, £3.50 for two or more for surface mail postage) and send a postal order, cheque or international money with your order to **PW Publishing Ltd, FREEPOST, Arrowsmith Court, Broadstone, Dorset BH18 8PW.** Please make your cheques payable to PW Publishing Ltd. Payment by Access, Mastercard, Eurocard or Visa also accepted on telephone orders to Poole (0202) 659930. Books are normally despatched by return of post but please allow 28 days for delivery. Prices correct at time of going to press. Please note: all payments must be made in Sterling.

LISTENING GUIDES

AIR BAND RADIO HANDBOOK

(4th Edition)
David J. Smith
Extensively revised & updated (October 1992). Air band radio listening enables you to listen-in on the conversations between aircraft and those on the ground who control them, and is an increasingly popular and fascinating hobby. A new chapter on military air band has been added. The author, an air traffic controller, explains more about this listening hobby. 190 pages. £7.99

DIAL SEARCH 1992/94

George Wilcox
The listener's check list and guide to European radio broadcasting. Covers m.w., l.w., v.h.f. & s.w., including two special fold-out maps. Also includes a full list of British stations, a select list of European station, broadcasts in English and 'Making the Most of Your Portable'. 46 pages. £4.25

FLIGHT ROUTINGS 1993

Compiled by T.T. & S.J. Williams
This guide was produced with the sole aim of assisting airband listeners to quickly find details of a flight, once they have identified an aircraft's callsign. Identifies the flights of airlines, schedule, charter, cargo and mail, to and from the UK and Eire and overflights between Europe and America. 122 pages. £5.95

GUIDE TO FACSIMILE STATIONS

12th Edition
Joerg Klingenfuss
This manual is the basic reference book for everyone interested in FAX. Frequency, callsign, station name, ITU country/geographical symbol, technical parameters of the emission are all listed. All frequencies have been measured to the nearest 100Hz. Included are 300 sample charts and their interpretation. 416 pages. £18.00

GUIDE TO UTILITY STATIONS 11th Edition

Joerg Klingenfuss
This book covers the complete short wave range from 3 to 30MHz together with the adjacent frequency bands from 0 to 150kHz and from 1.6 to 3MHz. It includes details on all types of utility stations including FAX and RTTY. There are 19549 entries in the frequency list and 3590 in the alphabetical callsign list plus press services and meteorological stations. Included are RTTY & FAX press and meteo schedules. There are 11800 changes since the 10th edition. 534 pages. £24.00

HF OCEANIC AIRBAND COMMUNICATIONS 4th Edition

Bill Laver
HF aircraft channels by frequency and band, main ground radio stations, European R/T networks and North Atlantic control frequencies. 31 pages. £3.95

INTERNATIONAL RADIO STATIONS GUIDE BP25

Peter Shore
As in 'Broadcast Roundup', his column in *PW*, Peter Shore has laid this book out in world areas, providing the listener with a reference work designed to guide around the ever-more complex radio bands. There are sections covering English language transmissions, programmes for DXers and s.w.l.s. Along with sections on

European medium wave and UK f.m. stations. 266 pages. £5.95

INTERNATIONAL VHF FM GUIDE (THE) 7th Edition.

Julian Baldwin G3UHK & Kris Partridge G8AUU
This book gives concise details of repeaters & beacons world-wide plus coverage maps & further information on UK repeaters. 70 pages. £2.85

MARINE UK RADIO FREQUENCY GUIDE

Bill Laver
A complete guide (reprinted January 1993) to the UK s.w. and v.h.f. marine radio networks. Useful information, frequency listings and the World Marine Coastal Phone Stations. 62 pages. £4.95

NEWNES SHORT WAVE LISTENING HAND BOOK

Joe Pritchard G1UQW
A technical guide for all short wave listeners. Covers construction and use of sets for the s.w.l. who wants to explore the bands up to 30MHz. Also covers the technical side of the hobby from simple electrical principles all the way to simple receivers. 276 pages. £15.95

POCKET GUIDE TO RTTY AND FAX STATIONS (THE)

Bill Laver
A handy reference book listing RTTY and FAX stations, together with modes and other essential information. The listing is in ascending frequency order, from 1.6 to 26.8MHz. 57 pages. £3.95

RADIO LISTENERS GUIDE 1993

Clive Woodyear
This is the third edition of this radio listener's guide. Simple-to-use maps and charts show the frequencies for radio stations in the UK. Organised so that the various station types are listed separately, the maps are useful for the travelling listener. Articles included in the guide discuss v.h.f. aeriels, RDS, the Radio Authority and developments from Blaupunkt. 56 pages. £2.95

SHORT WAVE INTERNATIONAL FREQUENCY HANDBOOK

Formerly the Confidential Frequency List and re-published in April 93, this book covers 500kHz-30MHz. It contains duplex and channel lists, callsigns, times and modes, broadcast listing and times. 192 pages. £9.95

SDUNDS EASY The complete guide to Britain's radio stations

Compiled by Ken Davies
A guide to the numerous local radio stations throughout the UK. If you do a lot of travelling this book is invaluable. Itemised by areas, it makes finding your kind of sounds easy. 52 pages. £2.95

VHF/UHF AIRBAND FREQUENCY GUIDE 4th Edition

A complete guide to civil & military airband frequencies including how to receive the signals, the frequencies and services. VOLMET, receiver requirements, aeriels and much more about the interesting subject of airband radio are included. 123 pages. £6.95

VHF/UHF SCANNING FREQUENCY GUIDE (THE)

This book gives details of frequencies from 26MHz to 12GHz with no gaps

and who uses what. Completely revised and enlarged (February 1993), there are chapters on equipment requirements as well as antennas, the aeronautical bands, as well as the legal aspect of listening using a scanner. 156 pages. £9.95

WORLD RADIO TV HANDBOOK 1993

Country-by-country listing of l.w., m.w. & s.w. broadcast and TV stations. Receiver test reports, English language broadcasts. The s.w.l.s 'bible'. £15.95.

ANTENNAS (AERIALS)

AERIAL PROJECTS BP105

Practical designs including active, loop and ferrite antennas plus accessory units. 96 pages. £2.50

ANTENNA EXPERIMENTER'S GUIDE (THE)

Peter Dodd G3LDO
Although written for radio amateurs, this book will be of interest to anyone who enjoys experimenting with antennas. You only need a very basic knowledge of radio & electronics to get the most from this book. Chapters include details on measuring resonance, impedance, field strength and performance, mats and materials and experimental antennas. 200 pages. £9.90

ANTENNA IMPEDANCE MATCHING

Wilfred N. Caron
Proper impedance matching of an antenna to a transmission line is of concern to antenna engineers and to every radio amateur. A properly matched antenna as the termination for a line minimises feed-line losses. Power can be fed to such a line without the need for a matching network at the line input. There is no mystique involved in designing even the most complex multi-element networks for broadband coverage. 195 pages. £11.95

ARRL ANTENNA BOOK (THE)

16th Edition
A station is only as effective as its antenna system. This book covers propagation, practical constructional details of almost every type of antenna, test equipment and formulas and programs for beam heading calculations. 789 pages. £14.50

ARRL ANTENNA COMPENDIUM (THE) Volume One

Fascinating and hitherto unpublished material. Among the topics discussed are quads and loops, log periodic arrays, beam and multi-band antennas, verticals and reduced size antennas. 175 pages. £9.50

ARRL ANTENNA COMPENDIUM (THE) Volume Two

Because antennas are a topic of great interest among radio amateurs, ARRL HQ continues to receive many more papers on the subject than can possibly be published in *QST*. Those papers are collected in this volume. 208 pages. £9.50

ARRL ANTENNA COMPENDIUM (THE) Volume Three

Edited by Jerry Hall K1TD
As the title suggests, this book is the third in the continuing series on practical antennas, theory and accessories produced by the ARRL. The book reflects the tremendous

interest and activity in antenna work, and provides a further selection of antennas and related projects you can build. 236 pages. £9.50

BEAM ANTENNA HANDBOOK

W. I. Orr W6SAI & S. D. Cowan W2LX
Design, construction, adjustment and installation of h.f. beam antennas. The information this book contains has been compiled from the data obtained in experiments conducted by the authors, and from information provided by scientists and engineers working on commercial and military antenna ranges. 268 pages. £7.50

G-QRP CLUB ANTENNA HANDBOOK (THE)

Compiled and edited by P. Linsley G3PDL & T. Nicholson K4SWR/GWOLNQ
This book is a collection of antenna and related circuits taken from *Sprat*, the G-QRP Club's journal. Although most of the circuits are aimed at the low-power fraternity, many of the interesting projects are also useful for general use. Not intended as a text book, but offers practical and proven circuits. 155 pages. £5.00

HF ANTENNA COLLECTION (RSGB)

Edited by Erwin David G4LQI
This book contains a collection of useful, and interesting h.f. antenna articles, first published in the RSGB's *Radio Communication* magazine, between 1968 and 1989, along with other useful information on ancillary topics such as feeders, tuners, baluns, testing and mechanics for the antenna builder. 233 pages. £9.50.

INTRODUCTION TO ANTENNA THEORY (AN) BP198

H. C. Wright
This book deals with the basic concepts relevant to receiving and transmitting antennas, with emphasis on the mechanics and minimal use of mathematics. Lots of diagrams help with the understanding of the subjects dealt with. Chapters include information on efficiency, impedance, parasitic elements and a variety of different antennas. 86 pages. £2.95

NOVICE ANTENNA NOTEBOOK

Doug DeMaw W1FB
Another book from the pen of W1FB, this time offering "new ideas for beginning hams". All the drawings are large and clear and each chapter ends with a glossary of terms. It is written in plain language and you don't need to be a mathematician to build and erect the support structures that are presented in this book. 124 pages. £6.95

PRACTICAL ANTENNA HANDBOOK

Joseph J. Carr
As the name suggests, this book offers a practical guide to everything to do with antennas, from h.f. to microwaves. It also has sections on propagation, transmission lines, antenna fundamentals and a helpful introduction to radio broadcasting and communication. The book neatly balances a practical approach with the minimum of mathematics, good diagrams and a lively text. 437 pages. £20.95

SIMPLE, LOW-COST WIRE ANTENNAS FOR RADIO AMATEURS

W. I. Orr W6SAI & S. D. Cowan W2LX

Efficient antennas for Top Band to 2m, including 'invisible' antennas for difficult station locations. Clear explanations of resonance, radiation resistance, impedance, s.w.r., balanced and unbalanced antennas are also included. 188 pages. £7.50

W1FB'S ANTENNA NOTEBOOK

Doug DeMaw W1FB
This book provides lots of designs, in simple and easy to read terms, for simple wire and tubing antennas. All drawings are large and clear making construction much easier. There is no high-level mathematics in this book, just simple equations only when necessary to calculate the length of an antenna element or its matching section. 123 pages. £6.95

WIRES & WAVES

Collected Antenna Articles from PW 1980-1984
Antenna and propagation theory, including NBS Yagi design data. Practical designs for antennas from medium waves to microwaves, plus accessories such as a t.u.s. s.w.r. and power meters and a noise bridge. Dealing with TVI is also covered. 160 pages. £3.00

YAGI ANTENNA DESIGN

Dr James L. Lawson W2PVP
This book is a polished and expanded version of a series of articles first published in *Ham Radio* following on from a series of lectures by the author, who was well-known as the expert on Yagi design. Chapters include simple Yagi antennas, loop antennas, effect of ground, stacking and practical antenna design. 210 pages. £10.95

25 SIMPLE AMATEUR BAND AERIALS BP125

E. M. Noll
How to build 25 simple and inexpensive amateur band aeriels, from a simple dipole through beam and triangle designs to a mini-rhombic. Dimensions for specific spot frequencies including the WARC bands are also given. 63 pages. £1.95

25 SIMPLE INDOOR AND WINDOW AERIALS BP136

E. M. Noll
Designs for people who live in flats or have no gardens, etc., giving surprisingly good results considering their limited dimensions. Information is also given on short wave bands, aerial directivity, time zones and dimensions. 50 pages. £1.75

25 SIMPLE SHORT WAVE BROADCAST BAND AERIALS BP132

E. M. Noll
Designs for 25 different short wave broadcast band aeriels, from a simple dipole through helical designs to a multi-band umbrella. Information is also given on short wave bands, aerial directivity, time zones and dimension tables that will help spot an aerial on a particular frequency. 63 pages. £1.95

25 SIMPLE TROPICAL AND MW BAND AERIALS BP145

E. M. Noll
Simple and inexpensive aeriels for the broadcast bands from medium wave to 49m. Information is also given on band details, directivity, time zones and dimensions. 54 pages. £1.75

E R V I C E

MORSE

INTRODUCING MORSE

Collected Articles from PW 1982-1985
Ways of learning the Morse Code, followed by constructional details of a variety of keys including Iambic, Triambic and an Electronic Bug with a 528-bit memory as well as a practice oscillator and Morse tutor.
48 pages. £1.25

SECRET OF LEARNING MORSE CODE (THE)

Mark Francis
Updates for the Novice Licence. Designed to make you proficient in Morse code in the shortest possible time, this book points out many of the pitfalls that beset the student.
84 pages. £4.95

SATELLITES

NEWNES GUIDE TO SATELLITE TV

Derek Stephenson
This book, the 2nd edition, is a hard bound volume, printed on high quality paper. The author is a satellite repair and installation engineer and the book covers all information needed by the installation engineer, the hobbyist and the service engineer to understand the theoretical and practical aspects of satellite reception with dish installation and how to trouble-shoot when picture quality is not up to anticipated reception. Mathematics has been kept to a minimum.
284 pages. £17.95

SATELLITE BOOK (THE) - A complete guide to satellite TV theory and practice

John Breeds
This book deals almost exclusively with television broadcast satellites and is a comprehensive collection of chapters on topics, each written by an expert in that field. It appears to be aimed at the professional satellite system installer, for whom it is invaluable, but it will be appreciated by a much wider audience - anyone interested in satellite technology.
280 pages. £30.00

SATELLITE EXPERIMENTER'S HANDBOOK (THE) 2nd Edition

Martin Davidoff K2UBC
The book is divided into four main sections - History, Getting Started, Technical Topics and Appendices. It provides information on spacecraft built by, and for, radio amateurs. In addition, it discusses weather, TV-broadcast and other satellites of interest to amateurs.
313 pages. £14.50

SATELLITE TELEVISION A layman's guide

Peter Pearson
Pictures from space, that's what satellite television is all about. Orbiting satellites, 35000km high, receive TV signals from stations on the earth and re-transmit them back again. This book explains all you need to know to set up your own satellite TV terminal at home, dish and accessories, cable and tuner.
73 pages. £1.00

SATELLITE TELEVISION INSTALLATION GUIDE 2nd Ed

John Breeds
A practical guide to satellite television. Detailed guide-lines on installing and aligning dishes based on practical experience.
56 pages. £13.00

WEATHER SATELLITE HANDBOOK

4th edition
Dr Ralph E. Taggart WB8DQT
This book explains all about weather satellites, how they work and how you can receive and decode their signals to provide the fascinating pictures of the world's weather. Plenty of circuit diagrams and satellite predicting programs.
192 pages. £14.50

AMATEUR RADIO

ALL ABOUT VHF AMATEUR RADIO

W. I. Orr W6SAI
Written in non-technical language, this book provides information covering important aspects of v.h.f. radio and tells you where you can find additional data. If you have a scanner,

you'll find a lot of interesting signals in the huge span of frequencies covered, 100-300MHz & 50, 420, 902 & 1250MHz bands. 163 pages. £9.50.

AMATEUR RADIO CALL BOOK (RSGB)

1993 Edition
Over 60000 call signs are listed including EI stations. Now incorporates a 122-page section of useful information for amateur radio enthusiasts and a new novice call sign section.
444 pages. £9.50

ARRL HANDBOOK FOR RADIO AMATEURS (THE) 1993

This is the 70th edition of this handbook and contains the best information from previous issues. New for this edition is some information on feedback-loop design for power supplies, a new gel-cell charger project, updates on antenna systems and new coverage of baluns, propagation programs are compared and colour SSVT and telephone FAX machines are also covered. Finally there's a new section on 'for the workbench' with new projects for the reader to build.
1214 pages. £18.95

ARRL OPERATING MANUAL (THE)

Another very useful ARRL book. Although written for the American amateur, this book will also be of use and interest to the UK amateur. Topics covered range from short wave listening through operating awards to repeaters, operating and satellites.
684 pages. £12.95

ARRL SATELLITE ANTHOLOGY (THE)

The best from the Amateur Satellite News column and articles out of 31 issues of QST have been gathered together in this book. The latest information on OSCARs 9 through 13 as well as the RS satellites is included. Operation on Phase 3 satellites (OSCAR 10 and 13) is covered in detail.
97 pages. £5.95

ARRL UHF/MICROWAVE EXPERIMENTER'S MANUAL (THE)

Various Authors
A truly excellent manual for the keen microwave enthusiast and for the budding 'microwaver'. With contributions from over 20 specialist authors. Chapters covering techniques, theory, projects, methods and mathematics.
446 pages. £14.50

COMPLETE OX'ER (THE) CD

Bob Locher
This book covers equipment and operating techniques for the DX chaser, from beginner to advanced. Every significant aspect of DXing is covered, from learning how to really listen, how to snatch the rare ones out of the pile-ups and how to secure that elusive QSL card.
204 pages. £7.95

HINTS AND KINKS FOR THE RADIO AMATEUR

Edited by Charles L. Hutchinson and David Newkirk
A collection of practical ideas gleaned from the pages of QST magazine. Plenty of projects to build, hints and tips on interference, c.w. and operating and snippets of information from amateurs who've tried and tested the idea.
129 pages. £4.95

HOW TO PASS THE RADIO AMATEURS' EXAMINATION (RSGB)

Clive Smith G4FZH and George Benbow G3HB
The background to multiple choice exams and how to study for them with sample RAE paper for practice plus maths revision and how to study for the exam. The majority of this book is given to sample examination papers so that candidates can familiarise themselves with the examination and assess their ability.
88 pages. £6.70.

INTRODUCTION TO AMATEUR COMMUNICATIONS SATELLITES (AN)

BP290. A. Pickard
This book describes several currently available systems, their connection to an appropriate computer and how they can be operated with suitable software. The results of decoding signals containing such information

as telemetry data and weather pictures are demonstrated.
102 pages. £3.95

INTRODUCTION TO AMATEUR RADIO (AN) BP257

I. D. Poole
This book gives the newcomer a comprehensive and easy to understand guide through amateur radio. Topics include operating procedures, jargon, propagation and setting up a station.
150 pages. £3.50

INTRODUCTION TO RADIO WAVE PROPAGATION (AN) BP293

J.G. Lee
How does the sun and sunspots affect the propagation of the radio waves which are the basis of our hobby? They affect the ionosphere, but differing frequencies are treated differently. Find out how to use charts to predict frequencies that will be the most profitable. What effect will noise have on the signal? Find out with this book.
116 pages. £3.95

INTRODUCTION TO VHF/UHF FOR RADIO AMATEURS (AN) BP281

I.D. Poole
An excellent book to go with the new Novice or full call sign. Nine chapters and an appendix deal with all aspects and frequencies from 50 to 1300MHz. Topics include propagation, descriptions of the bands, antennas, receivers, transmitters and a special chapter on scanners.
102 pages. £3.50

PASSPORT TO AMATEUR RADIO

Reprinted from PW 1981-1982
The famous series by GW3JGA, used by thousands of successful RAE candidates in their studies. Plus other useful articles for RAE students including emission codes, explanations of diodes, s.s.b. and decibels.
87 pages. £1.50

PRACTICAL GUIDE TO PACKET OPERATION IN THE UK

Mike Mansfield G6AWD
Introduces the concept of packet radio to the beginner. Problem areas are discussed and suggestions made for solutions to minimise them. Deals with the technical aspects of packet taking the reader through setting up and provides a comprehensive guide to essential reference material.
205 pages. £8.95

QRP CLASSICS

Edited by Bob Schetgen
Operating QRP is fun. The equipment is generally simple and easy to build, but often performs like more sophisticated commercial equipment. Some QRP Field Day stations operate a full 27 hours on a car battery - it's the perfect equipment for emergency communication when the power fails. Extracts from QST and the ARRL Handbook.
274 pages. £9.95

RADIO AMATEUR CALLBOOK INTERNATIONAL LISTINGS 1993 71st Edition

The only publication listing licensed radio amateurs throughout the world. Also includes DXCC Countries list, standard time chart, beacon lists and much more.
Over 1400 pages. £19.50

RADIO AMATEUR CALLBOOK NORTH AMERICAN LISTINGS 1993 71st Edition

Listings of US amateurs (including Hawaii). Also contains standard time chart, census of amateur licences of the world, world-wide QSL bureau, etc. Over 1400 pages. £19.50

RADIO AMATEUR'S QUESTIONS & ANSWER REFERENCE MANUAL (THE) 4th Edition.

R. E. G. Petri G8CCJ
This book has been compiled especially for students of the City and Guilds of London Institute RAE. It is structured with carefully selected multiple choice questions, to progress with any recognised course of instruction, although it is not intended as a text book.
280 pages. £7.95

RAE MANUAL (THE) RSGB

G.L. Benbow G3HB
The latest edition of the standard aid to studying for the Radio Amateurs' Examination. Updated to cover the latest revisions to the syllabus. Takes the candidate step-by-step through the course.
127 pages. £6.70

RAE REVISION NOTES

George Benbow G3HB
If you're studying for the Radio Amateurs' Examination, this book could be useful. It's a summary of the salient points of the *Radio Amateurs' Examination Manual*, the standard textbook for the exam. It's A5 size and therefore can be carried with you wherever you go. Easy-to-read, it's divided into 13 chapters with topics like receivers, power supplies, measurements, operating procedures, licence conditions and a summary of the formulae all dealt with.
92 pages. £4.00

VHF/UHF DX BOOK (THE)

Edited Ian White G3SEK
An all round source of inspiration for the v.h.f./u.h.f. enthusiast. Written by acknowledged experts this book covers just about everything you need to know about the technicalities of v.h.f./u.h.f. operating.
270 pages. £18.00

W1FB'S DESIGN NOTEBOOK

Doug DeMaw W1FB
This book is aimed at the non-technical amateur who wants to build simple projects and obtain a basic understanding of amateur electronics. Your workshop does not need to be equipped like an engineering lab to be successful as an experimenter. Don't let a lack of test equipment keep you from enjoying the thrills of experimentation.
195 pages. £8.50

W1FB'S HELP FOR NEW HAMS

Doug DeMaw W1FB
This book covers everything from getting acquainted with new equipment to constructing antennas, station layout, interference and operating problems to on-the-air conduct and procedures.
155 pages. £6.95

W1FB'S QRP NOTEBOOK

2nd Edition
Doug DeMaw W1FB
The new improved and updated 2nd edition of this book, covers the introduction to QRP, construction methods, receivers and transmitters for QRP. This workshop-notebook style publication, which is packed with new designs for the keen QRP operator, also covers techniques, accessories and has a small technical reference section.
175 pages. £7.95

YOUR GATEWAY TO PACKET RADIO

Stan Horzepa WA1LOU
What is packet radio good for and what uses does it have for the 'average' amateur? What are protocols? Where, why, when? Lots of the most asked questions are answered in this useful book. It included details of networking and space communications using packet.
278 pages. £8.95

THEORY

ARRL ELECTRONICS DATA BOOK (THE)

Doug DeMaw W1FB
Back by popular demand, completely revised and expanded, this is a handy reference book for the r.f. designer, technician, amateur and experimenter. Topics include components and materials, inductors and transformers, networks & filters, digital basics and antennas and transmission lines.
260 pages. £8.95

AUDIO (Elements of electronics - book 6) BP111

F. A. Wilson
This book studies sound and hearing, and examines the operation of microphones, loudspeakers, amplifiers, oscillators, and both disk and magnetic recording. Intended to give the reader a good understanding

of the subject without getting involved in the more complicated theory and mathematics.
308 pages. £3.95

BEGINNERS GUIDE TO MODERN ELECTRONIC COMPONENTS (A)

BP285. R.A. Penfold
This book covers a wide range of modern components. The basic functions of the components are described, but this is not a book on electronic theory and does not assume the reader has an in-depth knowledge of electronics. It is concerned with practical aspects such as colour codes, deciphering code numbers and the suitability.
166 pages. £3.95

EVERYDAY ELECTRONICS DATA BOOK

Mike Tooley BA
This book is an invaluable source of information of everyday relevance in the world of electronics. It contains not only sections which deal with the essential theory of electronic circuits, but it also deals with a wide range of practical electronic applications.
250 pages. £8.95

FILTER HANDBOOK A practical design guide

Stefan Niewiadomski
A practical book, describing the design process as applied to filters of all types. Includes practical examples and BASIC programs. Topics include passive and active filters, worked examples of filter design, switched capacitor and switched resistor filters and includes a comprehensive catalogue of pre-calculated tables.
195 pages. £30.00

FROM ATOMS TO AMPERES BP254

F.A. Wilson
Explains in simple terms the absolute fundamentals behind electricity and electronics. Topics include the use of SI units, gravity, magnetism, light, the electron, conduction in solids and electrical generators.
244 pages. £3.50

NEWNES PRACTICAL RF HANDBOOK

Ian Hickman
This book provides an easy-to-read introduction to modern r.f. circuit design. It's aimed at those learning to design r.f. circuitry and users of r.f. equipment such as signal generators and sweepers, spectrum and network analysers.
320 pages. £16.95

PRACTICAL ELECTRONICS CALCULATIONS AND FORMULAE

BP53. F. A. Wilson
This has been written as a workshop manual for the electronics enthusiast. There is a strong practical bias and higher mathematics have been avoided where possible.
249 pages. £3.95

REFLECTIONS Transmission Lines & Antennas

M. Walter Maxwell W2DU
This will help dispel the half-truths and outright myths that many people believe are true about transmission lines, standing waves, antenna matching, reflected power and antenna tuners.
323 pages. £14.50

SOLID STATE DESIGN FOR THE RADIO AMATEUR

Les Hayward W7Z01 and Doug DeMaw W1FB
Back in print by popular demand! A revised and corrected edition of this useful reference book covering all aspects of solid-state design. Topics include transmitter design, power amplifiers and matching networks, receiver design, test equipment and portable gear.
256 pages. £10.95

TRANSMISSION LINE TRANSFORMERS

Jerry Sevick W2FMI
This is the second edition of this book, which covers a most intriguing and confusing area of the hobby. It should enable anyone with a modicum of skill to make a balun, etc. Topics include analysis, characterisation, transformer parameters, baluns, multimatch transformers and simple test equipment.
270 pages. 0/P

BOOKS

RADIO

AIR & METEO CODE MANUAL

12th Edition
Joerg Klengenfuss
Detailed descriptions of the World Meteorological Organisation Global Telecommunication System operating FAX and RTTY meteo stations, and its message format with decoding examples. Also detailed description of the Aeronautical Fixed Telecommunication Network amongst others. 358 pages. £18.00

HIGH POWER WIRELESS EQUIPMENT

Articles from *Practical Electricity* 1910-11
Edited by Henry Walter Young
A reprint of interesting practical articles from the very early days of radio, when materials and methods described are from another era. Subjects covered ranges from aerials through detectors to things like Tesla and his wireless age. 99 pages. £7.70

MARINE SSB OPERATION

J. Michael Gale
How do you stay in touch when you sail off over the horizon and into the blue? What you need is a single sideband radio, a marine s.s.b. This book explains how the system works, how to choose and install your set and how to get the best out of it. There is also a chapter on amateur radio with the emphasis on the increasingly important maritime mobile nets. 96 pages. £9.95

MARINE VHF OPERATION

Michael Gale
A v.h.f. radiotelephone is essential equipment for any sea-going boat, but what can you do with it? Who can you call, and how do you make contact? Which channel do you use, and why? What is the procedure for calling another boat, calling the family through the telephone system, or making a distress call? This book will tell you. 47 pages. £6.95.

PASSPORT TO WORLD BAND RADIO

1993
This book gives you the information to explore and enjoy the world of broadcast band listening. It includes features on different international radio stations, receiver reviews and advice as well as the hours and language of broadcast stations by frequency. The 'blue pages' provide a channel-to-channel guide to world band schedules. 416 pages. £14.50.

RADIOTELETYPE CODE MANUAL

12th Edition
Joerg Klengenfuss
This book gives detailed descriptions of the characteristics of telegraph transmission on short waves, with all commercial modulation types including voice frequency telegraphy and comprehensive information on all RTTY systems and c.w. alphabets. 96 pages. £11.00

SCANNERS (Third Edition)

Peter Rouse GU1DKD
A guide for users of scanning receivers, covering hardware, antennas, accessories, frequency allocations and operating procedures. 245 pages. 0/P

SCANNERS 2

Peter Rouse GU1DKD
The companion to *Scanners*, this provides even more information on the use of the v.h.f. and u.h.f. communications band and gives constructional details for accessories to improve the performance of scanning equipment. 261 pages. £10.95

SHORT WAVE COMMUNICATIONS

Peter Rouse GU1DKD
Covers a very wide area and so provides an ideal introduction to the

hobby of radio communications. International frequency listings for aviation, marine, military, space launches, search and rescue, etc. Chapters on basic radio propagation, how to work your radio and what the controls do, antennas and band plans. 187 pages. £8.95

SHORT WAVE RADIO LISTENERS' HANDBOOK

Arthur Miller
In easy-to-read, non-technical language, the author guides the reader through the mysteries of amateur, broadcast and CB transmissions. Topics cover equipment needed, identification of stations heard & the peculiarities of the various bands. 207 pages. £7.99

WORLDWIDE HF RADIO HANDBOOK

Martyn R. Cooke
This book lists high frequencies used by aircraft and aeronautical ground stations. Divided into sections, Military, Civil, etc. The book should be easy to use. 124 pages. £6.95

WRTH EQUIPMENT BUYERS GUIDE

1993 Edition
Willem Bos & Jonathan Marks
A complete and objective buyer's guide to the current short wave receiver market. For the novice and the experienced listener, this guide explains how to make sense of the specifications and select the right radio for your listening needs. 270 pages. £15.95

1934 OFFICIAL SHORT WAVE RADIO MANUAL

Edited by Hugo Gernsback
A fascinating reprint from a bygone age with a directory of all the 1934 s.w. receivers, servicing information, constructional projects, circuits and ideas on building vintage radio sets with modern parts. 260 pages. £11.60

BEGINNERS

BEGINNER'S GUIDE TO RADIO 9th Edition

Gordon J. King
The book takes you in logical steps from the theory of electricity and magnetism to the sound you hear from the loudspeaker. Radio signals, transmitters, receivers, antennas, components, valves & semi-conductors, CB & amateur radio are all dealt with. 266 pages. £14.95

ELECTRONICS SIMPLIFIED - CRYSTAL SET CONSTRUCTION BP92

F. A. Wilson
Especially written for those who wish to take part in basic radio building. All the sets in the book are old designs updated with modern components. It is designed for all ages upwards from the day when one can read intelligently and handle simple tools. 72 pages. £1.75

INTERFERENCE

INTERFERENCE HANDBOOK (USA)

William R. Nelson WA6FOG
How to locate & cure r.f.i. for radio amateurs, CBers, TV & stereo owners. Types of interference covered are spark discharge, electrostatic, power line many 'cures' are suggested. 250 pages. £9.50

DATA REFERENCE

NEWNES AUDIO & HI-FI ENGINEER'S POCKET BOOK

Vivian Capel
This is a concise collection of practical and relevant data for anyone working on sound systems. The topics covered include microphones, gramophones, CDs to name a few. 190 pages. Hardback £10.95

NEWNES COMPUTER ENGINEER'S POCKET BOOK

This is an invaluable compendium of facts, figures, circuits and data and is indispensable to the designer, student, service engineer and all those interested in computer and microprocessor systems. 255 pages. Hardback £12.95

NEWNES ELECTRONICS POCKET BOOK 5th Edition

Presenting all aspects of electronics in a readable and largely non-mathematical form for both the enthusiast and the professional engineer. 315 pages. Hardback £12.95

NEWNES RADIO AND ELECTRONICS ENGINEER'S POCKET BOOK 18th Edition

Keith Brindley
Useful data covering math, abbreviations, codes, symbols, frequency bands/allocations, UK broadcasting stations, semi-conductors, components, etc. 325 pages. Hardback £10.95

POWER SELECTOR GUIDE BP235

J. C. J. Van de Ven
This guide has the information on all kinds of power devices in useful categories (other than the usual alpha numeric sort) such as voltage and power properties making selection of replacements easier. 160 pages. £4.95

FAULT FINDING

GETTING THE MOST FROM YOUR MULTIMETER BP239

R. A. Penfold
This book is primarily aimed at beginners. It covers both analogue and digital multi-meters and their respective limitations. All kinds of testing is explained too. No previous knowledge is required or assumed. 102 pages. £2.95

HOW TO USE OSCILLOSCOPES & OTHER TEST EQUIPMENT BP267

R.A. Penfold
Hints and ideas on how to use the test equipment you have, to check out, or fault find on electronic circuits. Many diagrams of typical waveforms and circuits, including descriptions of what waveform to expect with particular faults, or distortion in audio amplifiers. 104 pages. £3.50

MORE ADVANCED TEST EQUIPMENT CONSTRUCTION BP249

R.A. Penfold
A follow on from *Test Equipment Construction (BP248)* this book looks at digital methods of measuring resistance, voltage, current, capacitance and frequency. Also covered is testing semi-conductors, along with test gear for general radio related topics. 102 pages. £3.50

MORE ADVANCED USES OF THE MULTIMETER BP265

R.A. Penfold
This book is primarily intended as a follow-up to *BP239, Getting the most from your Multi-meter*. By using the techniques described in this book you can test and analyse the performance of a range of components with just a multi-meter (plus a very few inexpensive components in some cases). The simple add-ons described extend the capabilities of a multi-meter to make it even more useful. 96 pages. £2.95.

OSCILLOSCOPES, HOW TO USE THEM, HOW THEY WORK

3rd Edition
Ian Hickman
This book describes oscilloscopes ranging from basic to advanced models and the accessories to go with them. Oscilloscopes are essential tools for checking circuit

operation and diagnosing faults, and an enormous range of models is available. 248 pages. £15.95

TROUBLESHOOTING WITH YOUR TRIGGERED-SWEEP OSCILLOSCOPE

Robert L. Goodman
This book steers you through the various features - old and new - that scope technology provides and is an invaluable guide to getting the best out of your scope. An overview of available scopes will help you choose the one that best suits your needs. Areas covered include spectrum analysis, test applications, multiple-trace displays, waveform analysis, triggering, magnified sweep displays, analogue and digital scopes, etc. 309 pages. £17.50.

TELEVISION

ATV COMPENDIUM (THE)

Mike Wooding G6IOM
This book is for those interested in amateur television, particularly the home construction aspect. There isn't a 70cm section as the author felt this was covered in other books. Other fields such as 3cm TV, are covered in depth. A must for the practical ATV enthusiast. 104 pages. £3.00

GUIDE TO WORLD-WIDE TELEVISION TEST CARDS

Keith Hamer & Garry Smith
Completely revised and expanded, this is a very handy and useful reference book for the DXTV enthusiast. Over 200 photographs of Test Cards, logos, etc., world wide. 60 pages. £4.95

CONSTRUCTION

COIL DESIGN AND CONSTRUCTION MANUAL BP160

B.B. Bahani
Covering audio to r.f. frequencies, this book has designs for almost everything. Sections cover such topics as mains and audio output transformers, chokes and r.f. coils. What is the required turns ratio? This book will show you how to find out. Text and tables. 106 pages. £2.50

HOW TO DESIGN AND MAKE YOUR OWN PCBs BP121

R. A. Penfold
The purpose of this book is to familiarise the reader with both simple and more sophisticated methods of producing p.c.b.s. The emphasis of the book is very much on the practical aspects of p.c.b. design and construction. 66 pages. £2.50

MORE ADVANCED POWER SUPPLY PROJECTS BP132

R. A. Penfold
The practical and theoretical aspects of the circuits are covered in some detail. Topics include switched mode power supplies, precision regulators, dual tracking regulators and computer controlled power supplies, etc. 92 pages. £2.95

POWER SUPPLY PROJECTS BP76

R. A. Penfold
This book gives a number of power supply designs including simple unregulated types, fixed voltage regulated types and variable voltage stabilised designs. 89 pages. £2.50

RADIO/TECH MODIFICATIONS NUMBER 3

This book is intended as a reference guide for the experienced radio technician. Produced for the US market it contains modification instructions for a wide variety of scanners, CB rigs and amateur

equipment including Alinco, Icom, Kenwood, Yaesu and other makes. 160 pages. £9.95

SHORT WAVE SUPERHET RECEIVER CONSTRUCTION BP276

R.A. Penfold
A general purpose receiver to build, from antenna to audio, described in understandable English. 80 pages. £2.95

TEST EQUIPMENT CONSTRUCTION BP248

R.A. Penfold
Describes, in detail, how to construct some simple and inexpensive, but extremely useful, pieces of test equipment. Stripboard layouts are provided for all designs, together with wiring diagrams where appropriate, plus notes on their construction and use. 104 pages. £2.95

50 (FET) FIELD EFFECT TRANSISTOR PROJECTS BP39

F.G. Rayer
50 circuits for the s.w.l., radio amateur, experimenter or audio enthusiast using f.e.t.s. Projects include r.f. amplifiers and converters, test equipment and receiver aids, tuners, receivers, mixers and tone controls. 104 pages. £2.95

COMPUTING

INTRODUCTION TO COMPUTER COMMUNICATIONS (AN) BP177

R. A. Penfold
Details of various types of modem and their applications, plus how to interconnect computers, modems and the telephone system. Also networking systems and RTTY. 72 pages. £2.95

NEWNES AMATEUR RADIO COMPUTING HAND BOOK

Joe Pritchard GU1QW
Shows how radio amateurs and listeners can 'listen' to signals by reading text on a computer screen. This book also covers the application of computers to radio 'housekeeping' such as log-keeping, QSL cards, satellite predictions and antenna design as well as showing how to control a radio with a computer. 363 pages. £15.95

UPGRADE YOUR IBM COMPATIBLE AND SAVE A BUNDLE

Second Edition
Aubrey Pitgrim
Aimed at the owners of the IBM compatible computer, this book provides a very straightforward and easy to read guide on upgrading. The author has adopted a friendly and informative style and there are many excellent illustrations. Typically American in approach and style, the book provides much information and an excellent read. 245 pages. £16.95

MAPS

NORTH ATLANTIC ROUTE CHART

This is a five-colour chart designed for the use of ATC in monitoring transatlantic flights. Supplied folded. 740 x 520mm. £6.50

RADIO AMATEUR'S MAP OF NORTH AMERICA (USA)

Shows radio amateur prefix boundaries, continental boundaries and zone boundaries. 760 x 636mm. £3.50

RADIO AMATEUR'S PREFIX MAP OF THE WORLD (USA)

Showing prefixes and countries, plus listings by order of country and of prefix. 1014 x 711mm. £3.50

ORDER

LAST CHANCE!
 Subs prices held until August 12

SUBS CLUB

Be sure of your copy of *Practical Wireless* every month and qualify for the Subscribers' Club as well. Special offers and discounts are normally available to all members, including those abroad.



AR-270 144/430MHz Dual-Band Ringo Antenna

In keeping with our Antenna theme this month, we are offering Subscribers' Club Members the chance to buy an AR-270 144/430MHz Dual-Band Ringo Antenna for just £63.50 including postage and VAT.

The AR-270 is only 1.1m (3.75ft) high and is an ideal 144/430MHz base antenna. It offers good performance for its size and can be mounted anywhere from table-top to roof top.

Specifications

Electrical		
Frequency Bands	144-148MHz	430-450MHz
Bandwidth (2:1 v.s.w.r.)	>4MHz	>15MHz
Gain	3.7dB	5.5dB
Power Handling	250(f.m.)	250(f.m.)
Horizontal pattern v.s.w.r.	360°	360°
	1.2:1 Typical both bands	

Physical	
Height	1.13m (3.75ft)
Mast Size Limits	32-51mm diameter (1.25-2in)
Radial Length	171mm (6.75in)
Wind Loading	0.03(m ²) 0.27(ft ²)
Weight	900g (2lbs)

The normal retail price for this antenna is £72.50 including postage and VAT, but as a Subscribers' Club Member you can have one for just £63.50 including postage and VAT. Overseas subscribers please apply for postage rates on this offer.

Don't forget this is the last chance to subscribe at last year's rates, prices held until August 12.



ORDER FORM FOR ALL MAIL ORDER PURCHASES IN PRACTICAL WIRELESS

**CREDIT CARD ORDERS TAKEN ON (0202) 659930
 FAX ORDERS TAKEN ON (0202) 659950**

Or please fill in the details ticking the relevant boxes, a photo copy will be acceptable to save you cutting your beloved copy!

To: PW Publishing Ltd., FREEPOST, Arrowsmith Court, Station Approach, Broadstone, Dorset BH18 8PW.

SUBSCRIPTIONS

- PRACTICAL WIRELESS 6 MONTHS £10.50 (UK)
- PRACTICAL WIRELESS 1 YEAR £21.00 (UK)
- Please start my subscription with the.....issue.
 - \$45* (USA)
 - £23.00 (Europe)
 - £25.00 (Rest of World)

★★ PRICES HELD UNTIL 12 AUGUST 1993 ★★

SPECIAL JOINT SUBSCRIPTION WITH SHORTWAVE MAGAZINE 1 YEAR.
 £36.00 (UK) £39.00 (Europe) £41.00 (Rest of World) \$75* (USA)
 * \$ cheques only please.

SUBS CLUB OFFER

Please send meAR-270 antenna(s)
 @ £63.50! (UK) inc p&p £

My Subscriber Number is.....

BINDERS

Please send me.....PW Binder(s) @ £5.50each. £
 Postal charges. £1 for one, £2 for two or more. £

BOOKS

Please send me the following book/s,
 Postal charges. £1 for one, £2 for two or more.

..... £

..... £

..... £

..... £

..... £

..... £

Postal charges. £1 for one, £2 for two or more £

GRAND TOTAL £

PAYMENT DETAILS

Name

Address

.....Postcode

Telephone No.

I enclose cheque/PO (Payable to PW Publishing Ltd) £
\$
 Or
 Charge to my Access/Visa Card the amount of £
\$

Card No.

Valid fromto.....

SignatureTel:.....

Classified Ads

To advertise on this page see booking form below.

Service Sheets and Servicing

TECHNICAL INFORMATION SERVICES (PW)

76, CHURCH STREET, LARKHALL, LANARKSHIRE ML9 1HE
Phone: (0698) 884585, Mon-Fri, 9am-5pm. OR Phone: (0698) 883334 any other time.

IMMEDIATE despatch on all ACCESS & VISA orders
PHONE OR WRITE NOW FOR FREE QUOTE AND FREE CATALOGUE with every S.A.E.

SERVICE MANUALS AND SERVICE SHEETS

Remember, not only do we have EVERY Service Sheet ever made, but we also have

ONE OF THE WORLD'S LARGEST SELECTION OF SERVICE MANUALS

Note:- Over 200 separate titles of technical books are always in stock, over half are exclusive to TISI

CTV SERVICING by KING - £14.95, VCR SERVICING by BEECHINGS - £25.00, Ku-BAND SATELLITE TV - £25.00

SERVICE MANUALS

We can supply Service Manuals for almost any type of equipment. Televisions, Video Recorders, Amateur Radio, Test Equipment, Vintage Valve, any type of Audio Equipment, Military Surplus etc. etc.

All makes and models supplied from the 1930's to the present. Originals or photostats supplied as available.

FREE repair and Data Guide with all orders or SAE for your copy.

MAURITRON TECHNICAL SERVICES (PW)

8 CHERRY TREE ROAD, CHINNOR,
OXON, OX9 4QY
Tel: (0844) 51694 Fax: (0844) 52554



DISCLAIMER

Some of the products offered for sale in advertisements in this magazine may have been obtained from abroad or from unauthorised sources. *Practical Wireless* advises readers contemplating mail order to enquire whether the products are suitable for use in the UK and have full after-sales back-up available.

The publishers of *Practical Wireless* wish to point out that it is the responsibility of readers to ascertain the legality or otherwise of items offered for sale by advertisers in this magazine.

Service Sheets

TECHNICAL MANUALS, AR88, CR100, R210, HRO, £5 each. Circuits only. 150 pence, plus S.A.E., lists thousands. Bentley, 27 De Vere Gardens, Ilford Essex IG1 3EB. Phone: 081 554 6631

Holidays

FLORIDA Gulf Coast. Two luxury villas. Private beach, pools, water frontage, golf course. Sleeps six, £350 p.w. G1GTO. Tel: 0502 732382.

Miscellaneous

DIY Inexpensive radio projects. Easy to make, SAE, RYLANDS, 39 Parkside Avenue, Southampton SO1 9AF.

CONVERT YOUR P.C.B. ARTWORK to reality from only £20 Tel 0384 572175

Computer Software & Hardware

ULTIMATE MORSE TUTOR for PC's and ATARI! £30.00. Interface cable supplied. Free demo, PLEASE state computer type and disk size.
BOSCAD Ltd, 16 Aytoun Grove, Baldridgeburn, Dunfermline, FIFE KY12 9TA. Tel: 0383 729584, evenings.

SHACKLOG V3 The PC logging system. Real time QSO logging, DXCC needs alert, QSL labels, rig control, database analysis, reports etc. Simultaneous packet operation. Optional on-line IOTA database (G3KMA). Plus lots more! £27.50 inc comprehensive manual. SASE for full details to G3PMR, 30 West Street, Great Gransden, Sandy, SG19 3AU. Tel: (0767) 677913.

ORSCW Morse Practice Software for the IBM PC aimed specifically at the new Morse test. Generates random 'QSO format' texts and has all the other features expected from a good Morse tutor. Send 10 pounds (Payable to M.D. Waller) to Chellows, Edwarton, Ipswich, IP91LJ. State media required.

ACORN ARCHIMEDES Morse tutor, filter design, frequency prediction, antenna designer - all for £9.95. G3TXQ, 21 Green Street, Milton Malsor, Northampton, NN7 3AT.

PC TECHNICAL SHAREWARE

Would you like to see the best range of low cost technical and scientific public domain and shareware for IBM PC in the UK?

HUGE RANGE includes:- PACKET, FAX, RX/TX control, PCB design, Circuit and ANTENNA analysis, QSO logging, CAD ELECTRONIC AND MECH engineering, SCIENTIFIC, MATHS AND STATS, MEDICAL, PROGRAMMING, SOURCE CODE, DATA, EDUCATION, WINDOWS, BUSINESS and lots more.

Write phone or fax today for your free 124 page printed catalogue.

The Public Domain Software Library
Winscombe House, Beacon Road
Crowborough, Sussex TN6 1UL
Tel 0892 663298, Fax 0892 667473

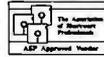

PC SHAREWARE
only £2.50
per disk

Many titles including superb Morse Tutor (send/receive), Wave Propagation Predictor, full featured Log Book etc.

For immediate despatch of details phone

ARC SOFTWARE LTD
(0489) 782110 24 hours

ORDER FORM FOR CLASSIFIED ADS PLEASE WRITE IN BLOCK CAPITALS

The prepaid rate for classified advertisements is 42 pence per word (minimum 12 words), box number 70p extra. Semi-display setting £13.90 per single column centimetre (minimum 2.5cm). Please add 17.5% VAT to the total. All cheques, postal orders, etc., to be made payable to the PW Publishing. Treasury notes should always be sent by registered post. Advertisements, together with remittance should be sent to the Classified Advertisement Dept., Practical Wireless, Arrowsmith Court, Station Approach, Broadstone, Dorset BH18 8PW. Tel: (0202) 659920, Fax: (0202) 659950

Please insert this advertisement in the issue of Practical Wireless (if you do not specify an issue we will insert it in the next available issue of PW) for insertion/s., I enclose Cheque/P.O. for £..... (42p per word, 12 minimum, please add 17.5% VAT to total),

Name:

Address:

Telephone No.:

Box Number @ 70p: Tick if appropriate

Category heading:

Educational

COURSE FOR CITY AND GUILDS Radio Amateurs Examination. Pass this important examination and obtain your licence, with an RRC Home Study Course. For details of this and other courses (GCSE, career and professional examinations, etc) write or phone - THE RAPID RESULTS COLLEGE, DEPT JX110, Tuition House, London SW19 4DS. Tel: 081-947 7272 (9am-5pm) or use our 24hr Recordacall service 081-946 1102 quoting JX112

HEATHKIT EDUCATIONAL PRODUCTS/UK DISTRIBUTOR Spares and Service Centre. Cedar Electronics, 12 Isbourne Way, Broadway Road, Winchcombe, Cheltenham. Glos. GL54 5NS. Tel: (0242) 602402.

Receivers

TRANSCIVER P.R.C. 316 HF AM CW 4 Watts. Output with speaker/mic and manual £135.00 Megger, crank handle type 500v £45.00. AVO minor multimeter £25.00 HF Wattmeter CT211 25 watt 70Ω and 1 watt 50Ω £12.00 Last few. All prices include P+P. Send SAE for list C.P. Surplus 56a Worcester Street, Wolverhampton WV2 4LL.

B.F.O. KITS Resolves single side-band on almost any radio, £16.49. H. CORRIGAN, 7 York Street, Ayr KA8 8AR.

Transceivers

BUDGET 2m FM rigs with conversion data: PYE Cambridge FM10B boot unit only: £7 PYE WESTMINSTER LW15FM boot unit only: £15. UK mainland carriage £8 any quantity. VAT inclusive. Callers welcome (phone first). GAREX ELECTRONICS, STATION YARD, SOUTH BRENT TQ10 9AL. Tel. 0364 72770

Wanted

WANTED FOR CASH Valve communication receivers and domestic valve radios (working or not). Items of Government surplus wireless equipment and obsolete test equipment. Pre-1965 wireless and audio components and accessories. Pre-1975 wireless and TV books and magazines. Also, most valves wanted for cash. Must be unused and boxed. CBS, 157 Dickson Road, Blackpool, FY1 2EU. Tel: (0253) 751858 or (0253) 302979.

Components

HIGH POWER VARIABLE CAPACITORS for 25kW transmitter (Five) Three unused. Best offers Secure. 0604 715944

IS YOUR CLUB PLANNING OR HOLDING AN EVENT OR RALLY?



(0202)

659920

to find out the
SPECIAL ADVERTISING RATES
available for
RADIO CLUBS

ADVERTISERS

To advertise in the **SEPTEMBER** issue please send copy by
21st JULY

CLASSIFIED ADS

This page is seen by thousands,
be sure they see you.

 **Ailsa** on 0202 **659920**

Recruitment

ENTHUSIASTIC AND SELF MOTIVATED PROFESSIONALS ARE INVITED TO APPLY TO JOIN A SUCCESSFUL AND EXPANDING COMPANY, SPECIALISING IN AMATEUR RADIO

SALES EXECUTIVE

- ★ Must be a licensed & active Radio Amateur
- ★ Possess good customer contact skills
- ★ Be enthusiastic in prospecting for new customers
- ★ Be of smart appearance, with a cheerful & pleasant manner
- ★ Possess masses of energy & prepared to work anti-social hours to please our ever expanding customer base.

CUSTOMER LIAISON ADMINISTRATOR

- ★ Preferably be a licensed Radio Amateur
- ★ Possess strong communication skills, dealing with customer repair queries and after sales follow-ups
- ★ Able to use computers for data entry (training may be given)
- ★ Be of pleasant disposition, not easily flustered & able to work unsupervised.

If you feel you have the skills and determination to work for the busiest and most professional organisation in Amateur Radio, then drop me a line.

Martin Lynch G4HKS.

286 Northfield Avenue, Ealing, London W5 4UB.
Tel: 081 566 1120 FAX: 081 566 1207.

MARTIN LYNCH
G4HKS
THE AMATEUR RADIO EXCHANGE CENTRE

FACT. NOT FICTION.

The ABC allows professional buyers and sellers of advertising space in national and regional newspapers and consumer magazines to buy and sell better. It does so by providing an independent, authoritative circulation audit that is the single most obvious indicator of a magazine's self esteem and a publisher's confidence in his title.

ABC
AUDIT BUREAU OF CIRCULATION

An ABC certificate is your guarantee of integrity. So, if your next schedule includes titles that aren't audited - ask why. For details of ABC's activities relating to the consumer press and the benefits of ABC membership contact Anthony Peacham, Consumer Press Manager, on 0442 870800.

Audit Bureau of Circulations Ltd., Black Prince Yard, 207-209 High Street, Berkhamstead, Herts., HP41AD. Tel: 0442 870800 Fax: 0442 877408

YOUR LOCAL DEALERS

SOUTH WALES

ELECTRO MART

Receivers, Scanners, Howes, ERA, CB, Marine radio etc. part exchange welcome.

Full Service & Repair Facilities

96 High St, Clydach,
Swansea
Tel: 0792 842135

SOUTHAMPTON

South Midlands Communications

Official Yaesu Importer

S.M. House, School Close,
Chandlers Ford Industrial Estate,
Eastleigh, Hants SO5 3BY.
Tel: 0703 255111

PORTSMOUTH

Nevada Communications

Visit our showrooms for Icom, Kenwood, amateur radio products and a large range of scanning receivers. New and part exchange welcome.

189 London Road,
North End, Portsmouth,
Hants, PO2 9AE
Tel: 0705 662145

DERBYSHIRE

RILEY'S T.V. SERVICES LTD.

SUPPLIERS OF:-
SCANNERS - C.B. 27-934 MHz -
AERIALS - TEST METERS - TOOLS -
TELEPHONES KITS AND CABLES

125 LANGWITH ROAD
HILLSTOWN
CHESTERFIELD S44 6LX
PHONE 0246 826578
CLOSED WEDNESDAY

HERNE BAY



ICOM (UK) LIMITED

The Official Icom Importer

Unit 8, Sea Street
Herne Bay, Kent CT6 8LD
Tel: 0227 741741
Fax: 0227 741742

Open Tuesday-Friday 9-17.30, Saturday 9-17.00

SCOTLAND

JAYCEE ELECTRONICS LTD

20 Woodside Way, Glenrothes, Fife KY7 5DF
Tel: 0592 756962 (Day or Night)
Fax No. (0592) 610451
Open: Tues-Fri 9-5; Sat 9-4

KENWOOD, YAESU & ICOM APPROVED DEALERS
A good stock of new and secondhand equipment always in stock

IRELAND

RADCOM ELECTRONICS

All your requirements under one roof

RECEIVERS - TRANSCEIVERS - ACCESSORIES

Open Monday-Saturday 9am-5.30pm

Midleton Enterprise Park, Midleton,
County Cork 021/632725 + 613241

DEVON

Reg. Ward & Co. Ltd.

The South-West's largest amateur radio stockist. Approved dealer for Kenwood, Yaesu and Icom

1 Western Parade,
West Street, Axminster,
Devon, EX13 5NY
Tel: 0297 34918

(Closed 1.00-2.00 and all day Monday)

BUCKINGHAMSHIRE

Photo-Acoustics Ltd.

Approved Kenwood, Yaesu and Icom dealer (part exchange always welcome)

58 High Street, Newport Pagnell,
Buckinghamshire MK16 8AQ
Tel: 0908 610625

(Mon-Fri 9.30-5.30, Sat 9.30-4.30)

TYNE + WEAR

SUPERTECH Communications Specialists

YUPITERU SONY.



Official Nevada and Kernow stockists

Full range of CBs,
Scanners + Accessories

Mail Order -

Branches throughout the North East

32 RUSSELL WAY

GATESHEAD METRO CENTRE NE11 9YZ

TEL: (091) 4932316

Open: Monday-Friday 10am - 8pm

Thursday 10am - 9pm

Saturday 9am - 7pm

Contact Lynn
on the
Advertising
Hotline

(0202) 659920

YORKSHIRE

YAESU



Kenwood

Alan Hooker Radio Communications

42, Netherhall Road, Doncaster

Tel: 0302 325690

Open Mon-Sat 10-5pm

Closed Thursdays

CORNWALL

24hr, 7 days a week

SKYWAVE

RADIO AMATEUR AND MARINE
COMMUNICATIONS SERVICES

ICOM, YAESU, NAVIGO,
JAYBEAM, etc.

Slades Road, St. Austell,
Cornwall PL25 4HG

Tel: 0726 70220

Voice Bank: 0426 961909

KENT



KANGA PRODUCTS

For QRP kits

A variety of kits for RECEIVERS,
TRANSMITTERS & TEST GEAR.

Send an A5 SAE for a free copy
of our catalogue

Seaview House, Crete Road East, Folkestone, CT18 7EG
Tel/Fax 0303 891106 0900 - 1900 Only

WEST SUSSEX

MAIL ORDER
RETAIL



BREDHURST ELECTRONICS LTD.

High St., Handcross, West Sussex

Tel: (0444) 400786

Fax: (0444) 400604

Situated at the Southern end of M23.

Easy access to M25 and
South London.

Open Mon-Fri 9am-5pm

Sat 9.30am-4.30pm.



YAESU

ICOM

ADVERTISERS INDEX

A. A. & A	37	G3RCQ	31	R.F. Engineering	31
A. H. Supplies.....	58	Haydon Communications	51	RAS Nottingham	52
Aerial Techniques	42	Hesing Technology	52	Reg Ward	37
Alan Hooker.....	8	Howes, C.M.....	42	RSGB	52
Altron Communications.....	51	Icom	Cover iii,2	S.R.P. Trading.....	24
AOR.....	29	Kenwood	3	Shortwave Centre	47
Besprint.....	42	Key Solar Systems	47	South Essex Comms	31
Birkett, J.....	47	Lake Electronics	42	South Midlands Comms	Cover ii
Bredhurst Electronics	58	Langrex Supplies.....	29	Specialist Antenna Systems	29
Castle Electronics	31	Lowe Electronics	6,7	Spectrum Communications	51
Cirkit.....	24	Maplin Electronics	Cover iv	Suredata.....	47
Colomor	31	Martyn Lynch	14,15,67	Waters & Stanton	4,5
Datong	37	Nevada	18,19	Welland Communications	58
Dewsbury Electronics	47	Peter Rodmell	58		
Eastern Communications	52	Quantek Electronics.....	47		

HANDHELD HEAVEN

IC-P2E/P2ET

The picture below shows the IC-P2E 144MHz FM transceiver, typical of ICOM's new wave of handhelds. The IC-P2ET has extended functions and is keypad operated. Both of these compact radios have AI (Artificial Intelligence) a unique feature that allows instant access to



previous functions. The IC-P2E and P2ET will evaluate your operating capability and memorize the order of functions used. Other features include: 100 memory channels, programmable call channel, ergonomic design, system clock with timer and lots more.

IC-P4E/P4ET

The IC-P4E and P4ET (pictured) are 430MHz FM transceivers, visually similar to the IC-P2E range. Features include: compact and ergonomic design, 100 memory channels, 5 watt power output with 13.8VDC cartridge type battery pack, full programmed and memory scan



features, a variety of tuning steps, simple 1750Hz tone call, auto power-save and frequency lock function. The durable splash-resistant body measures 49W x 105H x 38D mm. and weighs a mere 280g. We think you will agree that these compact handhelds will prove to be winners.

IC-2iE/4iE

These two new, ultra-slim and rugged handhelds have got to be the smallest transceivers around. Even including battery pack, these radios will fit snugly into your shirt/jeans pocket or handbag. The IC-2iE operates on 144-146MHz FM and the IC-4iE on 430-440MHz UHF FM bands. Both of these



radios feature maximum 5 watt output (with 13.8VDC battery), output miser to conserve battery power, 10 memory channels, scanning, power-save function and dual tuning steps. A full range of practical accessories are also available to make these pocket pals even more fun to operate.

IC-W2iE

The IC-W2iE offers dual-band 144/430MHz simple operation using few switches and independent volume / squelch for each band.

The ergonomic and splash-resistant design makes the IC-W2iE a snug fit in the palm of your hand. Features include: cellphone-style



'whisper' function. This allows cross band full duplex use via the mic-equipped battery pack, and easier operation with repeater memory. Every time you depress a repeater call setting, it automatically memorizes a repeater memory.

IC-W2iET

The W2iET has the same dual-band performance characteristics as the IC-W2iE but sports a command keypad and relocated back-lit display (manual operation is also available). Features are as the IC-W2iE and include: battery capacity indicator, remote control via an optional HM-75



speaker mic, 70 channels, dial-select steps, monitor function, high-speed scan functions, frequency lock function, external DC power jack for mobile use, auto power-down to allow last minute operation before battery fades, giving you the most from your IC-W2iET.

IC-2SRE/4SRE

The distinctive appearance of these two handhelds is bound to start the tongues wagging. You can enjoy the advantages of a handheld transceiver



with a wideband receiver allowing true reception of FM Broadcast, All and Marine bands. Until now this was only achieved by purchasing separate equipment. The IC-2SRE is a 2m FM transceiver with wideband receive and the IC-4SRE is its 70cm companion. Other great features include: selective calling, 30 ham memory and 60 wide band receive memory channels plus loads more.

N.B. Photographs not to scale

ICOM manufacture a full range of base-stations, transceivers and receivers capable of operating on all amateur bands and beyond.

No matter what your requirement ICOM have the radio for you.

For more information and the location of your local Icom dealer contact:

Icom (UK) Ltd. Sea Street Herne Bay Kent CT6 8LD
Telephone: 0227 741741 (24hr). Fax: 0227 741742

ICOM

NEW

FULL COLOUR GUIDE TO ELECTRONIC PRODUCTS

Maplin



BS 5750
Part 2 1987

Level B:
Quality Assurance
RS12750



Order your copy of the New MAPLIN Catalogue on sale 3rd September!
Pick up a copy from any branch of WHSMITH or from our chain of stores for just £2.95 or
post this coupon now to receive your copy for just £3.45 inc. p&p. If you live outside the
U.K. send £6.80 or 18 IRCs for Airmail in Europe/£5.20 or 13 IRCs for surface
mail outside Europe, or £11.50 or 30 IRCs for Airmail outside Europe.
I enclose £3.45/£6.80/£5.20/£11.50 (delete as applicable).

Name.....
Address.....
Post Code.....
Send to Maplin Electronics,
P.O. Box 3, Royleigh,
Essex, England
SS6 8LR
PWP

Over 700 colour packed pages with hundreds
of brand New Products at Super Low Prices,
on sale from **3rd September, only £2.95.**

Available from all branches of **WHSMITH** and Maplin
stores nationwide. The Maplin Electronics 1994
Catalogue – **UNIQUELY DIFFERENT!**

