

This Christmas

if your imagination stops at cigars...

...give Antex



MODEL X25 Soldering Iron
220-240 Volts or 100-120 Volts. The leakage current of the NEW X25 is only a few microamps and cannot harm the most delicate equipment even when soldered "live". Tested at 1500v. A.C. This 25 watt iron with its truly remarkable heat-capacity will easily "out-solder" any conventionally-made 40 and 60 watt soldering irons, due to its unique construction advantages. Fitted long life iron-coated bit 1/8". 2 other bits available 3/32" and 3/16". Totally enclosed element ceramic and steel shaft. Bits do not "freeze" and can easily be removed. **PRICE £1-93** (rec. retail) P & P 8p. Suitable for production work and as a general purpose iron.



MODEL CCN
220 volts or 240 volts. The 15 watt miniature model CCN also has negligible leakage. Test voltage 4000v. A.C. Totally enclosed element in ceramic shaft. Fitted long life iron-coated bit 3/32". 4 other bits available 1/8", 3/16", 1/4" and 3/64". **PRICE £2-15** (rec. retail) P & P 5p.

MODEL G 18 watt miniature iron, fitted with long-life iron-coated bit 3/32". Voltage 240, 220 or 110. **PRICE £2-15**. (rec. retail) P & P 5p.



MODEL CN Miniature 15 watt soldering iron fitted 3/32" iron-coated bit. Many other bits available from 3/64", to 3/16". Voltages 240, 220, 110, 50 or 24. **PRICE £1-93**. (rec. retail) P & P 5p.



all prices include VAT at 10%



MODEL SK.2 KIT
Contains 15 watt miniature iron fitted with 3/16" bit, 2 spare bits 5/32" and 3/32" heat sink, solder, stand and "How to Solder" booklet. **PRICE: £2-87**. (rec. retail) P & P 8p.

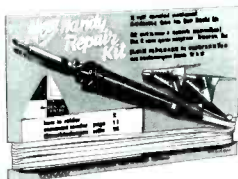

MODEL MLX KIT
Battery operated 12v. 25 watt iron fitted with 15" lead and 2 heavy clips for connection to car battery. Packed in strong plastic wallet with booklet "How to Solder". **PRICE £2-27** (rec. retail) P & P 12p.

MODEL SK.1 KIT
Contains 15 watt miniature iron fitted with 3/16" bit, 2 spare bits 5/32" and 3/32", heat sink, solder, stand and "How to Solder" booklet. **PRICE £3-25** (rec. retail) P & P 12p.



From radio or electrical dealers, car accessory shops or in case of difficulty direct from:—
ANTEX LTD. FREEPOST
(no stamp required) **PLYMOUTH**
PL1 1BR Tel: 0752 67377.

Please send the following:

I enclose cheque/P.O./Cash (Giro No. 2581000)

NAME

ADDRESS

PW/12

PRACTICAL WIRELESS

VOL. 49 NO. 8
ISSUE 802
DECEMBER 1973

BRITAIN'S PREMIER MAGAZINE FOR THE DO-IT-YOURSELF RADIO AND ELECTRONICS CONSTRUCTOR

EDITOR Morris A. Colwell

ASSISTANT EDITOR
Lionel E. Howes, G3AYA

ART EDITOR Peter Metalli

TECHNICAL EDITOR
Eric Dowdeswell, G4AR

**PRODUCTION & NEWS
EDITOR** Colin R. Riches

PROJECTS SUB-EDITOR
Geoffrey C. Arnold

TECHNICAL ARTIST
Alan Martin

SECRETARIAL
Jenny Maunder
01-634 4292 Susan Corne

ADVERTS. MANAGER
01-634 4293 Roy Smith

CLASSIFIED ADVERTS.
01-634 4301 Colin R. Brown

Published by IPC Magazines Ltd.,
Fleetway House, Farringdon Street,
London EC4A 4AD. Tel. 01-634 4444

SUBSCRIPTIONS

Publisher's Subscription Rates for one year to any part of the world £2.65 including postage. Enquiries to Subscription Department, IPC Magazines Ltd., Carlton House, 68 Gt. Queen Street, London, WC2 5DD. Phone 01-242 4477. International Giro facilities Account No. 5122007. Please state reason for payment "message to payee".

Binders (£1.10) and indexes (11p) can be supplied by the Binders Dept at the same address.

BACK NUMBERS

We regret that we are unable to supply back numbers of Practical Wireless. Readers are recommended to enquire at a public library to see copies. Requests for specific back numbers of Practical Wireless and Television only can be published in our CQ Column.

COPYRIGHT AND QUERIES

© IPC Magazines Limited 1973. Copyright in all drawings, photographs and articles published in "Practical Wireless" is fully protected and reproduction or imitation in whole or in part is expressly forbidden. All reasonable precautions are taken by "Practical Wireless" to ensure that the advice and data given to readers are reliable. We cannot, however, guarantee it and we cannot accept legal responsibility for it. Prices are those current as we go to press.

We regret that we cannot answer technical queries by telephone nor can we provide information or advice on manufacturers' products other than that given in the magazine. We will endeavour to assist readers who have queries relating to articles published but we cannot offer advice on modifications to our published designs. All correspondents expecting a reply should enclose a stamped addressed envelope.

● NEWS & COMMENT

- 726 "STEAM" ROLLING—Leader article and January preview
- 727 NEWS . . . NEWS . . . NEWS . . .
- 734 TELEVISION—Coming in the December issue
- 750 HOTLINES on recent developments by Ginsberg
- 751 NEXT MONTH in Practical Wireless
- 742, 762 DEAR SIR—Readers' letters to the Editor
- 771 ON THE AIR—Reports on Broadcast Bands
- 771 Short Wave—Malcolm Connah
- 772 Medium Wave—Charles Molloy
- 772 VHF/FM—Simon David
- 775 Amateur Bands, Short Wave/VHF—David Gibson, G3JDG

● CONSTRUCTIONAL

- 728 3-BAND SHORT WAVE RECEIVER—F. G. Rayer, G3OGR
- 737 USING THE LM380N AMPLIFIER—J. B. Dance, M.Sc.
- 746 EXPERIMENTAL WORKSHOP Trigger Circuits—M.J. Hughes, M.A.
- 752 PORTABLE FLUORESCENT LAMP UNIT—from your 12V battery
- 763 GOING QUADRAPHONIC—PROJECT Q4, Part 3—D. Bollen
- 770 TAKE 20 No. 55 Triplex Signalling Unit—David Andrews

● OTHER FEATURES

- 734 TECHNICROSS No. 1—Solution
- 745 GOING BACK Equipment of yesteryear—
Colin Riches and Arthur Dow
- 757 SUCCESSFUL SOLDERING—V. Capel

● EXTRA WITH THIS ISSUE

INSET P.W. DATACARDS in COLOUR

- No. 5 Resistance and Capacitance Calculator
- No. 6 D.C. Circuits

RSC GROUP/DISCO UNITS

50 WATT SPEAKER **100 WATT AMPLIFIER** **50 WATT SPEAKER**

HEADPHONES MICROPHONE

TWIN TURNTABLE WITH PRE-AMP

RSC DISCO MASTER

DISCOTHEQUE CONSOLE with integrated power supply, 100W OUTPUT TWIN JACK OUTPUT SOCKETS Inc. twin Garrard SP25 Mk.III or BSR Macdonald MP60 type turntables. Pick-ups with high compliance cartridges and diamond styl. Separate volume controls for each turntable.

FULL MONITORING FACILITIES plus Treble and Bass controls. Separate input for mic. with vol. control switch. Rexine covered cabinet size approx. 32" x 18" x 7" with lid **ONLY £99.75**

Terms: Deposit £20 and 12 monthly payments £7.80 (Total £111.20). Carr. £2.50.

R.S.C. COLUMN SPEAKERS

IDEAL FOR VOCALISTS AND PUBLIC ADDRESS

All types 15 Ohms covered in Rexine and Vynair

TYPE C4100 IS ALSO SUITABLE FOR BASS GUITAR OR ELECTRONIC ORGAN

TYPE C132 30-40 WATTS Fitted two exceptionally efficient, low feedback horn characteristic high flux 13" x 8" 20 watt **£21.95** speakers. Terms: Dep. £2.95 and 9 monthly payments £2.43 (Total £24.82) Carr. 65p.

TYPE C4100 100 WATTS inc. four 12" 50 watt speakers for conservative rating. Extra heavy construction. Size approx. 88x16x10" Acoustically filled and pressurised. Terms: Dep. £15.50 & 12 mthly. pmts. £5.46 (Total £81.02). Carr. £1.50

F.A.L. DISCO PRE-AMPLIFIER

£18.97

Designed for use with a pair of Player Units and Amplifier with Bass and Treble Controls. Incorporates MONITORING FACILITIES and Mic. input. The 4 inputs are ind. controlled. Selector switch Gram (1), (2), and Tape. 200-250V A.C. Mains 50Hz. Brush Silver finished fascia. Size approx 16 1/2" x 3" x 4" deep. Fully enclosed but can mounted in cabinet.

FANE "CRESCENDO" SPEAKERS

FULL RANGE AVAILABLE AT ALL BRANCHES

FAL PHASE 50 Mk.III AMPLIFIER 50 WATT.

Solid state. 4 Separately controlled inputs Plus master vol. control. Ind. Bass and Treble Controls. Protective circuit to guard against damage from accidental shorts. Output for Speaker's 3 to 30 ohms. Size 17" x 7" x 7 1/2". 200-250V. A.C. mains. Output 60 watts music rating.

Or deposit £8.83 & 9 monthly payments £4.22. Total £44.91. **£39.93** Carr. 85p.



RSC PHANTOM '50'

Combined 50W Amplifier and 12in. Loudspeaker.

For Lead Guitar, Mic., Gram, Radio, Tape (Not for use with Bass instruments). Inc. 3 inputs and 2 vol. controls plus Treble, Bass and Presence. Output Jack for additional 15 ohm Speaker. Attractively finished in black with silver-finished fascia and trimmings. Compact size. Fitted carrying handle.

Terms: Deposit £8.95 and 12 monthly payments £4.97 (Total £88.50). Carr. Free S.A.E. for leaflet. **ONLY £59.95** U.K. Mainland

RSC BASS-REGENT 50 WATT AMPLIFIER

A powerful high quality all-purpose unit for lead, rhythm, bass guitar, vocalists, gram, radio, tape. Peak Output rating. Loudspeaker unit either horizontal or vertical mounting.

* Two extra heavy duty 12in. 50w Loudspeakers.

* Four Jack inputs and two Volume Controls for instant use of up to four pick-ups or "mikes". Bass and Treble controls. Send S.A.E. for leaflet.

Credit Terms: Deposit £15.50 & 12 monthly payments of £5.56. (Total £82.12). Carr. £2.50 **£72.50**

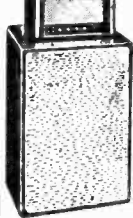

RSC GP30 HI-FI AMPLIFIER

For Guitar, Vocal or Instrumental Group

A 4 input, 2 vol. control Hi-Fi 30 watt unit with separate Bass and Treble controls. Current values. Peak output rating. Strong Rexine cover-cabinet with handles. Attractive black/silver P.V.C. fascia. Neon indicator.

For 200-250V. A.C. mains. For 3 or 15 ohm speakers. Send S.A.E. for leaflet. Terms: Deposit £4.40 and 9 monthly payments of £2.78 (Total £29.13). **£25.85** Carr. 75p

NOW SIX NEW BRANCHES

BOLTON 23 DEANS GATE
COVENTRY 17 SHELTON SQUARE
DONCASTER 3 QUEENSGATE
WATERDALE CENTRE
NOTTINGHAM 19/19A MARKET ST
STOCKPORT 8 LITTLE UNDERBANK
SUNDERLAND 5 MARKET SQUARE
NEW LARGER PREMISES AT **HULL, DARLINGTON, NEWCASTLE & DERBY** See Addresses

RSC

HI-FI CENTRES LTD.

MAIL ORDERS & EXPORT ENQUIRIES TO:
AUDIO HOUSE, HENNINGER LANE, LEEDS, 13.
Tel: Padesley 0973577691.
TERMS C.W.O. or C.O.D. NO C.O.D. under £1.
POSTAGE 28p EXTRA UNDER £2. 33p EXTRA OVER £2 OR AS QUOTED. TRADE SUPPLIED.
S.A.E. PLEASE WITH ENQUIRIES.
SUPPLIERS TO GOVT. DEPTS. H.M. FORCES. EDUCATION AUTHORITIES & HOSPITALS, ETC.
MAIL ORDERS MUST NOT BE SENT TO SHOPS

PACKAGE OFFER

Units listed below

(a) 100w POWER AMPLIFIER
(b) PAIR OF HI-FI HEADPHONES
(c) MATCHING DYNAMIC 'MIKE' (attached to h'phone)
(d) PAIR 50 WATT SPEAKERS Black Rexine covered Cabinets Size approx. 15" x 18" x 8"
(e) RSC TDI DISCO CONSOLE

(a) (b) (c) (d) & (e) **£149.95**

Carr. £3.00

Terms Deposit £30 and 18 monthly payments of £8.33 (Total £179.94).

RSC TDI DISCO CONSOLE

Incorporating twin Garrard SP25 or BSR MP60 type turntables and Sonotone or Acos Cartridges with diamond stylus. Separate Vol. controls for each turntable. Also MONITORING FACILITIES, plus Treble and Bass Controls. Separate input for 'mike' with vol. control switch. Black Vynide covered Cabinet with lid. See illustration on left

Or Dep. £9.95 and 12 mthly pmts £5.85 (Total £80.15) **£69.95**

Carr. £1.50

FANE ULTRA HIGH POWER LOUDSPEAKERS

All power ratings are E.M.S. continuous, 2 YEARS' GUARANTEE High flux ceramic magnets, ALL CARRIAGE FREE.

'POP' 100	'POP' 60	'POP' 50
18" 100 Watt 14,000 gauss 8/15"	15" 60 Watt 13,000 gauss 8/15"	12" 50 Watt 12,000 gauss 5/11"
£25.95	£14.75	£11.99
Dep. £5.95 and 9 mthly payments £2.58 (Total £28.99)	Dep. £3.75 and 9 mthly payments £1.50 (Total £17.25)	Dep. £2.99 and 9 monthly payments £1.28 (Total £14.51)

FOR BASS GUITAR, ELECT. ORGAN, ETC.

FANE SPEAKERS 'POP'

25/2 12 in. 25 WATT Dual Cone 15 Ω (for use other than Bass Guitar or Electronic Organ). Carr. free **£7.95** or Dep. £1.25 and 9 mthly payments 89p (Total £9.20).

DISCO PACKAGE OFFER

£45

Pair BSR MP60 T/tables GP91 PU Cartridges. FAL Disco Pre-amp. Total Rec. Ret. Price £50.11 Carr. £1

GROUP/DISCO EQUIPMENT PACKAGE OFFERS

P.A.L. PHASE 50 MK.III AMPLIFIER PR. FANE POP 25/2 25W SPEAKERS Terms: Deposit £7.50 and 12 monthly payments of £4.29 (Total £58.98)	£89.83 £15.90 £55.83	PACKAGE PRICE £51.50 Carr. £1.10
P.A.L. PHASE 60 MK.III AMPLIFIER PR. FANE POP 60 L/SPEAKERS Terms: Deposit £9.50 and 12 monthly payments of £4.88 (Total £68.06)	£89.83 £23.98 £65.81	PACKAGE PRICE £59.50 Carr. £1.10
P.A.L. PHASE 50 MK.III AMPLIFIER PAIR L12/20 25W L/S in cabinets Terms: Deposit £10 and 12 monthly payments of £5.17 (Total £72.04)	£89.83 £26.30 £63.53	PACKAGE PRICE £63 Carr. £1.35
P.A.L. PHASE 100/2 AMPLIFIER 4 FANE POP 60 L/SPEAKERS Terms: Deposit £20 and 18 monthly payments of £8.35 (Total £134.30)	£89.85 £47.96 £117.81	PACKAGE PRICE £110 Carr. £2

HIGH QUALITY LOUDSPEAKER UNITS

ALL TWO TONE REXINE AND VYNAIR FINISH

L125 50 WATT Fitted pair of 12" 50 watt high flux speakers for conservative rating. Impedance 8-15 ohms. Carr. £1.50

Or deposit £3.95 and 9 monthly pmts. of £4.34. Total £43.01

L12/20 12" 20-25 WATT 13,000 ohm. Size approx 14" x 9". Carr. 80p. Dep. £1.25 & 9 mthly pmts £1.06 (Total £10.79) **£37.95** **£8.25**

CREDIT TERMS AVAILABLE ON PURCHASES OVER £10 (Kits Excepted) INTEREST CHARGES REFUNDED ON CREDIT SALES Settled in 3 months

FAL PHASE 100/2 AMPLIFIER

100 WATTS MUSIC RATING. Solid State. Sep. Bass and Treble Controls. 4 separately-controlled inputs plus master control. Output for speakers 3-30 ohms. Includes protective circuit against damage from short circuits.

Terms: Deposit £7.85 & 12 monthly payments £6.05 (Total £80.45). **£69.85** Carr. 82p



FAL TWIN CHANNEL AMPLIFIERS

Solid State. 4 sep. controlled inputs plus master volume control. Individual Bass and Treble controls. Output for speakers 3-30 ohms. Protective circuitry against damage from short circuits.

FAL 'SUPER 50' 50 WATTS MUSIC RATING **£59.50** Carr. 80p

Terms: Dep. £8.50 & 12 mthly. pmts. £1.97 (Total £88.14)

FAL 'SUPER 100' 100 WATTS MUSIC RATING **£79.95** Carr. 90p

Terms: Dep. £11.95 & 12 mthly. pmts. £6.63 (Total £91.51). Prices above include protective dust cover.

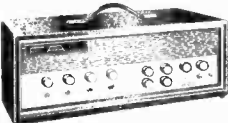

HUGE DISCOUNTS ON LEADING BRAND TAPE AND TURNTABLE UNITS

CREDIT TERMS AVAILABLE
Minimum Deposit 10%

DISCOUNT WAREHOUSE PRICES ON LEAK, WHARFEDALE etc. etc.—visit your nearest RSC Hi Fi Centre

- AKAI GXC 40D Tape Unit £62.95 (Rec. Price £89.74) Carr. £1
 - AKAI 4000DS Tape Unit £68.95 (Rec. Price £97.50) Carr. £1
 - AKAI 1721L Tape Unit £66.95 (Rec. Price £104.50) Carr. £1
 - AKAI CR81D Tape Unit £58.95 (Rec. Price £84.10) Carr. £1
 - Also FREE with above GL72 Goldring G800 cartridge worth over £10 Carr. 75p
 - B.S.R. MACDONALD MP60 TYPE T/Table & P.U. £10.95 (Rec. Price £14.95) Carr. 40p
- Prices shown correct at time of going to press (24/10/73)

FANE 'MODE ONE' HIGH FIDELITY SPEAKER KIT



Incorporating a model 803 8" 13,000 Gauss Bass Speaker with ultra low resonance. P.V.C. surround cone. Printed circuit cross-over assembly with ferrite cored coils. Model 303 Pressure Tweeter, Acoustic damping material, Screws, Panels etc., and instructive diagrams, Frequency Response 25 Hz-20 kHz, 8-15Ω. Price per pair £19.99 Or Dep. £1.98 & 9 monthly payments £1.23 (Tot. £13.50)

RSC G66 MkII 6+6 WATT high quality STEREO AMPLIFIER

Individual Ganged Controls: Bass, Treble, Volume and Balance. Printed circuit construction employing 10 Transistors plus Diodes. Output rating I.H.F.M. Frequency range 20-20,000 c.p.s. Bass Control ± 12db. Treble Control ± 13db. Selector switch for P.U. or Tape/Radio. For loudspeaker output impedances of 3 to 15 ohms. For standard 200-250v. A.C. mains operation. Attractive Black and Silver finished metal fascia plate and matching control knobs. COMPLETE KIT OF PARTS INCLUDING FULLY WIRED PRINTED CIRCUIT BOARD AND INSTRUCTIONS £12.65 Carr. OR FACTORY BUILT IN TEAK VENEERED CABINET £17.85 40p as illustrated £18.50 or dep. £2.50 and 9 monthly payments £1.88 (Total £18.97).

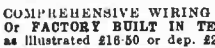

COMPREHENSIVE WIRING DIAGRAMS & INSTRUCTIONS £12.65 Carr. OR FACTORY BUILT IN TEAK VENEERED CABINET £17.85 40p as illustrated £18.50 or dep. £2.50 and 9 monthly payments £1.88 (Total £18.97).

AUDIOTRINE HIGH FIDELITY SPEAKERS



Heavy construction. Latest high efficiency ceramic magnets. Plasticised Cone surround. "D" indicates Tweeter Cone providing extended frequency range up to 15,000 c.p.s. Impedance 3 or 8-15 ohms. PLEASE STATE CHOICE. Exceptional performance at low cost.

HF808T 8" 10W 22-98	HF120D 12" 15W 45-50
HF12D 12" 10W 45-90	HF12E 12" 15W 45-85
HF180 12" 15W 44-95	HF126D 12" 15W 45-85

FANE 807T HIGH FIDELITY SPEAKER



A full range 8in. 10 watt unit for excellent sound quality. In suitable enclosure. Cast chassis Roll P.V.C. cone surround and long throw voice coil to achieve very low fundamental resonance of 30 c.p.s. Tweeter cone is fitted to extend high note response. Frequency range 25 Hz to 15 KHz. Gauss 10,000. Impedance 3 or 8-15 Ω. Post Free £3.99 PLEASE STATE IMPEDANCE REQUIRED R.R.P. £4.99 MODEL 808T 8" 15w. with parallel Tweeter. Post Free £5.50 Response 25 Hz to 15 KHz. Gauss 13,000 Imp 3 or 8-15Ω. R.R.P. £6.99

ALL R.S.C. PRICES INCLUDE VAT FULL LABOUR AND MATERIAL GUARANTEES FOR 12 MONTHS

HI-FI SPEAKER ENCLOSURES MODERN DESIGN

Teak veneer finish. Acoustically lined. Sizes approx. Carr. 35p per enclosure. J8 Size 16" x 11" x 9". SE8 For optimum performance with any 8in. Hi-Fi speaker. £6.50 Pressurised. Gives pleasing results with any 8in. Hi-Fi speaker. £5.50 Size 19 x 10 1/2 x 9in. SE12 For excellent performance with 12in. Hi-Fi speaker and tweeter Size 25 1/2 x 16 x 9in. £7.95 SE10 For outstanding results with 10in. Hi-Fi spkr. Size 25 1/2 x 16 x 9in. Ported £6.75

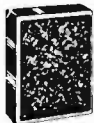

AUDIOTRINE HI-FI SPEAKER SYSTEMS

Consisting of matched 12in. 11,000 line 15 Watt 15 ohm high quality speaker, cross-over unit and tweeter. Smooth response and extended frequency range ensure surprisingly realistic reproduction. £6.50 Carr. 33p OR SENIOR 15 WATT INCLUDING HF126 15,000 LINE SPEAKER £7.65 Carr. 39p

R.S.C. TA6 6 Watt HI-FI AMPLIFIER

200-250v. AC mains operated. Frequency Response 30-20,000 c.p.s. -20B. Harmonic Distortion 0.3%, at 1,000 c.p.s. Separate Bass and Treble 'lift and cut' controls. 8 input sockets for Mike, Gram, Radio or Tape. Input selector switch. Output for 3-15 ohm spkrs. Max. sensitivity 8mV Output rating I.H.F.M. Fully enclosed enamelled case, 9 1/2 x 2 1/2 x 4 1/2 in. Attractive brushed silver finish fascia plate 10 1/2 x 3 1/2 in. and matching knobs. Complete kit of parts with full wiring diagrams and instructions. £8.50 Carr. 40p OR FACTORY BUILT WITH 12 MONTHS' GUARANTEE £12.05



R.S.C. BATTERY/MAINS CONVERSION UNITS

TYPE BML An all-dry battery eliminator. Size 5 1/2 x 4 1/2 x 2 1/2 in. approx. Completely replaces batteries supplying 1.5v and 90v. to battery radio where A.C. mains 200/250v. Post 30p 500c/s is available. ASSEMBLED READY FOR USE £4.15



R.S.C. TRANSFORMERS, L.F. CHOKES & RECTIFIERS

FULLY GUARANTEED. Impregnated and Interleaved where necessary. Primaries 200-250v. 50c/s. Screened

MIDGET CLAMPED TYPE 2 1/2 x 2 1/2 x 2 1/2 in.

250v.-60mA, 6.3v. 2a.	£1.10
250-0-250v., 60mA 6.3v. 2a.	£1.18

FULLY SHROUDED UPRIGHT MOUNTING

250-0-250v. 60mA, 6.3v. 2a., 0-5-6.3v. 2a.	£1.55
250-0-250v. 100mA, 6.3v. 4a., 0-5-6.3v. 3a.	£2.45
800-0-300v. 100mA, 6.3v. 4a., 0-5-6.3v. 3a.	£2.45
300-0-300v. 130mA, 6.3v. 4a. c.t., 6.3v. 1a.	£2.95
For Mullard 810 Amplifier	£2.95
850-0-350v. 100mA, 6.3v. 4a., 0-5-6.3v. 3a.	£2.45
850-0-350v. 150mA, 6.3v. 4a., 0-5-6.3v. 3a.	£2.95
425-0-425v. 200mA, 6.3v. 4a. c.t., 5v. 3a.	£5.45
425-0-425v. 200mA, 6.3v. 4a., 6.3v. 3a., 5v. 3a.	£5.60
450-0-450v. 250mA, 6.3v. 4a. c.t., 5v. 3a.	£6.00

TOP SHROUDED DROP-THTRO TYPE

250-0-250v. 70mA, 6.3v. 2a., 0-5-6.3v. 2a.	£1.49
250-0-250v. 100mA, 6.3v. 3-5a.	£1.71
250-0-250v. 100mA, 6.3v. 2a., 6.3v. 1a.	£1.75
350-0-350v. 60mA, 6.3v. 2a., 0-5-6.3v. 2a.	£1.81
200-0-250v. 100mA, 6.3v. 4a., 0-5-6.3v. 3a.	£2.45
300-0-300v. 100mA, 6.3v. 4a., 0-5-6.3v. 3a.	£2.45
300-0-300v. 130mA, 6.3v. 4a. c.t., 6.3v. 1a.	£2.85
Suitable for Mullard 810 Amplifier	£2.85
300-0-350v. 100mA, 6.3v. 4a., 0-5-6.3v. 3a.	£2.45
350-0-350v. 100mA, 6.3v. 4a., 0-5-6.3v. 3a.	£2.85

FILAMENT or TRANSISTOR POWER PACK

Type 6.3v. 1-ba. 55p; 6.3v. 2a. 60p; 6.3v. 3a. 85p;
6.3v. 6a. £1.45; 12v. 1a. 61p; 12v. 3a. or 24v. 1-ba. £1.50; 0-9-18v 1-ba. £1.25; 0-12-25-42v 2a2f. 95p.

SELENIUM RECTIFIERS F.W. (Bridged) All 8 1/2v. D.C. output. Max. A.C. input 18v. 1a. 25p. 2a. 39p. 3a. 55p. 4a. 72p. 5a. 88p. SMOOTHING CHOKES 150mA, 7-10H, 250 Ω 77p; 100mA Ω 77p; 100mA Ω 10H, 200 Ω 86p; 100mA, 10H, 550 Ω 56p; 60mA, 10H, 400 Ω 28p.

CHARGER TRANSFORMERS 0-9-15v. 1 1/2a. £1.10, 2 1/2a. £1.25; 3a. £1.40; 5a. £1.60; 6a. £1.85; 8a. £2.20 AUTO (Step UP/step DOWN) TRANSFORMERS 0-110/120v. 300-250-250v. 50-80 watts £1.25, 150 watts £2.10 250 watts £3.00; 500 watts £5.40 OUTPUT TRANSFORMERS Standard Pentode 5,000 Ω or 7,000 Ω to 3 Ω 55p Push-Pull 8 watts EL84 to 3 Ω or 15 Ω 95p Push-Pull 10 watts 6V8, ECL86 to 3, 5, 8 or 15 Ω £1.55 Push-Pull EL84 to 3 or 15 Ω 10-12 watts. £1.50 Push-Pull Ultra Linear for Mullard 610, etc. £2.45 Push-Pull 15-18 watts, sectionally wound 6L6, K766, etc., for 3 or 15 Ω £2.20 Push-Pull 20 watt high quality sectionally wound EL34, 6L6, KT86 etc. to 3 or 15 Ω £3.85

R.S.C. MkIII SUPER 30 HIGH FIDELITY STEREO AMPLIFIER

BUILD AN AMPLIFIER WORTH APPROXIMATELY DOUBLE THE KIT PRICE INCLUDING CABINET Only high grade components by leading manufacturers

- * Push Button Selector Switching
- * Jack Socket for Headphones
- * Neon Indicator
- * Satin Silver Finish Metal Fascia
- * Solid State Circuitry
- * Twenty Silicon Transistors
- * Four Diodes, Four Rectifiers

Send S.A.E. for full descriptive leaflet.



For Magnetic or Ceramic Pick-Ups regardless of Price. Output (per channel) 15 watts RMS into 8 Ω. Frequency Response 7 Hz to 70 KHz ± 1 1/2 dB. COMPLETE KIT (less cabinet). Carr. 70p. Cabinet if req. £5 extra. £22.50

R.S.C. STEREO FM III TUNER. IN CABINET. Visually matches Super 30 Mk. III £37.50

FACTORY BUILT UNIT INC. CABINET with 12 months' guarantee. Or Dep. £7 and 9 monthly payments £4.54 (Total £47.86) £42.50

'YORK' HIGH-FIDELITY 3 SPEAKER SYSTEM

★ Moderate size only 25 x 14 x 10in. approx. COMPLETE KIT ★ Response 30-20,000 c.p.s. Impedance 15 ohms £25.25 ★ Performance comparable with units costing considerably more Carr. 65p

Consists of (1) 12in. 15 watt Bass unit with cast chassis, Roll rubber cone surround for ultra low resonance, and ceramic magnet. (2) 3-way quarter section series cross-over system. (3) 8 x 5in. high flux middle range speaker. (4) High efficiency tweeter. (5) Appropriate quantity acoustic damping material. (6) Handsome Teak veneered cabinet. (7) Circuit and full instructions. Terms: Deposit £5.25 and 9 monthly payments £2.56 (Total £28.29).



- R.S.C. BRANCHES OPERATE A 5-DAY WEEK OPEN ALL DAY SATURDAY
- BRADFORD 10 North Parade (Closed Wed.). Tel. 25349
 - BOLTON 23 Deansgate. (Closed Wed.). Tel. 33512
 - BIRMINGHAM 30/31 Great Western Arcade. Tel. 021-238 1279 (Closed Wed.).
 - COVENTRY 17 Shelton Square, The Precinct.
 - DERBY 97 St. Peter's Street. (Closed Wed.). Tel. 41381
 - DARLINGTON 19 Northgate (Closed Wed.). Tel. 68043
 - DONCASTER 3 Queensgate, Waterdale Centre. (Closed Thurs) Tel. 229 9501
 - EDINBURGH 101 Lothian Rd. (Closed Wed.).
 - GLASGOW 326 Argyle St. (Closed Tues.). Tel. 248 4158
 - HULL 7 Whitefriargate (Closed Thurs.). Tel. 20505
 - LEICESTER 32 High Street (Closed Thurs.). Tel. 56420
 - LEEDS 5-7 County (Mecca) Arcade, Briggate. Tel. 28252
 - LIVERPOOL 73 Dale St. (Closed Wed.). Tel. 236 3573
 - LONDON 238 Edgware Road, W.2. (Closed Thurs.). Tel. 723 1629
 - MANCHESTER 60A Oldham Street (Closed Wed.). Tel. 236 2778
 - MIDDLESBROUGH 106 Newport Rd. (Closed Wed.). Tel. 47098
 - NEWCASTLE UPON TYNE 24 Newgate Shopping Centre (Closed Wed.). Tel. 21489
 - NOTTINGHAM 19/19A Market Street (Closed Thurs.). Tel. 48068
 - SHEFFIELD 13 Exchange Street (Castle Mkt. Blds. (Closed Thurs.). Tel. 480-0777
 - STOCKPORT (Closed Thurs.). Tel. 20716
 - 8 Little Underbank Sq. (Closed Thurs.). Tel. 480-0777
 - SUNDERLAND 5 Market Sq. (Closed Wed.). Tel. 70573

RINGBOARD

STANDARD P.C. BOARDS WITH I.C. ADD ON BOARDS

BY RETURN

POST FREE U.K. ONLY

NOW AVAILABLE

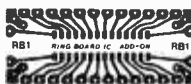
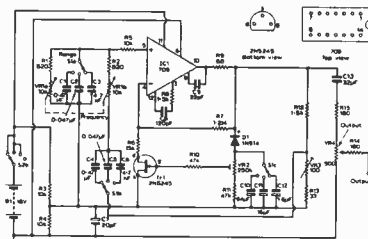

TYPE RB1 DIL



TYPE RB2 WIRE ENDED OR TAG STRIP



ADD ON MOUNTED ON RING BOARD

NOVICES

Could you build the above circuit without a circuit layout.

We think you could with **RINGBOARD** and the method supplied with each board.

EXPERIENCED CONSTRUCTORS AND LAB. TECHNICIANS

Make your work simple using ADD on I.C. boards and a good quality fibre glass standard PC flux varnished board (no cutting and little looping). Once you have used it we don't think you will find any standard PC board to compare favourably with Ringboard.

For leaflet showing and describing method please send stamped addressed envelope. **FREE!** One ¼ Board (sub standard) with the first 500 enquiries from this advertisement.

	Opening price	Actual price
Full Board	47p	55p
Half board	26p	33p
Quarter board	16p	22p

Add on board 25p each

Send to **RINGBOARD, 257 CHESTERFIELD ROAD, SHEFFIELD, YORKS, S8 0RT, Tel. 52178**

TO SPARK YOUR IMAGINATION!
the **SPARKRITE**
Electronic Ignition Kit
only **£9.35**

Kit comprises EVERYTHING
Case, cables, coil connectors,
Silicon grease,
8 page instruction leaflet.

Fascinating to build. Fantastic improvement to your car's performance. Complete Capacitive Discharge ignition system, fully proven, components fully guaranteed. Printed circuit design. All metalwork drilled ready. Fitted to car in 15 minutes when built.

- Sustained peak performance.
- Up to 20% fuel saving.
- Instant all-weather starting. Faster acceleration, higher top speed.
- Suitable for all engines up to 8 cyls.
- Longer spark plug life.
- Longer battery life.
- Contact breaker burn eliminated.
- Purer exhaust gas emission.

A new development from the manufacturers of Guntion Ignition. Price: £9.35 inc. V.A.T. and postage. (12 volt only. State Pos. or Neg. earth). Ready built unit also available £11.55 inc. V.A.T. and postage. **GUARANTEED 5 YEARS**

ORDER NOW—send P.O./Cheque direct to:
ELECTRONICS DESIGN ASSOCIATES, DEPT. PW12
82 Bath St., Walsall WS1 3DE. Phone: 33652

CASED AMPLIFIERS

Polished wooden cabinet 14 x 13 x 9" with hinged lid containing a sensitive (20µV) 4 valve amplifier with tone and vol. controls, giving 3 watts output to the 7 x 4" 3Ω speaker. Also included is a non-standard tape deck. Supplied in good working condition with cct. diagram. Mains operated. Only £3 (£1 up to 150 miles, £1.20 over). Cassettes £1 each (25p); spare heads reduced to 25p. Amplifier chassis only, complete, uses 2xECC83, EL84, EZ80 £1.65 (40p).

71b BARGAIN PARCELS

Hundreds of new components—resistors, capacitors, crystals, pots, switches, PC boards with transistors and diodes on and loads of odds and sods. Outstanding value at £1.65 (40p).

COMPUTER PANELS

31b asstd. £1 (30p); 71b £2 (40p); 561b £13 (c.p.d). 12 top quality panels containing IC's, trim pots, power transistors, etc. £2 (30p); Panels containing at least 500 parts inc. at least 50 transistors 60p (20p); Panels with 25 flatpack IC's (no info.) 30p (10p).

EX-COMPUTER EQUIPMENT (RCA 301)

Tape, ½" x 1200' on 7" NAB spool 67p (25p); 1" x 1800' on 10½" NAB spool 67p (35p); 2000µF 30V elec. 40p (25p); 35000µF 15V 40p (25p); 125 bit variable delay/line with 7 transistor amplifier 75p (10p); 25 bit ditto 60p (10p); ½" 16 track tape decks, complete with electronics in 6" cabinet £75; 240kHz 11 transistor xtal oscillator 70p (10p); Other peripherals available. 100 tag strips 50p (15p); 500 asstd. resistors £1 (20p); 5000 £8 (50p); 20000 £25 (£1); 80 + 80 + 20 = 350V cap 10p (6p) 10 for 75p (30p); 100 1 & 2% resistors 60p (12p); 150 small caps 60p (12p); 25 10X Crystals 75p (30p); 4p 8w switches 40p (10p); 2N277 (150W PNP) on small heat sink 30p (10p); 4.7µF 10V tantalum bead caps 30p doz (5p). Unit containing 2 modern c/o lever switches, 3 trim pots, R's, C's, etc. 60p (10p). Lots of junk for callers to look at. **POST IN BRACKETS; SAE LIST, ENQUIRIES.**

VAT NOT INCLUDED—ADD 10% TO TOTAL

GREENWELD ELECTRONICS (PW7)

Mail order to 24 Goodhart Way, West Wickham, Kent.
Shops at 21 Deptford Broadway, SE8 Tel. 01-692 2009 and
38 Lower Addiscombe Road, CROYDON.

look! electronics really mastered

**... practical
... visual
... exciting!**

no previous knowledge
no unnecessary theory
no "maths"

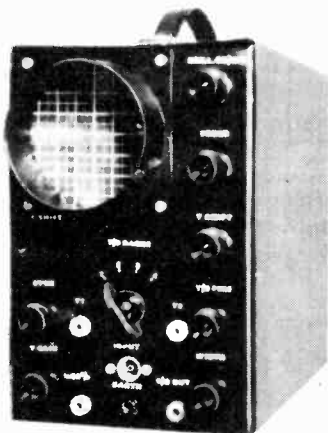
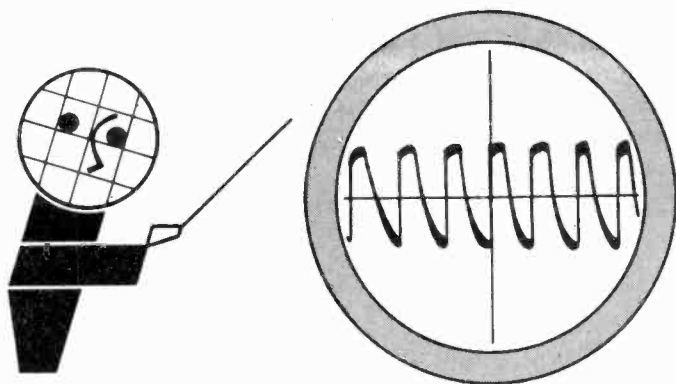

RAPY

BUILD, SEE AND LEARN

step by step, we take you through all the fundamentals of electronics and show how easily the subject can be mastered. Write for the free brochure now which explains our system.

1/ BUILD AN OSCILLOSCOPE

You learn how to build an oscilloscope which remains your property. With it, you will become familiar with all the components used in electronics.

2/ READ, DRAW AND UNDERSTAND CIRCUIT DIAGRAMS

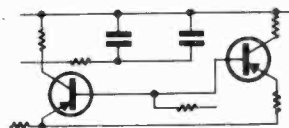

as used currently in the various fields of electronics.

3/ CARRY OUT OVER 40 EXPERIMENTS ON BASIC ELECTRONIC CIRCUITS & SEE HOW THEY WORK, including :

valve experiments, transistor experiments amplifiers, oscillators, signal tracer, photo electric circuit, computer circuit, basic radio receiver, electronic switch, simple transmitter, a.c. experiments, d.c. experiments, simple counter, time delay circuit, servicing procedures.

This new style course will enable anyone to really understand electronics by a modern, practical and visual method—no maths, and a minimum of theory—no previous knowledge required. It will also enable anyone to understand how to test, service and maintain all types of electronic equipment, radio and TV receivers, etc.

FREE POST NOW for BROCHURE

or write if you prefer not to cut page

To: **BRITISH NATIONAL RADIO & ELECTRONICS SCHOOL**, P.O. Box 156, JERSEY. Please send your free brochure, without obligation, to:

NAME

BLOCK CAPS

ADDRESS

PLEASE WL123

special free gift also to all our students

DISCOUNTS UPTO

60%

FULL 12 MONTH AFTER SALES SERVICE

with probably the best
discounts offered in the U.K.

ALL PRICES ARE INCLUSIVE OF V.A.T.

FANTASTIC OFFER GARRARD SP25 Mk III.

Goldring G800, Teak finish, plinth and tinted cover with mains lead and DIN plug and screened lead. All fully wired. Please add £1.75
£14.95
for P. & P. and Ins.

TURNTABLES

Please add 95p P & P and Ins.

BSR MP60	£9.25
Garrard SP25 Mk III	£9.95
Garrard SL65B	£12.95
Garrard AP76	£16.65
Garrard 401	£27.50
Garrard Zero 100 (sgle)	£30.95
Garrard Zero 100 (Auto)	£34.95
Goldring GL85/P. P & C	£65.95
Goldring G101/P. P & C	£21.95
Goldring GL72	£24.95
Goldring GL72/P	£31.95
Goldring GL75	£30.95
Goldring GL75/P	£38.95
Goldring GL75 Lid	£4.25
Thorens TD125	£60.95
Thorens TD125 AB Mk II	£93.95
Thorens TD160 AB & C	£31.95
Thorens TD165 AB & C	£45.95
Condor Auto Cleaner (Star Value)	£1.40 P & P 15p

TUNERS

Please add 55p P & P and Ins.

Alpha Highgate FT150	£32.95
Amstrad Multiplex 3000	£23.90
Metrosound FMS 40	£37.75
Philips RH 621	£72.95
Metrosound FMS 20 Mk II	£37.75
Rogers R/brook FET 4 (Cha)	£32.95
Rogers R/brook FET 4 (Cased)	£36.50
Sinclair cased tuner	£27.50
Teleton GT202 (N/P)	£32.95

SPEAKERS

£1.65 for P & P (Per Pair)

Amstrad Acoustra 1500	£26.90
Amstrad Acoustra 2500	£30.75
Celestion Ditton 15	£50.75
Celestion Ditton 44	£79.45
Goodmans D/Maxim	£40.95
Goodmans Mezo 3	£50.95
Goodmans Havant	£35.25
Keltron K54	£13.85
Keltron K58	£23.50
Sinclair Q16	£11.95
Sinclair Q30	£30.95
Wharfedale Denton II	£26.80

SPEAKER UNITS

Wharfedale Linton Kit	£16.85
Wharfedale Glendale Kit	£29.95
Wharfedale Unit 3	£16.30
Wharfedale Unit 4	£28.70
Wharfedale Dovedale Kit	£44.95

All prices correct at time of press (E. & O. E.) and are subject to alterations

AMPLIFIERS

Please add 95p P & P and Ins.

Amstrad 8000 Mk II	£15.85
Amstrad IC2000 Mk II	£32.15
Amstrad Integra 4000	£23.95
Alpha Highgate FA400	£39.05
Global 10 + 10	£19.75
Global 20 + 20	£25.95
Keltron 1000	£22.95
Keltron 1500	£25.75
Metrosound ST20E Mk II	£29.95
Metrosound ST60	£51.95
Rogers R/brook (Ch)	£41.15
Rogers R/brook Mk III (Ca)	£44.50
Rogers R/bourne (Ch)	£54.25
Rogers R/bourne (Ca)	£56.95
Sinclair 2000	£24.90
Sinclair 3000	£31.95
Sinclair 605	£21.45
Sinclair PRO 60 2 x Z30/PZ5	£16.40
Sinclair PRO 60 2 x Z30/PZ6	£19.45
Sinclair PRO 60 2 x Z50/PZ8 Trans	£25.25
Sinclair AFU PRO 80 (Filter Unit)	P.O.A.
Sinclair Stereo 80 Pre-amp	P.O.A.
Sinclair Z30 Amp	£3.85
Sinclair Z50 Amp	£4.50
Sinclair PZ5 Power Supp.	£4.20
Sinclair PZ6 Power Supp.	£6.15
Sinclair PZ8 Mains Trans.	£4.95
Sinclair PZ8 Power Supp.	£6.15

TUNER/AMPLIFIERS

Please add £1.10 P & P and Ins.

Alpha FR 3000	£61.35
Goodmans Module 80	£62.95
Goodmans Mod 80 Com	£109.95
Goodmans Mod. 90	£76.95
Goodmans One-Ten	£92.95
Rogers R/brook (Cha)	£61.95
Rotel 150A	£45.25
Rotel 200A	£57.95
Status STA160	£89.95

PLINTH AND COVERS

£3.35*
For Garrard SP25, 2025 TC, 3000, AP76, SL72B, SL95B, etc
£4.85 + 71p P. & P.

CARTRIDGES

Please add 11p P & P and Ins.

Goldring G850	£2.75
Goldring G800	£3.50
Goldring G800E	£6.30
Goldring G800SE	£10.90
Shure M3D	£3.25
Shure M44E	£4.95
Shure M55E	£5.00
Shure 75ED Type 2	£9.25
Shure V15	£25.95
Shure M75EJ Type 2	£7.95
Sonotone 9 AT/C	£1.20
Sonotone V 200F	£8.55
Audio Technica AT 66	£3.15
ADC 10E Mk IV	£14.95
Ronette SM S007	£5.25
Ronette SM 500IE	£7.95

AN IMAGINATIVE CHRISTMAS PRESENT
NOW YOU CAN BUILD AN **ERNIE** IN YOUR OWN HOME



LEARN THE
DIGITAL LOGIC
COMPUTER
TECHNIQUES.

A MULTIPURPOSE
ELECTRONIC DICE.
AVAILABLE AS A
COMPLETE KIT.

Build something completely out of the ordinary; something different and more exciting than everyday repeated stuff.

MINICOMP 100* is effectively a miniaturised ERNIE that displays truly RANDOM NUMBERS using brilliant NIXIE tubes; at the mere touch of a button. Four range selections are included according to the application; between 1-6 (DICE), 0-36 (ROULETTE), 1-57 (POOLS DRAWS), and between 0-99 (BINGO), (BATTLESHIPS AND ALL OTHER NUMBER GAMES). The numbers revolve round at high speed in a spectacular DICE fashion before a random number is selected and displayed. Building this fascinating ERNIE will familiarise you with sophisticated logic techniques and elements used in a digital computer.

A COMPLETE KIT includes 7 latest LOGIC I.C.'s, 3 transistors, 2 NIXIES, GLASS FIBRE printed circuit, the power supply and various other components. Elegant-sized and finished case, approx. 7" x 5" x 3". Easy to build with illustrated instructions and descriptions of the LOGIC circuits.

APPLICATIONS: With the MINICOMP it is now possible to play electronically all possible NUMBER GAMES e.g. ROULETTE, BINGO, BATTLESHIPS, CRAP DICE. An interesting application is filling in the POOLS DRAWS. The pure random nature of the DRAWS could well contribute to the winning combination.

A PROFOUND ATTRACTION FOR PARTY GAMES, FETES & BAZAARS. U.K. PRICES: COMPLETE KIT WITH ILLUSTRATED INSTRUCTIONS. Mains operated unit, 240V 50HZ or 110V 60HZ.

MINICOMP 100 £21.97, including P. & P. & V.A.T.

Fully built, tested units with a year's guarantee £24.87

TERMS: C.W.O. MAIL ORDER ONLY.

MICROELECTRONICS

MICRO

51 Mexfield Road, London SW15 2RG. Tel: 01-870 2368

* Patent applied for.

Dimmit

range of light dimmers

Illustrated is the popular PMSD1000 module.

A 1000W professional quality dimmer, linear operation, interference suppression, 60mm slider range; size 12 x 5 x 4 cm. ideal for low cost stage and disco lighting. Used by schools, theatres, studios, etc., Complete with scale plate, fixing screws and full instructions. £5.50 inc. VAT, add 10p P. & P. Also available in 2kW, with separate heatsink.

The Dimmit range includes standard wall mounting models for home and office, etc. Professional modules for use on lamps, heaters, motors etc. Rotary and Slider control versions. Ratings: 400W, 1,000W, 2,000W.

NEW addition to Dimmit range—Model SL800 sound to light converter. Modulates the light in time with sound. Built-in microphone. Just place unit near any sound source—radio, hi-fi, tv, human voice, etc. No connections to speaker required, simple wiring—similar to dimmer. Rating 800 watt, Full instructions. £6.50 inc. VAT, add 10p P. & P. Send 10p for complete illustrated catalogue and price list.

YOUNG ELECTRONICS Mail Order Dept.

54 Lawford Road, London NW5 2LN. Telephone 01-267 0201

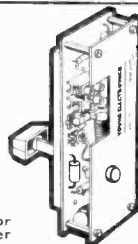

PW

Q4

PROJECT

PCB'S AND COMPONENTS
FOR THIS AND OTHER PW PROJECTS

REVERBERATION UNIT
8 WATT AMPLIFIER & PRE-AMP
LOUDHAILER PRE-AMP & SIREN GENERATOR
VIBRASONIC GUITAR PRE-AMP
DIGITRONIC DIGITAL CLOCK

AND ALSO FOR MANY P.E. PROJECTS

SEND AN S.A.E FOR OUR FREE LIST

PHONOSONICS

Dept PW12, 25 KENTISH ROAD, BELVEDERE, KENT, DA17 5BW
MAIL ORDER ONLY



GLOBAL AUDIO DISCOUNT WAREHOUSES

Dept PW12, 174 Pentonville Road, London, N1. Telephone 01-278 1769

Or: 4 High View Parade, Redbridge Lane East, Woodford Avenue, Ilford, Essex. Tel: 01-550 1086.

Open Monday to Saturday 9.30 a.m. to 6 p.m. LATE NIGHT FRIDAY 7 p.m.

MAIL ORDERS. Order with confidence. Send Postal Order, Cheque, Money Order, Bank Draft, Giro or Cash by Registered Mail. CALLERS. Please note that cheques can only be accepted together with cheque cards (not Barclay Card)

2 minutes from KING'S CROSS. EUSTON & ST. PANCRAS
on main road leading to the East and West Country

MAPLIN ELECTRONIC SUPPLIES

★ SAME DAY SERVICE



MAPLIN - Projected site of London's third airport.



Model 120

PROJECTS DESERVE A PROFESSIONAL QUALITY INSTRUMENT CASE—4 MODELS

Model 120 all aluminium two part construction. Top and sides, blue hammer finish, front, rear and base; white. Others: mild steel three part construction.

Top, base, sides and detachable rear panel, blue hammer. Detachable front panel finished in white.

Dimensions in inches.

Model	W	H	D	Price
120	8	2 1/2	4	£1.85
220	8	6	3 1/2	£2.85
221	8	6	6	£2.80
320	12	8	12	£5.00

Chassis for model 320 £1.75 extra.

Please send s.a.e. for free illustrated leaflet.

LARGE or SMALL Centurion

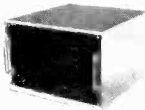

Model 320

MES announces the very latest development in organ circuitry.

THE DMO2

13 Master Frequencies on ONE tiny circuit board LOOK AT THESE AMAZING ADVANTAGES

★ 13 frequencies from C8 to C9. ★ Each frequency digitally derived from a SINGLE h.f. master oscillator. ★ Initial tuning for the WHOLE ORGAN: ONE SIMPLE ADJUSTMENT. ★ Relative tuning NEVER DRIFTS. ★ External control allows instant tune-up to other musicians. ★ Outputs will directly drive most types of dividers including the SAJ110. ★ And each output can also be used as a direct tone source. ★ Variable DEPTH AND RATE (tremulant optional extra). ★ Gold-plated plug-in edge connexion. ★ Complete three glass board (including tremulant if required) ONLY 3-7in. x 4-5in. ★ Very low power consumption.

★ EXTREMELY ECONOMICAL PRICE. ★ Ready built, tested and fully guaranteed. DMO2 (with tremulant) ONLY £14.25.

DMO2 (without tremulant) £12.25

SAJ110 7-stage frequency divider in one 14 pin DIL package. Sine or square wave input allows operation from almost any type of master oscillator including the DMO2 (when 97 notes are available). Square wave outputs may be modified to saw-tooth by the addition of a few components. SAJ110: £2.83 each OR special price for pack of 12: £25.00. S.a.e. please for data sheet.

★ S.a.e. please for full technical details.

Trade enquiries welcome.

TRANSISTORS, DIODES & IC's.

AC127	25p	BF194	15p	OA90	7p
AC128	20p	BFY51	18p	OA91	6p
AC176	17p	MPP105	36p	IN914	4p
AD149	50p	OC44	20p	IN148	4p
AD161/2	60p	OC71	20p	IN4001	6p
BC107	10p	T1843	23p	IN4002	6p
BC108	10p	2N1711	24p	IN4003	7p
BC109	10p	2N2219	25p	IN4004	7p
BC147	10p	2N2646	45p	IN4005	8p
BC148	10p	2N2905	33p	IN4006	8p
BC149	12p	2N2907	25p	IN4007	9p
BC168	13p	2N2925U	10p	WO5	30p
BC169	12p	2N2926Y	10p	WO4	35p
BC182L	10p	2N2926D	10p	741C 8-pin	33p
BC204	14p	2N3053	18p	D.I.L.	36p
BC209C	14p	2N3055	49p	741C 14-pin	45p
BD131	54p	2N3819	24p	D.I.L. sockets	20p
BD132	87p	AA119	7p	D.I.L. sockets	15p
BD131/2	£1.50	BY127	16p	8-pin	20p
BD135	35p	BY164	49p	14-pin	25p

See our catalogue for our full range of transistors. 74 series I.C.'s bridges etc.

CAPACITORS

Sub-miniature Axial lead electrolytic

Mfd V	Price	Mfd V	Price	Mfd V	Price
1.63	6p	68	6-36p	15	40
1.5-63	6p	68	16	6p	470
2-2.63	6p	68	63	10p	470
3-3.63	6p	100	4	6p	470
4-7.63	6p	100	10	6p	470
6-8.63	6p	100	25	6p	470
10	25	6p	100	63	12p
10	63	6p	150	6-3	10p
15	16	6p	150	16	6p
15	40	6p	150	25	6p
15	63	6p	150	40	10p
22	10	6p	150	63	12p
22	25	6p	220	4	6p
22	63	6p	220	10	6p
33	6-3	6p	220	16	6p
33	16	6p	220	25	10p
33	40	6p	220	40	12p
47	4	6p	220	63	18p
47	10	6p	330	4	6p
47	25	6p	330	10	6p
47	40	6p	330	16	10p
47	63	6p	330	63	22p
			4700	4	22p

PLUGS AND SOCKETS

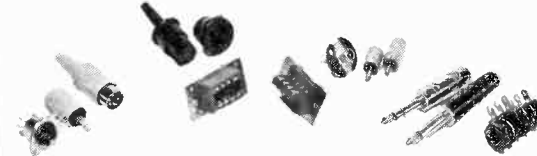

DIN PLUGS

2 pin (1 flat) 8p
3 pin 5p
4 pin, 5 pin A (180°), 5 pin B (240°), 6 pin 10p

MAINS

P360 3 pin 1.5A chassis plug with line socket. 2p
SA 2190 3 pin 5A chassis plug 17p
SA 1862 Line socket for above 19p

8mm 8 way chassis socket

52p
PEONO Plug plastic 5p
Plug screened 8p
Chassis socket 4p

Std. 1" stereo plug

Plastic 16p
Screened 25p
Open mono socket 1" 10p; Moulded mono socket 1" with 2 break contacts 13p; Moulded stereo socket 1" with 3 break contacts 18p; 3.5mm. plug plastic 8p; screened 11p; open socket 8p.

DIN Sockets

2 pin 6p
3 pin, 4 pin, 3 pin A (180°), 5 pin B (240°), 6 pin 7p

McMURDO

RPS 8 way chassis plug 36p

JACK

Std. 1" mono plug 13p
Screened 17p

WE KNOW YOU NEED IT!



The MES 1974 Catalogue is STACKED with dozens of tempting new lines. BRIMMING OVER with clear illustrations and detailed data.

AVAILABLE VERY SOON

You'll be IMPRESSED with our POST FREE ordering system, EXCITED by our BIG VALUE discount vouchers, STAGGERED by our UNBEATABLE speed of service. Take the first step towards real service NOW! Send ONLY 25p for our beautifully produced catalogue and leave the rest to us!

OMNIUM GATHERUM

PP3. 6 etc. battery clip dual min.	9p
PP1. 9 etc. battery clip separate per pair	6p
Pair crocodile clips 1 red, 1 black insulated sleeve.	7p
Solder Multicoat 22swg 10 metres	20p
Silicone grease in special dispenser 20ml	43p
Red neon 240V panel mounting	25p
Lacing Cord Strong rayon coated PVC 25m.	43p
Panel fuse holders 20mm 20p: 1"	30p
Transformers	
LT700 min. output transformer Pri. 1-2k Ω Sec. 5 Ω 200mW	35p
Sub-min. Mains Transformer 6-0-6V 100mA	95p
12-0-12V 60mA	95p
Size: Both approx. 30 x 27 x 25mm.	
Min. Mains Transformer (Size: 46 x 31 x 38mm) 0-12V 250mA, 0-12V 250mA	£1.35
Mains transformer MT3AT Pri. 200-220-240V, Sec. 12-15-20-24-30V 2A	£2.48
Mains Transformer MT306AT Pri. 200-220-240V, Sec. 0-15-20V 1A, 0-15-20V 1A	£2.95

Also in stock: Wide range of brass and nylon nuts, bolts and washers + solder tags, shakeproof washers etc.

POTENTIOMETERS

Rotary miniature carbon track 1" spindle

Single gang Lin or Log 5k, 10k, 25k, 50k, 100k, 250k, 500k, 1M, 2M (and 1k Lin) 12p



Dual gang

(Stereo) without switch Log or Lin 5k to 2M as above 38p.

Single gang with DP switch

250V 2A Log or Lin 5k to 2M as above 23p

PRESETS

Sub-miniature 0-1W Vert or Horiz 100, 250, 500, 1k, 2.5k, 5k, 10k, 25k, 50k, 100k, 250k, 500k, 1M 6p

Wirewound 10%, 1W 4" spindle 10, 50, 100R 34p; 250, 500, 1k, 5k 33p; 10k, 37p; 25k 40p; 50k 44p.

RESISTORS

Carbon Film 1/4W 5% 1Ω to 1M; 10% 1/2M to 10M	E12	1p
Carbon Film 1/4W 5% 1Ω to 10Ω; 10% 1/2M to 10M	E12 & E24	1p
Carbon Film 1/4W 5% 10Ω to 10M	E12 & E24	1p
Metal Oxide 1/4W 2%, 10Ω to 1M	E12 & E24	3p
Wirewound 1/4W 10%, 0-22ohms to 0-47ohms	E12	10p
Wirewound 1/4W 5%, 1ohm to 27ohms	E12	10p

E12 values 10, 12, 15, 18, 22, 27, 33, 39, 47, 56, 68, 82 and decades
E24 values 11, 13, 16, 20, 24, 30, 36, 43, 51, 62, 75, 91 and decades

KNOBS

All 1" shaft. Grab screw fixing

Diameter shown in brackets

K30/1 (13mm)	K30/3 (17mm)	K30/2 (13mm)	HK12 32mm long, black pointer with white stripe 6p	K30/6 (32mm)	41p
F18 (26mm) with numbered skirt 21p	F12 (33mm) 21p	MK50 (34mm) 27p	CK4 (35mm) 14p		

SWITCHES

Rotary with adjustable stop 1 pole 2 to 12 way; 2 pole 2 to 6 way; 3 pole 2 to 4 way; 4 pole 2 or 3 way, each 24p
Mains rotary DPDT 250V 2A 20p.

Push to make non-locking 12p	Slide Mixture DPDT 8p
Foggle 250V 1-3A with ON/OFF plate 25p.	Sub-miniature toggle DPDT (12 x 12.5 x 14mm excl. toggle) 250V 3A 61p

VAT

Please add 10% to the final total.

Post & packing FREE in U.K. (10p handling charge on orders under 50p.)

Orders and enquiries for catalogues to MAPLIN ELECTRONIC SUPPLIES, P.O. Box 3, Rayleigh, Essex. PHONE SOUTHDEN (0702) 44101

THE G.W.S. SMITH & CO (RADIO LTD)

AUDIOTRONIC MODEL ATM.1

Top value 1000 o.p.v. pocket multimeter. Ranges: 0/10/50/250/1000V. AC and DC. DC Current 0-1mA/100mA. Resistance 0/160k ohms. Decibels -10 to +22dB. Size 90 x 60 x 28mm. Complete with test leads. £2.95. Post 15p.



RUSSIAN 22 RANGE MULTIMETER

Model U437 10,000 o.p.v. A first class versatile instrument manufactured in U.S.S.R. to the highest standards. Ranges: 2.5/10/50/250/1000/1000V D.C. 2.5/10/50/250/1000/1000V A.C. DC Current 100mA/1/10/100mA/1A. Resistance 300 ohms/3/30/300k/3MΩ. Complete with batteries. test leads, instructions and sturdy steel carrying case. £4.95. P. & P. 25p.



MODEL TE-200

20,000 O.P.V. Mirror scale. overload protection. 0/5/25/125/1,000V. D.C. 0/10/50/250/1,000V. A.C. 0/50/250/1,000V. A.C. 0/50/250/1,000V. A.C. 0/60k/6 megΩ. -20 to +62db. £4.95. P. & P. 15p.



MODEL TE-300

30,000 O.P.V. Mirror scale. overload protection 0/5/15/50/100/200V. D.C. 0/10/50/250/1000V. A.C. 0/50/250/1000V. A.C. 0/10k/100k/1MΩ. 80k/800k/8 megΩ ohm. -20 to +62 db. £7.50. P. & P. 15p.



U4312 MULTIMETER

Extremely sturdy instrument for general electrical use. 667 o.p.v. 0/31.5/75/300/1500/3000/800/800 V DC and 75mV. 0/31.5/75/300/1500/3000/800V A.C. 0/300µA/1.5/6/150/600mA/1.5/6 AMP. D.C. 0/1.5/6/15/60/150/600mA/1.5/6 AMP. A.C. 0/200Ω/3k/30kΩ. Accuracy DC 1%, AC 1.5%. Knife edge pointer, mirror scale. Complete with sturdy metal carrying case, leads and instructions. £9.75. P. & P. 25p.



MODEL 50V

30,000 O.P.V. with overload protection. mirror scale. 0/5/25/100/250/500/1,000V. D.C. 0/2.5/10/25/100/250/500/1,000V. A.C. 0/50µA/5/50/500mA. 12 amp. I.C. 0/40k/8 MegΩ. 60 MegΩ. £10.50. Post paid. Leather Case £1.75



MODEL C-7080 EN

Giant 0° mirror scale. 20,000 o.p.v. 0/25/11/2.5/10/50/250/1000/5000V. D.C. 0/2.5/10/50/250/1000/5000V. A.C. 0/50µA/1/10/100/300mA/10 amp. D.C. 0/2K/200K/20 megΩ -20 to +50 dB. £13.95. Post 35p.



Model 5-100TR MULTIMETER/TRANSISTOR TESTER

100,000 o.p.v. mirror scale/overload protection. 0/12/8/3/12/30/120/600 V DC. 0/6/30/120/800 V. A.C. 0/12/600µA/12/300mA/15 AMP. DC 0/10 K/1 MΩ/100MΩ. -20 to +50db. 0.01-2 MPD. Transistor tester measures Alpha, beta and Ico. Complete with batteries, instructions and leads. £14.95. P/P 25p.



KAMODEN 72.200 MULTIMETER

High sensitivity tester. 200,000 o.p.v. Overload protection. Mirror scale. Ranges: 0/1.05/3/3/3/30/120/600/1200V. D.C. 0/3/12/60/300/11,200V. A.C. 0/6µA/1.2mA/120mA/600mA/12A. D.C. 0/12A. A.C. -20 to +63db. 0/2K/200K/2 megΩ/200 meg ohms. £16.95. Post 30p.



TMK LAB TESTER.

100,000 O.P.V. 63in. Scale Buzzer Short Circuit Check. Sensitivity: 100,000 O.P.V. 5K/5k/Volt A.C. D.C. Volts: 5, 2.5, 10, 50, 250, 1,000 V. A.C. Volts: 3, 10, 50, 250, 500, 1,000V. D.C. Current: 10, 100µA, 100, 1000µA, 2.5, 10 amp. Resistance: 1K, 10K, 100K, 1MΩ, 10MΩ. Decibels: -10 to +49 db. Plastic Case with Carrying Handle. Size: 77in. x 63in. x 37in. £19.95. P. & P. 25p.

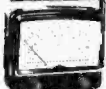

HIQI MODEL 700X

100,000 O.P.V. Overload protection. Mirror scale. 3/6/1-2/1-5/5/8/12/30/60/120/300/600/1200V DC 15/3/8/12/30/60/150/300/600 1200V A.C. 15/30µA/3/8/30/60/150/300mA 0/12/20/200K/20MΩ/2 megΩ/20 Meg ohm. -20 to +63dB. £14.95. P. & P. 20p.



370 WTR MULTI-METER

Features A.C. current ranges. 20,000 o.p.v. 0/2.5/10/50/250/500 1000 V. D.C. 0/2.5/10/50/250/500/1000V AC 0/50µA/1/10/100mA/1/10 AMP. D.C. 0/30mA/1/10 Amp AC 0/5K/50K/500K/5 megΩ/50 meg. -20 +62db. £17.50. P. & P. 25p.



KAMODEN HM 350 TRANSISTOR TESTER

High quality instrument to test Reverse Leak current and DC current. Amplification factor of NPN, PNP, transistors, diodes. SCR's etc. 4" x 4" clear scale meter. Operates from internal batteries. Complete with instructions, leads and carrying handle. £12.50. Post 30p.



MODEL 449A IN-CIRCUIT TRANSISTOR TESTER

Checks true A.C. beta in/out. Checks Ico. Checks diodes in/out. Checks SCR, etc. Beta 111 10 - 500, LO 2 - 50. Ico. 0-5000µA. 220/240 V A.C. operation £17.50. Post 25p.



LB3 TRANSISTOR TESTER

Tests Ico and B. PNP & NPN. Operates from 9v battery. Complete with all instructions, etc. £3.95. P. & P. 20p.



LB4 TRANSISTOR TESTER

Tests PNP or NPN transistors. Audio indication. Operates on two 1.5v batteries. Complete with all instructions, etc. £4.50. P. & P. 20p.



TE-40 HIGH SENSITIVITY A.C. VOLT-METER

10 meg. input 10 ranges. 0.01/0.1/1/3/10/30/100/300V. R.M.S. 5cps-1.2 Mc/s. Decibels -40 to +60dB. Supplied brand new complete with leads and instructions. Operation 230V. A.C. £17.50. Carr. 25p.



TE-65 VALVE VOLT-METER

28 ranges D.C. volts 1.5-1,500V. A.C. volts 1.5-1,500V. Resistance up to 1,000 megohms. 200/240V. A.C. operation. Complete with probe and instructions. £17.50. P. & P. 30p. Additional probes available. R.F. £2-12; H.V. £2-50.



MODEL AT201 DECADE ATTENUATOR

Frequency range 0-200KHz. Attenuator 0.111db, 0.1db step. Impedance 600 ohms. Max. input power 300dbm. Size 180 x 90 x 55mm. £12.50. Post 37p.



KAMODEN HM. 720B F.E.T. V.O.M.

Input impedance 10 meg ohms. Ranges: 0/25/1/2.5/10/50/250/1000V. D.C. 0/2.5/10/50/250/1000V. A.C. 0/25µA/2.5/25/250 mA D.C. 0/25 to +62dB 0/5K/50K/500K/5meg 500meg ohms. £14.95. Post 30p



TMK MODEL 117 P.E.T. ELECTRONIC VOLTMETER

Battery operated, 11 meg input, 26 ranges. Large 4 1/2" mirror scale. Size 6 1/2" x 4 1/2" x 2 1/2". DC VOLTS 0.3-1200V 0/5K/10K/2-300V R.M.S. 8.0-800V P-P. DC CURRENT 12-12mA. Resistance up to 2000M ohm. Decibels -20 to +51dB. Complete with leads/instructions. £17.50. P. & P. 20p.



KAMODEN HMG-500 INSULATION RESISTANCE TESTER

Range 0-1000 Meg-ohms. 500 Volt. Battery operated. Wide range clear meter 4 1/2" x 4 1/2". Complete with deluxe carrying case, batteries, instructions. £19.95. Post 30p



BELCO AF-5A SOLID STATE SINE SQUARE WAVE C.R. OSCILLATOR

Sine 18 x 290,000 Hz; Square 18 x 20,000 Hz. Output max. +10 dB. (10 K ohms) Operation: Internal batteries Attractive 2-tone case 7 1/2" x 5" x 2 1/2". Price £17.50. Carr. 17p.



TO-3 PORTABLE OSCILLOSCOPE

3in. tube, Y amp. Sensitivity 0.1v p-p/CM. Bandwidth 1-5 cps-1.5 MHz. Input imp. 2 megΩ 25pF X amp. sensitivity 0.9v p-p/CM. Bandwidth 1-5cps-800kHz. Input imp. 2 megΩ 20pF. Time base. 6 ranges 10 cps 300 kHz. Synchronization. Internal/external. Illuminated scale 140 x 215 x 320 mm. Weight 15lb. 220/240V. A.C. Supplied brand new with handbook. £52.50. Carr. 50p.



CI-5 PULSE OSCILLOSCOPE

For display of pulsed signals in electronic circuits. VERT. AMP. Bandwidth 10MHz. Sensitivity at 100KHz VRMS/nm. -1.25; HOR. AMP. Bandwidth 600KHz. Sensitivity at 100KHz V. RMS/nm. -3.25; Preset trigger and sweep, 1-3,000µsec.; free running 20-200,000Hz in nine ranges. Calibrator pips. 220 x 360 x 430mm. 115-230V. AC operation. £39.00. Carr. paid.



RUSSIAN CI-16 DOUBLE BEAM OSCILLOSCOPE

5 Mc/s Pass Band. Separate Y1 and Y2 amplifiers. Rectangular 5in. x 4in. C.R.T. Calibrated triggered sweep from 2 µsec. to 100 milli-sec. per em. Preset timing time base 50 cps-1 mc/s. Built-in time base calibrator and amplitude calibrator. Supplied complete with all accessories and instruction manual. £87. Carr. Paid.



TE-16A TRANSISTORISED SIGNAL GENERATOR

5 ranges 400KHz-30MHz. An inexpensive instrument for the handyman. Operates on 9V battery. While easy to read scale 800KHz modulation. 5 1/2 x 5 1/2 x 3 1/2. Complete with instructions and leads. £8-97. Post 25p.



MODEL U4311 SUB-STANDARD MULTI-RANGE VOLT AMMETER

Sensitivity 330 ohms/Volt AC and DC. Accuracy 0.5% D.C. 1%. AC. Scale length 165mm. 0/300/750µA 1-5/3/7.5/15/30/75/150/300/750mA/1.5/3/7.5/15/30/75/150/300/750V. AC. 0/3/7.5/15/30/75/150/300/750V. DC. 0/750mV/1.5/3/7.5/15/30/75/150/300/750V. D.C. 0/750mV/1.5/3/7.5/15/30/75/150/300/750V. D.C. Current: 25, 50µA, 2.5, 5, 25, 50, 500mA, 5, 10amp. Resistance: 10K, 100K, 1 MEG, 10 MEG Ω. Decibels: -20 to 481-5db £8-50. P. & P. 17p.



TMK MODEL TW-50K

46 ranges, mirror scale. 50K/Volt. D.C. 5k/Volt A.C. D.C.: Volts 125, 25, 1-25, 2.5, 5, 10, 25, 50, 125, 250, 500, 1000V. A.C. Volts: 1.5, 3, 5, 10, 25, 50, 125, 250, 500, 1000V. D.C. Current: 25, 50µA, 2.5, 5, 25, 50, 250, 500mA, 5, 10amp. Resistance: 10K, 100K, 1 MEG, 10 MEG Ω. Decibels: -20 to 481-5db £8-50. P. & P. 17p.



MODEL TE.15 GRID DIP METER

Transistorised. Operates as Grid Dip, Oscillator Absorption Wave Meter and Oscillation Detector. Frequency range 440Kc/s-280Mc/s in 6 coils. 500µA Meter. 9V battery operation. Size 180 x 90 x 40mm. £15.00. Post 20p.



ARF-300 AF/RF SIGNAL GENERATOR

All transistorised, compact, fully portable. AF signal generator. 18 Hz to 220 KHz. AF square wave 18 Hz to 100 KHz. Output sine / square 10v. P-P. RF 100 KHz to 200 MHz. Output 1v. maximum. Operation 220/240V. A.C. Complete with instructions and leads. £29.95. Post 60p.



TE22 SINE SQUARE WAVE AUDIO GENERATORS

Sine: 20cps to 200 kc/s on 6 bands. Square: 20cps to 30 kc/s. Output impedance 6,000 ohms. 200/250V. A.C. operation. Supplied brand new and guaranteed with instruction manual and leads. £17.50. Carr. 37p.



240° Wide Angle 1mA Meters

MW 1-6 60mm square £3-97 MW 1-8 80mm square £4-97 P. & P. 15p.

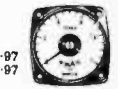

POWER RHEOSTATS

High quality ceramic construction. Windings embedded in vitreous enamel. Heavy duty brush wiper. Continuous rating. Wide range available ex-stock. Shure hole fixing. 4in. dia. shafts. Bulk quantities available. 25 WATT. 10/25/50/100/250/500/1000 ohms. £1-15 P. & P. 10p. 50 WATT. 10/25/50/100/250/500/1000/2500 or 5000 ohms. £1-62 P. & P. 10p. 100 WATT. 15/10/25/50/100/250/500/1000 or 2500 ohms. £2-34. P. & P. 15p.



AUTO TRANSFORMERS

0/115/250V. Step up or step down. Fully shrouded. 80 W £2-35 P. & P. 18p 150 W £3-00 P. & P. 18p 300 W £4-00 P. & P. 23p 600 W £5-80 P. & P. 33p 1000 W £8-25 P. & P. 38p 1500 W £11-25 P. & P. 45p 2250 W £19-00 P. & P. 50p 5000 W £40-00 P. & P. £1

ALL PRICES ARE SUBJECT TO 10% VAT

HIGH QUALITY CONSTRUCTION KITS
Appointed stockists at all branches

Complete with comprehensive, easy to follow instructions, and covered by full guarantee.
Post and packing 15p per kit

AF20 Mono transistor amplifier	£4.80
AF30 Mono transistor pre amplifier	£2.61
AF10 Mono amplifier kit for stereo	£5.91
A15 Automatic light control	£2.58
AT30 Photo cell switching unit	£5.70
AT50 400W Trac light dimmer speed control	£4.80
AT55 1,300W Trac light dimmer speed control	£5.70
AT56 2,300W Trac light dimmer speed control	£6.90
AT60 Psychoelectric light control, single channel	£7.80
AT65 Psychoelectric light control, 3 channel	£14.55
HE61 Medium wave 1 transistor radio	£3.33
HF75 FM transistor receiver	£7.88
HF310 FM tuner unit	£15.81
HF325 De Luxe FM tuner unit	£24.12
HF330 Stereo decoder for HE310/HE325	£9.96
HF395 Aerial amplifier for AM/FM bands I, II, III	£1.77
GP310 Stereo pre-amp for use with 2x AF210	£21.27
GU210 Terminal unit for guitars etc	£7.50
NT10 Power supply 100 mA 9V stab 12V unstab	£6.55
NT100 Professional stabilised power supply, 2x 30 Volt 2.2 Amp	£12.51
NT305 Transistor converter 12/15V AC DC to 6V, 7.5V or 9V DC	£4.50
NT310 Power supply 240V AC to 2x 18V DC at 2 Amps	£19.87
NT315 Power supply 240V AC to 4x 15V DC 500 mA	£4.50

NEW FROM JOSTY KIT!

'Amateur Electronics'—The professional hook for the amateur—covers the subject from basic principles to advanced electronic techniques.

OUR PRICE £30.00, complete with circuit board for making the kits listed below.

A E1 100mV output stage	£1.65
A E2 Pre-amplifier...	£1.26
A E3 Diode-receiver	£2.00
A E4 Flasher	£1.09
A E5 Astable multivibrator	£1.05
A E6 Monostable multivibrator	£1.02
A E7 RC generator	£1.06
A E8 Base filter	99p
A E9 Treble filter	99p
A E10 CCIR filter	99p

230 VOLT A.C. 50 CYCLES RELAYS

3 sets of changeover contacts at 5 amp rating, 40p each. P. & P. 12p/100 lots £30. Quantities available.



"YAMABISHI" VARIABLE VOLTAGE TRANSFORMERS

Excellent quality at low cost. All models—Input 230V. 50/60 c/s. Variable output 0-260V.

MODEL S-260 GENERAL PURPOSE BENCH MOUNTING

1 Amp	8/75	30p
2.5 Amp	10/00	35p
5 Amp	14/70	37p
8 Amp	19/55	50p
10 Amp	28/10	75p
12 Amp	29/50	100p
20 Amp	61/25	126p
25 Amp	72/50	150p
40 Amp	103/10	160p

MODEL S-260B Panel Mounting.

1 Amp	8/75	30p
2.5 Amp	10/00	35p

Carriage and Packing Extra

REFLEX HORN SPEAKER RUH.6

Built in driver unit. Impedance 16 ohm. Power rating 10 watt. Response 380-7000Hz. Approx. size 6" x 6". Weatherproof and shock proof.

OUR PRICE £4.97 P. & P. 30p.



BVD.5 VERNIER TUNING DIAL

Approx. 7-1 ratio planetary drive vernier dials. Log scale 0-180 degrees. Blank scales 1 to 5. Scale width .41". Dial size 6" x 3". Overall size 7 1/2" x 4 1/2" x 1 1/2" deep including knob and coupling. 1" dia. shaft.

OUR PRICE £1-62 P. & P. 15p.



MP7 MIXER PREAMPLIFIER

5 microphone inputs each with individual gain controls enabling complete mixing facilities. Battery operated. 9 1/2" x 6 1/2" x 3 1/2". Inputs Mics: 3 x 3mV 50K; 2 x 3mV 600 ohm. Phono meg. 4mV 50K. Phono ceramic 100mV 1 meg. Output 250mV 100K.

Our Price £8-97 P. & P. 20p



SEW CLEAR PLASTIC PANEL METERS
USED EXTENSIVELY BY INDUSTRY, GOVT. DEPTS., EDUCATIONAL AUTHORITIES, ETC.
Over 200 ranges in stock—other ranges to order. Quantity discounts available. Send for fully illustrated brochure.

Type SW.100 100 x 80 mm.		Type MR.85P. 4 1/2in. x 4 1/2in. fronts		Type MR.38P. 1 21/32in. square fronts	
50μA	£4-15	100mA	£2-90	200mA	£2-25
50-500μA	£4-15	500mA	£2-90	500mA	£2-25
100μA	£3-95	1 amp.	£2-90	1000mA	£2-25
100-1000μA	£3-90	5 amp.	£2-90	750mA	£2-25
600μA	£3-70	15 amp.	£2-90	1 amp.	£2-25
1mA	£3-60	30 amp.	£2-90	2 amp.	£2-25
20V. D.C.	£3-60	10V D.C.	£2-90	5 amp.	£2-25
50V. D.C.	£3-60	20V. D.C.	£2-90	10 amp.	£2-25
300V. D.C.	£3-60	60V. D.C.	£2-90	2V. D.C.	£2-25
1 amp. D.C.	£3-60	150V. D.C.	£2-90	10V. D.C.	£2-25
		300V. D.C.	£2-90	50V. D.C.	£2-25
		15V. A.C.	£2-95	20V. D.C.	£2-25
		300V. A.C.	£2-95	50mA	£2-25
		8 Meter 1mA	£2-90	500μA	£2-25
		8 Meter 10mA	£2-90	100μA	£2-25
		VU Meter	£2-90	100-1000μA	£2-40
		1 amp. A.C.*	£2-90	200μA	£2-25
		5 amp. A.C.*	£2-90	600μA	£2-25
		10 amp. A.C.*	£2-90	500-5000μA	£2-25
		20 amp. A.C.*	£2-90	1mA	£2-25
		30 amp. A.C.*	£2-90	10-1mA	£2-25
				1mA	£2-25
				10-1mA	£2-25
				10V. D.C.	£2-25
				50V. A.C.	£2-20
				100V. A.C.	£2-20
				300V. A.C.	£2-20
				500V. A.C.	£2-20
				1000mA	£2-20
				500mA	£2-20
				100mA	£2-20
				50mA	£2-20
				20mA	£2-20
				10mA	£2-20
				5mA	£2-20
				2mA	£2-20
				1mA	£2-20
				500μA	£2-20
				100μA	£2-20
				10-1000μA	£2-25
				200μA	£2-75
				600μA	£2-75
				5 amp. D.C.	£2-60
				10 amp. D.C.	£2-60
				20 amp. D.C.	£2-60
				50 amp. D.C.	£2-60
				100 amp. D.C.	£2-60
				200 amp. D.C.	£2-60
				500 amp. D.C.	£2-60
				1000 amp. D.C.	£2-60
				1 amp. A.C.*	£2-60
				5 amp. A.C.*	£2-60
				10 amp. A.C.*	£2-60
				20 amp. A.C.*	£2-60
				30 amp. A.C.*	£2-60
				50 amp. A.C.*	£2-60
				100 amp. A.C.*	£2-60
				200 amp. A.C.*	£2-60
				500 amp. A.C.*	£2-60
				1000 amp. A.C.*	£2-60
				1 amp. A.C.*	£2-60
				5 amp. A.C.*	£2-60
				10 amp. A.C.*	£2-60
				20 amp. A.C.*	£2-60
				30 amp. A.C.*	£2-60
				50 amp. A.C.*	£2-60
				100 amp. A.C.*	£2-60
				200 amp. A.C.*	£2-60
				500 amp. A.C.*	£2-60
				1000 amp. A.C.*	£2-60

Type SD.830 82.5mm x 110mm Fronts

10mA	£2-10
50mA	£2-10
100mA	£2-10
500mA	£2-10
1mA	£2-10
5 amp.	£2-10
10 amp.	£2-10
5V. D.C.	£2-10
10V. D.C.	£2-10
20V. D.C.	£2-10
50V. D.C.	£2-10
300V. D.C.	£2-10
15V. A.C.	£2-10
300V. A.C.	£2-10
VU Meter	£2-60

Type SD.640 63.5mm x 85mm Fronts

50μA	£2-05
100-1000μA	£2-05
100μA	£2-00
100-1000μA	£2-00
200μA	£2-00
600μA	£2-00
1mA	£2-00
5 amp.	£2-00
10 amp.	£2-00
5V. D.C.	£2-00
20V. D.C.	£2-00
50V. D.C.	£2-00
300V. D.C.	£2-00
15V. A.C.	£2-00
300V. A.C.	£2-00
VU Meter	£2-15

Type MR.45P. 2in. square fronts

50μA	£2-70
50-500μA	£2-65
100μA	£2-60
100-1000μA	£2-60
200μA	£2-60
600μA	£2-60
1mA	£2-60
5 amp.	£2-60
10 amp.	£2-60
5V. D.C.	£2-60
15V. A.C.	£2-60
300V. A.C.	£2-60
8 Meter 1mA	£2-60
8 Meter 10mA	£2-60
VU Meter	£2-70
1 amp. A.C.*	£2-60
5 amp. A.C.*	£2-60
10 amp. A.C.*	£2-60
20 amp. A.C.*	£2-60
30 amp. A.C.*	£2-60

"SEW" EDUCATIONAL METERS

Type ED.107. Size overall 100mm x 90mm x 108mm

A new range of high quality moving coil instruments ideal for school experiments and other bench applications. 3" mirror scale. The meter movement is easily accessible to demonstrate internal working. Available in the following ranges:

50μA	£2-90	15V d.c.	£2-95
100μA	£2-40	20V. d.c.	£2-95
50-500μA	£2-40	50V. d.c.	£2-95
1mA	£2-95	300V. d.c.	£2-95
1-0-1mA	£2-95	Dual range	
1A d.c.	£2-95	500mA/5A d.c.	£2-00
5A d.c.	£2-95	1/15A d.c.	£2-00
5V d.c.	£2-95	5V/150V d.c.	£2-00
10V d.c.	£2-95	5/150V d.c.	£2-00

Type MR.52P. 2 1/2in. square fronts

50μA	£2-60
50-500μA	£2-05
100μA	£2-00
100-1000μA	£2-05
200μA	£2-65
1mA	£2-60
5 amp.	£2-60
10 amp.	£2-60
5V. D.C.	£2-60
10V. D.C.	£2-60
20V. D.C.	£2-60
50V. D.C.	£2-60
300V. D.C.	£2-60
15V. A.C.	£2-60
300V. A.C.	£2-60
8 Meter 1mA	£2-60
8 Meter 10mA	£2-60
VU Meter	£2-60
5 amp. A.C.*	£2-60
10 amp. A.C.*	£2-60
20 amp. A.C.*	£2-60
30 amp. A.C.*	£2-60

Type MR.65P. 3 1/2in. x 3 1/2in. fronts

50μA	£2-70
50-500μA	£2-15
100μA	£2-10
100-1000μA	£2-10
200μA	£2-65
600μA	£2-75
1mA	£2-60
5 amp.	£2-60
10 amp.	£2-60
5V. D.C.	£2-60
15V. A.C.	£2-60
300V. A.C.	£2-60
160V. A.C.	£2-60
300V. A.C.	£2-60
500V. A.C.	£2-60
8 Meter 1mA	£2-65
8 Meter 10mA	£2-60
VU Meter	£2-70
50mA A.C.	£2-60
100mA A.C.	£2-60
200mA A.C.	£2-60
500mA A.C.	£2-60
1 amp. A.C.*	£2-60
5 amp. A.C.*	£2-60
10 amp. A.C.*	£2-60
20 amp. A.C.*	£2-60
30 amp. A.C.*	£2-60
50 amp. A.C.*	£2-60
100 amp. A.C.*	£2-60
200 amp. A.C.*	£2-60
500 amp. A.C.*	£2-60
1000 amp. A.C.*	£2-60

"SEW" EDGWISE METERS

Type PE.70. 3 1/2in. x 1 1/2in. x 1 1/2in. deep

50μA	£2-75
50-500μA	£2-60
100μA	£2-60
100-1000μA	£2-60
200μA	£2-60
600μA	£2-60
1mA	£2-60
5 amp.	£2-60
10 amp.	£2-60
5V. D.C.	£2-60
15V. A.C.	£2-60
300V. A.C.	£2-60
VU Meter	£2-85

***MOVING IRON— ALL OTHERS MOVING COIL**
Please add postage



Type SD.460 46mm x 59.5mm Fronts

50μA	£2-80
50-500μA	£2-80
100μA	£2-75
100-1000μA	£2-75
200μA	£2-70
600μA	£2-55
1mA	£2-60
5 amp.	£2-60
10 amp.	£2-60
5V. D.C.	£2-60
10V. D.C.	£2-60
20V. D.C.	£2-60
50V. D.C.	£2-60
300V. D.C.	£2-60
15V. A.C.	£2-60
300V. A.C.	£2-60
500V. A.C.	£2-60
1000V. A.C.	£2-60
1 amp. A.C.*	£2-60
5 amp. A.C.*	£2-60
10 amp. A.C.*	£2-60
20 amp. A.C.*	£2-60
30 amp. A.C.*	£2-60

"SEW" BAKELITE PANEL METERS

Type MR.65. 3 1/2in. square fronts

2 amp.	£2-60
5 amp.	£2-60
15 amp.	£2-60
30 amp.	£2-60
60 amp.	£2-60
5V. D.C.	£2-60
10V. D.C.	£2-60
20V. D.C.	£2-60
50V. D.C.	£2-60
100V. D.C.	£2-60
300V. D.C.	£2-60
500V. D.C.	£2-60
60V. V.D.C.	£2-90
30V. A.C.*	£2-65
50V. A.C.*	£2-65
150V. A.C.*	£2-65
300V. A.C.*	£2-65
500V. A.C.*	£2-65
1 amp. A.C.*	£2-60
5 amp. A.C.*	£2-60
10 amp. A.C.*	£2-60
20 amp. A.C.*	£2-60
30 amp. A.C.*	£2-60
50 amp. A.C.*	£2-60
VU Meter	£2-65

Type S-80 80 mm. square fronts

50μA	£2-80
50-500μA	£2-80
100μA	£2-80
100-1000μA	£2-80
200μA	£2-80
600μA	£2-80
1mA	£2-80
1-0-1mA	£2-80
10mA	£2-80

G.W.S. G.W. SMITH & CO. (RADIO) LTD

UR-1A RECEIVER



4 Bands covering 550Kc/s-30 Mc/s. FET, 8 Meter. Variable BFO for 88B. Built-in Speaker, Bandspread, Sensitivity Control, 220/240 v. A.C. or 12 v. D.C. Brand new with instructions.
Our Price £25.00 Carr. 37p

TRIO 9R59DS RECEIVER



4 bands covering 550 Kc/s to 30 Mc/s continuous and electrical bandspread on 10, 15, 20, 40 and 80 metres. 8 valve plus 7 diode circuit. 4/8 ohm output and phone jack. 88B-CW, ANL, Variable BFO. 8 meter. Sep. bandspread dial. IF frequency 445 kc/s, audio output 1.5w. Variable RF and AF gain controls 115/250 v. A.C. with instruction manual.
Our Price £49.50 Carr. Paid

TRIO JR599 RECEIVER



9 wavebands covering 1.8-29.7MHz 144-146MHz and 10-00MHz V.W.V. 88B, CW, AM and FM. AF output more than 1 watt. 8 Meter. Squelch control. BFO. Variable RF and AF controls. 4-18 ohm output and phone jack. Power requirements 100/240v. AC. 12-14v. DC. Size 270 x 140 x 810mm.
Our Price £155.00 Carr. Paid

BELTEK W5400 CAR TRANSCEIVER



Solid state mobile transceiver for 12v DC neg. use. Transmits and Receives on any 12 of 28 channels between 144 and 146MHz. Power output 10w and 1w switchable. Controls: Volume/on/off, squelch channel selector, Internal 3" speaker. Complete with dynamic mike, PTT switch, three sets of crystals for 144-48MHz, 144-60 MHz, 145-00MHz, mounting bracket and instructions. Size approx. 160 x 70 x 220mm.
Our Price £75.00 P & P 50p

TRIO JR310 SSB RECEIVER



Covers 3-5, 7, 14, 21, 28, 28.5 and 29.1 MHz bands and V.W.V. 16MHz. 88B, AM and CW. AF output more than 1 watt. Crystal controlled BFO for 88B. 8 meter. ANL etc. AC 110/120-220/240v. Size 380 x 179 x 810mm.
Our Price £75.00 Carr. Paid

UNR 30 RECEIVER

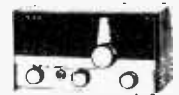

4 Bands covering 550 Kc/s-30 Mc/s B.F.O. Built-in Speaker 220/240 v. A.C. Brand new with instructions.
Our Price £15.75 Carr. 37p

LAFAYETTE HA-600 RECEIVER



General coverage 160-300 Kc/s, 560 Kc/s-30 Mc/s, FET front end, 2 mech. filters, product detector, variable B.F.O., noise limiter, 8 Meter Bandspread, RF Gain, 220/240 v. A.C. or 12 v. D.C. Brand new with instructions.
Our Price £50.00 Carr. 50p

TRIO TR2000 TRANSCEIVER



Fully transistorized portable VHF Transceiver. Will transmit and receive on 6 channels between 144-146MHz. 1 watt transmitter. 12v DC internal or external supply. Built in charger for ni-cad cells. Power/volume switch, squelch control, channel selector, mike socket, earphone/external speaker socket. Complete with microphone, 144.8, 144.72 and 145.32 crystals. Size 134 x 58 x 180mm.
Our Price £79.50 Carr. Paid

TRIO TS515/PSS15 TRANSCEIVER



High quality T8515 88B/CW amateur band receiver covering 80, 40, 20, 15 and 10 metre bands with P8515 power supply and speaker unit. Transmit/receive frequency 3.5-29.7MHz. Output 1.5 watts. Power requirements 110-120/220-240v. AC. Sizes: T8515 330 x 185 x 340mm. P8515 200 x 168 x 349mm.
Our Price £210.00 Carr. Paid

SWR METER—Model SWR-3

Handy SWR Meter for transmitter antenna alignment, with built-in field strength meter. Accuracy: 5%. Impedance: 52. Indicator: 100µA DC, full scale 5 section collapsible antenna. Size: 145 x 60 x 60 mm.
OUR PRICE £4.25 P. & P. 25p

AUDIOTRONIC AMR-900 GLOBAL AM/FM PORTABLE RADIO



10 wavebands covering AM: 535-1605 KHz, LW: 150-380 KHz, MB 1.6-4.00 MHz, BW1: 4.0-8 MHz, SW2: 8.0-1.6 MHz, SW3: 16-24 MHz, P8B1: 30-50 MHz, P8B2: 148-174 MHz, FM 88-108 MHz, AIR: 108-138 MHz. Features time zone map and timing dial. Large clear scale. Telescopic aerial and built-in serial. AFC or FM. 6" x 4" speaker and personal earpiece. Battery/mains operation. Size: 845 x 133 x 806mm.
OUR PRICE £36.00 P. & P. 50p.

SH628 STEREO HEADPHONES



Outstanding value. Soft ear-pads, adjustable headband. 8-16 ohms, 20-20,000 Hz. Complete with lead and stereo plug.
Our Price £1.87 P. & P. 30p

LHO25 STEREO HEADPHONES



Lightweight headphones with padded earpieces. 4-16 ohms, 20-20,000 Hz. Complete with 6 ft. cord and plug.
Our Price £1.97 P. & P. 30p

TEI018 DE-LUXE MONO HIGH IMPEDANCE HEADSET



Sensitive magnetic headset with soft earpads. Impedance 2,600 ohms (d.c. 800 ohms). Frequency response 20-4,000 Hz.
Our Price £2.25 P. & P. 30p

BH.001 HEAD SET AND BOOM MICROPHONE



Moving Coil. Ideal for language teaching, communications. Headphone imp. 16 ohms. Microphone imp. 200 ohms.
Our Price £4.95 P. & P. 30p

DH025 STEREO HEADPHONES



Wonderful value and excellent performance combined. Adjustable headband. 8 ohm impedance, 20-12,000 cps. Complete with lead and plug.
Our Price £2.25 P & P 30p

HAND-HELD 2-WAY WALKIE-TALKIES



SKYPON—100MW. 224.95 pair, F802—2 CHANNEL 300MW. 428.50 pair. P1003—3 CHANNEL 1 Watt 271.25 pair. LICENCE REQUIRED FOR OPERATION IN U.K.

AUDIOTRONIC DIGITAL CLOCK RADIO ADC.1



Covers AM 540-1600 KHz, FM 88-108 MHz with AFC illuminated dial. 24 hour alarm setting. Wake up to the sound of music or loud buzzer. Sleep switch will automatically turn off radio etc. Internal speaker plus socket for earpiece or pillow speaker. AC 240v. Size 264 x 92 x 178mm. Complete with earpiece, and operating instructions.
OUR PRICE £12.50 P. & P. 50p.

SPECIAL BARGAIN! PHONIC 10 TWO WAY SPEAKER SYSTEM



Matched pair of compact, hockeystick speakers of unique design incorporating 2" high frequency tweeter and 6" woofer. 8 ohms impedance. 10 watts power handling. Size 348 x 228 x 110mm.
GWS SPECIAL PRICE £9.95 per pair. P. & P. 60p plus VAT.

AUDIOTRONIC AM101 STEREO HEADPHONE AMPLIFIER



All silicon transistor amplifier operates from magnetic, cellular or other inputs with twin stereo headphone outputs and separate volume controls for each channel. Operates from 9v battery. INPUTS: 50mV/100mV. OUTPUT: 50mV per channel.
Our Price £7.50 P. & P. 20p

AUDIOTRONIC AR.1000 SPORTSMAN AM/FM POLE BRTRADIO



5 wavebands covering AM 535-1065KHz, FM 88-108MHz, AIR 108-135MHz, PB 147-174MHz, WB 162.5MHz. Large horizontal slide d in with logging scale. Slider volume and squelch controls. 7 section telescopic aerial for FM and built in ferrite bar for AM. AFC. 3in. speaker. Earpiece socket. Size 152 x 79 x 219mm. Battery/mains operation.
OUR PRICE £11.50 P. & P 35p.

AUDIOTRONIC AMB.500 MULTIBAND RADIO



5 wavebands covering MW 535-1605KHz and FM 88-174MHz. All transistor. Battery or mains operation. Built in serial and 8 section telescopic aerial.
 Complete with batteries, shoulder strap and earpiece.
OUR PRICE £6.95 P & P 35p

BINATONE D5100 DIGITAL CLOCK RADIO



240v. mains operation. Large dial with large clear numbers for hours, minutes and seconds. Approx. size 61" x 8" x 81".
OUR PRICE £4.50 P. & P. 80p.

AUDIOTRONIC ACP.8 8 TRACK CAR PLAYER



12v neg. earth. Slider controls for Volume, Tone and Balance. Channel selector button with red pilot lamp, with speakers, mounting brackets and instructions.
Our Price £12.50 P & P 40p

AUDIOTRONIC DOLBY 'B' NOISE REDUCTION UNITS



Reduce tape hiss by 3dB at 600Hz, 6dB at 1200Hz and 10dB for all frequencies above 3000Hz. Size 161" x 8" x 31". AC 200/250v

PROCESS FOUR

For use with semi-professional tape recorders. Freq. res. 30Hz-20KHz ± 2dB. S/N better than 70dB. Full source tape monitoring. Record/Replay metering. Switchable multiplex filter. Supplied with test tape.
Our Price £50.00 P & P 50p

PROCESS TWO

For use with cassette and tape recorders. Freq. res. 30Hz-20KHz ± 2dB. Off tape monitoring. Switchable multiplex filter. Two Dolby calibration meters. S/N better than 70dB. Supplied with test cassette or tape as required.
Our Price £34.50 P & P 50p

FM TUNER CHASSIS



8 TRANSISTOR HIGH QUALITY TUNER. S I Z E ONLY. Double tuned discriminator. Ample output to feed most amplifiers. Operates on 9v battery. Coverage 88-108Mc/s. Ready built ready for use. Fantastic value for money.
Our Price £5.95 P. & P. 20p

A1018 FM TUNER



Specification as above chassis but complete in cabinet with on/off switch. Size 7 1/2" x 3 1/2" x 5".
Our Price £9.65 P & P 30p
 Stereo multiplex adaptor 24.97

AUDIOTRONIC AM/FM Portable Radio AR3000



4 wavebands covering FM 87-108 MHz, MW 510-1605 KHz, LW 145-285 KHz, SW 5.8-12.5 MHz. Push button wave change plus AFC and on/off. Thumb wheel tuning. Slider volume and tone controls. Earphone socket, Built-in and telescopic aerials. Car aerial socket. Battery/Mains operation.
OUR PRICE £14.95 P. & P. 50p

AUDIOTRONIC ACR3500 CAR RADIO



Manual tuning of Medium and Long waves. 12v pos. or neg. earth. Complete with speaker, mounting brackets and instructions.
Our Price £6.50 P & P 50p



SAVE UP TO 33 1/3% OR MORE! GIVE

SUPER AKAI HI-FI BARGAINS CS35 Stereo Cassette Recorder

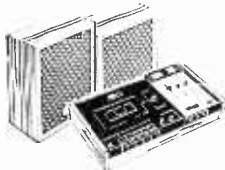

For conventional or Chromium Dioxide tape. 4 track record/playback. Volume and tone controls. Frequency response 40-16kHz (using CrO2 tape), distortion better than 2%, wow and flutter better than 0.2% RMS. Complete with pair of matching Akai CS88 speakers.

Rec. Price £99-10 **£56.50** P. & P. 50p
OUR PRICE 50p
MICROPHONES (P. & P. 50p)
ADM Dynamic (pair) £7-50

AUDIOTRONIC AHP-8D 8 Track Stereo Tape Deck

Can be used with most hi-fi amplifiers. Push button track selector and illuminated track indicators. Attractive cabinet with black and silver trim. Output level 750mV. AC 220/240V.
OUR PRICE **£11.95** P. & P. 50p.



AUDIOTRONIC AHP-8A 8 Track Stereo Tape Player

Incorporates built in amplifiers giving 2 1/2 + 2 1/2 watts rms output. Push button track selector, illuminated track indicators, slider controls for volume, balance and tone. Attractive cabinet with black and silver trim. Output impedance 8 ohms. AC 220/240V.
OUR PRICE **£17.25** P. & P. 50p.



SPECIAL PURCHASE! BSR 8 TRACK PLAYER CHASSIS

Famous BSR 8 track chassis as used in Model TD8S complete with silver and black escutcheon ready to fit into cabinet. Output 125mV. AC 240V. Overall size approx. 185 x 215 x 40mm.
OUR PRICE **£8.95** P. & P. 50p.

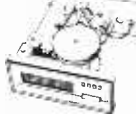

AUDIOTRONIC ACD.660 Stereo Cassette Deck



A beautifully styled 4 track stereo deck with an outstanding specification offered at a remarkably low price. Incorporates a host of features including switchable noise filter normal/chrome tape selector, twin VU meter, slider record/playback level controls, front panel headphone socket, recording indicator lamp, phono/Din line input sockets, 3.5mm mike input sockets etc. Frequency response 100-8KHz (100-12KHz CrO2) 8/N-45dB. Crosstalk 46dB. Separation-35dB. Noise limiter-ndB at connecting leads.
OUR PRICE **£39.50** Carr. & Ins. 50p

AUDIOTRONIC ACR.14 Battery Mains Cassette Recorder

Portable twin track mono recorder with automatic recording level control. Built in speaker. Earpiece socket. Input for radio or record player. Fast forward and rewind. Output 500mW. AC 220/240V or 10V DC operation. Complete with remote control microphone, mains lead, earpiece and batteries.
OUR PRICE **£10.50** P. & P. 50p.



PORTABLE CASSETTE RECORDER CT5050

Instant recording and playing. Piano key controls. Automatic level control. Built in speaker. Complete with remote control microphone, carrying case and shoulder strap
OUR PRICE **£8.50** P. & P. 50p.



AUDIOTRONIC LOW NOISE CASSETTES

Top Hi-Fi quality in library cases

TYPE	5	10	25
C60	£1.29	£2.53	£5.99
C90	£1.85	£3.62	£8.99
C120	£2.29	£4.48	£10.68

P. & P. 15p.
Cassette Tape Head Cleaner 80p

3-STATION INTERCOM KE.630

Master and two sub stations. Can be used on desk or wall mounted. Complete with cable and batteries.
OUR PRICE **£5.25** P & P 50p



MINUTEMAN MM3 POCKET CALCULATOR

Size only 4 1/4" x 3" x 1". 8 digit display with overflow and error indicators. Floating decimal. Adds, subtracts, multiplies and divides. Chain and mixed calculations. Constant factor for series multiplication or division. Complete with batteries, instructions and case.
OUR PRICE **£23.95** P. & P. 25p

MINUTEMAN MM3M

as above with addition of memory key, per cent key and a fixed or floating decimal. Complete with rechargeable batteries, AC adaptor, instructions and case.
OUR PRICE **£28.50** P. & P. 25p

NEW! SINCLAIR CAMBRIDGE CALCULATOR

To build yourself. Complete kit of parts with step by step instructions to build a full specification pocket sized calculator.
OUR PRICE **£24.95** P. & P. 50p.
(Also available ready built Rec. Price £29.95)
OUR PRICE **£27.20** P. & P. 25p



AUDIOTRONIC Stereo Headphones

- LSH.20 Individual volume controls Stereo mono switch. 8 ohms. 40-19,000 Hz. £8-50 P & P 30p
- LSH.30 Open back type. Individual tone and volume controls. 8 ohms. 30-20,000 Hz. £5-50 P & P 30p
- LSH.40 Two way speaker system. Individual volume controls. 8 ohms. 20-20,000 Hz. £9-95 P & P 30p
- LSH.60 3" speaker units. 8 ohms. 20,000 Hz. Complete with zip lead carrying case. £8-50 P & P. 30p
- LQH.400 4-channel dynamic head-phones. Each ear-piece has 4 drive units. 4-32 ohms. 20-20,000 Hz. £9-95 P. & P. 30p
- LSH.50 Electrostatic with self powered energiser and control unit with headphone/speaker selector. 4-32 ohms. 20-24,000 Hz. £15-95 P. & P. 30p



RECORD DECKS

- Carriage and Packing 50p
- B.S.R. McDONALD**
- C114 Mini
 - C120 Mono
 - C137
 - 510/TPD1
 - 610
 - 610/TPD1
 - 710
 - 810
 - MP60
 - MP60/G800
 - MP60/TPD1
 - MP60/TPD2
 - HT79 III
 - HT70/G800
 - HT70/TPD1
- CONNOISSEUR**
- BD1 Kit
 - BD1 Chassis
 - BD2/8AU2/Chassis
 - BD2/8AU2/Plinth/Cover
- GARRARD**
- 2025 T
 - 2025TC/K840A
 - SP25 III/G800
 - SP25/M75-6
 - AP76
 - 868B
 - SL65B
 - SL72B
 - SL65B
 - 401
 - ZERO 100A
 - ZERO 100S
 - Zero 100 SB
- GOLDRING**
- G99
 - G101P/C
 - GL69/2
 - GL72
 - GL72/P
 - GL75
 - GL75/P
 - GL75E
 - GL75P
 - GL78P/C
 - GL86P/C

RECORD DECK PACKAGES

- Complete units with Stereo cartridge ready wired in plinth cover.
- GARRARD**
- 2025 TC/9TAH800
 - SP25 III/G800
 - SP25 III/M44E
 - SP25 III/M44-7
 - SP25 III/M65E
 - SP25 III Module/M75-6
 - AP76/G800
 - AP76/G800E
 - AP76/M44E
 - AP76/M44-7
 - AP76/M65E
 - AP76/M75ED
 - AP76/M75EJ
 - AP76 Module M75-6
 - 868B Module/M75-68M
 - AP96 Module M75-6
 - ZERO 100S Module/M98E
 - ZERO 100SB Module M75-68M/244-90
- B.S.R. McDONALD**
- 210/SCTM
 - MP60/G800
 - MP60/TPD1/G800
 - MP60/M44-7
 - HT70/TPD1/G800
- GOLDRING**
- GL72/G800
 - GL75/G800
 - GL75/G800E
 - GL78/G800
 - GL78/G800E

New Sinclair Hi-Fi Modules

- PROJECT 80
- Z40
- Z60
- STEREO 80
- AFU
- PZ8
- PZ8
- PZ8 Mains transformer
- Project 60S

DIGITAL CLOCK MECHANISM DT.55B



Features 24 hour alarm setting with built-in buzzer. On/off and auto alarm 'sleep' switch. Illuminated rotary dial with hours, minutes and seconds. Automatically turns off TV, radio, light, etc. and with auto setting will switch on again when required. AC 240v. operation. Switch rating 250v. 3A.
OUR PRICE **£5.95** P. & P. 30p.

EMI LOUDSPEAKERS

- Model 350. 13" x 8" with single tweeter/crossover. 20-20,000 Hz. 15 watt RMS. Available 8 or 15 ohms. £7-25 each. P. & P. 37p.
- Model 450. 13" x 8" with twin tweeter/crossover. 55-13,000 Hz. 8 watt RMS. Available 8 or 15 ohms. £3-62 each. P. & P. 25p.

SPECIAL OFFER! STEREO SPEAKERS

Matched pair of stereo bookshelf speakers. Deluxe 'Leak Direct recording finish. Size 14 1/2" x 9" x 7 1/2". 8 ohms. 8 watt RMS. Complete with DIN lead.
OUR PRICE **£12.95** Carr. 50p

SPECIAL OFFER! FRUSTRATED EXPORT ORDER PHILCO FORD MODEL 5245 MAINS TAPE RECORDER

2 track BSR deck with push button controls for easy operation. Tape counter and volume control. Complete with hand microphone. Direct recording lead, 1200' reel of tape & spare spool. 200/250V AC operation. Fully guaranteed.
OUR PRICE £17-50. C & P 75p.

PHILCO FORD MODEL 5248 MAINS TAPE RECORDER

4 track, 2 speeds (3 1/2 i.p.s.) and 1 1/2 i.p.s.). Piano key type controls, tape counter, recording level meter, volume & tone controls etc. Complete with hand microphone, direct recording lead, 1800' of tape with spare spool. 200/250V AC operation fully guaranteed.
OUR PRICE £27-50. C & P 75p.

LONDON'S LARGEST STOCKS INCLUDING PRODUCTS BY -

ARMSTRONG
CAMBRIDGE
KEF LUX NIKKO
SANSUI-SANYO
SONY TEAC
TRANSCRIPTORS
TRIO UHER
YAMAHA

Prices on request or send S.A.E. for full Discount List

ALL EQUIPMENT IS FULLY GUARANTEED AND COVERED BY 12 MONTHS FREE SERVICE!

G.W. SMITH & CO (RADIO) LTD

PERSONAL CALLERS WELCOME AT ANY OF OUR RETAIL BRANCHES

CENTRAL LONDON

- 257/8, Tottenham Court Rd. W.1. Tel: 01-580 0670
- 10, Tottenham Court Rd. W.1. Tel: 01-237 2232
- 27, Tottenham Court Rd. W.1. Tel: 01-536 2715
- 87, Tottenham Court Rd. W.1. Tel: 01-540 3729
- 21, Old Compton Street, W.1. Tel: 01-437 9389
- 3, Lisle Street, W.C.2. Tel: 01-437 8204
- 34, Lisle Street, W.C.2. Tel: 01-437 9155
- 110, Edgware Road, W.2. Tel: 01-723 9786
- 183, Edgware Road, W.2. Tel: 01-723 4211

SURREY

- 311, Edgware Road, W.2. Tel: 01-262 0387
- 382, Edgware Road, W.2. Tel: 01-723 4194
- 152/3, Fleet Street, E.C.4. Tel: 01-383 2333
- 77, Watney Road, W.A. S85E. Tel: 01-268 8530
- 58, South Street, Romford. Tel: Romford 20218
- 1049, Whitgift Centre, Croydon. Tel: 01-881 3027
- 27, East Street, Kingston. Tel: 01-548 7845
- 32, Hill Street, Richmond. Tel: 01-948 1441

ALL BRANCHES OPEN 9 a.m. - 6 p.m. MONDAY TO SATURDAY

HEAD OFFICE AND MAIL ORDER DEPARTMENT
UNIT 4, THE HYDE INDUSTRIAL ESTATE, THE HYDE, LONDON NW9 6JW
TELEPHONE 01-205 3735

PRICES SUBJECT TO 10% VAT
Order with confidence by Post-but remember to add 10% VAT to total value of order including carriage and packing and send cash with order PLEASE PRINT NAME & ADDRESS CLEARLY IN CAPITALS

TELEPHONED ORDERS ACCEPTED FROM ACCESS AND BARCLAYCARD HOLDERS

CREDIT TERMS FOR PERSONAL CALLERS (on sales of £50 and over)

All prices correct as at 28-10-78 but subject to change without notice & C.E.

DABAR MN3 MIXER KIT

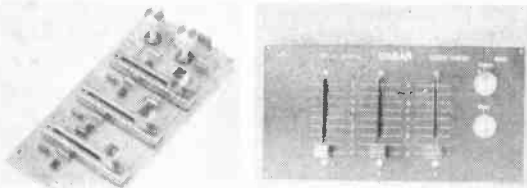

INTRODUCING THE NEW DABAR MINI THREE CHANNEL MIXER KIT WITH THE FOLLOWING FEATURES:

- ★ Three inputs easily adjustable to suit users input requirements, e.g., Mic., Tape, Disc., etc.
- ★ Uses advanced design with five integrated circuits.
- ★ Slider fader volume controls mount directly on P.C. board.
- ★ Full range bass and treble controls.
- ★ Guaranteed top grade components with fibreglass printed circuit board, ready-drilled and tinned.
- ★ Battery operated (2 x PP3) not supplied with kit.
- ★ Easy to follow assembly instructions (available separately 25p).
- ★ Attractive ready punched facia plate, available at extra cost, gives that professional finish to the unit.
- ★ Size: 9.5" x 4.8" x 2".

PRICE: KIT ONLY £11.00
 FACIA PLATE £1.50
 MANUAL AND ASSEMBLY INSTRUCTIONS 25p
 AVAILABLE READY BUILT WITH FACIA £15.00

ALL PRICES INCLUDE V.A.T. & POSTAGE IN U.K.
 S.A.E. ALL ENQUIRIES.

DABAR ELECTRONIC PRODUCTS

98, LICHFIELD STREET, WALSALL, STAFFS, WS1 1UZ.

TRANSISTORISED F.M. tuner head with A.M. gang, slow motion drive. 88-108Mcs, with circuit diagram. £2.30p.

P-C BOARDS (not computer panels)

- 1 off 6 transistors single wave band
- 1 off 4 transistor audio
- 1 off 3 transistor £1.60 the three.

10 COMPUTER PANELS packed with components including one panel with 2 Power Transistors. £1.00.

LIGHT DEPENDENT RESISTORS (RCA sq3536) 30p each, 4 for £1.00.

All Transistor STEREOGRAM CHASSIS. Medium, Long and VHF/FM. 3 Watts per channel S/M rating. With circuit service manual. Less tuning scale which can be obtained from well known British manufacturer . . . £20.

Colour Translator panels, as used on well known British E.V.R. Teleplayer. All new panels and components. Type and contents of transistors listed below. Each panel £3.50 each.

- X605. .14 off BC148. 2 RCA ca3054(ic). 1 crystal 4.433618MHz.
- Z607. .12 off BC148. 1 BC158. 1 BC108. 1 RCA ca3046. 1 RCA ca3045(ic).
- Z608. .23 off BC148. 2 BC158.
- Z612. .12 off ME4102. 2 BC251B. 1 BFY50.

CRYSTAL CALIBRATOR (Second Hand) No. 10 crystal controlled heterodyne wave-meter covering 500KHz-10MHz (harmonics up to 30MHz) power required 300V DC 15mA. 12V 0.3A DC. Test equipment for 62T M/RC. £2.50 each.

WIRE-WOUND RESISTORS. Our selection of mixed Ohms and Watts. 25 for £1.50, 50 for £2.50, parcel of 1,000 £30.00.

ALL ITEMS INCLUDE VAT

All items post paid in GREAT BRITAIN

SURPLECTRONICS

216 LEAGRAVE ROAD, LUTON, LU3 1JD, BEDS.

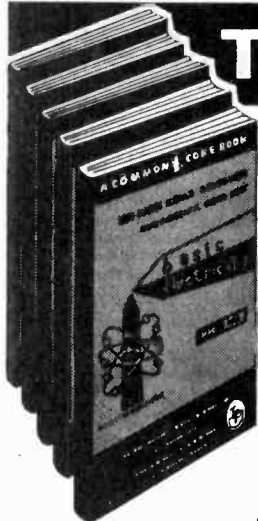

The Pictorial Method

BASIC ELECTRICITY (5 vols) ELECTRONICS (6 vols) TELEVISION (3 vols)

You'll find it easy to learn with this outstandingly successful PICTORIAL METHOD. The essential facts are explained in the simplest language, one at a time, and each is illustrated by an accurate cartoon-type drawing. These clear and concise illustrations make study a real pleasure. The books are based on the latest research into simplified learning techniques. This easy-approach-to-learning method has proved beyond doubt that acquiring knowledge can be an enjoyable experience.

YOUR
100%
 GUARANTEE

Should you be, in any way dissatisfied with the MANUALS your money will be refunded by return of post.

The series will be of exceptional value in training mechanics and technicians in Electricity, Radio and Electronics.

WHAT READERS SAY

Amazed to see so much information and in such a self-explanatory way.

S.F. Huddersfield

Your valuable assistance has enabled me to find a good position as a Radio and T.V. Engineer.

D.S. Bristol

They live up to your publicity in every way.

C.L.L. London

"BEST I HAVE EVER SET EYES ON", shall definitely recommend to friends.

F.C. Fife.

To The SELRAY BOOK CO., 60 HAYES HILL, HAYES, BROMLEY, KENT. BR2 7HP

Please find enclosed P.O./Cheque value £.....

BASIC ELECTRICITY 5 parts £4.50

BASIC ELECTRONICS 6 parts £5.40

BASIC TELEVISION 3 parts £3.60

Tick Set(s) required. Prices include Postage and Packing.

YOUR 100% GUARANTEE. If after 10 days examination you decide to return the Manuals your money will be refunded in full.

NAME
 BLOCK LETTERS

FULL POSTAL.....

ADDRESS

POST NOW FOR THIS OFFER!

NEW EDU-KIT MAJOR

Completely Solderless Electronic Construction Kit
Build these projects without soldering iron or solder

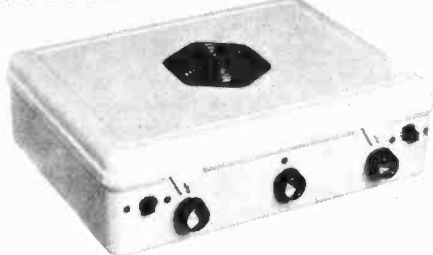

Total Building Costs
£7-23 P P & Ins. 44p
(Overseas P & P £1-85)
(+ 10% VAT 72p)

- ★ 10 Transistors
- ★ 31" Loudspeaker
- ★ 4 Transistor Earpiece Radio.
- ★ Signal Tracer.
- ★ Signal Injector.
- ★ Transistor Tester NPN-PNP.
- ★ 4 Transistor Push Pull Amplifier.
- ★ 5 Transistor Push Pull Amplifier.
- ★ 7 Transistor Loudspeaker Radio MW/LW.
- ★ 5 Transistor Short Wave Radio.
- ★ Electronic Metronome.
- ★ Electronic Noise Generator
- ★ Batteryless Crystal Radio.
- ★ One Transistor Radio.
- ★ 2 Transistor Regenerative Radio.
- ★ 3 Transistor Regenerative Radio.
- ★ Audible Continuity Tester.
- ★ Sensitive Pre-Amplifier.
- ★ Parts Price List and Plans 40p (Free with parts).

Components include 24 Resistors, 21 Capacitors, 10 Transistors, 31" loudspeaker, Mica Baseboard, 3 12-way connectors, 2 Volume controls, 2 Slider Switches, 1 Tuning Condenser, 3 Knobs, Ready Wound MW/LW/FW Coils, Ferrite Rod, 6 1/2 yards of wire, 1 yard of sleeving etc. Plans 50p.

NEW ROAMER NINE

WITH V.H.F. INCLUDING AIRCRAFT



Nine Transistors, 9 Tuneable wavebands as Roamer Ten Built in ferrite rod aerial for MW/LW. Retractable chrome-plated telescopic aerial for VHF and SW. Push Pull output using 600 mW transistors. 9 Transistors and 3 diodes, tuning condenser with V.H.F. section, separate coil for aircraft, moving coil loudspeaker, volume ON/OFF and wavechange. Attractive all white case with red grille and carrying strap. Size 9 1/2" x 7" x 2 1/2" approx. Parts Price List and Plans 30p (Free with parts).

Total Building Costs
£6-95 P P & Ins. 44p
(Overseas P & P £1-85)
(+ 10% VAT 20p)

NEW Everyday Series

Build this exciting New series of designs

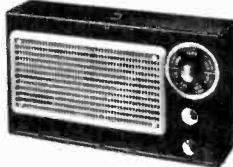

E.V.5. 5 Transistors and 2 diodes. MW/LW. Powered by 4 1/2 volt Battery. Ferrite rod 3" aerial, tuning condenser, volume control, and loudspeaker. Attractive case with red speaker grille. Size 9" x 5 1/2" x 2 1/2" approx. Parts Price List and Plans 15p. Free with parts.

Total Building Costs
£2-73 P P & Ins. 30p
(+ 10% VAT 37p)
(Overseas P & P £1-25)

E.V.6. Case and looks as above. 6 Transistors and 3 diodes. Powered by 9 volt battery. Ferrite rod aerial, loudspeaker, etc., MW/LW coverage. Push Pull output. Telescopic aerial for short waves. 3" Loudspeaker. Parts Price List and Plans 15p. Free with parts.

Total Building Costs
£3-60 P P & Ins. 30p
(+ 10% VAT 36p)
(Overseas P & P £1-25)

E.V.7. Case and looks as above. 7 Transistors and 3 diodes. Six wavebands, MW/LW, Trawler Band, SW1, SW2, SW3, powered by 9 volt battery. Push Pull output. Telescopic aerial for short waves. 3" Loudspeaker. Parts Price List and Easy Build Plans 20p. Free with parts. Overseas P & P £1-05.

Total Building Costs
£4-08 P P & Ins. 31p
(Overseas P & P £1-85)
(+ 10% VAT 40p)

ROAMER EIGHT Mk I

NOW WITH VARIABLE TONE CONTROL



7 Tuneable Wavebands: MW1, MW2, LW, SW1, SW2, SW3 and Trawler Band. Built in Ferrite Rod Aerial for MW and LW. Retractable chrome plated Telescopic aerial for Short Waves. Push pull output using 600mW transistors. Car aerial and Tape record sockets. Selectivity switch. Air spaced ganged tuning condenser. Volume/on/off, tuning, wave change and tone controls. Attractive case in rich chestnut shade with gold blocking. Size 9 x 7 x 4 1/2 in. approx. Easy to follow instructions and diagrams. Parts price list and plans 25p (FREE with parts).

Total building costs
£6-98 P P & Ins. 47p
(Overseas P & P £1-85)
(+ 10% VAT 69p)

POCKET FIVE

3 Tuneable wavebands. M.W. LW, and Trawler Band, 7 stages, 5 transistors and 2 diodes, supersensitive ferrite rod aerial, moving coil loudspeaker, attractive black and gold case. Size 5 1/2" x 1 1/2" x 3 1/4" approx. Plans and Parts Price List 15p (Free with parts).

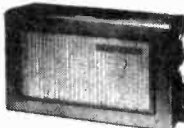

Total Building Costs
£2-28 P P & Ins. 26p
(Overseas P & P £1-25)
(+ 10% VAT 22p)



TRANSONA FIVE

Wavebands, transistors and speaker as Pocket Five. Larger Case with Red Speaker Grille and Tuning Dial. Plans and Parts Price List 15p (Free with parts).

Total Building Costs
£2-50 P P & Ins. 26p
(+ 10% VAT 25p)

(Overseas P & P £1-25)

TRANS EIGHT 8 TRANSISTORS and 3 DIODES

6 Tuneable Wavebands: MW, LW, SW1, SW2, SW3 and Trawler Band. Sensitive ferrite rod aerial for M.W. and L.W. Telescopic aerial for Short Waves. 3in. Speaker. 8 improved type transistors plus 3 diodes. Attractive case in black with red grille, dial and black knobs with polished metal inserts. Size 9 x 5 1/2 x 2 1/2 in. approx. Push pull output. Battery reconisour switch for extended battery life. Ample power to drive a larger speaker. Parts price list and plans 25p (FREE with parts).

Total building costs
£4-48 P P & Ins. 33p
(+ 10% VAT 44p)
(Overseas P & P £1-25)

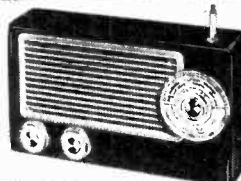

ROAMER SIX

CASE AND LOOKS AS TRANS-EIGHT

6 Tuneable Wavebands: MW, LW, SW1, SW2, Trawler band plus an extra Medium waveband for easier tuning of Luxembourg, etc.. Sensitive ferrite rod aerial and telescopic aerial for Short Waves. 3in. Speaker. 8 stages-6 Transistors and 2 diodes. Attractive black case with red grille, dial and black knobs with polished metal inserts. Total building costs £3-98 (Overseas P & P £1-85) (+ 10% VAT 39p)

ROAMER TEN

WITH VHF INCLUDING AIRCRAFT

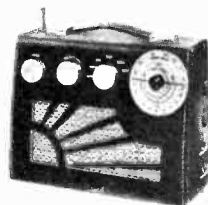

10 Transistors. 9 Tuneable Wavebands, MW1, MW2, LW, SW1, SW2, SW3, Trawler Band, VHF and Local Stations also Aircraft Band. Latest 4" 2 watt ferrite magnet loudspeaker.

Built in Ferrite Rod Aerial for MW/LW. Retractable, chrome plated 7 section Telescopic Aerial, can be angled and rotated for peak short wave and VHF listening. Push Pull output using 600mW Transistors. Car Aerial and Tape Record Sockets. 10 Transistors plus 3 Diodes. Ganged Tuning Condenser with VHF section. Separate coil for Aircraft Band. Volume on/off. Wave Change and tone Controls. Attractive Case in black with silver blocking. Size 9" x 7" x 4". Easy to follow instructions and diagrams. Parts price list and plans 30p (FREE with parts).

Total building costs
£8-50 P P & Ins. 52p
(Overseas P & P £1-85)
(+ 10% VAT 85p)



"EDU-KIT"

Build Radios, Amplifiers, etc. from easy stage diagrams.

Five units including master unit to construct.

Components include:

Tuning Condenser: 2 Volume Controls: 2 Slider Switches: Fine Tone 3" Moving Coil Speaker: Terminal Strip: Ferrite Rod Aerial: 2 Plugs and Sockets: Battery Clips: 4 Tag Boards: 10 Transistors: 4 Diodes: Resistors: Capacitors: Three 1/2" Knobs. Units once constructed are detachable from Master Unit, enabling them to be stored for future use. Ideal for Schools, Educational Authorities and all those interested in radio construction. Parts price list and plans 25p (FREE with parts).

Total building costs
£5-50 P P & Ins. 33p
(Overseas P & P £1-85)
(+ 10% VAT 55p)

RADIO EXCHANGE LTD

★ Callers side entrance "Lavelle" shop.
★ Open 10-1, 2.30-4.30, Mon.-Fri. 9-12 Sat.

To RADIO EXCHANGE CO., 61a HIGH STREET, BEDFORD, MK40 1SA
Tel.: 0234 62367. Reg. No. 788372.

I enclose £..... for

Name

Address

(Dept. PW23.)

NO EXTRAS
ALL PRICES INC. VAT
FREE! P. & P.

AMPLIFIERS

Keltron K8A 700 7+7 watt	23.00
MK II K8A 1500 15+15 watt	32.50
Tripletone MkII Hi-Fi 777+7 watt	27.50
MK II Hi-Fi 1818 18+18 watt	35.00
Telton MKII BAQ3078+8 watt	27.00
EMI 1515 15+15 watt	27.00
Rotel RA210	32.00
RA310	44.00
Rotel Tuner/Amp. RX150A	51.00

RECORD DECKS

Garrard 2025TC/9TAHC/G	11.00
SP25 Mk. III	11.00
BSR MP60/SX5H	11.00
Connoisseur BD1 Kit	11.00
BD2 Chassis	29.50
SAU2 Pick-up Arm	12.25
SCU1 Cartridge	4.95

RECORD DECK PACKAGES

Garrard SP25 Mk. III/8900 C. & P.	19.50
AP76/G800 C. & P.	30.00
Plinth & Cover for Garrard SP25/2025TC	3.95

SPEAKER BARGAINS

EMI 13" x 8" 3, 8 or 15 ohm	
Plain	2.85
with Co-Axial Tweeter	2.50
Twin Tweeter	3.95
Type 350 8 ohm, 20 watt	8.50
6 1/2" 8 ohm, 10 watt	2.85
8" 8 ohm, 10 watt	3.90
12" 8 ohm, 20 watt	6.75
8" x 5" C/Mag. 5 watt	1.40
8" x 5" Dualcone 8 ohm, 10 watt	2.70

PANE 7" x 4" 3 or 8 ohm	1.15
8" Dualcone 8 ohm	2.50
CELESTION 8" 15 ohm	1.75
ADASTRA 10" 8 or 15 ohm, 10 watt	2.95
BAKER GROUP 25	
12" 8 or 15 ohm, 25 watt	6.50
5" 8 ohm, 5 watt C/Mag.	95
2 1/2" 8 ohm or 64 ohm	-80
SELECTION OF GOODMAN AND WHARFEDALE SPEAKERS ALSO AVAILABLE.	
KIT FORM CABINETS-TEAK VENEER	
12 x 12 x 6 with 8", 8" x 5", or 6 1/2" and 3 1/2" cutout	2.75
17 x 10 x 6 with 8" or 13" x 8" cutout	3.50
18 x 11 x 9 with 13" x 8" cut out for EMI 350	4.80
TWEETER & CROSSOVER	
EMI 3 1/2" 3 or 8 ohm C/Mag.	1.10
Cone Tweeter 8 or 15 ohm, 10 watt	2.00
Cone Tweeter 8 ohm, 3 watt	1.10
Horn Tweeter 8 ohm, 20 watt	3.80
Dome Tweeter 8 ohm, 30 watt	4.00
Crossovers CN23 (3 ohm), CN28 (8 ohm), CN216 (16 ohm)	1.10
CARTRIDGES	
ACOS GP91/25C or GP91/35C Stereo comp.	1.05
GP93/1 Stereo crys.	1.35
GP94/1 Stereo crys.	1.75
GP95/1	1.35
GP101	1.75
80NOTONE	75
9TAHC Stereo ceramic, diam.	1.80
9TAHC/G Slim fit, stereo cer. diam.	1.80
19-TT Stereo crystal	85
BSR 805M Stereo ceramic	2.25
SX5S Stereo crystal	1.65
SX5M Stereo crystal	1.65
X5H Mono/stereo	1.30

X5M Mono/stereo	1.30
GOLDRING G800	3.85
G850	2.95
STYLII For Above Cartridges	
Sapphire	30
D. Diamond	1.25
GOLDRING G800 G850	1.95
MICROPHONES	
CM20 Crystal Hand	60
CM70 Planet stick metal, switch crystal	1.70
DM160 Dynamic uni-dir, ball metal	4.00
UD130 50K/600 ohm, uni-dir, ball metal	4.65
TW206	5.90
CONDENSER MIKE 600 ohm, uni-dir.	7.90
Cassette STICK MIKE with R. Control on/off switch (2.5 & 3.5 mm J/Ply)	1.45
MIKE MIXERS Mono	4.10
Mono/stereo de luxe	5.50
CASSETTES	
Type Low Pin-Phil-Mem-Am- noise nacle lips orex pex	
C45	50p
C60	35p 40p 50p 55p 55p
C90	45p 55p 69p 75p 75p
C120	55p 75p 105p 110p
Cassette Head Cleaner	1.45
BIB Stereo Test Cassette	1.65
AMPEX Head Cleaner De-magnetiser	1.85
PLASTIC LIBRARY CASES for 5" Reels 20p, 3 1/2" Reels 25p, 7" Reels 30p.	
CASSETTE CASES	
TAPES Std. L.P. D.T.	
5" 55p 65p 80p	
7" 65p 75p 80p	
AKAI TAPE DECK	75.50
4000DS Tape	64.95
GXC40D Cassette	79.95
CS35 + CS58	79.95

BARCLAYCARD
Buy it with Access

Credit Terms for Callers

BUDGET SYSTEMS
BUSH Stereo System with independent Volume, Bass and Treble controls on each Speaker for optimum reproduction. Using GARRARD 2025TC Auto Change Deck in deluxe teak plinth and cover.
Today's Value £49.50.
OUR PRICE £27.50
+£1.50 p. & p.
12 months Guarantee by Maker. THIS IS A BARGAIN NOT TO BE MISSED!

HEADPHONES	
AMSTRAD HPS5A	4.85
ROTEL	
430	4.90
630	6.20
700	8.95
AKAI	
ASE 115	5.75
ASE 20	7.85
ASE 22	9.25
KOBS	
K711 (Black or Red)	9.95
K6	11.95
K6LC (with Vol. control)	13.25
K0727B	15.75
K0747	19.50
HVI	19.50
PRO4AA	26.95
PRO5LC	28.75
ESP6	42.75
LEESON ELECTROSTATIC	19.50
Mono/stereo super de luxe 8-16Ω	2.75
Headphone Adaptor	2.50
Curly Ex. Lead 20ft.	1.10
IN-CAR ENTERTAINMENT SECTION	
Car Cassette Stereo Player and Two Speakers	20.95
Car 8-track Stereo Player and Two Speakers	16.50
SHIBUYA 8-track Player/Main/Car detachable with 2 separate sets of Speakers	39.95
Pair of Car Stereo Speakers (1Door Mounting)	3.85
Pair of Car Stereo Speakers (1Door Mounting)	3.95

NEWMART ELECTRONICS
ALL MERCHANDISE FULLY GUARANTEED

MAIL ORDER DEPT. (PW/12)
BELMONT STREET MONTON, ECCLES MANCHESTER
Tel. 061-789 5268

CALLERS WELCOME AT OUR BRANCHES
Manchester Liverpool
3623 Shudehill 15 Whitechapel
061-832 7710 051-236 0738
Leeds Sheffield
4 New Market St. 20 Pinstone St.
0532 42708 0742 79308

Stove Enamelled STEEL CABINET



List price £6.87
OUR PRICE £5.50
incl. V.A.T.
Carriage 44p

With 48 see-through Drawers Ideal for the Radio Constructor

As supplied by us to SCHOOLS, TECHNICAL COLLEGES, HOSPITALS, SHOPS and industry throughout the country. Silver grey stove enamelled steel cabinet with 48 transparent styrene drawers fitted with moulded handles and label slots. Dividers can be supplied at a small extra charge to enable each drawer to be sub-divided into six compartments. See-through drawers allow swift selection of contents at a glance. A really first-class time and space saving unit. Size of cabinet 21 1/2" x 11 1/2" x 6 1/2", size of drawers 6 1/2" x 2 1/2" x 1 1/2".

Callers welcome.

SEND FOR FREE ILLUSTRATED LEAFLETS

Trade Aids 111 Chiltern Drive, Surbiton Surrey (100 yards from Berrylands Railway Station) 01-399 4383

TRANSFORMERS
DOUGLAS GUARANTEED
Prices include P. & P. and 10% VAT
12 or 24 Volts

Output V. & Amps.	Ref. No.	Price
12V x 2 250mA x 2	MT11CS*	£1.32
12V x 2 500mA x 2	MT213**	£1.65
12V x 2 1A x 2	MT71CT†	£2.17
12V x 2 2A x 2	MT18CT	£2.63
12V x 2 3A x 2	MT70AT	£3.40
12V x 2 4A x 2	MT108AT	£3.88
12V x 2 5A x 2	MT 72AT	£4.48

30 Volts. All tapped at 0-12-15-20-30V.

Output Ref. No.	Price	Output Ref. No.	Price
Amps.	Amps.	Amps.	Amps.
500mA MT112CT†	£1.43	4A MT21AT	£4.51
1A MT79CT†	£2.22	5A MT51AT	£5.21
2A MT 3AT	£3.22	8A MT88AT	£8.33
3A MT20AT	£3.65	10A MT89AT	£9.66

50 Volts. All tapped at 0-19-25-33-40-50V

Output Ref. No.	Price	Output Ref. No.	Price
500mA MT102AT†	£2.07	3A MT105AT	£5.40
1A MT103AT†	£3.00	4A MT106AT	£6.79
2A MT104AT	£4.01	5A MT107AT	£8.69

60 Volts. All tapped at 0-24-30-40-48-60V.

Output Ref. No.	Price	Output Ref. No.	Price
500mA MT124AT	£2.33	2A MT127AT	£4.36
1A MT126AT	£3.28	3A MT125AT	£6.41

AUTO-WOUND RANGE

Power Output	Winding tapped at	Ref. No.	Price
20VA	0-115-210-240	XMT113CT	£1.25
75VA		XMT64AT	£2.51
150VA	0-115-200-220-240	XMT4AT	£3.06
200VA		XMT85AT	£3.65

400V. Output at 50HZ.

C-D Ignition System by R. M. Marston, Esq., Wireless World Reference IT3AT £3.00

EQUIPMENT RANGE

Sec. Output (r.m.s.)	Ref. No.	Price
3-0-3V 200mA	MT238CS**	£1.41
9-0-9 100mA	MT130CS**	£1.38
12-0-12 50mA	MT239CS**	£1.41
0-20 x 2 30mA	MT241CS**	£1.41
0-8-9 x 2 300mA x 2	MT242CS**	£1.87
0-15-20 x 2 500mA x 2	MT207CT**	£2.22
0-15-27 x 2 500mA x 2	MT205AT**	£2.95
0-15-27 x 2 1A x 2	MT203AT*	£3.38
20-12-0-12-20 700mA (d.c.)	MT204AT*	£3.38
AT indicates open universal fixing with tags; CT is open U-clamp fixing with tags; CS is open U-clamp fixing with P.C. spalls; * with interwinding screen; † tapped 240 primary; ‡ tapped at 210-240V; other primaries tapped at 200-220-240V.	MT221AT*	£1.74

OVER 200 TYPES IN STOCK through Agents or Direct. Please send for lists.

DOUGLAS ELECTRONIC INDUSTRIES LTD.
Direct Sales Dept. P.W., Thame Street, LOUGH, Lincs. LN11 7AD

A DEXTER DIMMASWITCH

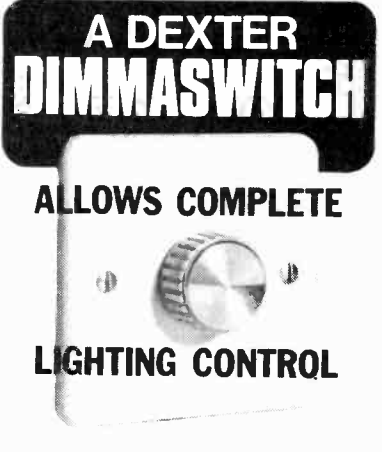

ALLOWS COMPLETE LIGHTING CONTROL

The DEXTER DIMMASWITCH is an attractive Dimmia unit which simply replaces the normal light switch. It is available as a complete 'ready to install' unit or 'simple to assemble' kit. Two models are available controlling up to 300W or 600W of all lights, except fluorescents, at mains 200-250V, 50Hz. All DEXTER DIMMASWITCH models have built-in radio interference suppression.

600 watt £3.52 Kit form £2.97
300 watt £2.97 Kit form £2.42

All plus 12p post and packing
Prices include VAT. Please send c.w.o. to:

DEXTER & COMPANY
15 ULVER HOUSE
9 KING STREET
CHESTER CH1 2AH
Tel: 0244-25883

AS SUPPLIED TO H.M. GOVERNMENT DEPARTMENTS, HOSPITALS, LOCAL AUTHORITIES, ETC.

Exciting...the Stereo 21!

Can you really get sound quality like this FOR LESS THAN £19? YES, YOU CAN! WITH THE NEW

STEREO 21

Until now, richly satisfying sound has always cost a richly satisfying price. *But not any more!* For an almost unbelievable **£18-45**, you can have Stereo 21—audio for the connoisseur! Whatever your taste in music, you can hear it on STEREO 21 the way its composers heard it in their dreams! Beethoven or Mahler . . . Ellington or Jellyroll Morton . . . Das Nibelung or Jesus Christ Superstar . . . Carols from King's College Chapel or the return of a Beatle . . . everything from a prettily fluting baroque organ to the newest pop group at full throttle—STEREO 21 does them all justice!



And have you ever seen a handsomer audio installation? Compact enough to go in a university student's bedroom-study, elegant enough for the suavest penthouse pad in Town, STEREO 21 offers you all the pride of possession as well as a thrilling musical experience!

Top-quality amplifier, BSR turntable, matching speakers. Deck and speaker cabinets you simply wrap round and glue to build. Screw in the amplifier and connect up (all push fit no soldering whatsoever), so simple literally anyone can do it. Except for glue and panel pins all parts supplied including full instructions—all for £18-45 (plus the cost of post and packing if you buy by mail), and—to round it all off—a money refund if not satisfied if your pleasure in STEREO 21 is not complete!

Just think—in only a few days you could be giving your ears the treat of a lifetime—AND introducing your envious friends to STEREO 21!

Power Output 2.7 Watts per channel and headphone socket with automatic cut out provision for auxiliary inputs—radio, tape, etc. and output for taping discs. Overall Dimension:

Speakers approx. 15½" x 8" x 4". Complete deck and cover enclosed position approx. 15½" x 12" x 6".

Personal shoppers and mail order price

£18-45 INCLUDING VAT plus £1-60 p + p.

Diamond stylus, if required, £1-37 extra
Specially selected pair of stereo headphones with individual level controls and padded earpieces to give optimum performance, if required £3-85.

EMI SPEAKERS AT UNBELIEVABLE PRICES

950 Kit. Five matched speakers and crossover unit for handling up to 45 watts, from 20 to 20,000 Hz. Huge—19" x 14" (approx.) high efficiency 16, 500-gauss bass unit built on a heavy diecast frame. The four 10,000 gauss tweeters, each 3¼" dia. approx., are fed by the crossover with a critically adjusted signal for maximum fidelity. Impedance at 1 kHz is 8 ohms. Bass coil 2", others 0-5". Recommended list price £44-00.

OUR PRICE £25-00 + £1-50 p & p

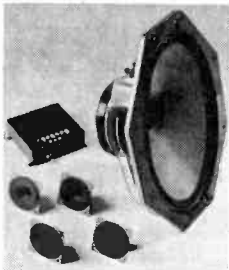

15" 14A/780. Bass unit on a rigid diecast chassis. Superior cone material handles up to 50 watts RMS, and is treated to give a smooth frequency response. Resonance 30 Hz. Fluse 360,000 Maxwells. Impedance at 1 kHz is 8 ohms. 3" voice coil.

Recommended retail price £40-80.

OUR PRICE £18-70 + £1-50 p & p



RADIO AND TV COMPONENTS (ACTON) LTD, 21C HIGH STREET ACTON, LONDON W3 6NG · 323 EDGWARE ROAD, LONDON W2

Edgware: 9 a.m. to 5.30 p.m., half day Thurs.
Acton: 9.30 a.m. to 5 p.m. Closed all day Wed.; also see opposite.
Mail orders to Acton. Terms C.W.O. All enquiries Stamped Addressed Envelope
Goods not despatched outside U.K.

RTVC VISCOUNT III

a boost in the output,

VISCOUNT III now gives you an imposing 20 watts per channel—and the price quoted is actually INCLUSIVE OF VAT!

The money's important, of course, but not nearly so important as value for money! And that's something you get in abundance with VISCOUNT III. We design it... we make it... we sell it direct to you—passing on all the economies that come from cutting out middle-men! That's the only way you can get so much quality for so little money!

The unique VISCOUNT III amplifier, plus the Garrard SP25 Mk III deck, plus the magnificent Duo Type III matched speakers (or Duo Type II for a small room) give you an audio installation that will prove unbeatable for listening pleasure! And the teak finish will harmonise and enhance virtually any style of interior decor! On the brushed aluminium front panel of the amplifier you'll find all the facilities you need—volume, bass, treble and balance controls, plus switches for mono/stereo, on/off function and bass and treble filters. Plus headphone socket on the back.

The heart-stopping timbre of Tom Jones at his most virile... the last lingering harmonics of a solo performance by Heifetz or Menuhin... the pathos and the panache of Liza Minelli... the majestic sonorities of the brass band and the elfin subtleties of the virtuoso clavichordist—hear every nuance with a fidelity that you have never experienced before!

Come and hear VISCOUNT III! If it's inconvenient to travel, buy by post in the confidence that you won't be disappointed (and with a 24-carat Money-Back Guarantee to give you extra reassurance). Don't settle for second-bests!

SPEAKERS: Duo Type II Size approx. 17in x 10½in x 6½in. Drive unit 13in x 8in with parasitic tweeter. Max. power 10 watts 8 ohms. Simulated Teak cabinet. £14.00 a pair + £2.20 p. & p. **Duo Type III** Size approx. 23½in x 11½in x 9½in. Drive unit approx 13½in x 8½in with HF speaker. Max. power 20 watts, 8 ohms. Freq. range 20Hz to 20kHz. Teak veneer cabinet. £32.00 a pair + £3.30 p. & p.

PRICES : SYSTEM I

Viscount III RI02 amplifier £24.20 + £1 p & p
 2 Duo Type II speakers £14.00 + £2.20 p & p
 Garrard SP25 Mk III with MAG cartridge /plinth & cover £18.00 + £1.75 p & p
 total **£56.20**

Available complete for only **£49.00** + £3.50 p & p

PRICES : SYSTEM 2

Viscount RI02 amplifier £24.20 + £1 p & p
 2 Duo Type III speakers £32.00 + £3.30 p & p
 Garrard SP25 Mk III with MAG cartridge plinth & cover £18.00 + £1.75 p & p
 total **£74.20**

Available complete for **£65.00** + £4 p & p

STILL ONLY **£49** COMPLETE



THE TOURIST PUSH-BUTTON CAR RADIO KIT £6.60

The Tourist PB is suitable for 12 volt working on both negative and positive earth vehicles. It covers the full medium and long wave bands. It is permeability tuned and sturdily constructed. Output is a full 2.5 watts into an 8 ohms speaker. But the Tourist PB will operate into any loud-speaker from 8 to 15 ohms. Apart from the output stage, which is an integrated circuit, the only other electronic components that need soldering are some capacitors, resistors, etc. The kit includes a pre-built RF tuner unit, and fully modulated IF stages which are pre-aligned before despatch. As well as electronic components this kit also contains 2 diamond-spun aluminium knobs, elegant matching front panel, dial, washers, screws and wire. The Tourist PB can be mounted in any standard size dash panel and it has an illuminated tuning scale. Chassis size is: 7in wide, 2in high and 4½in deep. Circuit diagram and comprehensive instructions 55p free with parts. Fully retractable and lockable car aerial £1.37 post paid.

CAR RADIO KIT £6.60 p. and p. 55p. Speaker with baffle and fixing strips £1.65, + 23p p. & p. post free if bought with the kit. Send stamped addressed envelope for leaflet. If you can solder on printed circuit board, you can build this push-button car radio kit. It's simple—just follow the step-by-step instructions.

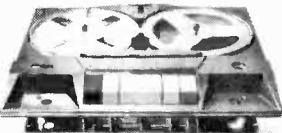

PE TAPE LINK CONSTRUCTORS

Suitable 3 speed tape deck, less heads. Caters up to 5½ins. spools. 240V AC mains. Unused but store soiled hence no warranty. **£4.00** £1 p. & p.

RELIANT Mk IV MONO AMPLIFIER

*5 Electrically Mixed inputs.
 *3 Individual Mixing controls.
 *Separate bass and treble controls common to all 5 inputs.
 *Mixer employing F.E.T. (Field Effect Transistors).
 *Solid Circuity. *Attractive Styling.

State Inputs 1. Crystal Mic or Guitar 9mV. 2. Moving coil Mic. or Guitar 8mV. Inputs 3, 4 & 5 are suitable for a wide range of medium output equipment (Gram, Turner, Monitor, Organ, etc.) All 250mV sensitivity. Output 20 watts into 8 Ω. (suitable for 15 Ω.) Size approx. 12½ x 6 x 3½ ins. **£13.50** p. & p. 60p

UNISOUND MODULES

ONLY **£7.64** + 55p. p & p
 For the man who wants to design his own stereo—here's your chance to start, with Unisound—pre-amp, power amplifier and control panel. No soldering—just simply screw together. 4 watts per channel into 8 ohms. Inputs: 120mV (for ceramic cartridge). The heart of Unisound is high efficiency I.C. monolithic power chips which ensure very low distortion over the audio spectrum.

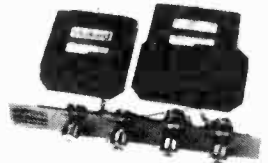

IN-CAR ENTERTAINMENT AT HOME



With this elegant stereo 8 track add on unit, audio enthusiasts now have the opportunity to extend their systems to include the playing of 8 track cartridges. Simply select your channel, by push button, four digital lamps indicate channel selected. The Viscount III, the fabulous Stereo 21 and the Unisound Modules **£10.60** + 90p. p. & p. will accept this unit, simply connect up.

SEE OPPOSITE PAGE FOR ADDRESS DETAILS

BI-PRE-PAK AUDIO BARGAINS

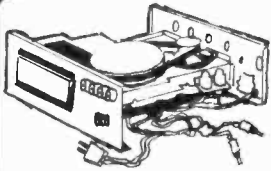

**8 TRACK
ONLY £11**
incl. P. & P. and VAT

The latest **B.S.R. 8 Track** cartridge Replay Deck. Ready to install in your Hi-Fi Stereo System. This unit comes complete with Hi Gain Stereo Pre-Amplifier, 4-Programme Indicator Lamps, Track Selector Switch, all leads and plugs, etc. for 230 volt A.C. mains operation.

5W & 10W AMPS

5W ONLY £1.98
10W ONLY £2.49
incl. P. & P. and V.A.T.



Specification:—	5 Watt	10 Watt
Nominal Volts	12-14V	25-30V
Into 3 Ohms	5W	10W
Into 8 Ohms	2W	10W
Into 15 Ohms	1W	5W
Typical Distortion	-5%	-5%
Freq. response at 3dB	10Hz to 30KHz	10Hz to 30KHz
Sensitivity (Typically)	20mV	20mV
Full power consumption (30 Ohms)	650mA	580mA
Size	2 1/2" x 1 1/2"	2 1/2" x 1 1/2"

The **5W matchbox sized amplifier** will run satisfactorily from a 12V car battery. Can also be used for portable voice reinforcement such as public functions where mains supply is not accessible. A small mains unit kit is available. Two amplifiers are ideal for Stereo. Complete connection details and treble, bass, volume and balance control circuit diagrams are supplied with each unit. Discounts are available for quantity orders.

Cheapest in the U.K. Built and tested

STEREO DECODER
£4.95
incl. P. & P. and VAT

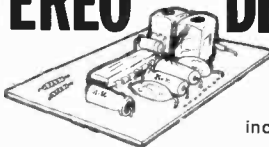

A ready built unit, ready for connection to the I.F. stages of your existing FM Radio or Tuner. A tell tale light can be connected to show the presence of a Stereo transmission and correct operation.

The Unit is in the form of a small printed circuit, and no further alignment is necessary, as all preset adjustments have already been carried out at the factory.

It is recommended that a L.E.D. is used as the indicating light and a suitable device is available from us at 36p. Supplied with all necessary instructions.

I enclose £..... for 8 Tracks/..... 5W
Amps./.....10W Amps./..... Decoders (Please
insert quantities and delete those not applicable.)

Name

Address

BI-PRE-PAK
Co. Regn. No.820919

Dept. D, 222/224, West Road,
Westcliff-on-Sea, Essex SSO 9DF
Tel: Southend (0702) 46344

London's Lighthouse

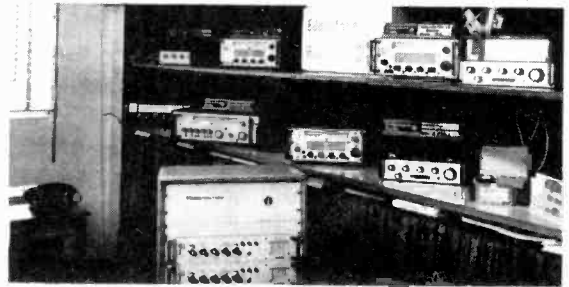

see the



showroom
at

IMHOFS

Here at Imhofs we have a whole showroom entirely devoted to the Eddystone range of communication receivers. From the remarkable little EC10 MkII, the elegance of the Series 1000 range to the sophistication of the 830/7. Pop in and see us - or write for details to:-

112-116 New Oxford Street
London WC1A 1HJ
Telephone 01-636 7878

R83

Quality hi fi Cabinets

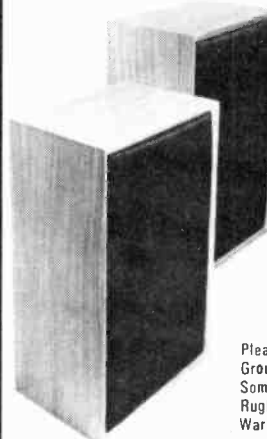

Direct from manufacturer.
Finished in teak or
afrosmosia veneers.

- * Size 17" high x 10" wide x 7" deep.
- * Complete with black Vynair removable front.
- * Routed baffle for 8" bass and 3 1/2" tweeter.
- * Removable baffle board.
- * Lacquered and polished cabinet.
- * Price £9.50 per pair incl. VAT plus 75p packing and carriage.

Please send cash with order direct to
Group 3 Cabinets Ltd.,
Somers Road Industrial Estate,
Rugby,
Warwickshire. Tel: 0788-78211

COMPRESSION TRIMMERS

*** WE STOCK THE LARGEST RANGE IN THE U.K. (Possibly in Europe!)**

Here's a page from our Catalogue showing a few typical types

HOME RADIO (COMPONENTS) LTD. TRIMMER CAPACITORS

Maker: CYLDON

Cat. No.	Maker's No.
VC29D	CBB/30
VC29E	CAA/40
VC29F	CAA/80
VC29H	CAA/180

Size	Capacity	Price
$\frac{3}{4} \times \frac{3}{8} \times \frac{1}{2}$ inches	3-30 pF	10p
	3-40 pF	10p
	10-80 pF	10p
	60-180 pF	12p

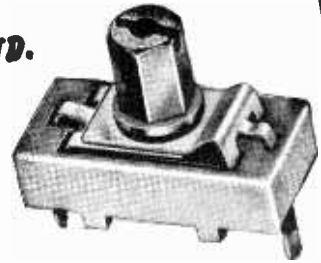

CA-CB types

Cat. No.	Maker's No.
VC29J	MT31A/9
VC29LA	MT31A/3
VC29LC	MT31A/12
VC29K	MT31A/4
VC29LB	MT31A/5
VC29L	MT31A/13

Size	Capacity	Price
$\frac{3}{8} \times \frac{7}{8} \times \frac{3}{8}$ inches	1-5-20 pF	8p
	3-40 pF	8p
	7-60 pF	10p
	10-80 pF	9p
	30-140 pF	10p
	60-180 pF	11p

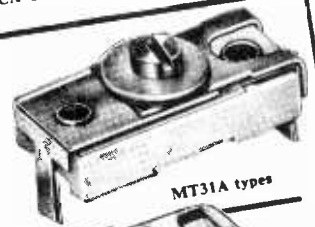

MT31A types

Cat. No.	Maker's No.
VC29M	MT25/18
VC29MA	MT25/1
VC29MB	MT25/2
VC29N	MT25/3
VC29P	MT25/4

Size	Capacity	Price
$\frac{5}{8} \times \frac{7}{8} \times \frac{3}{8}$ inches	1-5-25 pF	11p
	2-5-40 pF	11p
	3-5-70 pF	11p
	20-150 pF	12p
	45-250 pF	12p

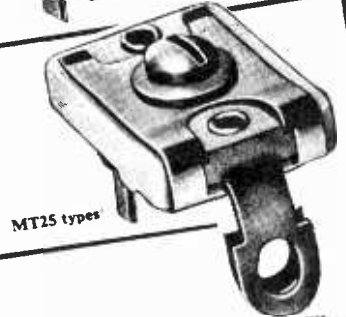

MT25 types

Cat. No.	Maker's No.
VC29PA	TP1
VC29Q	TP4
VC29R	TP12
VC29RB	TP11
VC29S	TP7
VC29SA	TP10
VC29SB	TP29

Size	Capacity	Price
$\frac{5}{8} \times \frac{7}{8} \times \frac{3}{8}$ inches	10-110 pF	12p
	20-250 pF	11p
	50-450 pF	14p
	150-750 pF	17p
	300-1000 pF	18p
	400-1250 pF	19p
	500-2000 pF	22p



TP types

Also a large range of Air Dielectric Trimmers in stock

The Famous Home Radio Components Catalogue lists 6,785 items-1,750 of them illustrated.

* Send now for catalogue

POST THIS COUPON
with cheque or P.O. for 77p.

The price of 77p applies only to catalogues purchased by customers in the U.K. and to BFPO addresses

Please write your Name and Address in block capitals

NAME

ADDRESS

HOME RADIO (Components) LTD.
Dept. PW 234-240 London Road, Mitcham CR4 3HD

Regd. No.
912966
London



ELECTRONIC MAINS TIMER

A reliable unit ideal for timing Bathroom/Toilet Ventilators Stairway/Cloakroom Lighting etc. Gives up to 30 mins delay before switching off. Delay: 1-30 mins adjustable. Max Load: 400VA or 1000 watt resistive. Ivory Case: 3 1/2" x 3 1/2" x 2". Fitting instructions included. Trade Price: £5.80. Post 20p.



DIMMER SWITCH

Type C1. 300 Watt Light Dimmer for 200/250 Volt A/C operation. Ivory Case. 3 1/2" x 3 1/2" x 1 1/2". Fitting instructions included. Price: £2.80. Post 20p.



MAINS KEYNECTOR

The safe, quick, connector for electrical appliances. 13 Amp rating. Fused, will connect a number of appliances quickly and safely to the mains. Ideal for testing, demonstrating. Window displays, etc. Warning Light, interlocked to prevent connecting when live. Trade Price: £2.95. Post 25p.

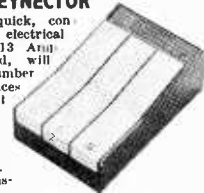

TRANSFORMERS

SAFETY ISOLATING

Prim.- 120/240V. Sec. 120/240V. Centre Tap with screen

VA (watts)	Ref. No.	Price £	P & P £
60	149	2-88	0-38
100	150	3-15	0-52
200	151	5-30	0-52
250	152	7-05	0-65
350	153	9-40	0-80
500	154	13-55	1-00
1000	155	24-97	1-20
2000	158	41-25	*
3000	159	64-54	*

LOW VOLTAGE

Prim.- 200-240V. Sec.- 12 & 24V.

VA	Type	Price £	P & P £
12V 24V	No.	2	
0-5	0-25	111	1-00
1	0-5	213	1-23
2	1	71	1-60
4	2	14	2-25
6	3	70	2-70
8	4	108	3-00
10	5	72	3-55
12	6	118	4-50
16	8	17	5-50
20	10	115	6-95
30	15	187	12-90
40	20	232	18-30
60	30	226	23-70

30 Volts

Prim.- 200-240V. Sec.- 12, 15, 20, 24, 30V.

Amps	Type	Price £	P & P £
0-5	112	1-20	0-22
1	79	1-64	0-38
2	3	2-45	0-38
3	20	3-00	0-42
4	21	3-55	0-52
5	51	4-40	0-52
6	117	5-25	0-52
8	88	6-80	0-87
10	89	8-88	0-87

50 Volts

Prim.- 200-240V. Sec.- 19, 25, 33, 40, 50V.

Amps	Type	Price £	P & P £
0-5	102	1-60	0-30
1	103	2-85	0-38
2	104	3-25	0-42
3	105	4-40	0-52
4	106	5-48	0-52
6	107	8-65	0-87
8	118	11-27	0-97
10	119	14-15	0-97

60 Volts

Prim.- 200-240V. Sec.- 24, 30, 40, 48, 60V.

Amps	Type	Price £	P & P £
0-5	124	1-60	0-38
1	125	2-25	0-38
2	127	3-55	0-42
3	125	5-40	0-52
4	123	6-98	0-67
5	40	8-46	0-87
6	120	9-20	0-87
8	121	11-60	1-00
10	122	15-25	1-00
12	189	18-48	1-10

MINIATURE AND EQUIPMENT

Prim 240V with screen

Volts		Milliamps		Type No.	Price £	P & P £
Sec. 1	Sec. 2	Sec. 1	Sec. 2			
3-0-3	---	200	238	1	1-12	0-10
0-6	0-6	500	500	234	1-18	0-10
0-6	0-6	1000	1000	212	1-28	0-22
0-0-9	---	---	---	13	0-85	0-10
0-9	0-9	330	330	235	1-28	0-10
0-8-9	0-8-9	500	500	207	1-70	0-22
0-8-9	0-8-9	1000	1000	208	2-30	0-30
15-0-15	---	40	---	240	1-28	0-10
0-15	0-15	200	200	238	1-28	0-10
20-0-20	---	30	---	241	1-09	0-10
0-20	0-20	150	150	257	1-28	0-10
0-15-20	0-15-20	500	500	205	2-18	0-38
0-20	0-20	300	300	214	1-86	0-22
20-12-0-12-20	---	700(D/C)	---	221	1-81	0-30
0-15-20	0-15-20	1000	1000	206	3-10	0-38
0-15-27	0-15-27	500	500	203	2-88	0-38
0-15-27	0-15-27	1000	1000	204	3-40	0-38

PLASTIC CASED SILICON BRIDGE RECTIFIERS

One Amp	Two Amp	Four Amp	Six Amp
50 Volt 25p	50 Volt 85p	100 Volt 55p	50 Volt 65p
100 Volt 25p	100 Volt 40p	200 Volt 59p	100 Volt 70p
200 Volt 25p	200 Volt 45p	400 Volt 65p	200 Volt 80p
600 Volt 30p	600 Volt 50p	600 Volt 75p	400 Volt 80p
1000 Volt 55p	800 Volt £1.00	600 Volt £1.00	



PLEASE ADD 10% FOR V.A.T.

ADD 10p P & P PER ORDER

A.S.P. LTD.

BYRE HOUSE · No. 2 UNIT · SIMMONDS RD · WINCHEAP CANTERBURY · KENT · CT1 3RW Canterbury (0227) 52436

D.I.Y. ELECTRONIC ORGAN KITS

In use throughout the world by professionals



★Portable—4 octave keyboard with 10 voices, 3 pitches—vibrato, £145.29. ★ Console—5 octave keyboard with 10 voices, 3 pitches. Keyboard can be split into solo and accompaniment. Vibrato, built in amplifier and speaker £250.93. ★ Console—2 x 4 octave keyboards and 13 note pedal board, 29 voices. Vibrato, Delay Vibrato, Sustain, Reverberation, Percussion, Wah Wah, £406.00. ★ Console—2 x 5 octave keyboards and 32 note pedal board, 32 voices. Vibrato, Delay Vibrato, Sustain, Reverberation, Percussion, 3 Couplers, etc., at £572.55.

V.A.T. please add 10%—show separately on order.

All components can be bought separately. Send 50p for 24-page catalogue which includes details of specialised components plus free vouchers worth 50p.

Also available—WIRELESS WORLD SOUND SYNTHESIZER KITS complete with reprinted instructions.

ELVINS ELECTRONIC MUSICAL INSTRUMENTS

12 Brett Road, Hackney, London, E.8. Tel: 01 986 8455
8 Puddle Bridge Rd., London, SW18 1HU. Tel: 01 870 4949

PLUGS & LEADS

Pack 107 5 pin Din	22p
Pack 108 3 pin Din	20p
Pack 135 1/2" Jack	27p
Pack 130 1/2" Jack Stereo	50p
Pack 103 Loudspeaker Plug	17p
Pack 100 Phono Plug	7p
Pack 230 3 pin Socket	25p
Pack 236 5 pin Socket	33p
Pack 234 Loudspeaker Socket	33p

Ready-made Leads

3 pin to 3 pin Din	70p
3 pin to open end	55p
5 pin to 5 pin Din	90p
5 pin to open end	70p
5 pin to 4 phono plugs	£1.00
Speaker lead Din to spade 12ft	40p
Extension lead Din plug to socket 12ft.	70p

All leads approx. 6ft. in length

DIAMOND STYLUS

8TA; 9TA; 9TAHC; GP91; ST4; ST9; EV26; GC8.All at 80p each.

Double Diamond £1.25
Diamond suitable for Orbit NM22; G800; M3D £2.25 each

CARTRIDGES

Goldring G800	£6.00
Orbit NM22	£4.00
Shure 75/6	£6.00
Sonotone 9TAHC (Dia)	£2.00
Sonotone 8T4A (Dia)	£1.50
Ronnette 105 (Dia)	£1.25

All prices include VAT and postage

RECORD CARE

Cecil Watts Dust Bug	£1.20
Parastatic Disc Preener	45p
Antistatic Fluid	20p
Dust Bug Spares (Brush & Roller)	15p

CASSETTE TAPES

Audio-Magnetic C60	
Qty 3 6 10 20	
Price £1.00 £1.90 £3.20 £6.30	
Cassette Caddy £1.20	
Cassette Head Cleaner 35p	

ZONALILFORD TAPE

5" Standard 600ft	25p
5 1/2" Standard 900ft	50p
7" (Plain boxed) 1200ft	60p
7" (Westminster Boxed) 1800ft	£1.25
7" Reel of Leader Tape (Blue or green)	75p

HEADPHONES

Sennheiser HD414	£10.60
AKG K50	£6.50
Beier DT485	£35.00

MICROPHONES

AKG D109	£11.50
AKG D202E1	£39.50
AKG D190C	£17.00
AKG D190E	£18.20
AKG D224	£50.00
Sennheiser MD211N	£45.00
Sennheiser MD413N	£27.00
Sony ECM50	£85.00
Audio RM57F Radio Mike	£210.00

SPEAKERS

E.M.I. 350 Kit Bohms	£8.20
E.M.I. 450 Kit Bohms	£4.50

J. J. Francis (Wood Green) Ltd
MANWOOD HOUSE, MATCHING GREEN, HARLOW, ESSEX CM17 0RS Telephone: Matching 476

YES, "YOU'VE GOT THE WHOLE WIDE WORLD IN YOUR HANDS!" ALMOST UNBELIEVABLE! Think of the year 1984 and what might be produced then—now get the fantastic ASTRAD 17 and SEE for yourself that the incredible Russians have done it all NOW! It's the radio perfectionist's dream come true! THIS ONE SUPERSEDES ALL EARLIER MODELS! It will probably make your present radio seem like a "crystal set"! Complete with optional battery eliminator for both battery and mains use! We're almost giving them away at only £18.50—a mere fraction of even today's Russian miracle price! We challenge you to compare performance and value with £80 radios! ★ Send quickly, from receipt of goods test on mail order 7 days approval, refund if not delighted. Or call. Volume controlled from a whisper to a roar that would fill a hall! Much wider band spread, for absolute "laser-pointing" station selection! Plus "MAGIC EYE" tuning level indicator for ultra perfect tuning sensitivity! Yes, the Russians have surpassed themselves, proving again their fantastic ability in the field of electronics and brilliantly reflecting their advanced micro-circuitry techniques in the field of spaceship and satellite communications. Yes, EVERY WAVEBAND instantly at your fingertips including Standard Long, Medium, Short and Ultra Short Waves to cover the four corners of the earth during 24 hours a day including all normal transmissions, VHF, FM/USW, AM/LW, MW, SW, gets, locally, local & new stations, not yet operational, and messages from all over the world! Expensive TURRET TUNER side control waveband selection unit (as used on expensive T.V.'s). Every waveband clicks into position giving incredible ease of station tuning! Genuine push-pull Super ON/OFF volume and separate Treble and Bass tone controls for utter perfection of reproduction and tone! Press-button dial illumination! Take it anywhere—runs economically on standard batteries (obtainable everywhere) or direct through battery eliminator from 220/240V AC mains supply. Internal ferrite rod aerial plus built-in "rotatable" telescopic aerial extending to 39 in approx. It's also a fabulous CAR RADIO. Can also be used through extension amplifier, tape recorder or public address system. SIZE 13in x 10in x 4 1/2in overall approx. Magnificently designed, in highly polished cases. Made to give years of perfect service. Purer & sweeter tone than ever. (U.K. service facilities & spares available for years & years to come, if ever necessary!). With WRITTEN GUARANTEE, manual with simple operating instructions & circuit diagram. PLUS ultra sensitive earphone for personal listening, ONLY £18.50 (with mains/battery eliminator £2.25 extra) BOX, POST, ETC. 45p. NO MORE TO PAY! ★ BUT WAIT, for only 75p extra you get the sensational "COMPUTERISED" WORLD TUNING GUIDE (it enables you to zone & time in a flash for transmissions the whole world over—even a child can do it in a flash—it even lets you know when to tune into the U.K. when abroad. NO GUESSING! NO MESSING!) PLUS Standard "longlife" batteries and Converter Plug. (Sorry—We cannot change these new radios for any earlier model purchased.) Send quickly to Uxbridge Road address, or call at either Store. But HURRY! SHOPERTUNITIES SAVE YOU £££'s and £££'s.

THOUSANDS of MILES REDUCED to INCHES? 1973 RUSSIAN RADIO TECHNOLOGY SHRINKS THE WORLD! *COMPUTERISED?



BRAND NEW
FABULOUS **ASTRAD 17**
PORTABLE RADIO & COMMUNICATIONS
RECEIVER



28 TRANSISTORS
AND DIODES!
WAVEBANDS:
STANDARD LONG and MEDIUM
Plus 5 SHORT WAVEBANDS
Plus ULTRA SHORT WAVES
(V.H.F. AM, FM, MW,
LW, USW.)

*MUST
YOU PAY UP
TO £80?

FIRST TIME EVER!
★ NOW AVAILABLE WITH
fabulous **COMPUTERISED**
WORLD TUNING GUIDE!
NO MORE GUESSWORK—
INSTANT DATA at your finger tips —
enables you to ZONE & TIME IN A FLASH
for transmissions the world over!

THIS
OFFER
ONLY
FROM
US!

BATTERY
MODEL **£18.50** BOX
POST
ETC. 45p
MAINS/BATTERY
ELIMINATOR £2.25 extra

BUY ONE FROM US! **SAVE £23.03 NOW!**
Fabulous BRAND NEW **SOLID STATE** This equipment's got EVERYTHING!

BATTERY/MAINS AC
Combined
V.H.F. AM/FM
RADIO and
CASSETTE
TAPE RECORDER
& PLAYER

RECOMMENDED
RETAIL PRICE £44

OUR PRICE **£20.97** CARR
ETC. 50p

WITH REMOTE
CONTROL MICROPHONE

Shopertunities "thunder" ahead with an offer that's FANTASTIC (even by our standards!). We've snapped up 500 magnificent machines. Latest semi-conductor in the world of sound! First-class makers! Fabulous VHF, AM/FM Radio AND Cassette Tape Recorder & Player combined & it also runs on standard batteries or mains. (Simply plug in the 220/240V AC line cord.) Record and play back anything, anywhere! IMPORTERS RECOMMENDED RETAIL PRICE £44! WE OFFER AT UNDER HALF PRICE! Wonderful features: ★ Press-button Keyboard Control Panel or latest MASTER SWITCH CONTROL ★ "MAGIC EYE" Visual Battery check/recording level indicator or built-in automatic Leveller! ★ Separate ON/OFF and HI-LO volume controls! ★ Heavy duty built-in speaker! ★ Earphone (for personal listening or "monitoring") and extension speaker sockets! ★ Remote control microphone! ★ Built-in swivel telescopic extension aerial (24in approx.)! Magnificently made case with carry handle. (DESIGNS VARY SLIGHTLY.) Takes standard 30, 60, 90 or 120-minute Cassette Tapes, obtainable everywhere. AND the amazing built-in full circuit VHF, AM/FM Radio gives you superb clarity of tone, incredible station selection. Unique rotating Station Selector Dial—gets, locally, local city and regional stations in every part of the country, plus B.B.C., National, VHF. Picks up dozens of foreign stations. Fabulous in your car! You could pay £££'s more for a Car Radio or Car Cassette player ALONE! £20.97, carry, etc., 50p—NO MORE TO PAY! Complete with simple instructions, remote control microphone with on/off switch and microphone stand. WITH WRITTEN GUARANTEE. Send quickly, test on mail order 7 day approval from receipt of goods, refund if not delighted. Or call. **BONUS OFFER:** Batteries and Cassette Tape 28p extra if required. Callers: ACCESS & BARCLAY CARDS ACCEPTED AT BOTH STORES.

FIRST TIME EVER! *SAVE £16.02!
BRAND NEW AC/DC BATTERY/MAINS

Cassette
TAPE
RECORDER
& PLAYER

With remote
control
microphone.

FIRST
CLASS
MAKERS

WE COULD
CHARGE UP TO
£26.97!

OUR PRICE **£10.95**
POST ETC.
50p

THE ONE STEP FORWARD EVERYONE HAS WAITED FOR! NOW a superb de luxe portable BATTERY/MAINS tape recorder and player—and incredible Shopertunities bring it to you for ONLY £10.95. Due to our cut price we cannot name first-class makers—but rest assured you're getting one of the BEST! Expensive "PIANO KEYBOARD" CONTROL PANEL (or latest MASTER SWITCH control) AND AUTOMATIC LEVEL CONTROL. No fiddling with awkward tape and reels, just "slap-in" a cassette and off you go! (Takes 30, 60 or 90 minute standard cassette tapes obtainable everywhere.) Amazing performance ensures perfect tapings and superb reproduction! Remote control microphone. Rapid Rewind! Fast forward! Beautiful tone from a whisper to a roar! Complete—record anywhere, indoors or out! Runs on standard batteries AND 220/240V AC mains. Separate jacks for remote control microphone, etc. Size 9 1/2in x 5in x 2 1/2in approx. Design can vary slightly. With carry handle. WRITTEN GUARANTEE and full instructions. (Importers recommended selling price £26.97!) OUR PRICE ONLY £10.95, post, etc. 50p. NO MORE TO PAY! ★ Send quickly, test on mail order 7 days approval from receipt of goods—refund if not delighted. BONUS OFFER—Cassette tape, Standard batteries AND microphone stand 55p extra, if required.

Order by post to Uxbridge Road address or call at either store. Bargains galore at both stores. (COMMERCIAL TRAVELLERS PLEASE NOTE: Merchandising office at Holborn Store.)

Dept. W/P/N/C/35, 164 UXBRIDGE RD., (facing Shepherds Bush Green), LONDON W12 8AQ. (Thurs. 1, Fri. 7). Also at 37/39 HIGH HOLBORN (opposite Chancery Lane), LONDON, W.C.1. (Thurs. 7 p.m.). BOTH OPEN MON. TO SAT. 9 A.M. TILL 6 P.M.

SHOPERTUNITIES LTD.

The largest selection

EX COMPUTER BOARDS

Packed with transistors, diodes, capacitors and resistors—COMPONENT VALUE £1.50, 3 for ONLY 55p + p & p 30p

SPECIAL ONE. As above PLUS Power Transistors ONLY 65p each + p & p 15p

STABILISED POWER MODULES
Complete with circuit diagrams, etc. 99p each + p & p 15p

PAXOLINE BOARDS 71 9" approx. 4 for 80p + p & p 20p.

FIBRE-GLASS PRINTED CIRCUIT BOARDS

164 x 4" approx. 2 for 65p

DECON-DALO 33PC Marker

Etch resistant printed circuit marker pen 90p each

VEROBOARDS

Packs containing approx. 50sq. ins. various sizes, all 1-matrix 65p

REPAKON CHOKES & COILS

RF Chokes
CH1. 2.5mH 25p CH2. 5.0mH 25p
CH3. 7.5mH 25p CH4. 10mH 25p
CH5. 1.5mH 25p

COILS
DRX1 Crystal set 66p DRR2 Dual range 45p

COIL FORMERS & CORES

NORMAN 1" Cores & Formers 7p
1" Cores & Formers 8p

SWITCHES

DP/DT Toggle 25p SP/RT Toggle 18p

FUSES

1 1/2" and 20mm. 100mA, 200mA, 250mA, 500mA, 1A, 1.5A, 2A
QUICK-BLOW 4p ea. ANTI-SURGE 5p ea.

EARPHONES

Crystal 2.5mm plug 33p
Crystal 3.5mm plug 33p
4 ohms 2.5mm plug 22p
8 ohms 3.5mm plug 22p

DYNAMIC MICROPHONES

H1223. 300 ohms plus on/off switch and 2.5mm and 3.5mm plugs £1.60

3-WAY STEREO HEADPHONE JUNCTION BOX

H1012 £1.87

2-WAY CROSSOVER NETWORK

K4007. 80 ohms Imp. Insertion loss 3dB £1.21

CAR STEREO SPEAKERS

(Angled) £3.85 per pair.

BI-PAK

CATALOGUE AND LISTS
Send S.A.E. and 10p.

INSTRUMENT CASES



(Black Vinyl covered)

No.	Length	Width	Height	Price
BV1	8"	5 1/2"	2"	90p
BV2	11"	6"	3"	£1.20

ALUMINIUM BOXES

BA1	5 1/2"	2 1/2"	1 1/2"	42p
BA2	4"	4"	1 1/2"	41p
BA3	4"	2 1/2"	1 1/2"	41p
BA4	5 1/2"	4"	1 1/2"	47p
BA5	4"	2 1/2"	2"	41p
BA6	3"	2"	1 1/2"	34p
BA7	7"	5"	2 1/2"	66p
BA8	8"	6"	3"	84p
BA9	6"	4"	2"	64p

VISIT OUR COMPONENT SHOP

18 BALDOCK ST., WARE, Herts. (A10)

Open Mon.-Thurs. 9.15-6 p.m. Sat. 9.15-5.30 Late Night Shopping until 7 Fri. Tel. 61593

BIB HI-FI ACCESSORIES

De Luxe Groov-Kleen

Model 42 £1.84

Chrome Finish Model 60 £1.50

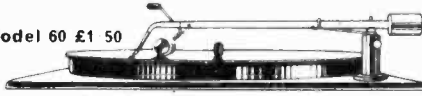

Ref. 36A. Record/Stylus Cleaning Kit 82p
Ref. 43. Record Care Kit £2.85
Ref. 31. Cassette Head Cleaner 54p
Ref. 32. Tape editing Kit £1.54
Model 9. Wire Stripper/Cutter 83p

Ref. P. Hi-Fi Cleaner 31p
Ref. 32A. Stylus Balance £1.86
Ref. J. Tape Head Cleaning Kit 51p
Ref. 34. Cassette Case £1.27
Ref. 56. Hi-Fi Stereo Hints & Tips 82p

ANTEX SOLDERING IRONS

X25. 25 watt £1.93
CCN 240. 15 watt £2.15
Model G. 18 watt £2.15
SK2. Soldering Kit £2.86
STANDS: ST1 £1.21. ST2 77p
SOLDER: 188WG Multicore 7oz 82p
228WG 7oz 82p. 188WG 22ft 82p
228WG Tube 22p

ANTEX BITS and ELEMENTS

Bits No.
102 For model CCN240 3/32" 38p
104 For model CCN240 3/16" 38p
100 For model CCN240 3/32" 38p
101 For model CCN240 3/8" 38p
1102 For model CCN240 1" 38p
1020 For model G240 3/32" 38p
1021 For model G240 1/8" 38p
1022 For model G240 3/16" 38p
50 For model X25 3/32" 38p
51 For model X25 1/8" 38p
52 For model X25 3/16" 38p

ELEMENTS
ECN 240 £1.16 ECEN 240 £1.32
EG 240 £1.16 EX 25 £1.16

ANTEX HEAT SINKS 10p

V.A.T. Included in all prices. Please add 10p P. & P. (U.K. only). Overseas orders—please add extra for postage.

NEW COMPONENT PAK BARGAINS

Pack No.	Qty.	Description	Price
C1	250	Resistors mixed values approx. count by weight	0.55
C2	200	Capacitors mixed values approx. count by weight	0.55
C3	50	Precision Resistors mixed values	1%. 2% 0.55
C4	75	1/4W Resistors mixed preferred values	0.55
C5	5	Pieces assorted Ferrite Rods	0.55
C6	2	Tuning (gangs, MW/LW VHF)	0.55
C7	1	Pack Wire 60 metres assorted colours	0.55
C 8	10	Reed Switches	0.55
C 9	3	Micro Switches	0.55
C10	15	Assorted Pots & Pre-Sets	0.55
C11	5	Jack Sockets 3 x 3.5m 2 Standard Switch Type	0.55
C12	40	Paper Condensers preferred types mixed values	0.55
C13	20	Electrolytic Trans. types	0.55
C14	1	Pack assorted Hardware—Nuts/Bolts, Grommets etc.	0.55
C15	4	Mains Slide Switches	0.55
C16	20	Assorted Tag strips & Panels	0.55
C17	10	Assorted Control Knobs	0.55
C18	4	Rotary Wave Change Switches	0.55
C19	3	Relays 6-24V Operating	0.55
C20	4	Sheets Copper Laminate approx. 10" x 7"	0.55

PLUGS AND SOCKETS

SOCKETS
PB 35 DIN 2 Pin (Speaker) 0-06
PB 36 DIN 3 Pin 0-10
PB 37 DIN 5 Pin 180° 0-10
PB 38 DIN 5 Pin 240° 0-10
PB 39 Jack 2.5mm Switched 0-09
PB 40 Jack 3.5mm Switched 0-10
PB 41 Jack 1" Switched 0-17
PB 42 Jack Stereo Switched 0-26
PB 43 Phono Single 0-06
PB 44 Phono Double 0-10
PB 45 Car Aerial 0-09
PB 46 Co-Axial Surface 0-09
PB 47 Co-Axial Flush 0-14

INLINE SOCKETS

PB 21 D.I.N. 2 Pin (Speaker) 0-13
PB 22 D.I.N. 3 Pin 0-17
PB 23 D.I.N. 5 Pin 180° 0-17
PB 24 D.I.N. 5 Pin 240° 0-17
PB 25 Jack 2.5mm Plastic 0-10
PB 26 Jack 3.5mm Plastic 0-12
PB 27 Jack 1" Plastic 0-24
PB 28 Jack 1" Screened 0-28
PB 29 Jack Stereo Plastic 0-28
PB 30 Jack Stereo Screened 0-32
PB 31 Phono Screened 0-14
PB 32 Car Aerial 0-15
PB 33 Co-Axial 0-17

PLUGS

PB 1 D.I.N. 2 Pin (Speaker) 0-11
PB 2 D.I.N. 3 Pin 0-12
PB 3 D.I.N. 4 Pin 0-15
PB 4 D.I.N. 5 Pin 180° 0-14
PB 5 D.I.N. 5 Pin 240° 0-15
PB 6 D.I.N. 6 Pin 0-18
PB 7 S.I.N. 7 Pin 0-18
PB 8 Jack 2.5mm Screened 0-10
PB 9 Jack 3.5mm Plastic 0-09
PB 10 Jack 3.5mm Screened 0-12
PB 11 Jack 1" Plastic 0-13
PB 12 Jack 1" Screened 0-18
PB 13 Jack Stereo Screened 0-29
PB 14 Phono 0-06
PB 15 Car Aerial 0-15
PB 16 Co-Axial 0-10

CABLES

CP 1 Single Lapped Screen 0-08
CP 2 Twin Common Screen 0-08
CP 3 Stereo Screened 0-08
CP 4 Four Core Common Screen 0-23
CP 5 Four Core Individually Screened 0-30
CP 6 Microphone Fully Braided Cable 0-10
CP 7 Three Core Mains Cable 0-07
CP 8 Twin Oval Mains Cable 0-06
CP 9 Speaker Cable 0-04
CP 10 Low Loss Co-Axial 0-10

CARBON POTENTIOMETERS

Log and Lin
4.7K, 10K, 22K, 47K, 100K, 220K, 470K, 1M, 2M
VC 1 Single Less Switch 0-14
VC 2 Single D.P. Switch 0-26
VC 3 Tandem Less Switch 0-44
VC 4 1K Lin Less Switch 0-14
VC 5 100K Log anti-Log 0-44

HORIZONTAL CARBON PRESETS

0-1 watt 0-06 each
100, 220, 470, 1K, 2.2K, 4.7K, 10K, 22K, 47K, 100K, 220K, 470K, 1M, 2M, 4.7M

BOOK BARGAIN BUNDLE

8 Books comprising
2 Transistor Equivalent Books
1 Radio and Electronic Colour Code and Data Chart
1 Radio Valve Guide PLUS
3 other Constructional books on Receivers, FM Tuners, etc.
Also 1 General Constructional book
Value £3 Our Price £2 10p p & p

BP1 Handbook of Transistor Equivalents and Substitutes 40p
BP2 Handbook of Radio, T.V. and Industrial Tube & Valve Equip. 40p
BP3 Handbook of Tested Transistor Circuits 40p
BP4 International Handbook of the Worlds Short Wave, Medium and Long Wave Radio Stations and FM/TV Listings 85p
BP5 Handbook of Simple Transistor Circuits 85p
BP7 Radio & Electronic Colour Codes and Data Chart 15p
BP8 Sound and Loudspeaker Manual 50p
BP9 38 Practical Tested Diode Circuits for the Home Constructor 85p
BP11 Practical Transistor Novelty Circuits 40p
129 Universal Gram-Motor Speed Indicator 8p
138 How to make FM & TV Aerials, Bands 1, 2 and 3 18p
141 Radio Servicing for Amateurs 20p
146 High Fidelity Loudspeaker Enclosures 87p
156 Transistor Circuits Manual No. 1 15p
160 Coil Design & Constructional Manual 80p
161 Radio, TV and Electronics Data Book 25p
170 Transistor Circuits for Radio Controlled Models 40p
174 Transistor Subminiature Receivers 32p
175 Transistor Test Equipment and Servicing Manual 25p
176 Transistor Audio Amplifier Manual 40p
177 Modern Transistor Circuits for Beginners 40p
178 A Comprehensive Radio Valve Guide, Book 5 30p
183 How to Receive Foreign TV Programmes on your set by simple modifications 82p
186 Tested Shortwave Receiver Circuits using MAT's 80p
187 The TSL Mark '4' Valved FM Tuner and its construction 20p
196 Reactance-Frequency Chart for Audio & RF use 15p
Resistor Colour Code Disc Calculator 10p

CARTRIDGES

ACOS GP91-18C. 200mV at 1.2cm/sec £1.16
ACOS GP93-1. 280mV at 1cm/sec £1.65
ACOS GP96-1. 100mV at 1cm/sec £2.65
TTC J-2005. Crystal/HI Output 95p
TTC J-20 10C Crystal/HI Output Compatible £1.10
TTC J-200 CS Stereo/HI Output £1.60
TTC J-2105 Ceramis/Mel. Output £1.64

CARBON FILM RESISTORS

The E12 Range of Carbon Film Resistors. 1/8th watt available in PAKS of 50 pieces, assorted into the following groups:—
R1 50 Mixed 100 ohms-820 ohms 40p
R2 50 Mixed 1K ohms-8.2K ohms 40p
R3 50 Mixed 10K ohms-82K ohms 40p
R4 50 Mixed 100K ohms-1 Meg. ohms 40p
THESE ARE UNBEATABLE PRICES—LESS THAN 1p EACH INCL. V.A.T.

BI-PAK SUPERIOR QUALITY LOW - NOISE CASSETTES

C60. 32p C90. 41p C120. 62p

-the lowest prices!

BI-PAK QUALITY COMES TO AUDIO!

AL10/AL20/AL30 AUDIO AMPLIFIER MODULES

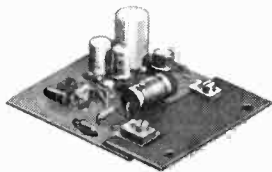

The AL10, AL20 and AL30 units are similar in their appearance and in their general specification. However, careful selection of the plastic power devices has resulted in a range of output powers from 3 to 10 watts R.M.S.
The versatility of their design makes them ideal for use in record players, tape recorders, stereo amplifiers and cassette and cartridge tape players in the car and at home.

Parameter	Conditions	Performance
HARMONIC DISTORTION	Po = 3 WATTS f=1KHz	0.25%
LOAD IMPEDANCE	—	8-16 Ω
INPUT IMPEDANCE	f=1KHz	100 k Ω
FREQUENCY RESPONSE @ 3dB	Po=2 WATTS	50 Hz - 25KHz
SENSITIVITY FOR RATED O/P	Vs=25V. Rl=8 Ω f=1KHz	75mV. RMS
DIMENSIONS	—	3" x 2 1/4" x 1"

The above table relates to the AL10, AL20 and AL30 modules. The following table outlines the differences in their working conditions.

Parameter	AL10	AL20	AL30
Maximum Supply Voltage	25	30	30
Power output for 2% T.H.D. (RL = 8 Ω f = 1 KHz)	3 watts RMS Min.	5 watts RMS Min.	10 watts RMS Min.

AUDIO AMPLIFIER MODULES

AL 10. 3 watts RMS	£2.19
AL 20. 5 watts RMS	£2.59
AL 30. 10 watts RMS	£3.01

POWER SUPPLIES

PS 12. (Use with AL10 & AL20)	85p
SPM 80. (Use with also AL30 & AL50)	£3.25

FRONT PANELS SP 12 with Knobs £1.10

PRE-AMPLIFIERS

PA 12. (Use with AL10 & AL20)	£4.35
PA 100. (Use with AL30 & AL50)	£13.15

TRANSFORMERS

T461 (Use with AL10)	£1.39 P & P 15p
T538 (Use with AL20)	£1.93 P & P 15p
BMT80 (Use with AL30 & AL50)	£2.15 P & P 25p

PA 12. PRE-AMPLIFIER SPECIFICATION

The PA 12 pre-amplifier has been designed to match into most budget stereo systems. It is compatible with the AL 10, AL 20 and AL 30 audio power amplifiers and it can be supplied from their associated power supplies. There are two stereo inputs, one has been designed for use with *Ceramic cartridges while the auxiliary input will suit most †Magnetic cartridges. Full details are given in the specification table. The four controls are, from left to right: Volume and on/off switch, balance, bass and treble. Size 152mm x 84mm x 35mm.

Frequency response—
20Hz - 50KHz (-3dB)
Bass control—
± 12dB at 60Hz
Treble control—
± 14dB at 14KHz
*Input 1. Impedance
1 Meg. ohm
Sensitivity 300mV
†Input 2. Impedance
30 K ohms
Sensitivity 4mV

EA1000 AUDIO AMP MODULE 3 WATTS R.M.S.

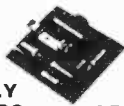

Module Tested and Guaranteed. Full book-up diagrams and complete technical data supplied free with each module or available separately at 10p each.

ONLY
£2.89

SPECIAL OFFER £2 each while stores last

The STEREO 20

The 'Stereo 20' amplifier is mounted, ready wired and tested on a one-piece chassis measuring 20 cm x 14 cm x 5.5 cm. This compact unit comes complete with on/off switch volume control, balance, bass and treble controls, Transformer, Power supply and Power amps. Attractively printed front panel and matching control knobs. The 'Stereo 20' has been designed to fit into most turntable plinths without interfering with the mechanism or, alternatively, into a separate cabinet. Output power 20w peak. Input 1 (Cer.) 300mV into 1M. Freq. res. 25Hz-25kHz. Input 2 (Aux.) 4mV into 30K. Harmonic distortion. Bass control ±12dB at 60Hz typically 0.25% at 1 watt. Treble con. ±14dB at 14kHz.

£13.48

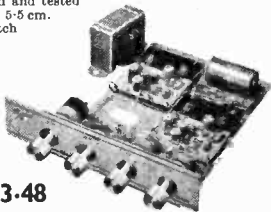

50W pk 25w (RMS)

0.1% DISTORTION!
HI-FI AUDIO AMPLIFIER

THE AL50

★ Frequency Response 15Hz to 100,000-1dB.

★ Load—3, 4, 8 or 16 ohms.

★ Distortion—better than .1% at 1 KHz.

★ Signal to noise ratio 80dB.

ONLY
£3.58 each

★ Supply voltage 10-35 Volts.

★ Overall size 63mm 105mm x 13mm.

Tailor made to the most stringent specifications using top quality components and incorporating the latest solid state circuitry and ALSO was conceived to fill the need for all your A.F. amplification needs.
FULLY BUILT—TESTED—GUARANTEED.

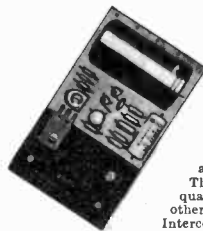
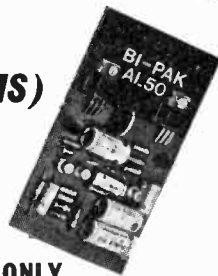

STABILISED POWER MODULE SPM80

AP80 is especially designed to power 2 of the AL50 Amplifiers, up to 15 watt (r.m.s.) per channel simultaneously. This module embodies the latest components and circuit techniques incorporating complete short circuit protection. With the addition of the Mains Transformer MT80, the unit will provide outputs of up to 1.5 amps at 35 volts. Size: 63mm x 105mm x 30mm.
These units enable you to build Audio Systems of the highest quality at a hitherto unobtainable price. Also ideal for many other applications including—Disc Systems, Public Address Intercom Units, etc. Handbook available 10p PRICE £3.25

TRANSFORMER BMT80 £2.15 p. & p. 28p

STEREO PRE-AMPLIFIER TYPE PA100

Built to a specification and NOT a price, and yet still the greatest value on the market. The PA100 stereo pre-amplifier has been conceived from the latest circuit techniques. Designed for use with the AL50 power amplifier system, this quality made unit incorporates no less than eight silicon planar transistors, two of these are specially selected low noise NPN devices for use in the input stages.
Three switched stereo inputs, and rumble and scratch filters are features of the PA100, which also has a STEREO/MONO switch, volume, balance and continuously variable bass and treble controls.

SPECIFICATION

Frequency Response	20Hz - 20KHz ± 1dB
Harmonic Distortion	better than 0.1%
Inputs: 1. Tape Head	1.25 mV into 50K Ω
2. Radio, Tuner	35 mV into 50K Ω
3. Magnetic P.U.	1.5 mV into 50K Ω
All input voltages are for an output of 250mV. Tapc and P.U. inputs equalised to RIAA curve within ± 1dB. from 20Hz to 20KHz.	
Bass Control	± 15dB at 20Hz
Treble Control	± 15dB at 20 KHz
Filters: Rumble (High Pass)	100Hz
Scratch (Low Pass)	8KHz
Signal/Noise Ratio	better than -65dB
Input overload	+ 26dB
Supply	+ 35 volts at 20mA
Dimensions	292mm x 82mm x 35mm

ONLY £13.15

SPECIAL COMPLETE KIT COMPRISING 2 AL50's, 1 SPM80, 1 BMT80 & 1 PA100 ONLY £25.30 FREE p. & p.

Giro No. 388-7006

Please send all orders direct to warehouse and despatch department

BI-PAK

P.O. BOX 6, WARE - HERTS

Postage and packing add 11p. Overseas add extra for airmail.

Minimum order 55p. Cash with order please.

Guaranteed Satisfaction or Money Back

Why pay more - look at our Fantastic Bargain Offer!

PENTHOUSE

A COMPLETE AUDIO SYSTEM

An all "White" Hi-Fi Stereo System to blend with modern furnishings. Solid state, fully transistorised tuner/amplifier with Stereo Multiplex Decoder, 4 wavebands Long/Medium/Short/VHF, 8 watts per channel (music power) output. The latest BSR CI29 4 speed Mono/Stereo record changer. Two white matching bookshelf speaker units. Also available in teak finish. **OUR PRICE £55.00**

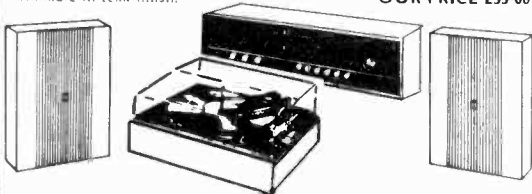

Credit terms £5.00 deposit plus £2.00 p. & p. followed by 12 payments of £5.00. Total Credit Terms £65.00 SEND £7.00 TODAY.

KLINGER

FIVE NINETY THREE UNIT AUDIO SYSTEM with BSR McDonald 4-speed Record Player, matching 4-unit Loud-speaker Systems and FREE Stereo Headphones.

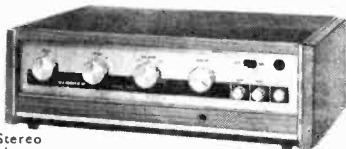

High performance Stereo Amplifier designed for home entertainment at economical cost. Represents a considerable advance in solid state, high fidelity stereo amplifiers. Outstanding performance is allied to meticulous construction, comprehensive facilities, installation simplicity and attractive styling. 10 watt RMS per channel; push button selectors; tone controls; balance control; tape record and replay facilities. Stereo headphone socket on front panel with automatic speaker muting; Teak finish. **Our price £75.00 + £2.00 p. & p.** Credit Terms £7.50 deposit + £2.00 p. & p. 18 monthly payments of £4.75 (total £93.00) SEND £9.50 TODAY.

THE AVON AUDIO SYSTEM

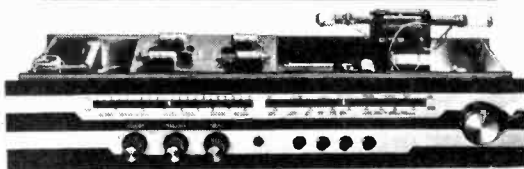

The uncabineted system is ideal as an economical replacement for an outdated chassis. The Stereo Tuner Amplifier with medium, long and short wavebands provides Worldwide coverage, even the weakest continental stations can be received with superb clarity. Push button band selection, 10 watts total output. Frequency response 25-18000 Hz.

LATEST BSR STEREO/MONO RECORD CHANGER plays all types of 7in., 10in., and 12in. Mono or Stereo records. Manual or automatic play.

TWIN ELLIPTICAL SPEAKERS. These low impedance, permanent magnet units have been specially selected to provide the fullest range of audio reproduction.



EASY TO INSTALL—NO TECHNICAL KNOWLEDGE REQUIRED. List Price £45.74. **OUR PRICE £35.00.** Credit Terms £3.50 deposit plus £2 Post & Packing followed by 12 payments of £3.15 (Total Credit Terms £41.30) Don't miss this bargain. **SEND £5.50 TODAY**

ALL EQUIPMENT COVERED BY OUR 12 MONTHS FULL GUARANTEE

CALLERS WELCOME

LEWIS radio

P/123

100 Chase Side, Southgate, London N14 5PL
Tel: 01-886 3733/9666



for fast, easy reliable soldering
Ersin Multicore Solder contains 5 cores of non-corrosive flux, instantly cleaning heavily oxidised surfaces. No extra flux is required.

EASY-TO-USE DISPENSERS



Size 5
Savbit alloy
18 swg, 18p (illustrated).
Size 19A
60/40 alloy
18 swg, 18p
Size 15
60/40 alloy
22 swg, 22p

IDEAL FOR HOME CONSTRUCTORS

Size 1 cartons in 40/60, 60/40 and Savbit alloys in 7 gauges 25p



Size 12 REEL
for Service Engineers and Electricians.

18 swg Savbit alloy. 75p



BIB WIRE STRIPPER AND CUTTER

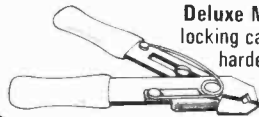

Deluxe Model 9 Automatic opening spring, locking catch, plastic-covered handles. Case hardened and precision ground. Adjusts to most wire sizes. Cuts and strips flex, splits plastic twin flex. 75p

Prices shown are recommended retail, excluding V.A.T. From Electrical and Hardware Shops. If unobtainable, send 10p p&p direct to: **Multicore Solders Ltd., Hemel Hempstead, Hertfordshire HP2 7EP**

AMAZING MINI-DRILL



FOR PRECISION MODEL WORK



+ 6 TOOLS

ONLY £2.55
p.p. 10p

Indispensable for precision drilling, grinding, polishing, etching, gouging, shaping. Precision power for the enthusiast. Shockproof. Completely portable power from 4½ volt external battery. So much more scope with MINI-DRILL. Super Kit (extra power, interchangeable chuck) £6.35 p.p. 13p. De Luxe Professional Kit with 17 tools £9.40 p.p. 23p. Prices include V.A.T.

Money ref. g'tee **MERLIN SUPPLY CO.**

Dept. PW 1273 Nailsea, Bristol BS19 2LP

MASSIVE CLEARANCE BARGAINS

Bargain component parcels contain Resistors, Capacitors, Switches, Potentiometers, Knobs, IF's, Tag Strips, Drive Drums, Transistor Panels etc., etc. Save yourself £5 on these well selected parcels 6lbs net weight **£1.00**, p. p. 40p.

Assorted Electrolytic Capacitors, 6lbs net weight **£1.00**, p. p. 40p.

Brand new Wire-wound Resistors, Good Selection. 100 for **£1**, p. p. 15p. Mullard Ferrite Pencil Magnets 1½" x ½". 100 for **£1.25**, p. p. 16p.

Assorted Computer Panels. These panels are exceptionally good value and contain a minimum of 75 transistors, stacks of diodes plus Trim Pots, Polyester Capacitors, Resistors and include a few I.C.s. 10 panels for **£1.00**, p. p. 25p.

Mullard Ferrite Cores. LA3 100 to 500kHz 50p, LA4 10 to 30kHz 75p LA2100 3 to 200kHz 50p.

Please include 10% V.A.T. to total cost of goods. **Mail Order Only.**

XEROZA RADIO

1 EAST STREET, BISHOPS TAWTON, DEVON

TOP QUALITY — LOW COST



RADIO — STEREO EQUIPMENT

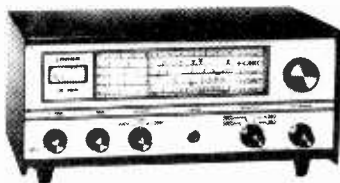
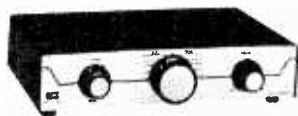

P.R.40

SOLID STATE R.F. PRESELECTOR

The PR40 R.F. Preselector is the solid state version of the world famous PR30 which is now superceded.

It employs Silicon "N" Channel FET (Field Effect Transistor) front end, followed by silicon NPN Broad Band R.F. Amp., and will substantially improve receiver performance over the range 1.5 to 35 MHz, providing a considerable increase in gain up to an overall average of 30 dB, with improved image rejection and noise ratio.

Supplied complete with co-ax plug (less standard 9 volt PP6 Battery), 12 months Guarantee.

£10.12 V.A.T./Carr. Paid.

CR70A

COMMUNICATION RECEIVER

The CODAR CR70A is an outstanding general coverage communication receiver, ideal for the keen S.W.L.

It tunes from 540 metres medium through to 10 metres with no gaps. Covers shipping, coastguard and distress frequencies, all six amateur bands 160-10 metres, International broadcast, Met. stations etc. etc. giving world-wide reception. Exclusive features include Air-spaced CODAR-COIL Hi-"Q" Aerial input, illuminated Meter and Slide Rule Scale, Two Speed vernier tuning, Switched B.F.O. for CW/SSB signals. Separate output for Tape recorder.

Ready to plug in to 200/240 volts A.C. it only needs your aerial and a 2/3 ohm loudspeaker to bring the world to your finger tips. 12 months full guarantee. Complete ready built. £31.00 V.A.T./Carr. Paid.

SEND FOR YOURS TODAY!

FREE LEAFLETS ON REQUEST.

NOTE: These CODAR Receivers meet the B.R.E.M.A. specification for Communication Receivers. Some portable receivers being advertised as Communication Receivers do not meet these requirements.

TRADE DESCRIPTIONS ACT 1968

It is illegal to make false claims or misleading statements in advertising. The following are just a few extracts from the many letters received from satisfied customers. All are unsolicited and can be inspected at any time.

Mr. S. Keightly, Southsea, Hants.
I am delighted with the CODAR equipment I am using . . . everything has come up to your specifications.

Dr. R. E. Wood, Louisiana State University, U.S.A.
Congratulations on an excellent product. The PR40 Preselector is the first preselector I have found to operate efficiently with ample gain, and without feedback or image problems.

Mr. W. R. Jones, Woy, N.S.W., Australia.
The PR40 peaked signals remarkably and performed as you claim. I am very satisfied.

M. G. Bennett, Bath, Somerset.
I am very pleased with my CR70A—results are excellent with many overseas stations I have not heard before and excellent results on the Amateur Bands.

Mr. J. Macdonald, Coningsby, Lincoln.
Received Multiband Kit OK. Assembled it in two hours, worked a treat first time.

Mr. E. Joy, Chesham, Bucks.
The performance of the CR70A is out of this world for its price, and its construction and design, great. I am really delighted . . . I cannot fault it.



MULTIBAND-6

SOLID STATE
SHORT WAVE RECEIVER KIT

All transistor T.R.F. Receiver tunes 550 KHz to 30 MHz (540 to 10 metres) complete coverage—no gaps. Medium waves—Trawlers—Ship/Shore Telephone—All Six Amateur Bands 160-10 metres—International Broadcast from Australia, Far East, Russia, USA etc. using 4 miniature plug in Coils.

Hi-Gain FET Regen, Det./AF/AF Module giving full loudspeaker output to any external 2/3 ohm speaker. Receives AM/CW/SSB.

Separate Electrical Bandsread, Calibrated Main Tuning.

A Quality CODAR-KIT with 12 months Guarantee. No technical knowledge required, simple to built, printed circuit and Pictorial Instruction Manual, fully detailed step by step.

Complete Kit with 4 Coils (less standard PP6 battery).

£14.90 V.A.T./Carr. Paid.

NEW! HI-FI STEREO EQUIPMENT

NOW AVAILABLE FROM CODAR—A COMPLETE RANGE OF QUALITY EQUIPMENT SELECTED BY US FOR TOP RESULTS AND MONEY VALUE—PLUS OUR BIG CASH DISCOUNTS!

SEND FOR FREE ILLUSTRATED BROCHURES NOW

NEW! AMTRON KITS

We are now also marketing the outstanding range of AMTRON Kits. The quality of these Kits is first class, with circuit details and drawings making construction simplicity itself.



ON THE DESIGN STAFF—
G3SZM G3IRE

CODAR

TELECOMMUNICATIONS AND ELECTRONIC
EQUIPMENT SUPPLIERS TO H.M. AND OVERSEAS
GOVERNMENTS

VALCON WORKS · BURRELL BUILDINGS · CHURCHILL INDUSTRIAL ESTATE · LANCING · SUSSEX

Tel. 090-63-61901

BN15 - 8TZ

FREE

Headphones or Speakers; Suitably Terminated Connectors; Handbook; Carriage; Insurance. In addition a JOYSTICK V.F.A.; JOYMATCH A.T.U.; feeder external mounting insulators are supplied FREE or greatly reduced when you buy a PARTRIDGE PACKAGE.

A PARTRIDGE PACKAGE constitutes a COMPLETE RADIO STATION—ready to use however confined your domestic space. The World renowned TRIO range of Communications Receivers and Transceivers, the WORLD RECORD, internationally patented JOYSTICK V.F.A. (all band aerial) only 7' 6" long (assembled) and a JOYMATCH aerial tuning unit, a pair of matching headphones or internal speaker, plus accessories, go to complete your READY TO USE RADIO STATION at a price that truly represents VALUE FOR MONEY!

PARTRIDGE PACKAGE

No. 1 with Gen. Coverage AM/CW/SSB (MW/SW) 9R59DS Receiver	£67.77 (Save £17.16)
No. 2 with Amateur Bands 80 thru 10m AM/CW/SSB JR310 Receiver	£90.97 (Save £22.35)
No. 3 with Amateur Bands 160 thru 10m plus 2m AM/CW/SSB JR599	£176.00 (Save £30.48)
No. 4 with Amateur Bands 80 thru 10m TS/PS 515 Transceiver, 180w	£231.00 (Save £37.08)

Access/Barclaycard orders accepted by 'phone

JOYSTICK V.F.A. £13.75; JOYMATCH TX/RX A.T.U. 111A 1.6-32MHz £13.75; JOYMATCH A.T.U. 111 RX only 500kHz-32mHz £13.75; JOYMATCH A.T.U. LO-Z500 TX/RX 500w SSB (PA input), Built-in RF meter £19.91; Communications 8Ω headphones (suitable TRIO, EC10 etc.) £3.14; Matching Speaker (with instructions for internal fitting in 9R59DS & JR310) £2.00; TRIO: Linear Amplifier TL911 £172.15; TR2200 2m personal transceiver £87.45; TR7200 2m car transceiver £142.45; Spare set valves for 9R59DS £2.35; OA2 Mains Stabiliser 74p.

NEW : World-wide reception on the amazing "DX-CRYSTAL SET" £2.42 incl. unique aerial.

NEW : AMTRON QUALITY KITS—send for brochure and prices.

PARTRIDGE BUDGET LINE

Artificial Earth—solves receive and transmit earth problems (as used on North Sea Oil Rigs!) £5.80; Aerial Bandswitch—tuned aerial for domestic receivers £5.80; A.T.U. KIT—for use with transmitters and Communications Receivers £5.80; (assembled £7.01); Mini SWR Bridge—1.8 to 180mHz, 2kw P.E.P., 75 or 50Ω, SO239 sockets; 1:1 to 1:3 ratio, 80 x 30 x 30mm £5.60. (All prices quoted INCLUDE V.A.T., CARRIAGE, PACKING, INSURANCE.)

Send 3½p stamp for full illustrated details. Special TRIO brochures (state which) 3½p stamp extra.

NO V.A.T. ON OVERSEAS ORDERS!

Carriage and insurance extra overseas orders

BOX 5



G3CED — G3VFA

Telephone: 0843 62535 or 62839 evenings and weekends

verobox

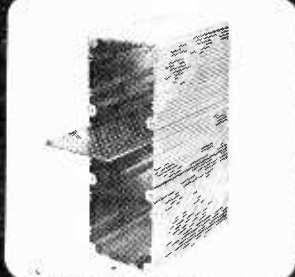

ALUMINIUM ENCLOSURES

- 80 standard sizes available from stock.
- Made from precision extrusions with integral board guide slots.
- Finned sides improve appearance and radiate heat.
- Parallel sides for ease of component mounting.



VERO ELECTRONICS LTD.

Eastleigh, Hants. SO5 3ZR

Tel: Chandler's Ford 2952 Telex: 47551

Subsidiaries and Agents throughout the World.

EX COMPUTER PC PANELS

2 x 4 in. packed with semiconductors and top quality resistors, capacitors, diodes etc. Guaranteed min. 35 transistors plus data. 10 boards 50p (12p)

SPECIAL BARGAIN PACK

25 boards for £1 (30p)
Panels with 4 Power transistors sim OC28 50p (10p)

ELECTROLYTICS

6000μ 75v 4½ x 2in. dia	55p (14p)
5000μF 90v, 8000μ 55v 4½ x 3in dia	50p (24p)
10,000μ 35v, 5,000μ 35v 4½ x 2in	40p (12p)
2000μ 25v wire ends	15p (6p)
3A diodes	4 for 50p (7p)
250 mixed capacitors	60p (9½p)
250 mixed resistors	60p (9½p)
250 mixed HI-STAB resistors	60p (9½p)
200 Si Plana diodes	50p (7p)
Sub-min co-ax. connectors	4 prs. 50p (7p)
Min. glass neons	12 for 50p (7p)
Reed Relays mixed	10 for 50p (7p)
Micro switches	8 for 50p (9p)
Assorted Relays	8 for £1 (18p)
10 way terminal blocks	10 for 55p (15p)
Papst extractor/blower fans	100 c.f.m.
4½ x 4½ x 2in.	£3.50 (28p)
Q.H. bulbs 12v 55w	50p (6p)

Postage and package shown in brackets. Please add 10% VAT to prices.

KEYTRONICS

(Mail Order only)

44 EARLS COURT ROAD
LONDON W8. 01-478 8499

BABANI PRESS

NEW TITLES!

BP10. Modern Crystal and Transistor Set Circuits for Beginners by B.B. Babani 35p

201. Practical Transistorised Novelties for Hi-fi Enthusiasts by B.B. Babani 35p

AVAILABLE NOW

FROM ALL GOOD RADIO COMPONENT AND HI-FI SHOPS, BOOK SHOPS, MAIL ORDER COMPANIES AND MANY OF THE LARGER BRANCHES OF W. H. SMITH & SON LTD IN MAJOR TOWNS

BERNARDS(publishers)LTD

ALL OUR PRICES INCLUDE V.A.T.

BSR HI-FI AUTOCHANGER STEREO AND MONO

Plays 12", 10" or 7" records Auto or Manual. A high quality unit backed by BSR reliability with 18 months' guarantee. AC 200/250v. Size 18 1/2 x 11 1/2. Above motor board 3 1/2 in. Below motor board 2 1/2 in. With STEREO and MONO XTAL



£6.25 Post 25p.

PORTABLE PLAYER CABINET £4.50

Modern design. Black varnish covered. Silver front grille. Padded Lid. Chrome fittings. Post 25p. Motor board out for BSR deck.

4 TRANSISTOR MONO AMPLIFIER

Powerful 3 watt output. 16 ohm. AC mains operated with transformer. 3-Controls, volume, treble, bass and On/Off switch with knobs. Ready made on printed circuit board. Fused inputs and outputs. Famous make. Size 8 in. wide x 4 in. deep x 3 in. high. Suitable 7" x 4" speaker. £1. Price £5.95 Post 25p

BSR JUNIOR SINGLE PLAYER

Heavy duty 4-speed motor with separate pick-up arm fitted LP/78 turnover motor compatible cartridge. £4.95



GARRARD DECCA HI-FI DECK

Single play Stereo/ Mono Duram transcription head and arm. Four speeds. 10 1/2 in. turntable. Anti-rumble filter. Bias compensation. Laboratory motor. £18.50 Post 25p Ideal for Disco-Deck



METAL PLINTH AND PLASTIC COVER £4.95

Cut out for most Garrard or B.S.R. Most will play with cover in position. 12 1/2 x 14 1/2 x 7 1/2 in. Covered in black leatherette. Post 35p

ALSO AVAILABLE IN SOLID NATURAL MAHOAGANY WAX POLISHED FINISH—AT SAME PRICE

COMPACT PORTABLE STEREO HI-FI

Two full size loudspeakers 18 1/2 x 10 x 3 1/2 in. Player unit clips to loudspeakers making it extremely compact. Overall size only 18 1/2 x 10 x 3 1/2 in. 3 watts per channel. Plays all records 33 rpm. 45 rpm. Separate volume & tone controls. 240v AC mains. Attractive Teak finish Weight 18lbs. Bargain Price £25 85p carriage



SPECIAL OFFER! SMITH'S CLOCKWORK 15 AMP TIME SWITCH

Single pole two-way Surface mounting with fixing screws. Will replace existing well switch to give light for return home, garage, automatic anti-burglar lights etc. Turn on or off at full or intermediate settings. Two types available. Type 'A' 0 to 60 minutes or Type 'B' 0 to 6 hours. Fully insulated. Makers last list price £4.50. Brand new and fully guaranteed. OUR PRICE £1.65 or £3 pair. Post 25p. (PLEASE STATE TYPE A OR B WITH ORDER)



BLANK ALUMINIUM CHASSIS 18 s.w.g. 2 1/2 in sides 6 x 4 in 45p; 8 x 6 in 53p; 10 x 7 in 65p; 12 x 8 in 85p; 14 x 9 in 90p; 16 x 9 in 90p; 12 x 8 in 60p; 16 x 10 in 81p. ALUMINIUM BOX 3 x 3 x 3 in 60p; 4 x 4 x 4 in 70p; 6 x 4 x 4 in 80p; 9 x 4 x 4 in 1.12; 12 x 4 x 4 in 1.30. ALUMINIUM PANELS 18 s.w.g. 6 x 4 in 9p; 8 x 6 in 15p; 14 x 8 in 16p; 10 x 7 in 19p; 12 x 6 in 20p; 12 x 8 in 25p; 16 x 8 in 25p; 14 x 9 in 24p; 12 x 12 in 40p; 16 x 10 in 50p. PAXOLIN PANEL 10 x 8 in 15p.

1 1/2 inch DIAMETER WAVECHANGE SWITCHES, 25p. 2 p. 2-way, or 2 p. 6-way, or 3 p. 4-way, 25p each. 1 p. 1 2-way, or 4 p. 2-way, or 4 p. 3-way, 25p. TOGGLE SWITCHES, sp. 14p; dp. 22p; dp. dt. 22p. Sub-miniature, sp. 30p; dp. 37p; dp. dt. 45p.

R.C.S. STABILISED POWER PACK KITS All parts and instructions with Zener Diode. Printed Circuit Bridge Rectifiers and Double Wound Mains Transformer. Input 200/240V a.c. Output voltages available 6 or 9 or 12 or 15 or 18 or 20V d.c. at 100mA or less. PLEASE STATE VOLTAGE REQUIRED. £2.20 Post Details S.A.E. Size 3 1/2 x 1 1/2 x 1 1/2 in.

R.C.S. GENERAL PURPOSE TRANSISTOR PRE-AMPLIFIER BRITISH MADE Ideal for Mike, Tape P.U., Guitar, etc. Can be used with Battery 9-12v. or H.T. Line 200-300V. D.C. operation. Size 1 1/2 x 1 1/2 x 1 1/2. Responses 25 c.p.s. to 25 Kc/s, 28 db gain. For use with valve or transistor equipment. 99p Post Full instructions supplied. Details S.A.E.

NEW TUBULAR ELECTROLYTICS		CAN TYPES	
4/350V 14p	250/25V 14p	50+50/300V 50p	50p
4/350V 14p	500/25V 20p	80+100/350V 80p	80p
8/450V 16p	1000/25V 35p	32+32/450V 20p	45p
16/450V 22p	1000/50V 47p	32+32/450V 45p	45p
32/500V 35p	8+8/450V 25p	250+50/325V 55p	55p
25/25V 10p	8+16/450V 25p	32+32+32/350V 55p	55p
50/50V 10p	16+16/450V 40p	100+50+50/350V 55p	55p
100/25V 10p	32+32/350V 40p		

LOW VOLTAGE ELECTROLYTICS 1, 2, 4, 5, 8, 16, 25, 30, 50, 100, 200mF 15V 10p. 500mF 12V 15p; 25V 20p; 50V 25p; 100V 47p; 100V 70p. 1000mF 5V 25p; 25V 42p; 50V 57p. 2500mF 6V 65p; 3000mF 25V 47p; 50V 55p. 5000mF 6V 25p; 12V 42p; 25V 70p; 35V 85p; 50V 95p. CERAMIC 1pF to 0.01mF, 4p. Silver Mica 2 to 5000pF, 4p. PAPER 350V-0.1 4p; 0.6 13p; 1mF 15p; 2mF 150V 15p. 500V-0.001 to 0.01 4p; 1 1p; 0.25 8p; 0.47 25p. SILVER MICA. Close tolerance 1p; 2-2000pF 3p; 500-2.200pF 10p; 2.700-5.800pF 20p; 6.800pF-0.01, mid 30p each. TWIN GANG. "0-0" 200pF+170pF, 65p. Slow motion drive 385pF+385pF with 25pF+25pF, 50p; 500pF standard 65p; small 3-gang 500pF 11.60. SHORT WAVE SINGLE. 10pF, 30p; 25pF, 55p; 50pF, 55p.

SHORT WAVE SINGLE GANG. Precision Silver Plated Gangable Tuning Condensers. Values up to 100pF. 50p each Section Couplers supplied FREE with two or more gangs.

NEON PANEL INDICATORS. 250V AC/DC Amber, 20p. RESISTORS. 1/2 w. 1 w. 2 w. 10p; 2 w. 5p. 10 1/2 to 10M. HIGH STABILITY. 1 w. 2 1/2 10 ohms to 6 meg., 10p. DITTO 2%. Preferred values 10p; 10 meg., 4p. WIRE-WOUND RESISTORS. 5 watt, 10 watt, 15 watt, 10 ohms to 100K, 10p each; 5w 0.5 ohm to 8.2 ohms 10p. TAPE OSCILLATOR COIL. Valve type, 35p.

MAINS TRANSFORMERS ALL POST 95p each

Eagle MT12 12-0-12V 50MA 90p
250-0-250 80 mA. 6-3 v. 3-5 a. 6-3 v. 1 a. or 5 v. 2 a. £2.50
350-0-350 80 mA. 6-3 v. 3-5 a. 6-3 v. 1 a. or 5 v. 2 a. £2.00
300-0-300 v. 120 mA. 6-3 v. 4 a. O.T.; 6-3 v. 2 a. £2.25
MINIATURE 200 v. 45 mA. 6-3 v. 1 a. 2 1/2 x 2 1/2 in. 75p
MIDGET 220 v. 45 mA. 6-3 v. 2 a. 2 1/2 x 2 1/2 in. 90p
HEATER TRANS. 6-3 v. 8a. 60p
GENERAL PURPOSE LOW VOLTAGE. Tapped outputs at 2 amp., 3, 4, 5, 6, 8, 9, 10, 12, 15, 18, 24 and 30 v. £2.80
1 amp., 6, 8, 10, 12, 18, 18, 20, 24, 30, 36, 40, 48, 60 £2.80
2 amp., 6, 8, 10, 12, 18, 18, 20, 24, 30, 36, 40, 48, 60 £2.80
5 amp., 6, 8, 10, 12, 18, 18, 20, 24, 30, 36, 40, 48, 60 £2.75
3 amp., 3, 5, 8 and 13 v. £1.90; Ditto 3 amp., £1.90, 3 amp., 3, 5, 8, 10, 13 and 5-0-5 v. £1.30; Ditto 3 amp., £1.50; 6-0-6 v. 500 mA 90p; 9 v. 1 amp 95p; 12 v. 300 mA 75p; 12 v. 500 mA 85p; 12v. 750 mA 95p; 40v. 1 amp 11.75. AUTO TRANSFORMERS. 115v to 230v or 230v to 115v. 150v. £2.25; 500v. £2.25; 750v. £10; 1000v. £15. CHARGER TRANSFORMERS. Input 200/250v. for 6 or 12v., 1 amp. £1.50; 2 amp. £1.80; 2 amp. £2.50 BATTERY CHARGERS. Ready built with leads and clips 1 1/2 amp. £2; 4 amp. £4; 5 amp. £4.50. FULL WAVE BRIDGE CHARGER RECTIFIERS: 6 or 12v. outputs. 1 1/2 amp. 40p; 2 amp. 55p; 4 amp. 85p.

MAINS ISOLATING TRANSFORMER

Primary 0-110-240v. Secondary 0-240v. 3 amps. 720 watts. Insulated terminals. Varnish impregnated. Fully enclosed in steel case with fixing feet. £10 Carr. Famous make. (Value £19) OUR PRICE 50p Can be used as 800 watt auto transformers 240-110V.

SET OF 3 MOTORS FOR COLLARO STUDIO TAPE DECK £2.50 Post 50p.

VOLUME CONTROLS 80 Ohm Coax 4p. rd.

Long spindles. Midget Size 5 K. ohms to 2 Meg. LOG or LIN. L/S 15p. D.P. 25p. STEREO L/S 55p. D.P. 25p. Edge 5K. S.P. Transistor 25p
Wirewound controls 1 1/2 in. diam. 3 watts. 10 ohms to 100K British made with long spindles. It's 45p ea.
HELICAL POT 10k LIN List 23, Bargain 75p.
DUAL CONCENTRIC POT 500K LOG + 500K LIN D.P. switch. Inner spindle 3 1/2 in; outer spindle 2 1/2 in. 75p.

ALL PRICES INCLUDE VAT

E.M.I. 13 1/2 x 8 in. SPEAKER SALE!

With twin tweeters. And crossover. 10 £4.50 wait. State 3 or 8 or 15 ohm. As illustrated. Post 25p
With flared tweeter cone and ceramic magnet. 10 watt. £2.75 Bass res. 45-80 cps. Flux 17,000 gauss. State 3 or 8 or 15 ohm. Post 25p



Bookshelf Cabinet 16 x 10 x 9 in. Teak Veneer £5.50 Post 25p

GOODMANS 6 1/2 in. HI-FI WOOFER 8 ohm, 10 watt. Large ceramic magnet. Special Cambrie cone surround. Frequency response 30-12,000 £4 cps. Ideal P.A. Columns, Hi-Fi Enclosure Systems, etc. Suitable cabinet 12 x 8 x 24 00. Suitable Tweeter £2.00.



ELAC CONE TWEETER The moving coil diaphragm gives a good radiation pattern to the higher frequencies and a smooth extension of total response from 1,000 cps to 18,000 cps. Size 8 1/2 x 3 1/2 x 2 in. deep. Rating 10 watt, 3 ohm or 15 ohm models. £1.90 Post 25p Crossover 95p.

GOODMANS 8 in. WOOFER

3 ohm 15 watt. Deep cone. Heavy ceramic magnet. 28 resonance 35 cps. Frequency response 30-8,000 cps. Ideal bass unit for £3.75 Hi-Fi systems



LOUDSPEAKERS P.M. 3 OHMS. 7 x 4 in. £1.25; 6 1/2 in. £1.50; 8 x 6 in. £1.60; 8 in. £1.75; 10 x 6 in. £1.90; 10 in. £2.00. SPECIAL OFFER: 8 in. 10 in. 2 1/2 in. 3 1/2 in. 5 in. 2 in.; 5 in. 2 1/2 in. 3 1/2 in. 4 in.; 3 in. 4 in.; 15 ohm. £1 EACH 3 1/2 in. dia.; 5 in. 7/8 x 4 in.; 7 x 4 in.; 8 x 6 in. £1 TYPE 3 ohm, 2 1/2 in., 2 1/2 in., 3 1/2 in., 5 in., 6 in., 6 x 4 in., 8 ohm, 8 in. £1.50. RICHARD ALLAN TWIN CONE LOUDSPEAKERS. 8 in. diameter 4W £2.50, 10 in. diameter 5W £2.50; Post 25p. 12 in. diameter, 6W, £2.95; 3 or 8 or 15 ohm models. SPEAKER COVERING MATERIALS. Samples Large S.A.E. FERITE ROD 3" x 1/2" 20p; 6" x 1/2" 20p; 8" x 1/2" 20p. Horn Tweeters 2-10K/4. 1W 2 ohm or 15 ohm £1.95. De Luxe Horn Tweeter 2-18 K/4. 15W or 15 ohm £2.50. TWO-WAY 3,000 c.p.s. CROSSOVERS 3, 8 or 15 ohm 95p.

TWO-WAY CROSSOVER NETWORK 3,000 c/s With variable tweeter attenuator giving accurate high/low frequency balance. Mounted on panel 5 1/2 in. x 4 in. with control knob, tweeter and woofer leads and input £2.20 Post terminals. Suitable for 8 to 8 ohm impedances.

VALVE OUTPUT TRANSFORMER 25p MIKE TRANSFORMER MU. metal 100-1 15 ohms. 50 WATT MULTI RATIO. 3, 8 and 15 ohms, 80p. FULL FULL VALVE OUTPUT TRANSFORMERS. 50 watt £1.30 100 watt £1.4

ELECTRO MAGNETIC PENDULUM MECHANISM

1.5v d.c. operation over 100 hrs. continuous on SP2 battery. fully adjustable swing and speed. Ideal displays teaching electro magnetism or for metronome; strobe etc. 95p. Post 25p

BRITISH MADE STEREO MULTIPLEX DECODER

Brand New. 7 transistors plus integrated circuit. Fibre glass printed circuit board. Size 2 1/2 x 8 1/2 in. Pre-aligned. Complete with stereo beacon indicator. 12V d.c. operation. 400mV output for 100MV input. Full instructions for any FM Tuner. Some technical experience essential. £6.50 DIPOLE LOFT AERIAL £1.50. 300 OHM CABLE 4p yard. Post 15p 800 OHM CABLE 5p yard.



COAXIAL PLUG 10p. PANEL SOCKETS 10p. LINE 18p OUTLET BOXES, SURFACE MOUNTING 25p. BALANCED TWIN RIBBON FEEDER 300 ohms, 5p rd. JACK SOCKET 8id. open-circuit 14p, closed circuit 25p; Chrome Lead Socket 45p; Phono Plug 5p; Phono Socket 5p JACK PLUGS 8id. Chrome 15p; 3-5mm Chrome 15p. DIN SOCKETS chassis 3-pin 10p; 5-pin 10p. DIN SOCKETS Lead 3-pin 15p; 5-pin 15p. DIN PLUGS 3-pin 15p; 5-pin 25p. VALVE HOLDERS 5p; CERAMIC 8p; GANS 5p.

BRITISH FM/VHF TUNING HEART

88 to 108 Mc/s British made. 2 Transistors better aligned—requires 10.7 switch IF. Complete with tuning gear. Connections supplied but some technical experience essential. Post 20p. £3.95

RADIO COMPONENT

Illustrated Colour Brochure, Radio Books & Component Lists 10p. Written guarantee.

ALL OUR PRICES INCLUDE V.A.T.

E.M.I. WOOFER AND TWEETER KIT

THE PAIR. Post 25p.
(Available separately.
Woofer £4.25; Tweeter
£1.90).
Comprising a fine example of a Woofer
10½" x 6½in. with a massive Ceramic
Magnet. 44oz. Gauss 13,000 lines.
Aluminium Cone centre to improve
middle and top response. Also the E.M.I.
Tweeter 8½in. square has a special
lightweight paper cone and magnet flux
10,000 lines. Crossover condenser and
full instructions supplied.
Impedance Standard 8 ohms
Maximum power 12 watts
Useful Response 25 to 18,000 cps
Bass Resonance 45 cps



£9.90
Post 25p

SUITABLE ENCLOSURE 20" x 13" x 9in.
MODERN DESIGN. TEAK WOOD FINISH.

8in. or 10in. ELAC HI-FI SPEAKER

Dual cone plasticised roll sur-
round. Large ceramic magnet.
50-16,000 cps. Bass resonance
55 cps. 8 ohm impedance.
8in. 10 watts, £3.75
10in. 12 watts



TEAK VENEER HI-FI SPEAKER CABINETS

Fluted Wood Fronts

MODEL "A". 20" x 13" x 9in.
For 12in. dia. or £9.90 Post
10in. speaker. 25p
MODEL "B". 16" x 10" x 9in.
For 8" x 8in. or £5.50 Post
8in. speaker. 25p
MODEL "B2" ditto. Triangular
corner version.
MODEL "C". 16" x 8" x 6in.
For 8" x 8in. £4.40 Post
speaker. 25p
LOUDSPEAKER CABINET
WADDING 18in. wide, 15p ft.



BARGAIN AM TUNER.

Medium Wave.
Transistor Superhet £4.95
Ferrite aerial. 9 volt.
BARGAIN 4 CHANNEL
TRANSISTOR MONO
MIXER. Add musical
highlights and sound effects
to recordings. Will mix
Microphone, records, tape
and tuner with separate
controls into single output
9 volt battery £3.95
operated.

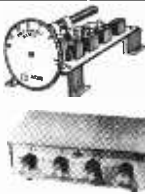

STEREO VERSION OF ABOVE £5.95.

BARGAIN FM TUNER.

88-108 Mc/s Six Transistor.
9 volt. Printed circuit.
Calibrated dial tuning.
Walnut Cabinet. £12.85
Size 7" x 5" x 4in.
BARGAIN FM TUNER. £8.85
As above less cabinet.
BARGAIN 3 WATT AMPLIFIER. 4 Transistor
Push-Pull Ready built with volume, treble and
bass controls. 18 volt battery operated. £4.50



THE "INSTANT" BULK TAPE

ERASER & HEAD DEMAGNETISER.
Suitable for cassettes, and all sizes of
tape reels. A.C. mains 200/250V.
Leaflet S.A.E. £2.50 Post
20p



WAFER HEATING ELEMENTS

THIN
OFFERING 1001 USES for every type of heating and
drying applications in the home, garage, greenhouse,
factory (available in manufacturing quantities). Approx.
size 10½" x 8½" x ¼in. Operating voltage 200/250V. a.c.
250 watts approx. Printed circuit element enclosed in
asbestos fitted with connecting wires. Completely flexible
providing safe Black heat. British-made for use in photo-
copiers and print drying equipment.
Ideal for home handymen and experimenters. Suitable
for Heating Pads, Food Warmers, Convecter Heaters, etc.
Must be clamped between two sheets of metal or asbestos,
etc. to make efficient clothes dryers, towel rails—Ideal for
slicing cupboard. Ideal for anti-frost device for the garage
—preventing frozen radiators or acting as oil sump heater.
Use in the greenhouse for seed raising and plant protection.
Invaluable aid for bird houses, incubators, etc., etc. Can
be used in series for lower heat. Or in parallel for higher
heat applications.

ONLY 40p EACH (FOUR FOR £1.50)
ALL POST PAID—Discounts for quantity.

BAKER MAJOR 12" £9.90



Post Free
30-14,500 c/s. 12in. double
cone, woofer and tweeter cone
together with a BAKER
ceramic magnet assembly
having a flux density of
14,000 gauss and a total flux
of 145,000 Maxwells. Bass
resonance 40 c/s Rated 20
watts. NOTE 3 or 8 or
15 ohms must be stated.

Module kit, 30-17,000 c/s
with tweeter, crossover, baffle
and instructions. £12.50

Please state 3 or 8 or 15 ohms. Post Free

BAKER "BIG SOUND" SPEAKERS

Robustly constructed to stand up to
long periods of electronic power.
As used by leading groups.
Useful response 30-13,000 cps.
Bass Resonance 55 cps.

GROUP "25" £8.80
12in. 25 watt
3, 8 or 15 ohms. Post Free

GROUP "35" £9.90
12in. 35 watt
3, 8 or 15 ohms. Post Free

GROUP "50" £22.00
15in. 50 watt
8 or 15 ohms.

NEW 12" £17.60
VERSION



MAJOR 100 WATT

ALL PURPOSE TRANSISTOR AMPLIFIER

All purpose transistorised.
Ideal for Groups, Disco and P.A.
4 inputs speech and music. 4 way
mixing. Output 8/15 ohm. a.c. Mains.
Separate treble and bass controls.
Guaranteed. Details SAE.



£49 Carr.
£1.00

Q MAX CHASSIS CUTTERS

A die, punch and Allen Screw

Size	Price
1½"	£1.70
1½" Key 'B' for above	10p
2"	£2.25
2½"	£2.50
2½" Key 'C' for above	13p
3"	£4.50
3" Key 'E' for above	20p
3" 1" Square, with key	£2.10
4"	74p
4½"	83p
4½" Key 'T' for above	6p
5"	90p
5½"	92p
5½" Key 'A' for above	6p
6"	99p
6" 1½" x 1½" x 1½"	£1.00
6" 1½" x 1½" x 1½"	£1.15
6" 1½" x 1½" x 1½"	£1.20
6" 1½" x 1½" x 1½"	£1.35
6" 1½" x 1½" x 1½"	£1.70

SLIDER VOLUME CONTROLS



Available in both LOG and LINEAR type.
Size 3½" x ½" x ½in. with knobs.
5K, 10K, 25K, 50K, 100K,
250K, 500K, 1 MEG, 2 MEG.

65p EACH

DELUXE 4 POLE MOTOR

1,400 r.p.m. Reversible 42 Watt,
spindle 1½" x ½" size 3½" x 3".
As illustrated, 240V. AC mains. Post 25p

E.M.I. GRAM MOTOR
120v, or 240V. A.C. 2,400 rpm. 2-pole
70mA. Size 2½" x 2½" x 2½in. £1.00
Post 25p.

ONE RPM GEARED MOTOR
240V. A.C. mains. Ideal for displays/
disco lightwheels. £1.25
Post 25p.

BAKER HI-FI SPEAKERS

HIGH QUALITY — BRITISH MADE

REGENT

12in. 15 watts

An inexpensive unit for the
beginner in high fidelity and
for general purposes. May be
used to improve any Radio,
Amplifier, Hi-Fi or Television
receiver.

Bass Resonance 45cps
Flux Density 12,000gauss
Useful response 45-13,000cps
3 or 8 or 15 ohm models.

£8.80 Post Free

DE-LUXE Mk II

12in 15 watts

Especially designed to provide
full range reproduction at an
economical cost. Suitable for
use with any high fidelity
system. Built-in concentric
tweeter cone.
Bass Resonance 30cps
Flux Density 14,000gauss
Useful response 25-16,000cps
8 or 15 ohms models.

£11 Post Free

SUPERB

12in. 20 watts

A high quality loudspeaker,
its remarkable low cone
resonance ensures clear
reproduction of the deepest
bass. Fitted with a special
copper drive and concentric
tweeter cone resulting in full
range reproduction with
remarkable efficiency in the
upper register.
Bass Resonance 25cps
Flux Density 16,500gauss
Useful response 20-17,000cps
8 or 15 ohms models.

£16.50 Post Free

AUDITORIUM

12in. 25 watts

A full range reproducer for
high power, Electric Guitars,
public address, multi-speaker
systems, electric organs.
Ideal for Hi-Fi and Disco-
theques.
Bass Resonance 35cps
Flux Density 15,000gauss
Useful response 25-16,000cps
8 or 15 ohms models.

£15.40 Post Free

AUDITORIUM

15in. 35 watts

A high wattage loudspeaker
of exceptional quality with a
level response to above
8,000 cps. Ideal for Public
Address, Discotheques, Elec-
tronic Instruments and the
home.
Bass Resonance 35cps
Flux Density 15,000gauss
Useful response 20-14,000cps
8 or 15 ohms models.

£22 Post Free

Hi-Fi Enclosure Manual containing 20 plans, designs,
crossover data and cubic tables. 240p. Post Free.

CALLERS WELCOME • CUSTOMERS FREE CAR PARK

OPEN 9-6. WEDNESDAY 9-1. SATURDAY 9-5. Closed for lunch 11-15-2-30

SPECIALISTS

337 WHITEHORSE ROAD . CROYDON

(Exports Remit cash and extra postage.)

Buses 50, 68, 159. Rail Selhurst

Telephone 01-684-1665

"STEAM" ROLLING

ANUAL Reports and Accounts of major organisations do not usually make exciting reading, but the latest from the IBA is different because of the entries describing the planning of independent commercial radio under the IBA banner.

Most of the information we are either aware of already, or we took for granted as being necessary minimum standards that are laid down to match the existing performance by the BBC. However, one or two interesting points emerge that have an important bearing for the listening audience.

The IBA, with very good reason, intends to encourage the major proportion of listening on v.h.f. The International Telecommunication Union is due to review the allocation of m.f. bands, under the present Copenhagen Convention and Plan, in 1974-5. Any proposed revisions are expected to take effect from 1976 and both the BBC and the IBA are expecting a reduction in the m.f. allocation largely due to "overcrowding". In the meantime both organisations continue to operate sound broadcasting on m.f. as a back-up for v.h.f.

The crunch is in sight for the listeners because it looks as if they must expect, after nearly twenty years of v.h.f. broadcasting, to convert to v.h.f. reception or go without. We have heard the pros and cons of v.h.f. and m.f. so many times that we will not pursue the matter here. Suffice it to say that the IBA are looking ahead to the "day of judgement" by planning in force for circular polarised transmitting aerials to compromise between horizontal and vertical polarised receiving aerials.

The m.f. transmitting aerials will be directional systems using three or four mast radiators so that several stations can transmit over a restricted area on 1151kHz. The radiated power will vary from one station to another, depending on local conditions, but in London it will be 0.5 to 1kW; elsewhere up to 5kW, with an 8kW mf1 and 30kW mf2 signal from Saffron Green (not until later next year) for London, when the IBA have finished with the installations at Lots Road Power Station.

The method of m.f. transmission adopted is not commonly used in Europe and it makes one wonder why not, even if large sites are necessary.

The other disturbing thought is the increasing availability of stations broadcasting on v.h.f. With the undesirable side-effects (such as "birdies" and inter-modulation distortion) and the greater sensitivity of tuner front-ends, we forecast a congestion (or indigestion!) problem on v.h.f. in the U.K. within the next five years. Some serious thinking and re-appraisal is therefore going to be needed with a view to extending the broadcast v.h.f. range below 88MHz; although we understand that a clash has occurred in Hertfordshire and the police service is expected to be moved to another frequency, it would be wishful thinking to expect the emergency services to be transferred out of their present 97MHz-plus domain.

M. A. COLWELL—*Editor*

The January issue, on sale 7th December, will include an Ultrasonic Remote Control Unit to switch on the television, radio, lamps, or almost any electrical device or appliance, without moving out of your armchair; a practical way of housing plug-in circuit boards; a signal generator for testing and fault finding in radio and audio equipment; an article dealing with radio interference problems in audio equipment; and first details of our plans for some of the spring issues of Practical Wireless, including some superb new ideas to help you make the most of d.i.y. radio and electronics.

Further details on page 751.

NEWS...

Mid-Lanark A.R.C.

THE above club has sent us some details of the future programme. There will be a bring-and-buy sale on Nov. 9, a demonstration of stereo radio and quadraphonic sound by GM3UCI on the 23rd and the A.G.M. on December 7th. December 21st is called "Oklahoma" and GM3BVU will give a talk on Amateur radio in the U.S.

Meetings are held at 7.30 in the Wrangholm Hall Community Centre, Jerviston Road, Motherwell.

Sonex 74

THE venue for Sonex 74 European High Fidelity Exhibition will be The Post House Hotel, London Airport and the dates March 29th to March 31st.

WIRELESS TELEGRAPHY ACT

Readers and advertisers are reminded of the requirements laid down by the Wireless Telegraphy Act. It is an offence in the U.K. to install or operate wireless telegraphy apparatus except under the provisions of the Act and, except in the case of broadcast sound-only receivers, a licence must be obtained from the Minister of Posts and Telecommunications.

Included within the provisions of the Act are any apparatus transmitting deliberate signals for any purpose such as "walkie-talkies", radio-controlled models or servos and some types of metal detectors. Apparatus radiating interference signals are subject to controls which also come under the administration of the same Ministry. If you require full information, please write to the *Ministry of Posts and Telecommunications, Waterloo Bridge House, Waterloo Road, London, SE1 8UA.*

CRATA

IS COMING

Watch P.W. for details

Open University Course

ELECTROMAGNETICS and Electronics, a Post-experience course by the Open University, aims to provide an understanding of the scientific basis of electronics and electronic circuit design.

The course is intended for those preparing for higher level university study in science and technology and for those who need a knowledge of electronics but who do intend to study at a higher level.

It assumes little prior knowledge of electronics or electromagnetics but does assume a background of scientific or technical education beyond GCE "O" Level.

The first part deals with the basic ideas of electricity, magnetism and electromagnetism, semiconductors and the properties of simple circuits. The remainder deals with electronic circuits, stressing the need to design circuits to meet specifications of noise, distortion, output voltage as well as gain and input and output impedance.

Applications are now invited for the course which starts next February and lasts until November. As with all Post-experience courses, no formal academic qualifications are needed. They are self-contained courses designed to teach new developments or update knowledge of a subject.

The course consists of 17 written correspondence units linked to 17 television and five radio programmes. Students are required to attend a one week residential summer school and encouraged to attend evening or Saturday tutorial sessions. There are 12 assignments to complete and an examination at the end of the course.

A home experiment kit, including a cathode-ray oscilloscope and a signal generator, is sent to students who are expected to design and build circuits for checking at summer school.

Some elementary mathematics is required for the course. Students should know elementary calculus, the meaning of sine, cosine and imaginary numbers. A preparatory booklet is issued at the beginning.

The course tuition fee is £45 plus £37 for the residential summer school. Application forms are available from *The Post-experience Student Office, P.O. Box 76, Milton Keynes, MK7 6AA.*

Scottish show cancelled

BECAUSE of lack of interest, the Scottish International Hi-Fi Exhibition has been cancelled. Only 12 of the expected 27 firms confirmed their bookings for the show.

The organisers feel that the reason for the lack of interest is that many companies have stretched their budgets by representation at the Harrogate and Olympia shows.

What of D.N.L. ?

PHILIPS Ltd. will be using the Dolby-B noise reduction system!!

Tyne/Wear radio contract

AFTER interviewing the six applicant groups for the Tyne/Wear radio contract, and giving full consideration to the written applications, the Independent Broadcasting Authority has announced that it has formed the view that Metropolitan Broadcasting is the leading contender.

The Authority now proposes, subject to contract, to offer the franchise to Metropolitan, the chairman of which is Sir John Hunter.

The company's programme plans will be published when it begins broadcasting — probably during the summer of 1974.

More for SQ

MORE manufacturers are getting onto the quadrasonic bandwagon by building SQ decoders into their equipment. Companies like Braun, Grundig, Korting, Philips, Revox, Saba, Sharp, Siemens have taken out SQ licences with CBS.

Physics Exhibition

THE Council of the Institute of Physics has decided that the Physics Exhibition should now be discontinued, and the show arranged for 1975 will now not take place.

In recent years the number of visitors to the exhibition has decreased considerably as have the number of industrial firms and other concerns that used to have exhibits there.

The very first Physics exhibition was held by the Physical Society in 1905. The one held in 1973 was the fifty-seventh in this series.

New 4-channel system

ANEW quadrasonic sound system devised by Duane Cooper and developed by Nippon Columbia was demonstrated at the Berlin Radio Show. The new system is called New Discrete or Discrete Matrix. It is said to have certain advantages over other quadrasonic systems because of its dual nature. A typical set-up would use a two-channel matrix for surround sound named BMX. This involves 45° phase shifts between the speakers rather than conventional 90° ones.

If increased definition in image placement should be required, a demodulator for the carrier channels on the records would be added, giving the set-up a potential 20dB separation between channels at mid-frequencies.

The Discrete Matrix system allows the two extra channels contained on the gramophone record to be of a narrow bandwidth resulting with the maximum frequency of the record being 36kHz compared with 45kHz on the CD-4 records.

Noise reduction techniques are not employed with this system, so making demodulators potentially cheaper.

3 BAND SWP RECEIVER

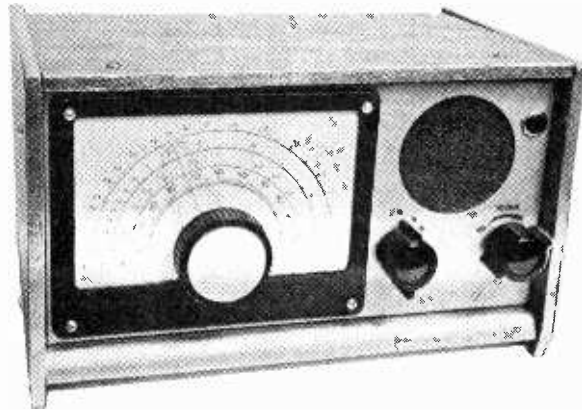

THIS receiver employs two transistors and two IC's, one of the latter in the intermediate frequency amplifier section and the second in the driver and output stages. It has band switching and covers all the important short wave ranges, including the low frequency bands, which are not included in some short wave or "all-wave" receivers.

The receiver has a very inexpensive but quite attractive cabinet and operates an internal loud-speaker, a jack allowing headphones to be plugged in when preferred.

MIXER STAGE

The mixer section is shown in Fig. 1 and uses six miniature coils, the appropriate coils being selected by the 3-way 6-pole rotary switch. Each range is separate from the others and two coils are in circuit for each range. L1, L2 and L3 are the aerial coils, and L4, L5 and L6 the oscillator coils.

The six poles of the switch are numbered from S1 to S6. Pole S1 takes the aerial circuit to the aerial coupling windings of the aerial coils and S2 transfers the aerial tuning section of the gang capacitor, VC1, to the correct coil, for aerial tuning purposes. Pole S3 connects the base of Tr1 to the base coupling windings, as necessary. The earthed ends of all aerial coupling windings (pin 9) and tuned windings (pin 1) are permanently connected to the chassis, while all the base coupling windings are returned to the base bias network R1/R2.

In a similar manner, switch section S4 selects the collector coupling windings of the oscillator coils L4, L5 or L6, while S5 connects the emitter of Tr1 to the appropriate emitter winding. S6 selects the tuned windings of the oscillator coils which are tuned by the second section of the ganged capacitor, VC2.

All the emitter windings (pin 7 of each coil) are returned to the emitter bias circuit, C2 and R3. In the same way, each collector winding (pin 8) goes to the IF amplifier.

In order to secure proper coverage and tracking, oscillator coil L5 has a padder capacitor: CP1 of 3000pF from pin 4 to chassis. L6 has a 1000pF capacitor CP2 from pin 3 to chassis while L4 requires no padder, pin 6 being wired to the chassis.

If the circuit in Fig. 1 appears difficult to follow, it is suggested that the switch is set at its middle position and L2 and L5 wired in. The receiver can then be tested on this band. When it is found to be in order L1 and L4 can be added and wired and a check made that this works correctly, before adding L3 and L6. This is much better than wiring in all the coils, then perhaps finding that a mistake has been made with the switch contacts or the operation of the switch, so that some wiring error is difficult to locate and correct. To avoid any possible confusion here, the bands, approximate coverage, and maker's range numbers are as follows:—

Band	Coverage	Maker's Range No.
A	30—10.5MHz 10— 28m	5T
B	15— 5 MHz 20— 60m	4T
C	5— 1.7MHz 60—180m	3T

L1 and L4 are for Band A, L2 and L5 for Band B and L3 and L6 for Band C.

In order to avoid squegging, or spurious oscillation and hissing spoiling reception, resistors R4, R5 and R6 are included in the individual collector circuits to L4, L5 and L6. The best values for these resistors depend on Tr1. Gain is maximum when these resistors are of the lowest values which allow proper working of this stage. The values shown should certainly be satisfactory, but it is an easy matter to have on hand a few resistors of various values between about 100Ω and 1kΩ (say about half a dozen different values) and try these in series with the circuit to pin 9 of each range, while tuning over the range. Excess oscillation is most likely at the high frequency end of any one band (VC2 nearly fully open).

Trimmers TC1, TC2 and TC3 are for aerial circuit trimming and each is adjusted on the appropriate band.

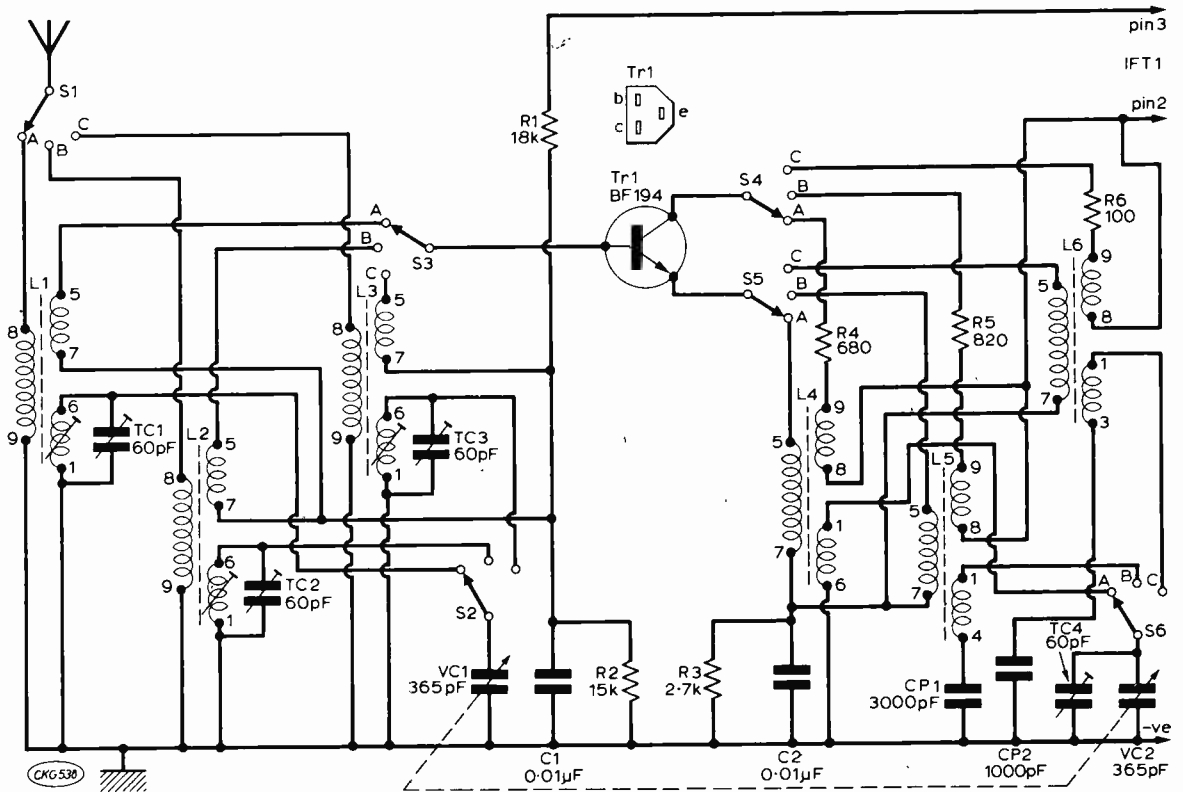
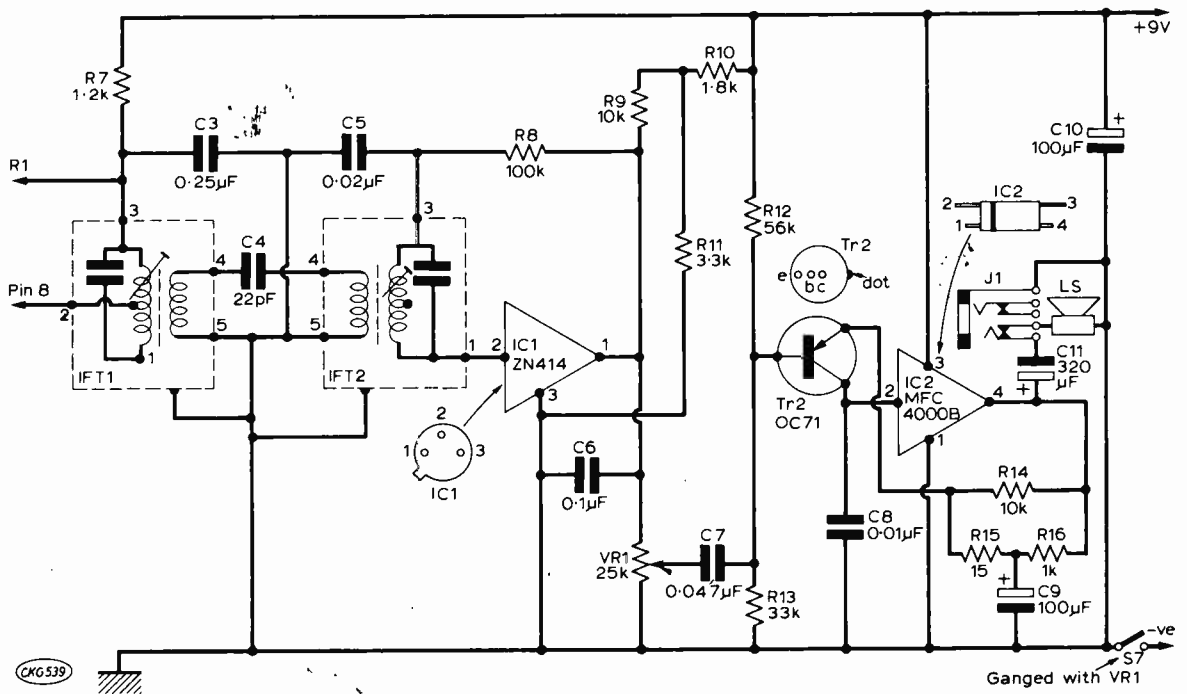

Fig. 1, above, and Fig. 2, below, give the complete circuit of the receiver.



IF AMPLIFIER

Fig. 2 is the circuit of the intermediate frequency amplifier and audio amplifier, which are constructed on one small circuit board. The IF filter consists of two loosely coupled units, IFT1 and IFT2, tuned to 470kHz.

Output from IFT2 goes to IC1 which provides three stages of amplification at 470kHz and includes automatic gain control and detection circuitry, giving an audio output which is taken to the volume control VR1.

Resistors R10 and R11 form a potential divider across the 9V supply and current is taken by IC1

and VR1 through R9. This means that the circuit should not be operated with VR1 disconnected and that this potentiometer should be of the value given.

The mixer stage is fed from its own positive supply point at the junction of C3 and R7.

AF AMPLIFIER

Tr2 is a high gain pre-amplifier, followed by IC2 which has 6 transistors and 3 diodes in a driver-push-pull output circuit which delivers approximately 250mW to a 16Ω speaker. This IC is very economical on battery current and the output is easily adequate for normal loudspeaker reception. The load impedance is not too critical, so that speakers of higher impedance may be used. R14, R15 and R16 provide direct current feedback to stabilise the whole audio amplifier.

CIRCUIT BOARDS

The mixer board is approximately 1¼ x 1¾in, Fig. 3, with a bracket fixed as shown and a tag serving as a return point for C1, C2, R2 and R3. This bracket must be bolted tightly to the metal chassis so that the board is connected to the negative line.

External connections will be required to a few points. These can be made by providing Veropins, or by leaving a projecting wire, so that leads can be soldered on as necessary.

The small pins of Tr1 project from the underside of the board and connecting wires are soldered directly to them which will run to the sections of the bandswitch, as indicated in Fig. 3.

Both sides of the IF/AF board are shown in Fig. 4 and it is approximately 3¾ x 1¼in. Holes should first be drilled to clear the pins and can tags of the two IF transformers. If any small error is made when drilling these, they can be enlarged or elongated as necessary with a very small round file. Drill holes for two 6BA bolts, one marked MC is fitted with a tag which forms the negative return

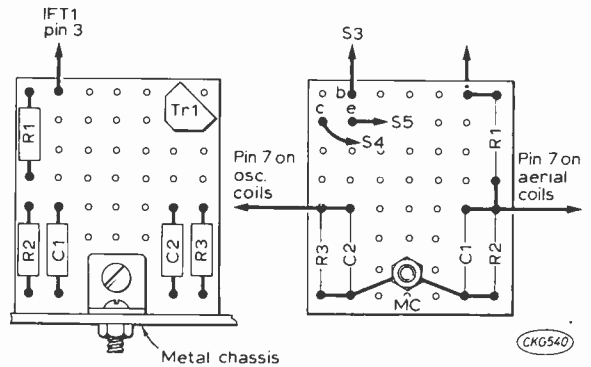

Fig. 3: Layout of components on the mixer board.

to the metal chassis. These bolts should be at least ½in. long so that spacers or extra nuts will allow the board to be clear of the metal chassis.

C4 is underneath, directly from pin 4 of IFT1 to pin 4 of IFT2, but all other items are on top of the board. Position these as shown, noting the polarity of electrolytic capacitors.

In most places the wire ends of the resistors and other items are long enough to reach the connecting points. Elsewhere, 24 s.w.g. tinned copper or similar connecting wire can be used. Sleeving is put on all leads which cross other wires and anywhere else where this appears necessary.

Two thin flexible leads are soldered on to connect to the speaker. A red flexible lead, with a positive battery clip, is also provided, as shown.

Colour coded leads also run from R9 and the base of Tr2. C7 is soldered directly on the centre tag of the volume control, VR1. Fit a colour-coded lead from C3, to run on to R1 on the mixer board. A further lead is taken from pin 2 of IFT1, up through the board as in Fig. 4, and will be soldered to the circuit which connects pins 8 on the oscillator coils.

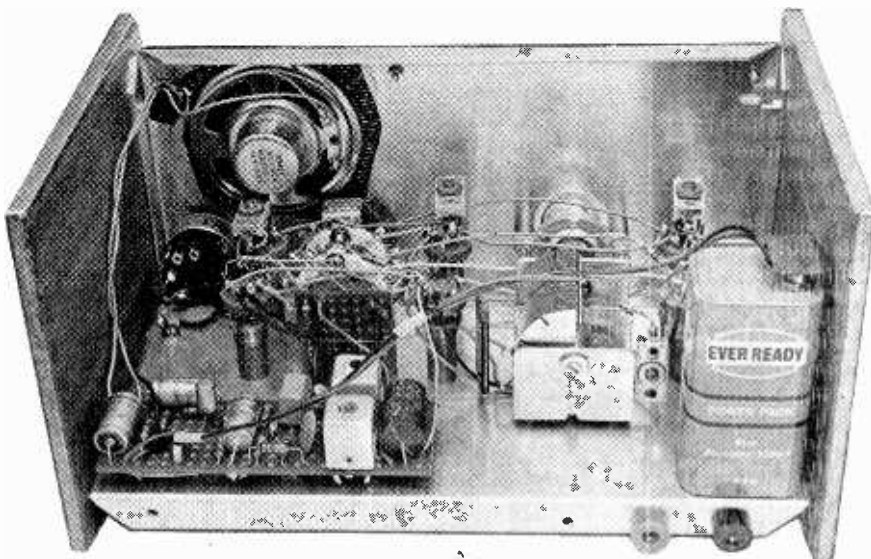

Rear view of receiver showing position of IF/AF board at front left with mixer board immediately behind.

★ components list

Resistors		
R1 18k Ω	R7 1.2k Ω	R13 33k Ω
R2 15k Ω	R8 100k Ω	R14 10k Ω
R3 2.7k Ω	R9 10k Ω	R15 15 Ω
R4 680 Ω *	R10 1.8k Ω	R16 1k Ω
R5 820 Ω *	R11 3.3k Ω	
R6 100 Ω *	R12 56k Ω	
		VR1 25k Ω log with switch, S7
Resistors \pm W 5%, * See text		
Capacitors		
C1 0.01 μ F	C9 100 μ F 10V	
C2 0.01 μ F	C10 100 μ F 10V	
C3 0.25 μ F	C11 320 μ F 10V	
C4 22pF	CP1 3000pF	
C5 0.02 μ F	CP2 1000pF	
C6 0.1 μ F	VC1/2 2 x 365pF (Jackson Type O. Cat. No. 5250/2)	
C7 0.047 μ F	TC1-4 60pF pre-set trimmers	
C8 0.01 μ F		
Semiconductors		
Tr1 BF194 IC1 ZN414	} S.C.S. Components POB 26, Wembley, Middx.)	
Tr2 OC71 IC2 MFC4000B		
Miscellaneous		
IFT1/2 (Denco IFT13). L1, Blue 5T. L2, Blue 4T. L3, Blue 3T. L4, Red 5T. L5, Red 4T. L6, Red 3T. (All Denco). Tuning drive (Jackson Type 6/36 Cat. No. 4103). S1-6, 2 wafer switch, each 3 pole 3 way. Speaker, 2 $\frac{1}{2}$ in, 25 to 40 Ω . Universal chassis mem- bers, 8 x 4in (2) (Home Radio). Switched output jack socket. Aerial and earth sockets. Veroboard 0.15in matrix, 1 $\frac{1}{2}$ x 1 $\frac{3}{4}$ in approx. and 3 $\frac{1}{2}$ x 1 $\frac{1}{2}$ in approx. Wood for cabinet. Knobs		

IC1 has three leads, positioned as in the under-side view of this component, in Fig. 4. IC2 has four spills, 2 and 3 being longer, as in Fig. 4. If this IC is located as shown, the tags will fit the Veroboard holes correctly and connections being soldered on underneath. Both ICs should be soldered without

undue heating. It should only be necessary to keep the soldering iron in contact with the joint for a second or two. Lengthy heating may damage these items.

This circuit board should not be tested without VR1 and the loudspeaker being connected.

If a signal generator is to be used to adjust the circuits, couple this loosely to the lead running to pin 2 of IFT1. It is only necessary to place the generator lead near this lead with no actual connection. The cores of IFT1 and IFT2 should then be adjusted, with a proper tool, for best output.

When no generator is available, adjustment should prove quite easy as the IFTs are pre-aligned by the maker. It is then only necessary to tune in a stable signal and adjust each core for best volume. The cores should have a sharp resonance peak. Again, it should be stressed that a properly shaped tool must be used, as a wedge-shaped blade may easily break the cores so that they cannot be rotated, while inserting a steel or similar screw-driver will upset correct alignment.

The audio section should be found to provide good amplification and adequate loudspeaker volume. The small internal speaker will give quite reasonable audio quality, for SW listening purposes. A larger, external speaker may be plugged in (as well as phones) and this will naturally give some improvement. It should be of suitable impedance, about 16 to 25 Ω . Though a small speaker can give satisfactory results, it cannot be expected to be quite as good as a larger unit operating with its own cabinet or baffle.

CONSTRUCTION

The chassis is a "universal chassis" flanged member 8 x 4in. with a second similar member used for the panel. The front edge of the chassis is set back $\frac{1}{2}$ in. from the panel, as in Fig. 5, using two $\frac{1}{2}$ in. spacers and two $\frac{3}{4}$ in. countersunk 6BA

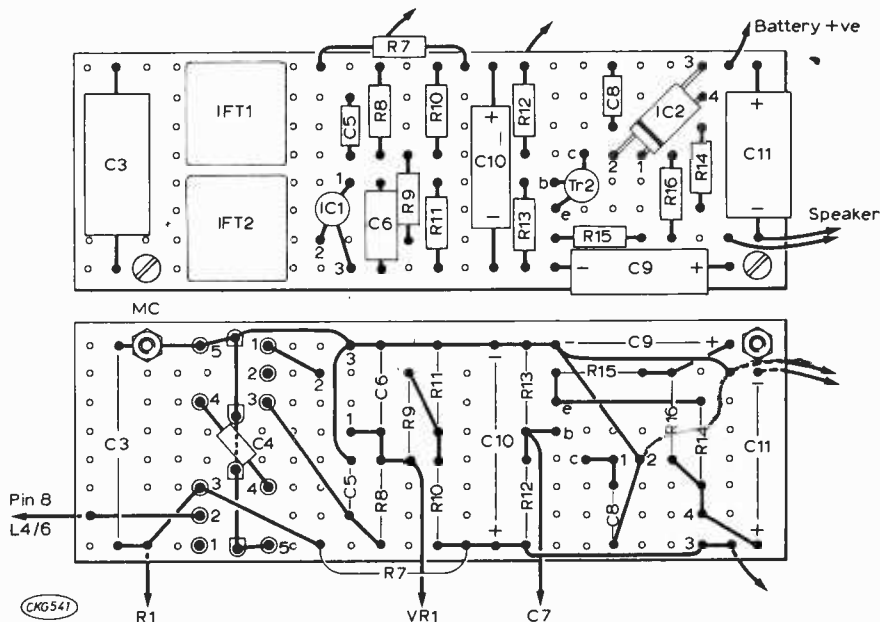

Fig. 4: The two sides of the IF/AF board and connections to the remainder of the circuit.

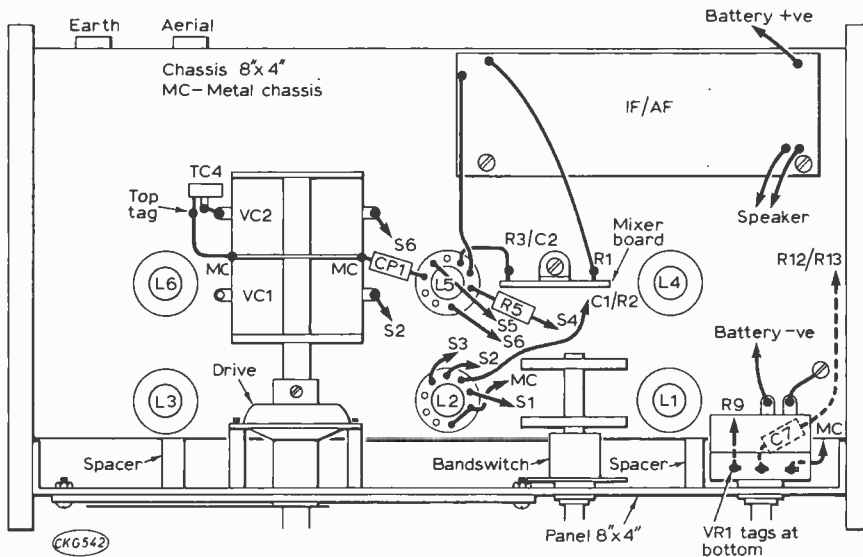

Fig. 5: Layout of major components on top of the chassis and interconnections.

bolts, which run through the panel and the front flange of the chassis. (These two bolts with spacers are not absolutely essential, as chassis and panel are held in position by the case sides. However, with the bolts securing these parts together, assembly and testing can be completed before fitting the sides in position, and wiring is thus more easily reached.)

Locate the drive template on the panel and drill the fixing holes for it and for the dual-speed ball drive. A large hole is also punched for the projecting part of the drive which carries the cursor.

Position the bandswitch and VR1 as in Fig. 5,

keeping these as low as possible to leave room for the speaker. The speaker opening is made with a large chassis punch or adjustable washer or tank cutter, or by drilling a ring of small holes and clearing up the edge with a half-round file.

Check that the panel and chassis are correctly fixed and at right angles, then fit the ganged capacitor into the drive and drill the fixing holes for the capacitor. Washers are placed under the capacitor to bring it level with the drive. The position of the drive and capacitor should be carefully adjusted as necessary so that they are in line and turn smoothly.

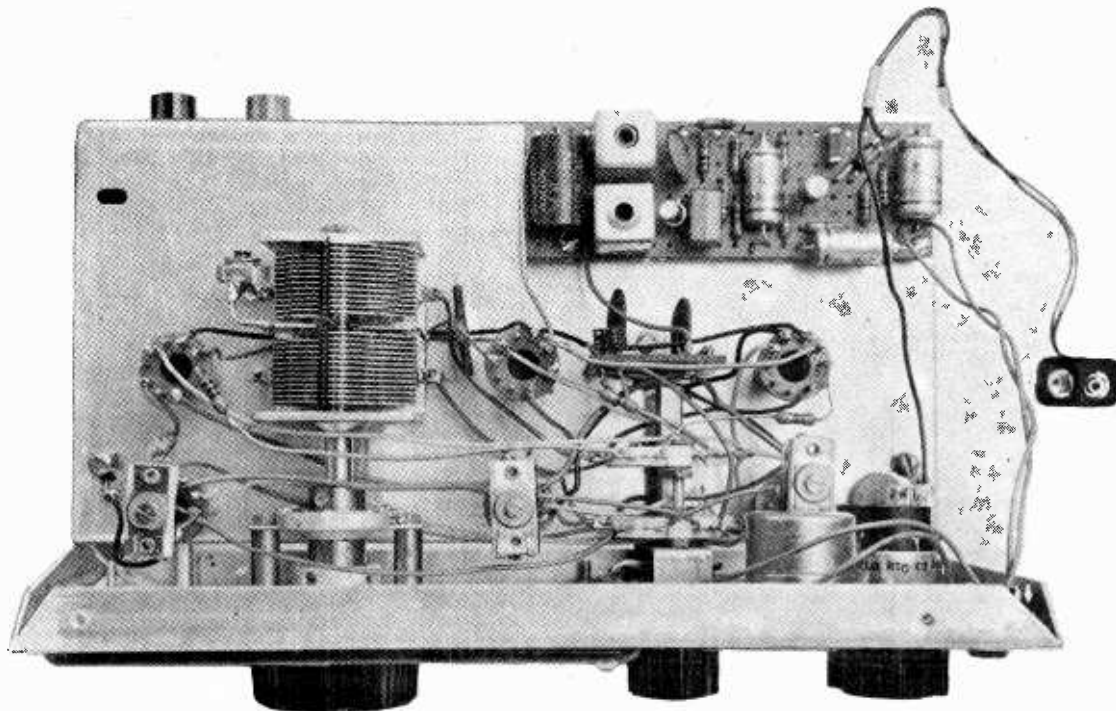

General view of receiver from above to assist in locating components shown in Fig. 5.

Holes $\frac{1}{4}$ in. in diameter are drilled for the six coils, which are located as in Fig. 5. Their fixing nuts should be tightened with the fingers only. Pins are counted in a clockwise direction from the space, from 1 to 9, and wiring is simplified if all the coils are positioned so that their pins are approximately in the same direction.

The IF/AF amplifier board and mixer board are fixed as in Fig. 5, but it is easier to leave these off until most of the wiring has been done to the lower tags of the switch, which are otherwise difficult to reach.

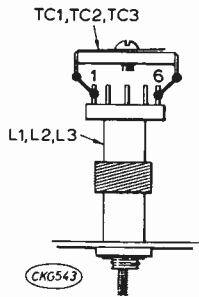

Fig. 6: Method of mounting trimmers on top of the coils.

Trimmers TC1, TC2 and TC3 are mounted directly across the coils L1, L2 and L3 as in Fig. 6. Short, stout wires are soldered to pins 1 and 6 of each coil, for this purpose, when wiring the receiver. It is preferable to take the upper plate tag of the trimmer to the earth side of the circuit (pin 1) in each case.

The single oscillator trimmer, TC4, is soldered to the ganged capacitor as in Fig. 5, the top tag being connected to the capacitor frame by a stout wire. A check should be made that the tuning capacitor fixing bolts are not too long, or they may touch the fixed plates of the capacitor.

A bandswitch with two wafers was used. The front wafer switches the aerial, base and VC1 circuits while the rear wafer is employed for the oscillator coils.

It is not essential to use a two-wafer switch provided the required number of poles are available and the switch is small enough to be accommodated.

Fig. 7 shows connections to the switch. It will be found very helpful to use colour-coded leads here. With the aerial coils, yellow may be used for aerial and S1 circuits, with red for base and S3 circuits, and green for S2, VC1 and associated circuits. For the back wafer, red can be used for S4, yellow for S5, and green for S6. Chassis returns to the coils can be black and the base bias circuit to C1/R2 may be blue. Whatever colours are used, employ them exclusively for one circuit.

It is also helpful to solder on lengths of wire, before mounting the switch, where the tags will be near the chassis, and hard to reach later. These wires can then be cut to length and taken to the various coils.

If the contacts of the switch cannot be seen, and its operation is not wholly clear, test it for continuity with a meter, in each position. Also it is advisable to wire in the coils for one band only, to confirm that no error is being introduced here, before proceeding with the other ranges.

Pressure should not be imposed on the coil pins when these are hot, so a little care is required when soldering these to prevent them moving when the insulation softens.

The volume control is mounted as in Fig. 5. Connect the lower tag to S7 and to the metal chassis. Run a lead from the other outer tag, under the chassis and up through a hole near the AF amplifier, where it is soldered to R9, Fig. 4. Solder C7 to VR1 slider and take a further insulated lead under the chassis and up through to the junction of R12 and R13.

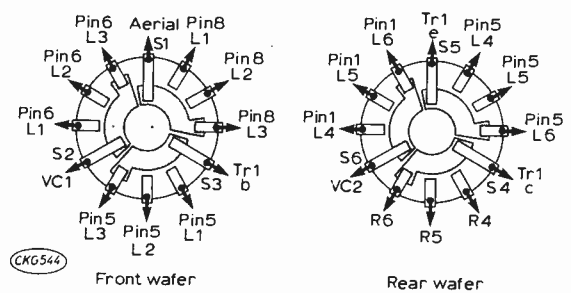

Fig. 7: Details of the wiring on the bandchange switch wafers.

ALIGNMENT

Alignment of the IFTs has been described. To align the aerial and oscillator coils, deal with one band at a time. Adjust the coil cores at a low frequency in the band (VC1/2 nearly closed) and the appropriate trimmer at a high frequency in the band (VC1/2 nearly open).

TC4 is initially set about half closed. If it is subsequently found that TC1, TC2 or TC3 is fully open for best volume, TC4 should be screwed down slightly. Provided TC1, TC2 and TC3 each have a definite peak giving best volume, there is no need for a separate trimmer for each oscillator coil.

Coverage is primarily determined by the settings of the oscillator coils and TC4. If a signal generator is available, set VC1/2 5° from the fully closed position and adjust the core of L4 for reception on 10.5MHz; similarly adjust L5 for reception on 5MHz, and L6 for reception on 1.67MHz.

L1 should then be adjusted at 11.5MHz for best volume. L2 is similarly adjusted at 5.5MHz, and L3 at 1.83MHz. VC1/2 is then opened to tune to 28.5MHz, and TC1 is adjusted. TC2 is adjusted at 13.5MHz, and TC3 at 4.5MHz.

These adjustments are repeated until no further improvement is possible. These frequencies are the most effective tracking points for the low frequency and high frequency end of each band and result in best tracking throughout the whole range.

CALIBRATION

The tuning drive listed has a scale marked 0-100°, in addition to scales for individual calibration. Set the cursor to 100° with the tuning capacitor fully closed. If calibrated as described the following points, read against the 0-100 scale, may be used as a guide to intermediate frequencies:—

Range A		Range B		Range C	
30MHz	12°	15MHz	7°	5.0MHz	8°
28MHz	15°	14MHz	10°	4.5MHz	12°
26MHz	17°	13MHz	13°	4.0MHz	17°
24MHz	19°	12MHz	16°	3.5MHz	22°
20MHz	27°	11MHz	19°	3.0MHz	29°
18MHz	32°	10MHz	23°	2.5MHz	41°
17MHz	36°	9MHz	28°	2.0MHz	62°
16MHz	40°	8MHz	35°	1.9MHz	70°
15MHz	45°	7MHz	44°	1.8MHz	79°
14MHz	52°	6MHz	59°	1.7MHz	89°
13MHz	60°	5.5MHz	71°		
12MHz	70°	5MHz	85°		
11MHz	81°				

CABINET

Each side of the cabinet is 6mm plywood, approximately 5¼in. deep, to give a front projection. The sides are 4½in. high at the back, and 5in. high at the front, to tilt the panel backwards slightly. (Note, however, that panel and chassis remain at right angles to each other.)

A strip of wood 8 x 1 x ½in. with a rounded front edge is fitted under the panel by means of two self-tapping screws run into the lower flange of the panel.

The cabinet top is 8 x 5¼in. and it is screwed to the back, which is 8 x 4in., by means of an inner strip about 8 x 1 x ½in. in size. This completed part (top and back) is secured with two self-tapping screws into the front flange, and two bolts at the back, so that it can be removed to renew the battery. The bottom of the chassis itself may be left open, or closed with a sheet of hardboard. ■

PW TECHNICROSS PUZZLE

Solution to No. 1
presented last month



TELEVISION

IN THE DECEMBER ISSUE

VISION MIXER

This easily built unit enables the outputs from two CCTV cameras—or more if extra channels are added—to be faded, switched or mixed. The unit produces a constant sync signal by taking the pulses from the "camera 1" channel and adding them to whichever video signal is selected.

ADDITIONAL I.F. AMPLIFICATION

There are several situations in which additional i.f. amplification can be useful. Simple transistor stages can also make it economically worth while. This article shows how.

SERVICING TV RECEIVERS

The next chassis to be dealt with is the GEC Series 1 single-standard chassis. We shall also be resuming the Philips G6 colour chassis.

DX RECEIVER SYSTEM

Following the recent article on varicap tuning units last month this article describes some receivers for DX operation.

COLOUR BRILLIANCE CONTROL

With the three c.r.t. drives necessary in a PAL colour receiver the traditional simple brightness control system is no longer suitable. An examination of the technique used instead provides a valuable insight into video circuit arrangements.

PLUS ALL THE REGULAR FEATURES

TO
(Name of Newsagent)

Please reserve/deliver the DECEMBER issue of TELEVISION (20p), and continue every month until further notice

NAME

ADDRESS

ambit international

Welcome to the company that really knows about the devices it supplies. Send 12p for our latest Datalogue & enquiry form details.

RADIO IC SELECTOR All compatible with TOKO filter blocks

TYPE No.	MODES	SENSITIVITY	FULL DATA	DEVICE	£
TAD 100	AM inc.det.	4uV for 9dB SN/N	23p	1-55	
TBA 651	ALL	1uV - 6dB - -	54p	2-00	
TBA120A	FM inc.det.	15uV-limiting begins-10.7MHz	23p	1-07	
CA 3088E	AM inc.det.	200uV for 20dB SN/N	16 p	1-50	
CA 3089E	FM inc.det.	12uV for 3dB limiting AFC-SQUELCH- AGC-TUNING METER DRIVER.	25p	2-20	

PLESSEY - NATIONAL-FAIRCHILD pro. communication ICs to order

TOKO BLOCK FILTER SELECTOR

TYPE	FREQUENCY	BANDWIDTH kHz	USAGE	PRICE
CFT 455 B	455 kHz	8 at -6dB ±10 at -22dB	nbfm	50p
CFT 455 C		6 27dB	am	50p
CFU 455 C		4-8 28dB	am	55p
MFH mechanical series		4,5 or 7 at -6dB ±5 at -50dB	ssb am nbfm	1-40
CFS 10-7	10.7 mHz	300 at -3dB 600 at -20dB	wbfm	40p
LPF 2016	low pass filter for STEREO radio (removes pilot tone) 2-00			

OTHER FILTERS & INDUCTORS AVAILABLE SEE DATALOGUE

block filters are **PREALIGNED**



RF POWER & OTHER SEMICONDUCTOR DEVICES A SELECTION FROM THE DATALOGUE RANGE

TRW-SET OF 4 transistors 30w rf out at 145 mHz. More out at lower frequencies. Set comprises of a TO5 pre-driver, two capstan power drivers & large capstan output stage. Limited offer £8-30 per set
 LM380 2w 12v/4w 20v. Only 2 extra components make the best AF amp IC available for £1-40
 40673 - 400mHz mosfet 57p; BF256 fet DC to 1000 mHz 37p; MJE340 43p; 40290-1-40; BC109-10p
 NE56- range of PLL; 561-3-50; 562-3-99; 567-2-60; timer 555-86p - new twin timer 555-2 £1-63
 FND 70 - 7seg LED display 1/2 X 1/4 inch, with integral filter. 2-20each or 4 for £8; data 5p
 9368 - MSI purpose built LED bcd decoder driver AND LATCH 2-20ea 4 - £8; 6 - 11-20
 DALO PCB pen 80p; U11 type NICAD £1-80 ea 10 for £17; LED panel light 26p; 7490 - only 63p

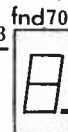

PW FERRET KITS - SAE for full details etc

When it comes to actually using linear ICs, RF power, etc., a lot of components sellers haven't got a clue. So if you get a problem with an application—well, that's just too bad. But at AMBIT we know about our products . . . try us and see.

Mail order centre: 37a High Street, BRENTWOOD, Essex, CM144RH Tel. 0277 216029
 All prices include VAT: Postage, etc. plus 10p per order please.

Another
winner!

fane MODE ONE HIGH FIDELITY LOUDSPEAKER KIT



Recommended
retail price

£10-98

including V.A.T.

Please
send S.A.E.
for fully
descriptive
leaflet.

Consisting of a Fane Model 803 ultra-low resonance 8" speaker unit with PVC cone surround, and a Fane Model 303 high frequency pressure tweeter together with a printed circuit cross-over assembly with ferrite cored coils.

SPECIFICATION OF UNITS

	Model 803	Model 303
Overall Diameter	8"	3"
Natural resonance	30Hz	—
Main resonance	*35Hz	1200Hz
Magnet Pole Diameter	1"	3/4"
Magnet Flux Density	13,000 gauss	10,000 gauss
Frequency response	30Hz-8kHz	2kHz-17kHz
Impedance	8-15 ohms	8-15 ohms
Power Handling	*15 watts	*15 watts

Very easy to assemble, this boxed kit comes with acoustic foam damping material, panels, screws, wire, wiring diagrams and instructions to provide a remarkable loudspeaker assembly—a pair is ideal for stereo.

CABINETS for the 'Mode One' are available in Teak veneer finish. SIZE 15½" x 10½" x 9".

*When used with above cabinet.

Distributors to the wholesale
and retail trade

LINEAR PRODUCTS LTD.

Electron Works, Armley, Leeds
LS12 3SA. Tel. 630126

Manufactured by

FANE ACOUSTICS LTD.

Hick Lane, Batley, Yorkshire.
Tel. Batley 6431



become a RADIO-AMATEUR!

learn how to become a radio-amateur
in contact with the whole world. We give
skilled preparation for the G.P.O. licence

free!

Brochure, without obligation to:

**BRITISH NATIONAL RADIO &
ELECTRONICS SCHOOL** P.O. Box 156, JERSEY

NAME: _____

ADDRESS: _____

WB123

BLOCK CAPS please

**SPECIAL 40 MHz SCOPE—
SOLARTRON CD1212 ONLY £50.**
Has to be a snag. There are no
plug-in Y amps available.

TB—100 nanoseconds per cm to 5 secs
per cm in 24 calibrated ranges. 20
nanoseconds per cm with times 5 expansion.
5in flat faced tube. Trace
locator. 0.2 microsec signal delay.
Built-in calibrator 1kHz square wave.
200 micro volts to 100 volts in 18
calibrated ranges. Tube sensitivity
3V/cm. Main Frame Y Amp boosts this
to better than 200 MV per cm at
40 MHz. 240V 50 Hz input. Complete
with full manual including plug-in
circuits. Come and see one working
or Carriage £1-50.

12" LONG PERSISTENCE CRT.
Full spec. Price £12-50 to include
V.A.T. and Carriage.

**MAKE YOUR SINGLE BEAM
SCOPE INTO A DOUBLE WITH
OUR NEW LOW PRICED SOLID
STATE SWITCH.** 2 Hz to 8 MHz.
Hook up a 9 volt battery and connect
to your scope and have two traces
for ONLY £5-50, P. & P. 25p. (Not
cased, not calibrated.)

**NEW WIDE RANGE WOBBU-
LATOR.** 5 MHz to 150 MHz up to
15 MHz sweep width. Only 3 controls,
preset RF level, sweep width and
frequency. Ideal for 10-7 or TV IF
alignment, filter receivers. Can be
used with any general purpose scope.
Full instructions supplied. Connect
6 3V A.C. and use within minutes
of receiving. All this for ONLY
£5-75, P. & P. 25p. (Not cased, not
calibrated.)

20 Hz to 200 kHz WB.

SINE and SQUARE GENERATOR.
Four ranges. Independent amplitude
controls, thermistor stabilised. Ready
to use, 9V supply required. £7-85
each, P. & P. 25p. (Not cased, not
calibrated.)

GRATICULES. 12cm x 14cm high
quality plastic 15p each, P. & P. 5p.

PLEASE ADD 10% V.A.T.

Open 9 a.m. to 6.30 p.m. any day.

CHILTEAD LTD
7/9 ARTHUR ROAD, READING, BERKS.
(rear Tech. College) Tel.: Reading 582605/65916

COMPONENT PACK consisting
of 5 pots, various, brand new; 250
resistors ½ and ¼ watt, many high
stabs, etc. Fine value at 50p, P. & P.
17p.

P.C.B. PACKS S & D. Quantity
2 sq ft—no tiny pieces. 50p plus
P. & P. 20p.

FIBRE GLASS as above £1 plus
P. & P. 20p.

5 CRYSTALS 70 to 90kHz. Our
choice. 25p, P. & P. 15p.

5 MOVING COIL METERS.
Various. £2, P. & P. 37p.

CAPACITOR PACK—50 Brand
new components, only 50p, P. & P.
17p.

POTS—10 different values. Brand
new. 30p, P. & P. 17p.

TRIMMER PACK. 2 Twin 50/200pF
ceramic 2 Twin 10/60pF ceramic;
2 min. strip with 4 preset 5/20pF
on each; 3 air spaced preset 30/100pF
on ceramic base. ALL BRAND NEW.
25p the lot, P. & P. 10p.

**FLAT FACED 4" TWIN BEAM
TUBE** type CV2193. Green trace.
Brand new £4 each, P. & P. 37p.

LIGHT EMITTING DIODES (Red)
from Hewlett-Packard. Brand New.
38p each. Holder 1p each. Informa-
tion 5p.

PHOTOCELL equ. OCP71, 13p each.

PHOTO RESISTOR type Clare 703.
Two for 50p.

MODERN TELEPHONES type 706.
Two-tone grey, £3-75 each. The same
but black, £2-75 each, P. & P. 25p
each.

Also **TOPAZ YELLOW** £4-50 each,
P. & P. 25p.

Ideal **EXTENSION TELEPHONES**
with standard GPO type dial, bell
and lead coding. £1-75 each, P. & P.
25p.

DELIVERED TO YOUR DOOR
1cwt of Electronic Scrap chassis,
boards, etc. No Rubbish. FOR
ONLY £3-50.

using
the



amplifier

J. B. DANCE M.Sc.

THERE are a number of integrated circuit audio power amplifiers available at the present time. One of these, the LM380N device, has a number of features which make it attractive to the amateur experimenter. In particular, it is very useful in circuits requiring the minimum number of components. The device is manufactured by the National Semiconductor Company, and is available from Ambit International, 37 High Street, Brentwood, Essex, or Athena Ltd., 140 High Street, Egham, Surrey.

ADVANTAGES

The LM380N automatically 'centres' its output at one half of the power supply voltage. This eliminates the need for additional circuitry (including a pre-set potentiometer) which is required with some other types of amplifier for adjusting the bias so that maximum voltage swing (and hence a maximum power output) can be obtained.

The LM380N device also incorporates internal protective circuits. If the silicon chip becomes too hot (above about 150°C) owing to incorrect operation, the circuit automatically becomes inoperative for a time until the chip has cooled. Protection is also incorporated against excessive current in the output stage; such currents will occur if the output is accidentally short-circuited. The limiting current in the output stages is about 1.3A.

The LM380N can feed up to 2.5W to an 8Ω loudspeaker when operated from an 18V supply. The absolute maximum permissible supply voltage is 22V, but it is wise to use a somewhat lower value to allow a margin for error. The writer has found that satisfactory loudspeaker volume can be obtained using the minimum recommended supply voltage of 8V. The total harmonic distortion is 0.2% at 2W output using an 18V supply.

It is normally convenient to use the LM380N in a standard 14 pin dual-in-line socket so that it can

be removed easily from the circuit. However, one can solder directly to the terminals of the device.

CONNECTIONS

The connections of the LM380N are shown in Fig. 1. The input signal can be fed either to the non-inverting input or to the inverting input. Generally it is more convenient to feed the signal to the non-inverting input and to leave the inverting input unconnected.

If, however, the signal is fed to the inverting input, the non-inverting input should be returned to earth through a capacitor or a resistor or directly earthed. This will prevent positive feedback from the output to the non-inverting input causing instability. A capacitor is preferable when the signal source has a high impedance, but with a source of moderate impedance a resistor approximately equal in value to this source impedance is preferable to maintain the balance of the differential stage. When the source impedance is low, the non-inverting input may be earthed.

GAIN

The voltage gain of the LM380N is fixed at 50 (or 34dB) by the internal circuitry of the device. Although this fixed gain limits the versatility of the amplifier, it does result in a minimum number of external components being required for its use.

HEAT SINK

The LM380N device itself can dissipate up to 1.25W when operated without any heat sink at ambient temperatures of up to 25°C; this is adequate for many applications. For example, Fig. 2 shows that the power does not exceed 1.25W at supply voltages up to 14V when an 8Ω speaker is employed. Even if a higher supply voltage is used, it is not likely that the dissipation will exceed 1.25W for an appreciable time.

Fig. 3 shows that there is still less chance of overheating when a 16Ω speaker is employed. In this case, the supply voltage would have to exceed 20V for the dissipation to exceed 1.25W.

In the case of a 4Ω speaker, however, Fig. 4 shows that the dissipation can reach 1.25W when a 10V supply is used. If a much higher supply voltage is employed, the pins 3, 4, 5, 10, 11 and 12 of the device should be soldered to a copper heat sink of

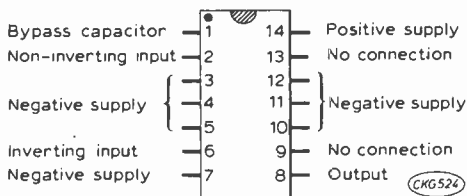
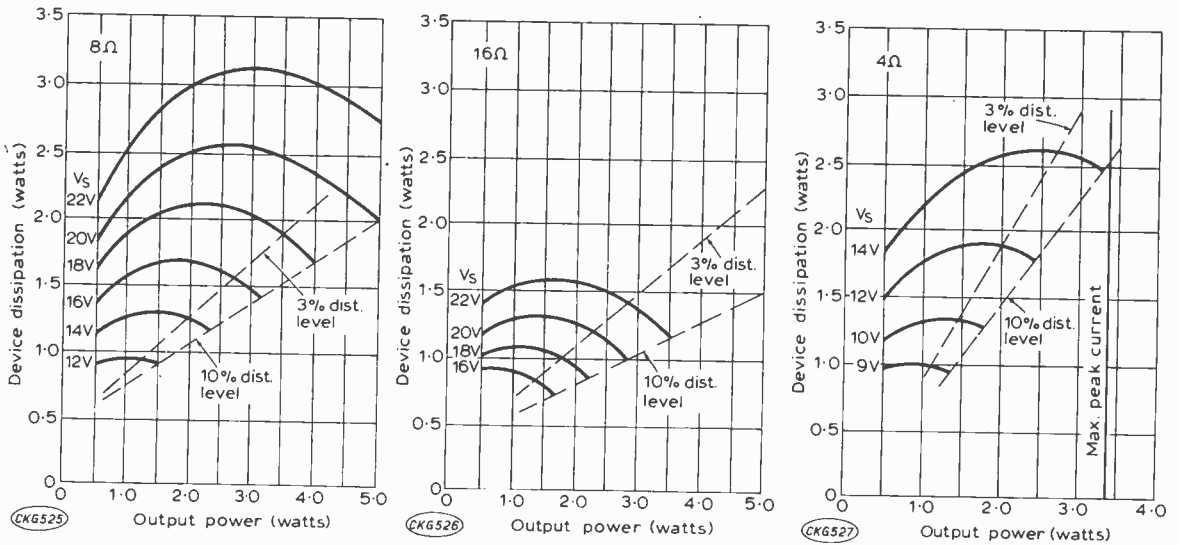

Fig. 1:



Figs. 2, 3 and 4: These graphs show dissipation of the LM380N against output power for various values of supply voltage and loudspeaker impedance

area about six square inches.

The three per cent total harmonic distortion line shown in Figs. 2 to 4 is approximately the onset of clipping.

POWER SUPPLY

If there is hum or noise on the power supply line, a hum rejection of about 38dB can be obtained by connecting a $5\mu\text{F}$ capacitor from pin 1 to earth. A smaller capacitor will also provide some measure of hum reduction.

If the power supply leads from a battery or filter capacitor are longer than two or three inches, a $0.1\mu\text{F}$ capacitor should be connected between pin 8 and earth to prevent oscillation.

In addition, a 2.7Ω resistor in series with a $0.1\mu\text{F}$ capacitor may be connected between pin 8 and earth to suppress any high frequency oscillations.

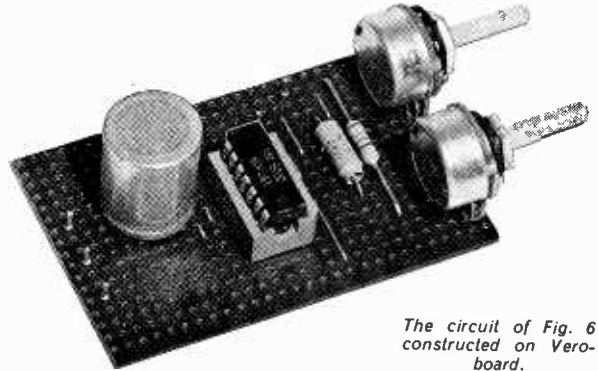

The circuit of Fig. 6 constructed on Vero-board.

The input pin operates with a mean potential equal to the earth potential. A capacitor in series with the input pin is therefore required only if the

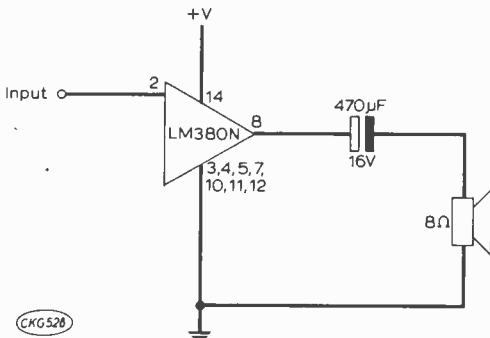

Fig. 5: A simple circuit using the LM380N.

SIMPLE CIRCUIT

The simplest circuit using the LM380N is shown in Fig. 5. The $470\mu\text{F}$ capacitor must be placed in series with the loudspeaker to prevent a steady current from flowing through the speaker from pin 8. A smaller capacitor than that shown will result in inferior bass response.

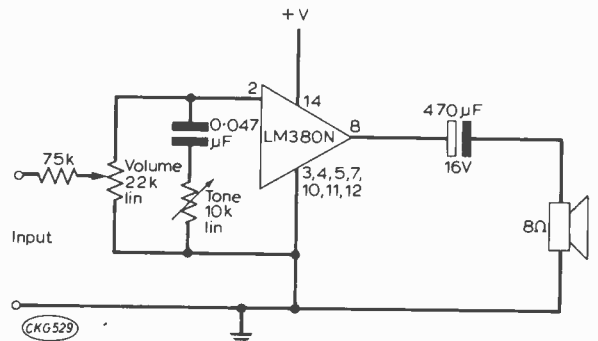

Fig. 6: A record player amplifier suitable for use with a crystal or ceramic pick-up cartridge.

mean potential of the signal source is not also at earth potential.

The writer has used the circuit of Fig. 5 in a radio receiver. Fig. 6 shows how a similar circuit may be used as a record player amplifier with volume and tone controls. The input impedance of the LM380N is about $150\text{k}\Omega$.

LARGE STOCKS ATTRACTIVE DISCOUNTS DEPENDABLE SERVICE

Everything brand new & to makers specs.

ELECTROVALUE Electronic Component Specialists

TRANSISTORS BY SIEMENS AND NEWMARKET

2N3055 npn silicon power 60p
 AC163K pnp germanium low power 32p
 AC176K npa germanium low power 32p
 AD161 npa germanium medium power 42p
 AD162 pnp germanium medium power 40p
 AF139 pnp germanium UHF 49p
 BC 107 13p; BC108 12p; BC109 13p; } npn
 BC167 11p; BC168 10p; BC169 11p }
 BC177 21p; BC178 19p; BC179 21p } pnp
 BC267 12p; BC268 11p; BC269 13p }
 Standard groupings available.
 BD135 npa med power 37p
 BD136 pnp med power 38p
DIODES
 OA90, OA91, OA96 each 6p
 OA200 9p; OA202 10p
 Other semiconductor
 AC128 17p; AF117 32p
 BFY61 19p

Full lists and technical data will be found in Catalogue No. 6. See also amendments list.

SIEMENS' THYRISTORS

0.8A 400V 56p, 600V 70p
 3A 400V 60p, 600V 85p

ZENER DIODES full range E24 values: 400mW: 2.7V to 36V, 14p each; 1W: 6.8V to 80V, 21p each; 1.5W: 4.7V to 75V, 45p each. Clip to increase 1.5W rating to 3 watts (type 266F) 4p.

DIN PLUGS & SOCKETS

by Hirschmann, 4A rating

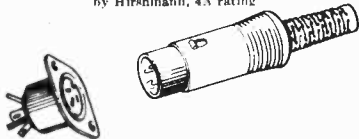

2 way LS—socket 10p; plug 12p. 3 way scr. socket 10p; plug 12p. 5 way scr. socket 12p; plug 15p.

TRANSISTOR ACCESSORIES

To3 cover 7p
 Heat sinks 1°C/w, type 6W1, undrilled 60p

SWITCHES

1011C SP8T toggle 20p
 409 DPDT toggle 29p. (These are chrome plated 2.5A rating)
 7201 Sub-miniature DPDT 250V a.c./2A 48p

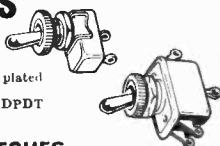

ROTARY SWITCHES

Radiospare Miniature Maka-switch (in assembly kit form) Shaft 45p
 Wafers, 3MB-2P5W, 1P11W; DBM-1P12W, 2P6W, 3P4W, 4P3W, 6P2W, each, 6p.

WAVECHANGE SWITCHES

1P12W, 2P6W, 3P4W, 4P3W, each 24p



ELECTROLYTIC CAPACITORS

AXIAL LEAD Prices subject to amendment by the manufacturer.

Rated voltage: 3V 6.3V 10V 16V 25V 40V 63V 100V

Capacity μ F	3V	6.3V	10V	16V	25V	40V	63V	100V
0.47								7p
1.0					10p			7p
2.2					10p			8p
4.7				10p		7p		8p
10					7p	8p		9p
22					7p	8p		9p
47	7p				8p	7p		9p
100	8p	7p	7p	7p	7p	9p		11p
220	7p	8p	8p	8p	9p	10p		17p
470	8p	9p	9p	10p	12p	17p		24p
1000	10p	12p	12p	17p	20p	24p		40p
2200	14p	17p	22p	25p	38p			
4700	25p	28p	37p	41p	54p			
10,000	40p	45p						

Polycarbonate -5% Tolerance

250V up to 0.1 μ F: 100V/0.1 μ F and above.
 0.01; 0.012; 0.015; 0.018; 0.022; 0.027; 0.033; 0.047; 0.056; each 4p.
 0.068; 0.082; 0.1; 0.12; 0.15 each 4p.
 0.18; .22; each 5p.
 0.27; 0.33; 6p. 0.39 7p. 0.47 8p. 0.56 10p.
 0.68 11p. 1 μ F 13p.
 Prices subject to amendment by the manufacturer.

SILVERED MICA non-polarised capacitors in 34 values from 2.2 pF to 680 pF, each 6p

RESISTORS 10%, 5%, 2%

Code	Power	Tolerances	Range	Values available	1 to 9	10 to 99	100 wip
C	1/20W	5%	82 Ω -220K Ω	E12	9	3	7.5
U	1/8W	5%	4.7 Ω -470K Ω	E24	1	0.9	0.75 nett
C	1/4W	5%	4.7 Ω -10M Ω	E12	1	0.9	0.75 nett
C	1/2W	5%	4.7 Ω -10M Ω	E24	1.2	1	0.9 nett
C	1W	5%	4.7 Ω -10M Ω	E12	2.5	2	1.6 nett
MO	1/2W	2%	10 Ω -1M Ω	E24	4	3	2 nett
WW	1W	10% \pm 1/20 Ω	0.22 Ω -3.9 Ω	E12	7	7	6
WW	3W	5%	1 Ω -10K Ω	E12	7	7	6
WW	7W	5%	1 Ω -10K Ω	E12	9	9	8

Codes: C—carbon film, high stability, low noise.
 MO—metal oxide, Electrofil TR5, ultra low noise.
 WW—wire wound, Pleseccy.

Values:
 E12 denotes series: 10, 12, 15, 18, 22, 27, 33, 39, 47, 56, 68, 82 and their decades.
 E24 denotes series: as E12 plus 11, 13, 16, 20, 24, 30, 36, 43, 51, 62, 75, 91 and their decades.

Prices are in pence each for quantities of the same ohmic value and power rating. NOT mixed values. (Ignore fractions of one penny on total value of resistor order).

★ Please remember to add V.A.T. to your order.

If you have already got your No. 6 catalogue and want to know latest additional items and price amendments, send S.A.E. for special supplementary list.

KNOBBS

All grub screw fitting for 1/8" shafts. Black. For other types—see Catalogue No. 6, P.54

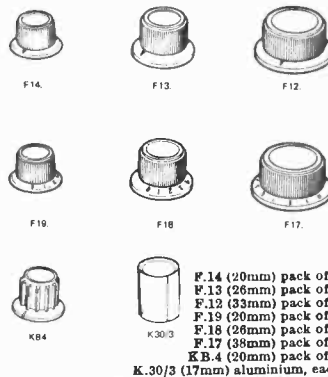

F.14 (20mm) pack of 2 38p
 F.13 (26mm) pack of 2 38p
 F.12 (33mm) pack of 2 40p
 F.19 (20mm) pack of 2 32p
 F.18 (26mm) pack of 2 38p
 F.17 (38mm) pack of 2 40p
 K.B.4 (20mm) pack of 4 40p
 K.30/3 (17mm) aluminium, each 24p

POTENTIOMETERS

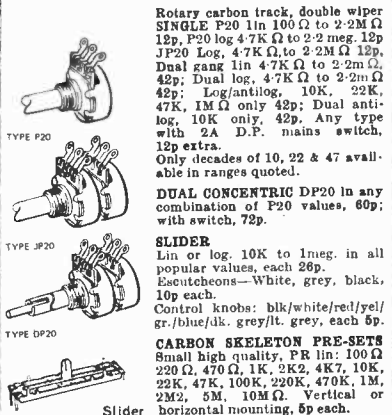

Rotary carbon track, double wiper SINGLE P20 1in 100 Ω to 2.2M Ω 12p, P20 log 4.7K Ω to 2.2 meg. 12p JP20 Log, 4.7K Ω to 2.2M Ω 12p, Dual gang 1in 4.7K Ω to 2.2M Ω 42p, Dual log, 4.7K Ω to 2.2M Ω 42p, Log/antilog, 10K, 22K, 47K, 1M Ω only 42p; Dual antilog, 10K only 42p. Any type with 2A D.P. mains switch, 12p extra.
 Only decades of 10, 22 & 47 available in ranges quoted.
DUAL CONCENTRIC DP20 in any combination of P20 values, 60p; with switch, 72p.
SLIDER Lin or log, 10K to 1meg. in all popular values, each 26p. Escutcheons—White, grey, black, 10p each.
 Control knobs: blk/white/red/yl/gr./blue/blk. grey/lt. grey, each 5p.
CARBON SKELETON PRE-SETS Small high quality, PR lin: 100 Ω 220 Ω , 470 Ω , 1K, 2K2, 4K7, 10K, 22K, 47K, 100K, 220K, 470K, 1M, 2M, 5M, 10M Ω . Vertical or horizontal mounting, 5p each.

All items offered for sale in accordance with our stated terms of business, copy of which available on request. Prices quoted DO NOT include V.A.T. Orders from U.K. customers must be accompanied by an additional 10% of net value for V.A.T.

DISCOUNTS Not allowed on net price items. 10% on orders for £5 or more, 15% on orders for £15 or more. Prices subject to alteration without prior notice. PLEASE SEE LATEST AMENDMENT LIST. SEND S.A.E.

POSTAGE AND PACKING FREE SURCHARGE 10p on small mail orders under £2. Overseas orders carriage and insurance charged at cost.

IT'S ALL IN THE LATEST ELECTROVALUE CATALOGUE

No. 6 (4th printing) contains details of 100's of semi-conductors; ICs with circuit diagrams, R's and C's of practically every kind, accessories, components, tools, materials, etc. information and equivalent tables, etc. Well illustrated (96 pages 5 1/2" x 8 1/2") 25p. post free with refund voucher for 25p. available on orders over £5 or more.

with
25p
refund
voucher

ELECTROVALUE

(Dept. P.W. 8) 28 ST. JUDES ROAD., ENGLEFIELD GREEN, EGHAM, SURREY, TW20 0HB
 Hours: 9—5.30: Sat. 1 p.m. Tel.: Egham 3603 Telex 264475

ENG. REG. NO. 1047768. R.O. 28 ST. JUDES ROAD, ENGLEFIELD GREEN, EGHAM, SURREY, TW20 0HB

BIG Discounts

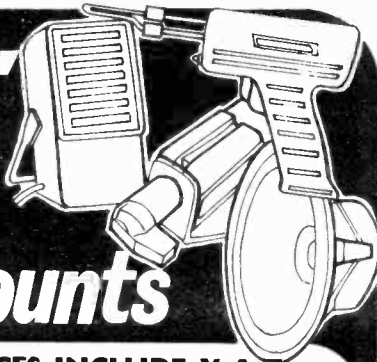

ALL PRICES INCLUDE V.A.T.

SPEAKER BARGAINS		£			£			
EMI 13" x 8" 3, 8 or 15 ohm			ELAC 8" Solim Dualcone		2 10			
Plain	2 05		FANE 7" x 4" 3 or 8 ohm		1 00			
With Co-Axial Tweeter	2 20		8" Dualcone 8 ohm		2 40			
Twin Tweeter	3 55		CELESTION 8" 15 ohm		1 55			
Type 350 8 ohm, 20 watt	8 00		ADASTRA 10" 8 or 15 ohm,					
8" 8 ohm, 10 watt	2 70		10 watt		2 75			
8" 8 ohm, 10 watt	3 75		BAKER GROUP 25 12" 8 or					
12" 8 ohm, 20 watt	5 50		15 ohm, 25 watt		6 45			
8" x 5" C/Mag. 5 watt	1 20			P. & P.	25			
8" x 5" Dualcone			5" 8 ohm, 5 watt C/Mag.		85			
8 ohm, 10 watt	2 45		2 1/2" 8 ohm or 64 ohm		50			
GOODMANS 6 1/2" 8 ohm				P. & P.	10			
Dualcone	1 60							
TWEETER & CROSSOVER								
EMI 3 1/2" 3 or 8 ohm C/Mag.	1 00		Dome Tweeter 8 ohm, 30 watt		4 00			
Cone Tweeter 8 or 15 ohm,			Crossovers CN23 (3 ohm),					
10 watt	1 90		CN28 (8 ohm), CN216 (16					
Cone Tweeter 8 ohm, 3 watt	1 00		ohm)		1 00			
Horn Tweeter 8 ohm, 20 watt	3 50			P. & P.	10			
KIT FORM CABINETS TEAK VENEER								
12 x 12 x 6 with 8" 8" x 5" or			18 x 11 x 9 with 13" x 8" cutout		4 25			
6 1/2" and 3 1/2" cut out.	2 45		for EMI 350					
17 x 10 x 6 with 8" or 13" x 8"				P. & P. ea.	35			
cutout	3 25							
MICROPHONES								
CM20 Crystal Hand	50		TW206		5 75			
CM70 Planet stick metal,			CONDENSER MIKE 600 ohm,		7 90			
switch crystal	1 55		unl-dir					
DM160 Dynamic uni-dir, ball			Cassette Stick Mike with R.					
metal	3 95		Control on/off switch		1 35			
UD130 50K/600 ohm, unl-dir			(2-5 & 3-5mm J/Ply)		15			
ball metal	4 50			P. & P.				
SOLDERING IRONS								
ANTEX CN240 15 watt	1 60		X25 25 watt (low		1 60			
SK 1 Kit (15 watt iron			leakage)					
2 spare Bib etc.)	2 65			P. & P.	10			
CARTRIDGES								
ACOS GP91/2SC or GP91/3SC			19-TI Stereo crystal		80			
Stereo comp.	1 00		BSR SC5M Stereo ceramic		2 25			
GP83/1 Stereo crys.	1 35		SX5H Stereo crystal		1 60			
GP94/1 Stereo crys.	1 75		SX5M Stereo crystal		1 60			
GP95/1	1 35		X5H Mono/stereo		1 25			
GP96/1	1 75		X5M Mono/stereo		1 25			
GP101	75		GOLDRING G800 G850 £3.85 £2.95					
SONOTONE			STYLI for above cartridges		1 25			
0THAC Stereo cer. diam.	1 80		Sapphire 35 D. Diamond		1 95			
			GOLDRING G800 G850		1 95			
				P. & P.	85			
BATTERY ELIMINATORS								
240v Input 6, 7.5 or 9 300mA	2 20		lighter socket) 6, 7.5 or 9		2 20			
12v d.c. input (fits in car			d.c. output at 300mA					
				P. & P.	10			
TAPES		Std	LP	DP	7"	Std.	LP	DP
5"	45p	55p	70p		65p	95p	110p	
5 1/2"	55p	65p	95p					
					P. & P. 1-3, 9p ea. 4 or more, lot 30p			
LOW NOISE CASSETTES								
C60	1-5	6-10	11-20		Cassette Head Cleaner	35p		
C90	35p	33p	30p		P. & P. 1-5, 3p ea. 6-10, 15p lot			
C120	45p	43p	40p		11-20, Post Free.			
	55p	52p	50p					
PLASTIC LIBRARY CASES								
For 5"	Reels				CASSETTE CASES	10p		
5 1/2"	Reels	18p			P. & P. 1-3, 5p ea. 4 or more, 20p			
7"	Reels	22p						
		25p						
BIB ACCESSORIES								
Tape Editing Kit	Ref. 23	1 30	SPECIAL OFFER BUSH Stereo System with indep. Vol., Bass & Treble controls on each Speaker for optimum reprod. Using Garrard 2025TC Auto Change Deck in deluxe teak plinth and cover. Today's Value £49.50. OUR PRICE £27.50 + £1.50 P. & P. 12 months Guarantee by Maker. THIS IS A BARGAIN NOT TO BE MISSED!					
Recording Tape	Ref. 20	1 15						
Splicer	Ref. 20	1 15						
Cassette Tape, editing	Ref. 24	1 40						
Cassette Salvage Kit	Ref. 25	40p						
12's Cassette Case	Ref. 34	£1.00						
Stylus Balance	Ref. 32A	1 15						
Spirit Lever	Ref. 46	50						
Hi-Fi Stereo Test Cassette	Ref. 46	1 90						
Groove-Kleen Record Cleaner	Ref. 46	1 90						

Send 25p for COMPLETE CATALOGUE, refundable upon first order. ALL OUR MERCHANDISE IS FULLY GUARANTEED

Riversdale Electronics

Mail Order Department PW12

P.O. Box 470, Manchester M60 4BU.

Parts for PRACTICAL WIRELESS and PRACTICAL ELECTRONICS PRODUCTS

ALL PARTS AVAILABLE SEPARATELY "p.e." f.m. varicap stereo tuner



Approx Size - 8 1/2" x 2 1/2" x 6 1/2"

Total Kit price only £28.50 including VAT and postage. Please send large S.A.E. for full details.

P. E. 'GEMINI' STEREO AMPLIFIER

30 Watts (R.M.S. per Channel into 8 Ohms !!)
 Total Harmonic Distortion 0.02% !!
 Frequency Response (-3 dB) 20Hz-100kHz !!

This high quality Stereo Amplifier for the Home Constructor was described in a series of articles in "Practical Electronics", from November 1970 to March 1971. It is recognised as practically the ultimate in High Fidelity and is certainly equal to anything one can buy, no matter what the cost, but it is well within the capabilities of the ambitious constructor.

We can now supply a reprint of the articles in booklet form, price 64p., including VAT and postage, with free complete component price list.

For free price list only, or a complete free specification, please send a foolscap size S.A.E.

ELECTRO SPARES

288, Ecclesall Road
 Sheffield, S11 8PE
 Tel. Sheffield (0742) 668888



The Component Centre of the North

NEW! FOR RTTY ENTHUSIASTS

THE TELEPRINTER HANDBOOK

by D. J. Goacher, G3LLX, and J. G. Denny, G3NTT

The new RSGB *Teleprinter Handbook* covers all aspects of radioteleprinter (rtty) operation, equipment and techniques with particular reference to the interests of amateurs. For the experienced operator it provides, in one volume, all the accumulated information acquired during the past decade, and covers machines of both European and USA origins; for the intending enthusiast it includes all the basic information necessary to master the techniques of rtty operation.

The contents include: theory, practice and standards; teleprinters; associated rtty machines; power supplies; terminal units; auxiliary equipment; frequency shift keying; filters; test equipment; interconnection and control of rtty equipment; operating procedures; glossary; bibliography.

376 pages and hundreds of illustrations and diagrams.

The **TELEPRINTER HANDBOOK** is available, price £5.35 post free, direct from:

RADIO SOCIETY OF GREAT BRITAIN
 35 Doughty Street, London WC1N 2AE

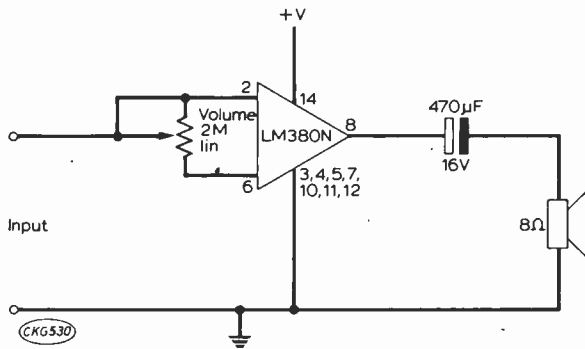

Fig. 7: A high input impedance achieved by use of a common-mode volume control.

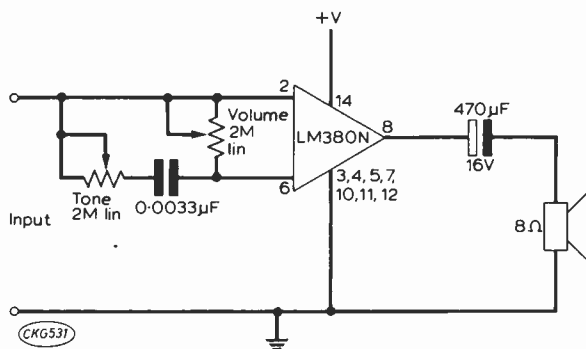

Fig. 8: This circuit features common-mode controls for both volume and tone.

HIGH IMPEDANCE INPUT CIRCUIT

An amplifier with a high impedance input is shown in Fig. 7; it is suitable for use with high impedance signal sources such as a crystal microphone. This circuit employs a 'common mode' volume control. When the potentiometer slider is at the bottom of its travel in Fig. 7, the input signal is fed to both the inverting and the non-inverting inputs. In this case the signals will almost cancel in the device and the output will be small. When the potentiometer is at the top of its travel, however, only pin 2 will receive an appreciable input voltage and maximum volume will be obtained.

The circuit of Fig. 8 shows how a common mode volume control circuit may be used with a common mode tone control to maintain the high input impedance.

A very high input impedance amplifier can be made using the field-effect transistor input circuit shown in Fig. 9. At low frequencies the input impedance is 22 megohms, but at high frequencies the input impedance is reduced by the gate to drain capacitance of the field effect transistor

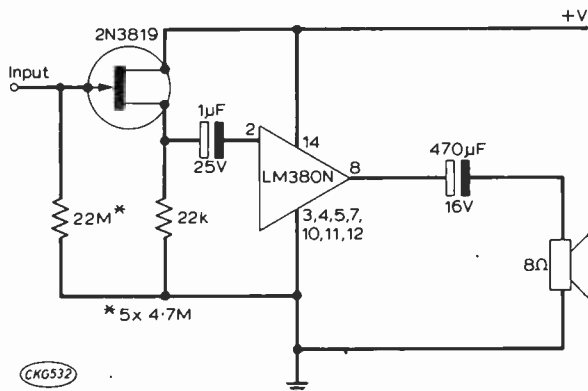

Fig. 9: The addition of a FET input stage gives a very high input impedance.

INTERCOM SYSTEM

A simple circuit for an intercom system is shown in Fig. 10. The transformer ratio of 25:1 multiplied by the gain of the LM380N produces a loop gain of 1250. The roles of the input and output speech transducers are reversed when the switch is operated.

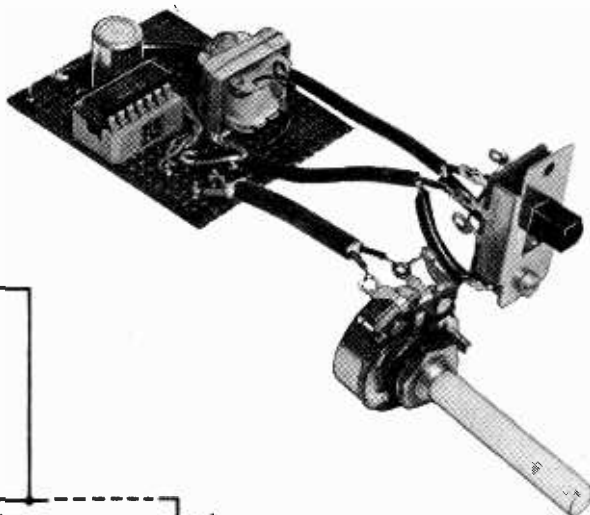
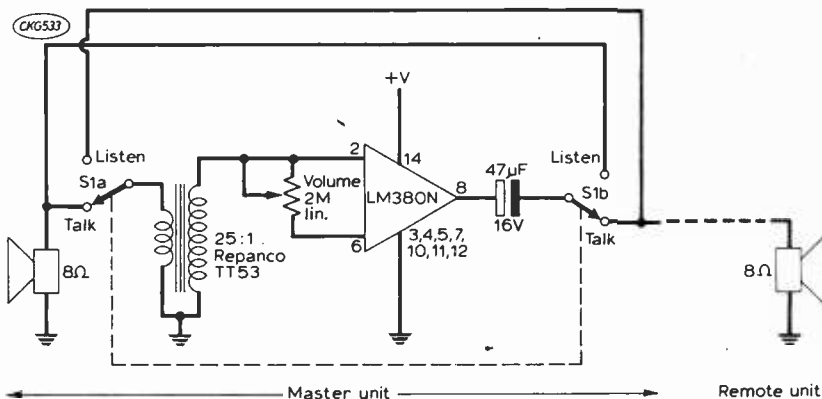

Fig. 10: An intercom system in which the loudspeakers double as microphones. The view above shows the amplifier with controls attached.

DUAL POWER SUPPLY

Another simple circuit using the LM380N is shown in Fig. 11; it provides a dual voltage supply balanced with respect to ground from a single supply. If the input is 20V, outputs of +10V and -10V can be obtained. The potentiometer can be used to balance the outputs relative to ground, but may be omitted if exact balance is not required.

An advantage of this circuit is that a high quiescent current is not taken when little current flows in the outputs.

EXTRA GAIN

Although the gain of the LM380N is fixed at 50 by the internal components, higher gain can be obtained by using additional positive feedback. For example, Fig. 12 shows how a gain of 200 can be obtained.

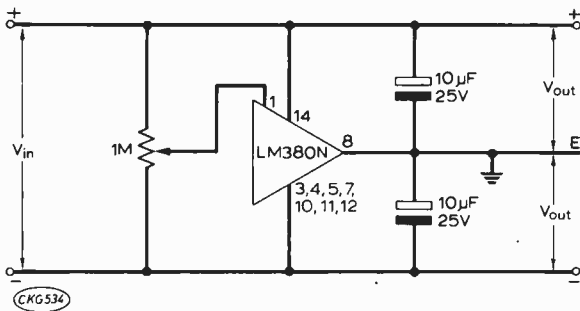

Fig. 11: A circuit to provide a split power supply from a single source.

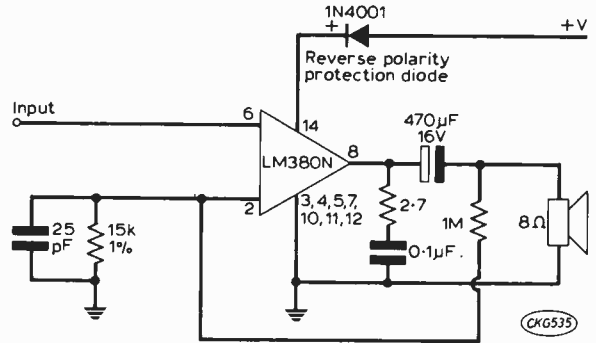

Fig. 12: Increased gain may be obtained by the use of positive feedback.

The maximum gain is around 300, since attempts to obtain still higher gain may merely result in oscillation.

SUPPLY POLARITY

As in the case of most integrated circuit audio amplifiers, if the power supply to the LM380N is applied with the polarity reversed, a large current will flow and the device will almost certainly be destroyed within a few milliseconds.

Readers may therefore wish to incorporate a diode in one of the power supply lines (normally the positive line). If a supply of reverse polarity is accidentally applied to the circuit at any time, the diode will prevent any appreciable current from flowing and will thus protect the LM380N. It is, of course, essential that the diode is connected with the correct polarity, see Fig. 12.

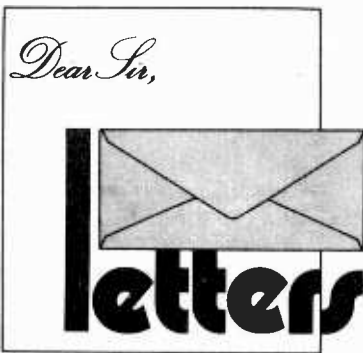

Microwave distance Record

On Thursday, 13th September a 3cm (10GHz) contact was made between GW8CKT/P on Snowdon and GM8AZU/P on the Cairnsmore of Fleet. We believe that, at 212.5km, this is a new British distance record.

Weather conditions were far from ideal, with gale force winds and both ends of the link well above the cloud base. Visibility

on Snowdon at 3560 feet was only 15 yards, and on the Cairnsmore of Fleet at 2300 feet was only 20 yards. The high wind on Snowdon made it impossible to use a dish aerial and so a 10dB horn was used. At the Scottish end a 32in. dish was used, and a considerable amount of luck was in evidence when the beam heading, estimated using a cheap plastic compass, turned out to be correct to better than 0.5°. Earlier attempts to find a signal using a 10in. dish at the Scottish end had failed. Signal reports exchanged were readability 5 and strength 6/7.

Equipment used at GM8AZU/P: Tx, Mullard CXY19 Gunn device, output approximately 100mW; Rx, Mixer CS10B, Local Oscillator, Mullard CL8370; i.f., 70MHz; ANT, 32 inch dish with horn feed.

Equipment used at GW8CKT/P: TX, Mullard CXY19 Gunn device, output approximately 120mW; RX, Mixer, balanced pair of Mullard BAW95, Local Oscillator,

Mullard CL8380; i.f., 70MHz; ANT, Small horn.

The equipment, which was all solid state, was carried to the summits of the two mountains concerned. Pundits who ask why the GW team did not use the train, may be interested to know that the train was not running due to the bad weather so it's just as well that they bargained on climbing!

80m talkback was used between the two base camps in order to co-ordinate the departure for the climb to the summit.

2m talkback was used from summit to summit.

Those involved were:—

At the GM end: G3VUQ, G3YCO, G8AMG, G8APZ, G8AZU, G8DKK. At the GW end: G3XSO, G3YMV, G8BPN, G8CKT, G8ENX, G8FTB, G8HCO.—**Michael H. Tooley, G8CKT**, (Weybridge, Surrey).

—continued on page 762

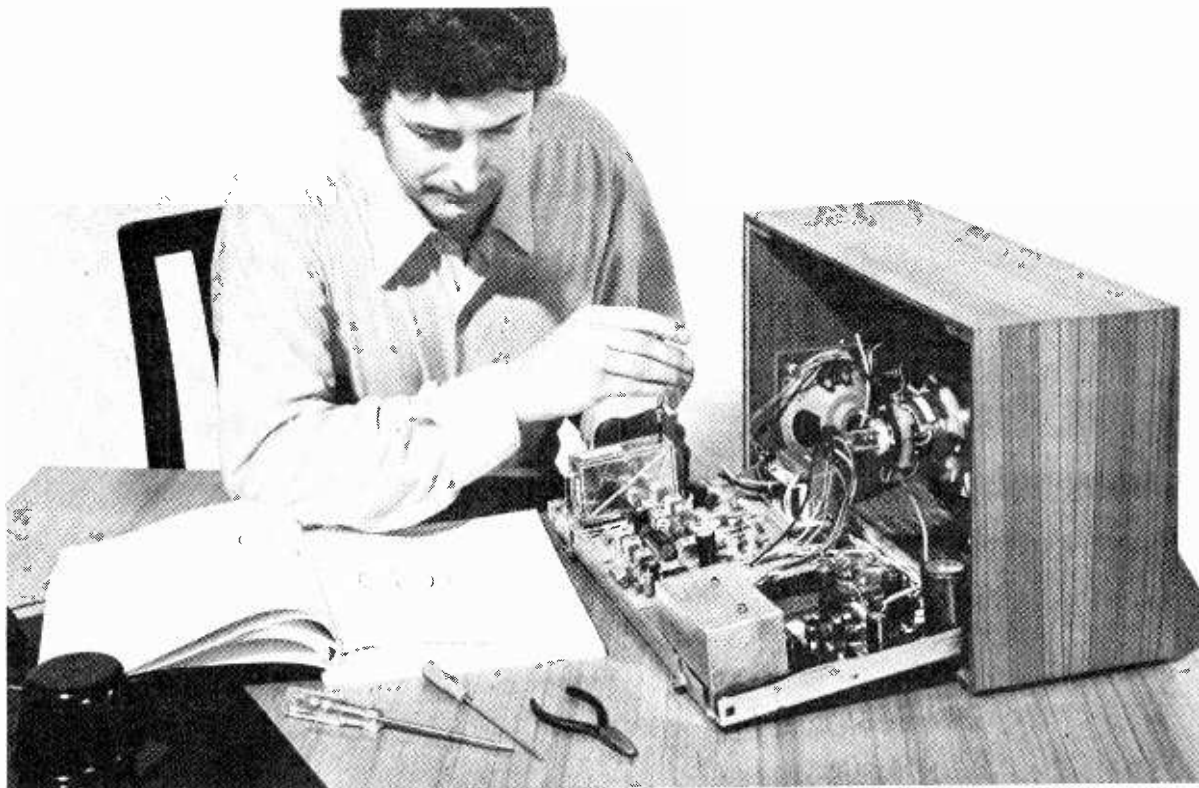

LEARN about MODERN TV Design by building this Heathkit 12" B/W Portable

The new Heathkit GR-9900 portable 12" UHF Monochrome Television kit. A unique chance to double the pleasure available from any other television set — because you build this yourself.

We've used the latest modular construction and advanced design concepts to produce an outstandingly high performance TV worthy of the Heathkit name. All the main electronics are mounted on two easy-to-assemble printed circuit boards—this plus the use of no less than four integrated circuits perform the complex function of IF, video, sound, line and frame scan. Factory pre-aligned coils make alignment very easy and there are four presettable pushbutton controls for channel tuning—a luxury found in very few other models. The quality and fidelity is therefore excellent, and of a far higher standard than most ready-built televisions in the shops.

The GR-9900 is portable too—equally at home on

the mains or off your 12 volt battery for car, boat or caravan use. Add to this Heath's world renowned experience in the design of equipment for first-time kit builders, and you will be impressed on all counts of engineering, styling, and performance.

The instruction manual is surprisingly simple with big, clear illustrations to map out your way. Would-be TV engineer? Here's your chance to learn—by actually building a television yourself. The manual not only shows you how to get 100% personalised quality control on your own; in the event of anything going wrong, a Trouble-Shooting section enables you to find the fault—and, in most cases, to put it right unaided.

The GR-9900 is a kit you'll be proud to build and own. You have a choice of fully finished cabinets in teak or modern white and the kit price, £62.70 (carriage extra), includes a FREE high performance indoor aerial.

FREE Heathkit Catalogue

Contains something for everyone: Hi-Fi Stereo, Testers & Instruments, SWL, Metal Detectors ... even a Battery charger Kit. Mail the coupon ... Today! Heath (Gloucester) Limited, Gloucester GL2 6EE.

LONDON showroom
233 Tottenham Court Road
Tel 636 7349



Choose cash or Heath Monthly Budget Plan

(Mail order prices and specifications subject to change without notice)

Please send me a FREE Heathkit catalogue

Name _____

Address _____

HEATH

Schlumberger

Dept PW/12/73

Heath (Gloucester) Limited,
Gloucester GL2 6EE. Telephone 0452 29451



WILMSLOW AUDIO

THE Firm for speakers!

SPEAKERS

EMI 13 x 8, 3, 8 or 15 ohm	£2.03
EMI 13 x 8, 150 d/c 3, 8 or 15 ohm	£2.25
EMI 13 x 8, 450 c/w 3, 8 or 15 ohm	£3.60
EMI 13 x 8 type 350 8 ohm	£8.25
EMI 6 1/2" 93850 4 or 8 ohm	£2.80
EMI 8 x 5, d /Cone Roll/s 8 ohm	£2.50
Baker Group 25 3, 8 or 15 ohm	£6.60
Baker Group 35 3, 8 or 15 ohm	£7.50
Baker De Luxe 12" d/cone	£9.62
Baker Major 12"	£7.50
Kef T27	£4.67
Kef T15	£5.50
Kef B110	£6.16
Kef B200	£7.42
Kef B139	£10.72
Kef DN8	£1.92
Kef DN9	£1.37
Kef DN12	£4.12
Kef DN13	£2.75
Fane Pop 100 watt 8/15 ohm	£21.45
Fane Pop 60 watt 8/15 ohm	£12.26
Fane Pop 50 watt 8/15 ohm	£10.17
Fane Pop 25/2 25 watt 8/15 ohm	£5.94
Fane Pop 15 watt 8/15 ohm	£4.40
Fane Crescendo 15" 8 or 15 ohm	£27.50
Fane Crescendo 12A 100w 8 or 15ohm	£24.20
Fane Crescendo 12B 75w bass 8 or 15	£24.20
Fane 80T7 8" d/c roll/s 8 or 15 ohm	£3.85
Fane 80T8 8" d/c cone 8 or 15 ohm	£2.64
Goodmans Axent 100 tweeter	£6.60
Goodmans 8P 8 or 15 ohm	£3.80
Goodmans 10P 8 or 15 ohm	£4.49
Goodmans 12P 8 or 15 ohm	£11.55
Goodmans 15P 8 or 15 ohm	£17.05
Goodmans 18P 8 or 15 ohm	£29.70
Goodmans Twinaxiom 8	£6.79
Goodmans Twinaxiom 10	£7.61
Elac 9 x 5 5" 59RM109 15 ohm,	
59RM114 8 ohm	£2.53
Elac 6 1/2" d/c roll/s 8 ohm	£3.22
Elac 6 1/2" d/c cone 8 ohm	£2.59
Elac 4" tweeter TW4	£1.21
Wharfedale Bronze 8 RS/DD	£3.11
Wharfedale Super 8 RS/DD	£5.50
Wharfedale Super 10 RS/DD	£9.80
Coral 6 1/2" d/c cone roll/s 8 ohm	£2.42
Siran 6 1/2" 3 or 8 ohm	£1.44
Richard Allan 12" d/c 3 or 15 ohm	£2.20
10" x 6" 3, 8 or 15 ohm	£1.92
8" x 5" 3 or 8 ohm	£1.38
7" x 4" 3 or 8 ohm	£1.38
2 1/2" 64 ohm or 70 mm 80 ohm	£0.65
Adastra Hiten 10" 10w 8 or 15 ohm	£2.80
Eagle DT33 dome tw.	£5.45
Eagle HT15 tweeter	£3.66
Eagle CT5 tweeter	£1.25
Eagle CT10 tweeter	£2.54
Eagle MHT10 tweeter	£3.74
Eagle FR4	£4.45
Eagle xover CN23, 28, 216	£1.10
5p. matching transformer 3-15 ohm	£1.10
Celestion MF1000 25w horn 8 or 15 ohm	£10.45
Celestion P58 (for Unilux)	£2.16
Celestion G12M 8 or 15 ohm	£12.00
Celestion G12H 8 or 15 ohm	£15.00
Celestion G15C 8 or 15 ohm	£24.00
Celestion G18C 8 or 15 ohm	£33.00
Car Stereo speakers—ask for leaflet.	

SPEAKER KITS

Wharfedale Unit 3	£8.25
Wharfedale Unit 4	£14.50
Wharfedale Unit 5	21.00
Richard Allan Twinkit	£7.33
Richard Allan Triple 8	£10.76
Richard Allan Triple Assem.	£16.20
Richard Allan Super Triple	£19.36
Goodmans DIN 20	£8.58
Fane Mode One	£9.00
Kefkit 2	£25.75
Kefkit 3	£35.50
Peerless 2-8	£5.50
Peerless 10-2	£8.47
Peerless 20-2	£10.41
Helme XLK 25 (Pair)	£18.17
Helme XLK 50 (Pair)	£37.18
Stephenspeaker kits and cabinets—send for free booklet "Choosing a Speaker". Prices include VAT.	
Carriage and insurance 75p per kit	

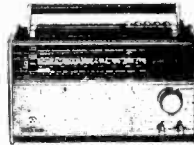

RADIOS/CASSETTES/AMPS.

Grundig Mariner TR865	£22.00
Grundig Elite Boy 500	£27.00
Grundig Melody Boy 500	£27.00
Grundig Melody Boy 1000	£38.75
Grundig Yacht Boy 210	£34.25
Grundig RF430 mains	£27.00
Grundig RF310 mains	£22.75
Grundig RF310	£21.25
Grundig Top Boy	£16.75
Grundig Satellit 1000	£121.00
Grundig C402 cassette	£27.00
Grundig Signal 500	£27.00
Grundig C230 Cassette	£28.00
Tandberg TP41	£42.00
BASF 9301 radio/cassette	£58.00
Bush VTR178 5 Band (Inc. Air)	£29.00
Trio KA2000A	£33.00
Trio KA2002	£41.00
ITT Colt	£9.95
ITT/KB Golf Preset	£21.25
ITT/KB Weekend Auto	£16.00
ITT/KB Europa	£18.00
ITT/KB SL53 cassette	£22.82
ITT/KB Studio 73 stereo cassette	£44.00
Koyo KTR 1664 8 waveband	£40.00
Koyo KTR 1770 11 waveband	£56.50
Koyo KTR1883 5 Band (Inc. Air)	£23.50
Tec C200 Radio/Cassette	£31.00
Prices include VAT.	
Carriage and insurance 75p. FREE with each radio—"World Radio Stations Book"	

PA/DISCO AMPLIFIERS

Carriage and insurance £1.00	
Baker 100 Watt	£40.00
Linear 30/40	£25.00
Linear 40/60	£30.00
Linear 80.100	£55.00

FREE with speaker orders over £7

"Hi-Fi Loudspeaker Enclosures" book. All units guaranteed new and perfect. Prompt despatch.

Carriage and insurance 35p per speaker (tweeters and crossovers 20p)

ALL PRICES QUOTED INCLUDE V.A.T.

WILMSLOW AUDIO Dept. P.W.

Loudspeakers: Swan Works, Bank Square, Wilmslow, Cheshire SK9 1HF. Radios etc: 10 Swan St., Wilmslow, Cheshire SK9 1HF.

Telephone Wilmslow 29599

JOSTY KITS SPECIAL OFFER

To celebrate our Introduction to this famous range of Danish kits we are offering them free of V.A.T. and postage. All models are available. For prices see the Radio Supplies advert or send an s.a.e. to us.

BATTERY ELIMINATOR BARGAIN

The most versatile eliminator ever offered. Input from AC mains. Output selected by switch is 3, 4, 5, 6, 7, 5, 9 and 12V DC at 500 mA. ONLY £3.60 (50p)



NEW SINCLAIR CAMBRIDGE CALCULATOR

ONLY £26.45 (£3.00 Fully built)

SINCLAIR EQUIPMENT



Project 605	£19.90 (£2.30)
Pro 80 AFU £5.38 (74p), Pro 80 tuner £8.95 (£1.10)	
Z40 £4.25 (63p) Stereo 80 Preamp £9.53 (£1.05)	
Z60 £5.38 (74p) Project 80 decoder £5.69 (77p)	
Z30 £3.50 (55p) Stereo 60 £7.80 (98p)	
Z50 £4.30 (65p) Trans PZ8 £2.95 (50p)	
PZ5 £3.47 (57p) 2000 Amp £28.00 (£3.00)	
PZ6 £8.30 (83p) PZ8 £6.40 (84p)	
AFU £4.40 (64p) Q16 Tuner £5.90 (79p)	

PROJECT 80 KIT

£2.70 (49p)

Our extremely popular kit contains the extra capacitors, din plugs and sockets, cable and fuseholder needed to complete Project 60.

IC RADIO CHIP TBA651

£2.10 (32p)

The world's most advanced IC radio chip. Contains RF Amp, oscillator, mixer, IF Amps, wide range AGC circuitry and voltage stabilizer. With data £2.10 (32p). Send S.A.E. for free leaflet. A kit of resistors, capacitors and IF filters is available to go with the chip for £1.75 (29p).

SINCLAIR SUPER IC12

£2.10 (43p)

Supplied complete with free 44 page instruction booklet and printed circuit

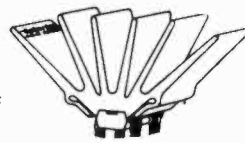

IC12 DELUXE KIT

Includes all parts for the printed circuit and volume, bass and treble controls needed to complete the mono version £1.55 (26p). Stereo model with balance control £3.50 (46p).

BASIC KIT FOR THE IC12

Contains components for P.C. board and volume and simple tone controls. Mono version £1.25 (24p). Stereo model with balance control £2.90 (40p).

IC12 POWER KIT

A set of components to construct a 28V 0.5 Amp power supply £2.47 (50p).

LOUDSPEAKERS FOR THE IC12

5" 8 ohm £1.10 (27p), 5" x 8" 8 ohm £1.85 (37p), 10" x 8" 15 ohm £2.20 (44p).

IC12 PREAMPLIFIER KITS

Type 1 for magnetic pickups, mics and tuners. Mono model £1.30 (24p). Stereo model £2.30 (34p). Type 2 for ceramic or crystal pickups. Mono model 60p (17p). Stereo £1.20 (23p).

SEND SAE FOR FREE LEAFLET ON KITS

S-DECS AND T-DECS

S-DECS £1.44 (25p)

T-DECS £2.88 (40p)

μ-DEC A £3.18 (43p)

μ-DEC B £5.94 (71p)

16 diil IC carriers £1.20 (17p)

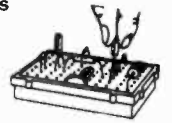

SWANLEY ELECTRONICS

32 Goldsel Rd., Swanley, Kent

Please add the sum shown in brackets after the price to cover the cost of post and VAT. Official credit orders from local authorities and school etc., welcome. Lists 10p. Mail order only. No callers, please.

GOING BACK...

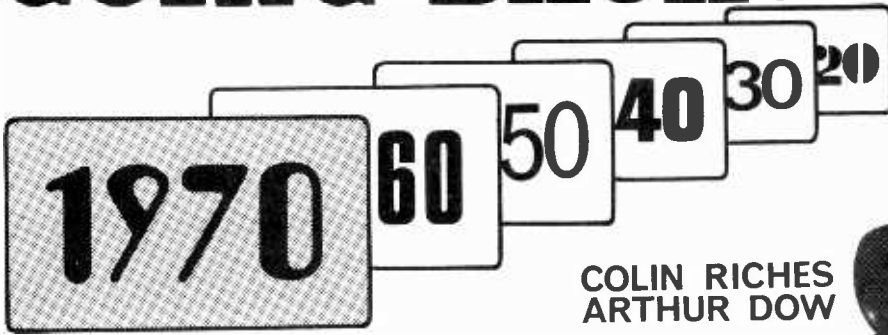

COLIN RICHES
ARTHUR DOW



Letter from America

FOR several years I have read your column religiously and at long last decided to write to you. Needless to say I have an avid interest in Vintage Radio. However, I have had to content myself with vintage parts, valves, radio books and magazines. Additionally I construct simple vintage radios out of antique parts using my own circuits or those from Hugo Gernsback publications from the early '30's. My valve collection fortunately contains many good useable valves. At present I am constructing a short wave receiver (semi-antique) using types '35 and '27 (U.S. tubes) and meant for mains operation.

I started my radio hobby in 1928 with a commercial crystal set (Vario Couple Type). I made crystal sets until 1932 when I started on valve short wave and medium wave receivers. My hobby continued through 1935 and 1936. It was interrupted in 1937 by my joining the U.S. Army. I did only occasional short wave listening thereafter until 1946 when I went back to radio construction.

My recent vintage radio construction includes a one tube SW receiver (using a transmitting type '30). The coils (plug-in) are my originals from 1932. These are about the only parts surviving from that era. While I was in the army in pre-World War 2 days, a relative threw the rest away! I also have two surviving books.

The other receivers are a Short Wave Portable which is a good copy (including original vernier dial) from an article in a 1933 Short Wave Craft Magazine. I had been planning to build it for decades and only made it last year. Also I have a breadboard type Medium Wave receiver using a type '99. (A very good performer with one modern part—a ferrite rod aerial in it). I use it mostly for a quick test of old tubes. Much better than the tube tester!

I possessed one vintage radio in recent years (an RCA Radiola) but an avid collector got it away from me. All I have at the moment is a vintage tube tester, Signal Generator and Output meter (Weston, circa 1929). The trouble is that some collectors in this country possess 100 to 300 radios leaving none for us pickers.—**Chester A. Beck, K6DFP**, (9045 Margaret Street, Downey, California, 90241, U.S.A.)

Mr. W. H. Quick tells us that he has been given an old one-valve radio which he would like to get going. He would like to know what the L.T. and H.T. voltages are. There is a 1.5A fuse fitted and we show in the diagram the front panel and a plug-in coil which fixes to the side of the set.

If anyone can help Mr. Quick, they can contact him at 15 Beechwood Grove, Horbury, Wakefield, Yorkshire.

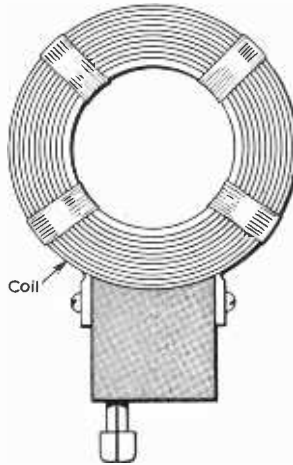

Mr. Quick's plug-in coil and the front panel of his vintage receiver.

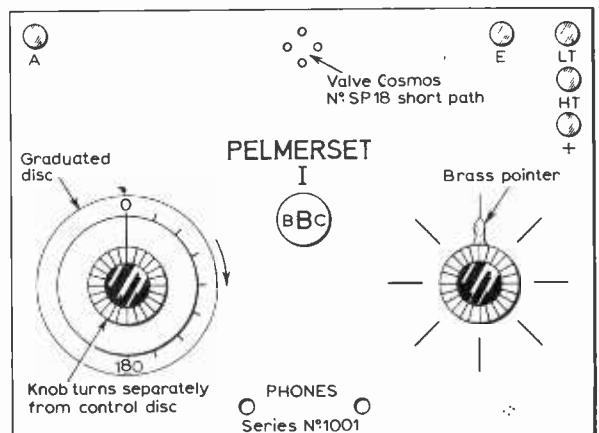

○ = Brass terminals

EXPERIMENTAL WORKSHOP

M. J. HUGHES M.A.

LEARNING BY PRACTICAL PROJECT STEPS

PART 3—TRIGGER CIRCUITS

LAST month we saw that there is, at least, one circuit which is sensitive to the rate of voltage change, i.e. the divider circuit would only respond correctly if we caused rapid changes in lighting level at the photo cell; slow changes would not make the divider work. There are other circuits

which like to see what are known as "fast going edges" to signals; as a result, a range of circuits has been developed which will accept slow changing inputs and convert these into signals having fast rise and fall times.

These circuits are called *triggers* because their

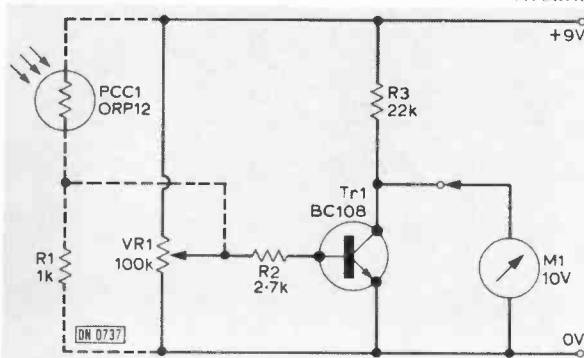

Fig. 14a If PCC1 and R1 are used as alternatives, omit VR1 and link in PCC1 on the "left-hand" end of R2.

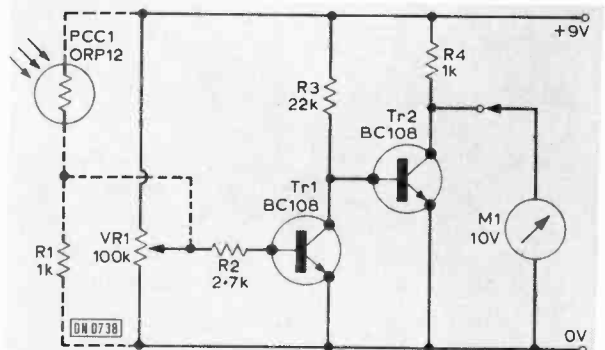

Fig. 15a The extra stage of amplification effectively improves the rise time of the output signal between the power rail extreme voltages.

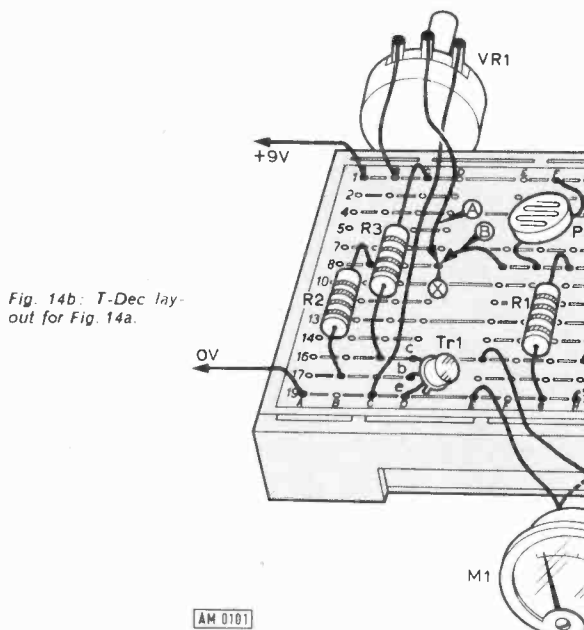

Fig. 14b: T-Dec layout for Fig. 14a.

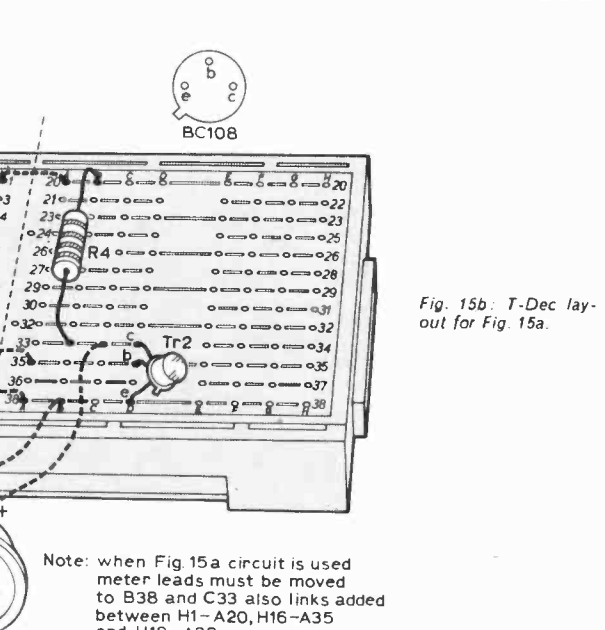

Fig. 15b: T-Dec layout for Fig. 15a.

Note: when Fig 15a circuit is used meter leads must be moved to B38 and C33 also links added between H1-A20, H16-A35 and H19-A38

output will always be in a certain state (say zero volts) until the input signal rises to a certain level and, irrespective of the time it takes the input to get to this level, when the critical voltage has been reached the output changes to a higher level (say +9V) instantaneously.

In practice everything takes a certain amount of time to happen, so "instantaneously" is, perhaps, too strong a term to use. Nevertheless, as you will see if you do some of the following experiments, we can make extremely slow voltage changes trigger a circuit to give edges to waveforms that change from one level to another in a few millionths of a second.

Fast and slow "edges"

First of all we had better look at what we are calling an "edge" so that we can compare the difference between fast and slow edges. Fig. 14a is a very simple transistor amplifier stage which gives an output inversely proportional to the voltage at the wiper of VR1 (or, if you are using the photocell alternative, the junction of PCC1 and R1).

Measure the voltage at the collector of Tr1 with VR1 set to the bottom of the track (Alternatively completely shade PCC1). You should read about +9V because the transistor, in the absence of base current, is not conducting. Slowly increase the voltage at the wiper of the potentiometer by rotating it (or slowly increase the amount of light falling on PCC1); base current will start to flow and the voltage at the collector will start to fall.

The thing to notice is that you can control the level of the measured voltage quite easily and get any value you like by careful adjustment of VR1 or the amount of light falling on PCC1. Try and get a "feel" for the rate at which the measured voltage changes for given rates of moving the potentiometer or illuminating the cell.

You can use the wires A or B in the layout and transfer one, or other, of them to point X—depending on whether you were using the cell or the potentiometer. Fig. 15a shows an extra stage of amplification. Carry out the same experiment but now measure the voltage at the collector of Tr2. Obviously the extra stage gives us inversion so when the potentiometer is down the measured voltage is low.

Now slowly increase VR1 until the voltage starts to rise and then try and control it in the same way as before. It should be very apparent that, for the same rate of change in position of the wiper of

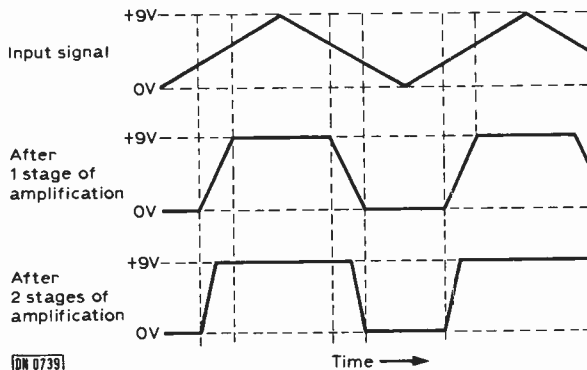

DN 0739

Fig. 16: Note the increased amplification appears to enhance the signal's rise time between the supply voltage limits.

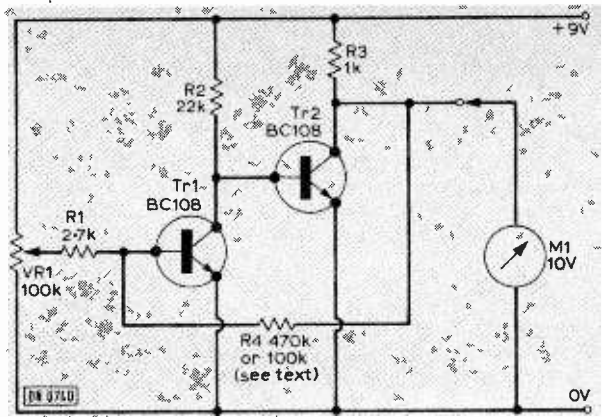
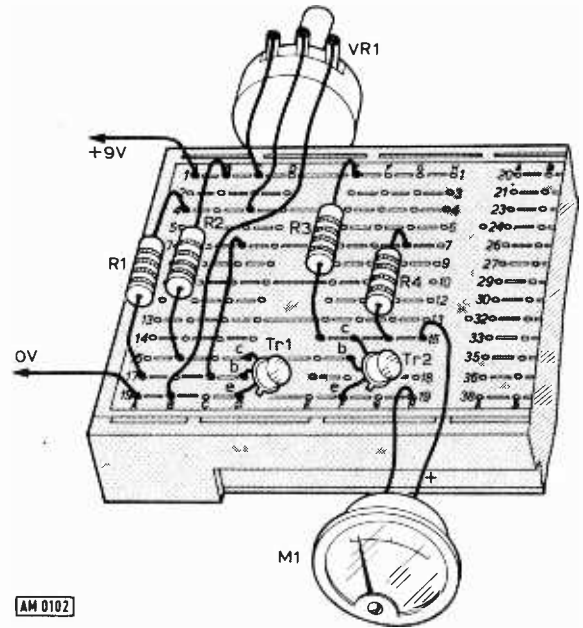

Fig. 17a: True trigger action is obtained by using positive feedback via R4.



AM 0102

Fig. 17b: T-Dec layout for Fig. 17a.

the potentiometer, the voltage at Tr2 goes from zero to +9V very much quicker than it did before.

It is, however, still possible to set it mid-way between the two extremes by careful adjustment. The effect is even more pronounced using the photocell and you should start to appreciate the increase in the rate of change of the signal at the output.

Amplification

The signals we have been talking about can be described as waveforms as shown in Fig. 16. The portion of the signal between the low and high voltages of the output is called an edge and you can see that it has become much steeper with the extra amplification.

Simple amplification thus increases a signal's rise time but there is still the possibility of getting a mid-rail voltage during the transition—especially if the input signal was unusually slow. Ideally we

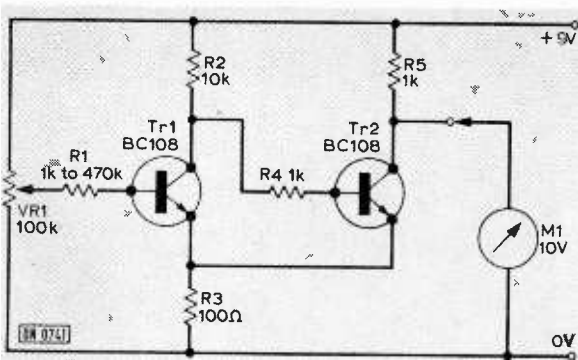

Fig. 18a: Schmitt trigger circuit. The trigger level can be controlled over small limits by changing R1 in the range 1kΩ to 470kΩ.

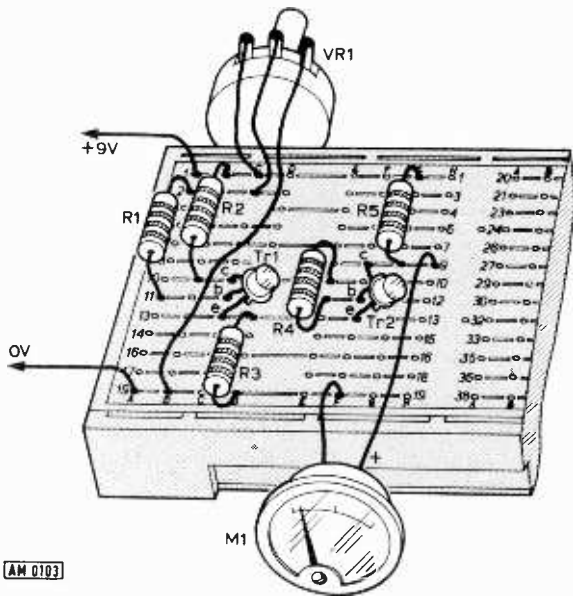

Fig. 18b: T-Dec layout for Fig. 18a.

would like to have a circuit that gives a fast change irrespective of the rate of change of input. The circuit in Fig. 15a has been modified in Fig. 17a with a resistor coupling the output back to the input. We have introduced a positive feedback loop.

If VR1 is slowly increased the voltage at Tr2 collector will, at some time start to rise; when this happens current starts to flow through R4 back into the base of Tr1 and effectively increases the base current we are already applying from the potentiometer. The effect is to make the voltage at Tr2 rise even more enhancing the effect until eventually Tr2 is totally non-conducting. All we needed to do was set the operation in motion by initiating base current into Tr1; once that was started the voltage at Tr2 collector would move from zero to +9V without any further movement of the potentiometer—the feedback loop did the rest.

The feedback cycle occurs extremely rapidly (the speed is limited only by certain internal parameters of the transistors) so the output changes level at a speed set by the circuit and no longer by the rate at which we turn the knob on VR1. Try it for your-

self and you will find it impossible to set a mid rail voltage at the output.

When VR1 is at the limit of its travel, try turning it down; the same thing happens on the downward going edge of our input signal. Notice that there is a sort of “no-mans-land” between the positioning of the wiper for upward going triggering and downward triggering. This is known as “hysteresis” and is very useful in differentiating between the two levels we are considering.

Hysteresis

In this circuit, you can control the amount of hysteresis by means of the value for R4. A 470kΩ resistor will give the smallest differential between upward and downward triggering levels but by reducing it to 100kΩ you can widen the gap between the levels. This circuit is operating as a true trigger and the feature to take note of is the use of positive feedback to speed up the edge. If you think about the circuit a bit you will find it is not very different from the bistable described last month.

Schmitt trigger

Probably the best known trigger circuit is the Schmitt trigger shown in Fig. 18a. When the voltage

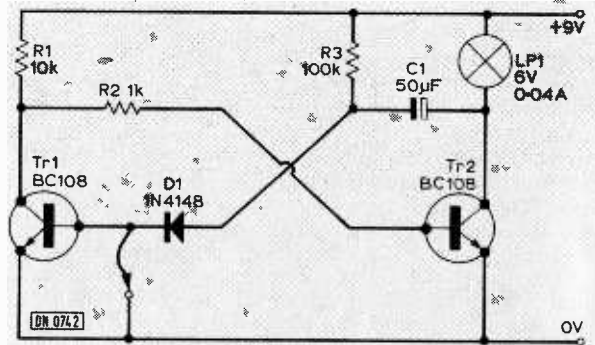

Fig. 19a: Basic monostable multivibrator. Capacitor C1 can be increased to 3,000 μF to extend the dwell time.

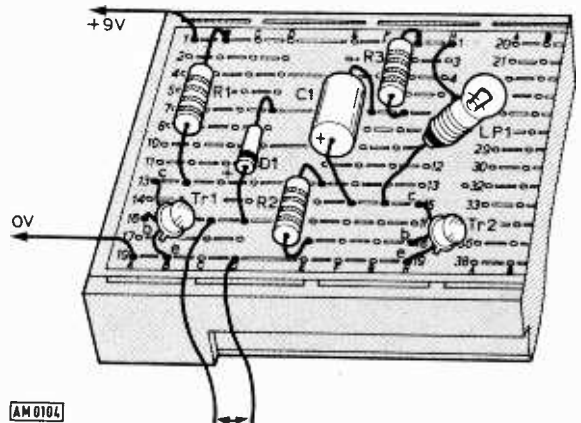

Fig. 19b: T-Dec layout for Fig. 19a.

at the wiper of VR1 has reached a certain level base current will start to flow in Tr1 and the voltage at its collector falls slightly; this reduces the base current into Tr2. The two emitters are, however, connected together and as Tr1 starts to conduct the voltage at the "top" end of R3 starts to rise.

Because this is connected to the emitter of Tr2 we reduce—even more—the potential difference between Tr1 collector and Tr2 emitter thus the base current into Tr2 becomes less. Here again we have a positive feedback loop caused by emitter coupling and the effect of this is to accelerate Tr2 going out of conduction and the output voltage drops very rapidly.

Again this occurs independently of the rate we are applying signal at the input and the speed is limited only by the transistors' parameters. Reduce the input voltage slowly and the opposite happens.

Monostable multivibrator

Another circuit which often comes into the category of trigger circuits is the "monostable multivibrator" shown in Fig. 19a. Unlike the Schmitt trigger it is a little bit more complicated to initiate triggering but it offers a useful bonus. It has a "short term memory". We can design it so that it will trigger rapidly on the receipt of a suitable signal but the output from it stays at the new level for a fixed period of time before rapidly returning to its original state.

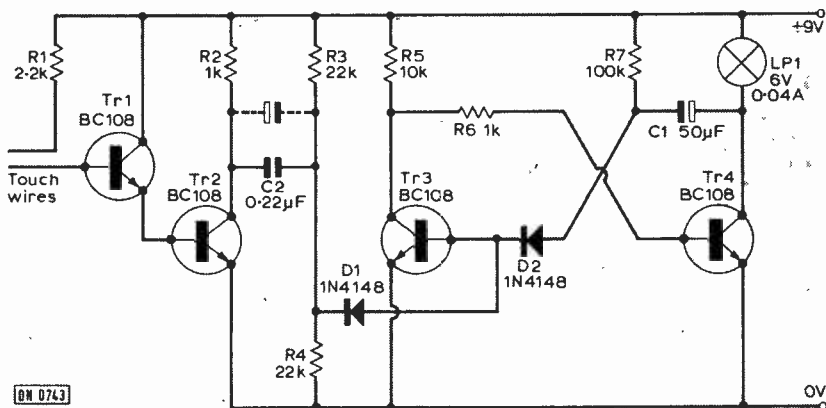

Fig. 20a: Touch-sensitive child's room-light. Supply current is approximately 1mA rising to about 80mA when the lamp is on. Duration of 3½ minutes can be obtained by making C1 3,000µF and C2 50µF. The capacitor shown dotted, across C2, indicates how it is connected—plus to R2.

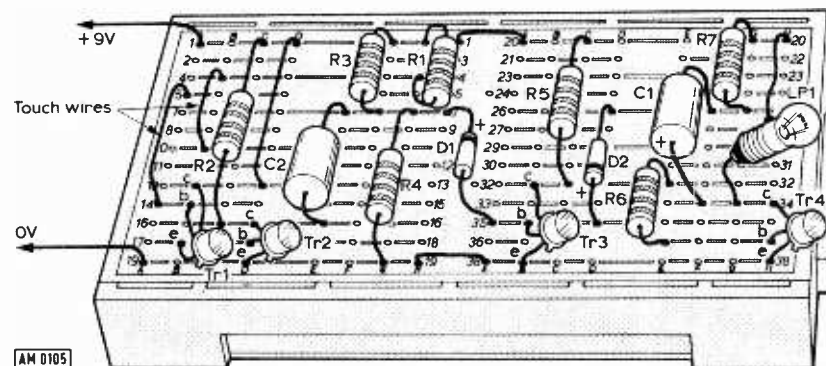

Fig. 20b: T-Dec layout for Fig. 20a.

Make up Fig. 19a on T-Dec and follow this brief description of how it works. Initially let us state that D1 serves no purpose in the circuit except to protect the emitter base junction of Tr1 from a high reverse voltage that is generated during the switching operation.

When the circuit is switched on the lamp may go on for a few moments until things have settled down. When the lamp has gone off we should arrive at a stable state of affairs in that base current is provided for Tr1 through R3—hence its collector is at near zero volts; because of this Tr2 will be cut off and the potential at its collector will be high (about +9V); consequently the lamp will be off.

If we deliberately knock Tr1 out of conduction, by rapidly short-circuiting its base to ground with the flying leads, we can momentarily establish base current in Tr2 and it conducts. The light goes on and the voltage at its collector drops to about zero. However the capacitor transmits this negative-going voltage excursion to the base of Tr1 and the potential at the junction of R3 and C1 falls to about -8V (it was previously +1.2V caused by the forward voltage drops of D1 and the base emitter junction of Tr1).

Assuming we have immediately removed our short-circuit link Tr1 will stay out of conduction because no base current can flow until the potential at the anode end of D1 has regained its level of +1.2V and this will take time because the negative end of C1 has to charge back to this value through R3. This takes quite a few seconds and during this period the lamp stays alight.

When this has been reached, Tr1 starts to go back into conduction and the potential at its collector falls giving rise to an increase in voltage at Tr2 collector; this is fed back momentarily through C1 and enhances the base current into Tr1 (positive feedback again). As a result of all this the lamp switches off very rapidly. If you have a 3,000µF capacitor you can substitute it for C1 and get a "dwell" time of about 3½ minutes. The dwell time can be calculated as $0.7 \times C1 \times R3$ (C in Farads R in ohms and the time will be in seconds).

Touch switch

The monostable thus gives us trigger action and a timing function which can be put to many uses. A novel circuit for a safe child's bedside light is shown in Fig. 20a. It is a touch sensitive switch coupled to a monostable that switches on a lamp for a pre-determined period of time (Warning: the novelty is more likely to keep a child awake than get him off to sleep!).

continued on page 756

HOTLINES

ON RECENT DEVELOPMENTS

THE YEN

HAVE you ever had a yen to do something?—the Japanese have. My ageing eyeballs have recently scanned a report which comes from the Orient from an "impeccable source". In February of this year, the Electronic Industries Association of Japan found that the total sales of electronic parts and components from Japan amounted to 101,079 million yen—which is a lot of yen for just one month's effort. It is interesting to see how this figure breaks down. For example, electron tubes (that's valves in English or Toobs in American) in February amounted to 17,841 million yen and showed an increase in February 1972 of over 10%. Integrated circuits accounted for 8,483 yen and showed an increase over the same month last year of a staggering 92%. On these figures, the Western comics who chant "Ha so?" might easily find the answer to be "Velly well thank you".

Other news from Japan is equally interesting. One snippet from spies is that Sony are to withdraw from the electronic calculator market altogether. Another is that Government approval (Japanese) has been given for the joint enterprise between Alps Electric and Motorola for the manufacture and sale of ICs. This American/Japanese Company is aiming to sell 3,000 million yen's worth of ICs in 1974.

KEEPING A WATCH!

Still in yen land, the Japanese watch industry is claiming that some 200,000 watches using piezo-electric crystals, will be produced there this year. Production lines are eagerly being set up to manufacture C-MOS ICs and there is a hive of activity in the liquid crystal readout sector. If all this activity goes through, then clearly now is the time to watch Japan.

MINI FREQ. COUNTER

What other interesting things are happening in Japan? Well, quite apart from the considerable amount of electronics business that's taking place (would you believe that this country sold 83,349 million yen's

worth of communications equipment in 1972?) there is always the neatness, the preciseness of some of the products. Perhaps an excellent example is in the field of frequency counters—feed a signal in and the frequency is flashed up on a digital readout. Well, one Company (and I'm talking about a production item, not a prototype laboratory wonder) is marketing a miniature but professional standard frequency counter. It gives a digital readout of frequency from 15Hz to 50MHz although there is an optional pre-scaler which extends this to 220MHz at the upper limit. It's completely portable and uses internal rechargeable cells. The internal oscillator is accurate for the majority of applications having a stability of ± 0.0005 at 25°C. The size is particularly impressive—120 x 175 x 25 millimetres. Just grab yourself a ruler or do a quick mental conversion and you'll see that this slips into your pocket (there's 25.4 millimetres to the inch!).

LASER TELEVISION

One could hardly look at the Japanese electronics scene without taking in the television industry. Latest thing in this sector to catch my eye is a large screen laser colour television projector. This beastly is a considerable improvement over its younger sister which made a debut at the World Exposition in Osaka in 1970. The earlier model had a resolution of 525 lines. The latest version has a resolution of 1,125 scanning lines. A krypton ion laser is used to generate the red, while an argon ion laser emits the green and blue spectrums. Perhaps we're not at the home use stage yet, but maybe the time will come when an entire wall will light up with a full colour, 3D life-size TV screen—so real you'll be able to step through your kitchen wall and join in a quick romp with Noddy or a punch-up with Ena Sharples; the mind boggles.

In serious terms, the new laser colour television projector has some very real advantages. The image is very clear and sharp. It is also very bright and there is very little divergence, too. One feature which my Japanese contact did not highlight but which is of interest is that the

polygonal mirror used for horizontal scanning rotates in magnetic bearings. These have certain advantages over conventional bearings, notably reductions in noise and vibration.

CHINESE PUZZLE?

How many characters or words do you think there are on this page? How about a page in a Chinese newspaper then? No, I haven't nipped across on the Kowloon ferry, I'm still in Japan where a leading electronics manufacturer has just launched a very high-speed printer which prints out the Chinese language. It will produce some 600 lines of Chinese in 60 seconds which, as I'm sure you know, works out at 12,000 Chinese characters every minute. A computer is used to hold information prior to printout but manual over-ride can be used. The printout can be in either lateral or vertical rows so it doesn't matter which way you want to read it—the machine can oblige. Damn clever, those Chinese, or should that be Japanese? I'll have to get myself properly orientated.

EARTH STATIONS

In the early days, the Japanese electronics industry suffered (rightly or wrongly) from a "cheap goods" brand. It is now no longer possible to regard all its products as in this category. An earth terminal is no small thing, neither is there any room for sub-standard effort. In this field, one Japanese Company alone has built, supplied and/or installed very nearly 50 (fifty) earth stations.

GET ORGANISED!

A little gem from England to finish with. In a church at the Royal Naval Air Station Yeovilton, Somerset, an electronic organ began to play itself—a radar beam was being picked up by some of the internal components. About time the Navy got itself organised!

Ginsberg

ARE YOU 'SWITCHED-ON'?

make this ULTRASONIC REMOTE CONTROLLER

By the flick of a switch from your armchair you can switch on the television, radio, lamps, intruder alarm, electric kettle, electrically operated curtains, operating rotating aerials, darkroom lights. For bedridden patients, handicapped and elderly people, there is a multitude of uses for this valuable tool, from remote signalling to opening electrically operated doors—without the need for them to go near the mains supply. Your son can have a lot of fun, too, if you make it for a Christmas gift.



IN NEXT MONTH'S PRACTICAL WIRELESS

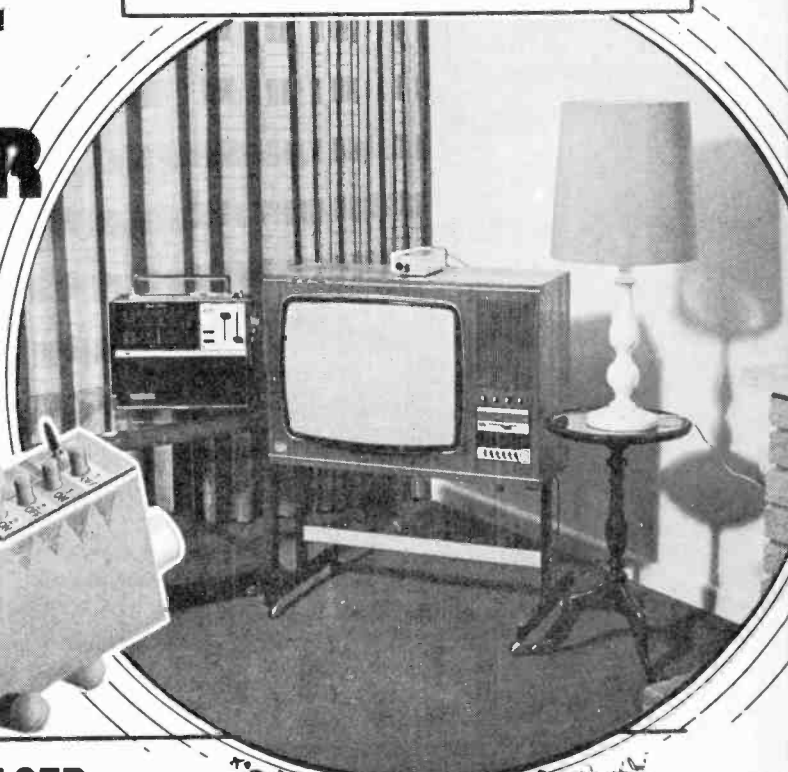

AF/HF/VHF TROUBLE-TRACER

Our Trouble-Tracer will provide you with a test signal ranging from audio to VHF. Test probes pick up signals from the equipment under test and feed them into an amplifier and speaker. All in the one cabinet—What else could you want?



Curing Radio Interference in Audio Equipment

Do you suffer interference on your tape recorder or HI-FI from nearby radio transmitters? This feature tells you how to cope with this ever-increasing problem.

**JANUARY ISSUE ON
SALE 7th DECEMBER**

PORTABLE FLUORESCENT LAMP UNIT FROM YOUR 12V BATTERY

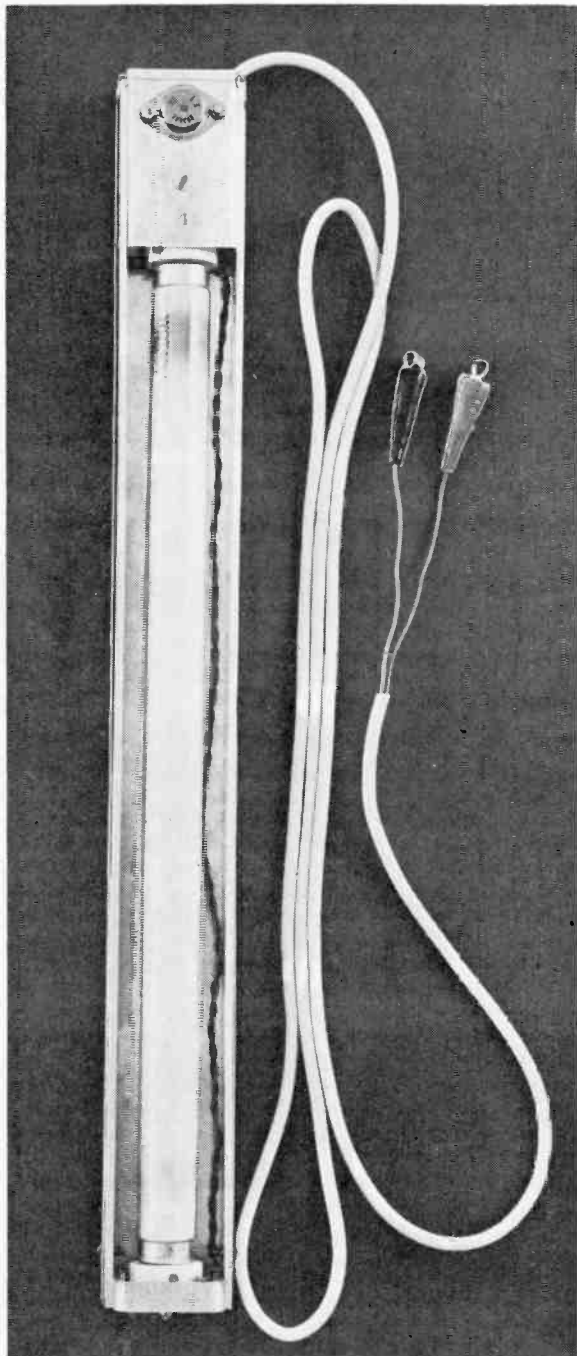

FOR: EMERGENCY LIGHTING, CARAVANS

THE battery operated 15W fluorescent lamp unit described here is of simple construction, being designed around readily available components. The whole assembly is made up in aluminium, consisting of a framework which supports the tube and houses the oscillator module. A cover plate acts as reflector and dust cover.

CIRCUIT DESIGN

Fig. 1 shows the circuit. A 2N3055 silicon power transistor operates as a transformer coupled class 'C' oscillator. The fluorescent tube is supplied from a third winding on the transformer. Satisfactory operation is obtained from 10 to 15V.

A variable resistor provided in the base circuit of the transistor ensures correct operation with devices having any gain within normal spreads. The

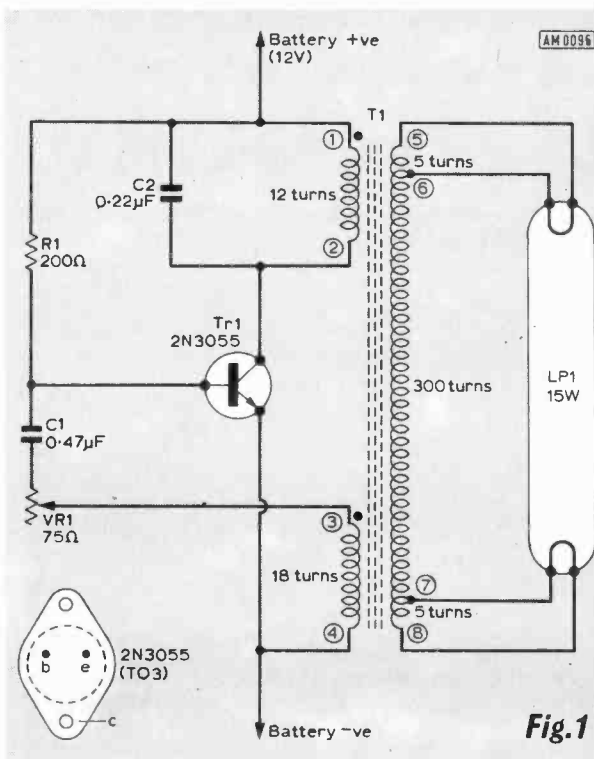

NIT ERY



VANS & CARS, LOFTS, SHEDS, GARAGES, MOBILE RALLIES, ETC...

transformer is designed around Mullard FX2242 pot cores. The collector winding is tuned by a 0.22 μ F capacitor. Bias for the transistor is provided by a 200 Ω resistor from the positive supply rail.

The operating frequency is determined by the 0.47 μ F base timing capacitor C1, the variable resistor, the tuning capacitor and the load conditions. Since the load (the fluorescent tube) is a high resistance until alight, the circuit has a "soft" start, the oscillations starting at low frequency and amplitude and building rapidly over a few seconds until settling down at steady amplitude and high frequency once the tube 'strikes'.

construction method allows assembly with the tools normally available in a small workshop. The cover plate is the most complicated piece, but being fabricated from 1/32 in. sheet this makes the work quite easy. Cutting is accomplished with a Stanley knife using a laminate cutting blade (Stanley No. 5194). The cut edges should be filed smooth. The original cover plate made by the author was bent up in a normal small metalwork vice, extra long 'jaws' being made up from 2 x 1 in. hardwood.

The oscillator housing is bent up from 1/16 in. sheet as is the tube mounting bracket. The power transistor is mounted on the oscillator housing so that the base and emitter pins are inside the casing, directly above the circuit board. One bi-pin tube connector is also firmly mounted to a bracket bent up from this housing. Two side struts are bolted on to this oscillator housing. The smaller 'U' bracket supports them at the far end and also holds the

CONSTRUCTION

The tube and oscillator housing is made up from aluminium strip and sheet as shown in Fig. 2. This

Note: It is important that the spacing of the lamp connectors is checked before final assembly.

AM 0097

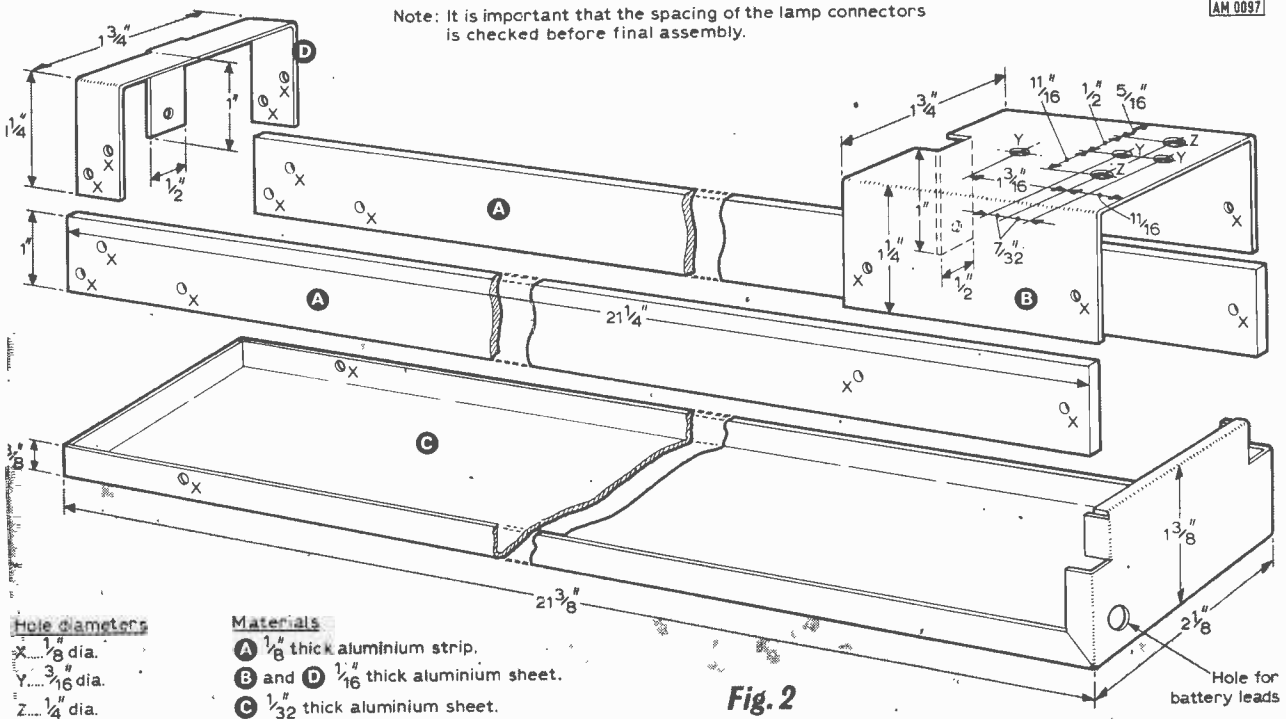

Fig. 2

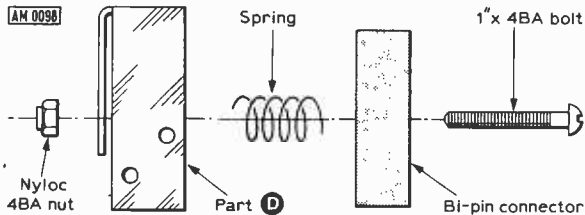

Fig. 3: Details of the spring-loaded tube connector.

other bi-pin tube connector. This connector is mounted on a 1in. 4BA bolt and spring, Fig. 3, to facilitate easy fitting of the fluorescent tube by pulling back the connector and then pushing it over the tube pins.

OSCILLATOR PCB

Fig. 4 shows full size layouts for both the component and the copper side of the circuit board. The board can be made by laying the drawing over a piece of copper clad board ready cut to size, and drilling through all the holes. It is essential that the drawing does not move during this operation. The layout can then be copied on to the board using a fine brush or mapping pen, and cellulose paint. The board can then be etched off in ferric chloride (strong) solution. (A 500ml bottle is adequate and may be obtained from most chemists to order.) After etching the board should be washed thoroughly in warm water. The paint can be removed with thinners or rubbed off with scouring powder. The components can then be mounted in place and soldered. Flying leads are required for the three transistor connections. Veroboard terminal pins are used for the four connections to the fluorescent tube.

VARIABLE RESISTOR

The variable resistor VR1 used here is primarily intended for use as a convergence control in Colour TV receivers. If difficulty is experienced in obtaining this control, it should be ordered from a TV dealer as a spare part (e.g. Decca CTV25 Part No. 535167). This control is mounted near the edge of the board so that adjustment may be made by turning the knob edge with a forefinger from the end of the lamp unit.

THE TRANSFORMER

The transformer is wound on a Mullard DT2180 bobbin. Enamelled copper wire is used throughout and all windings are wound in the same direction.

The collector winding is put on first and consists of 12 turns of 28SWG wire, the start labelled (1) and the finish (2). The turns should be wound close together. The base winding is wound directly on top of the collector winding and consists of 18 turns of 28SWG wire, also closely wound. Label the start (3) and the finish (4). Next a single turn of insulating tape is put round the bobbin to isolate the low voltage windings from the tube supply winding.

Finally the high voltage winding is put on consisting of 310 turns of 32SWG wire with taps brought out after 5 and 305 turns. This winding is layer

★ components list

C1	0.47 μ F 250V polyester
C2	0.22 μ F 250V polyester
R1	200 Ω 5W wire-wound
VR1	5 Ω pot. wire-wound (see text)
Tr1	2N3055 with insulating kit
LP1	15W fluorescent tube

Miscellaneous

Pot core (2 x half cores) Mullard FX2242 and bobbin DT2180 (available complete from Hawnt Electronics Ltd., 112 Pritchett St., Birmingham, B6 4EN for £1.20 inc.)
 Bi-pin tube connectors (2). 28 and 32SWG enamelled copper wire. PCB, 3 x 1 $\frac{1}{2}$ in. Length of twin 5A wire, as required, with two large crocodile clips.
 Aluminium: 4ft of 1 x $\frac{1}{8}$ in. strip (Part A), 6 x 5in. of $\frac{1}{8}$ in. sheet (Part B), 24 x 3in. of $\frac{1}{32}$ in. sheet (Part C).

wound, with a turn of insulation put right round the finished bobbin. The start, tap 1, tap 2 and finish should be labelled (5) (6) (7) and (8) respectively. The two ferrite cores can then be placed around the bobbin and the transformer loosely bolted on to the circuit board.

The leadouts can now be cut to length, scraped clean at the ends and soldered to their respective points on the circuit board. Once this has been

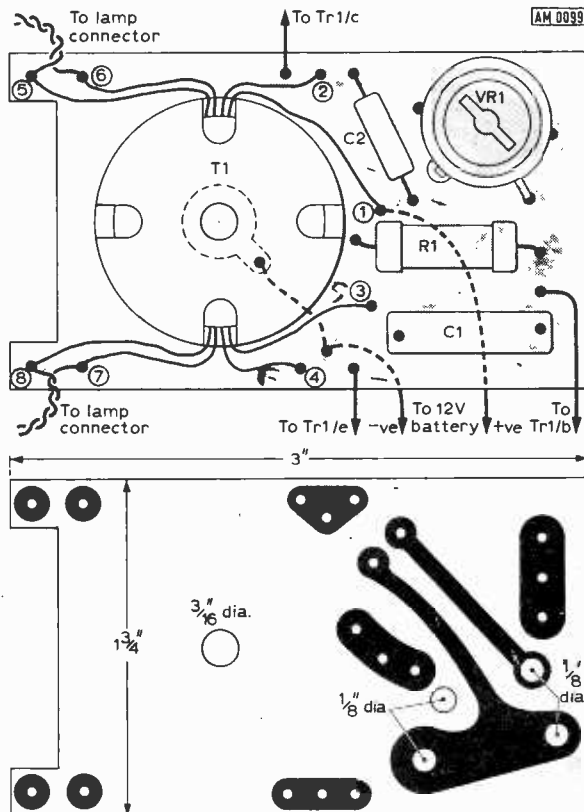

All holes drill No.55 unless otherwise stated.

Fig. 4: Full size layout of printed circuit board and component location on board.

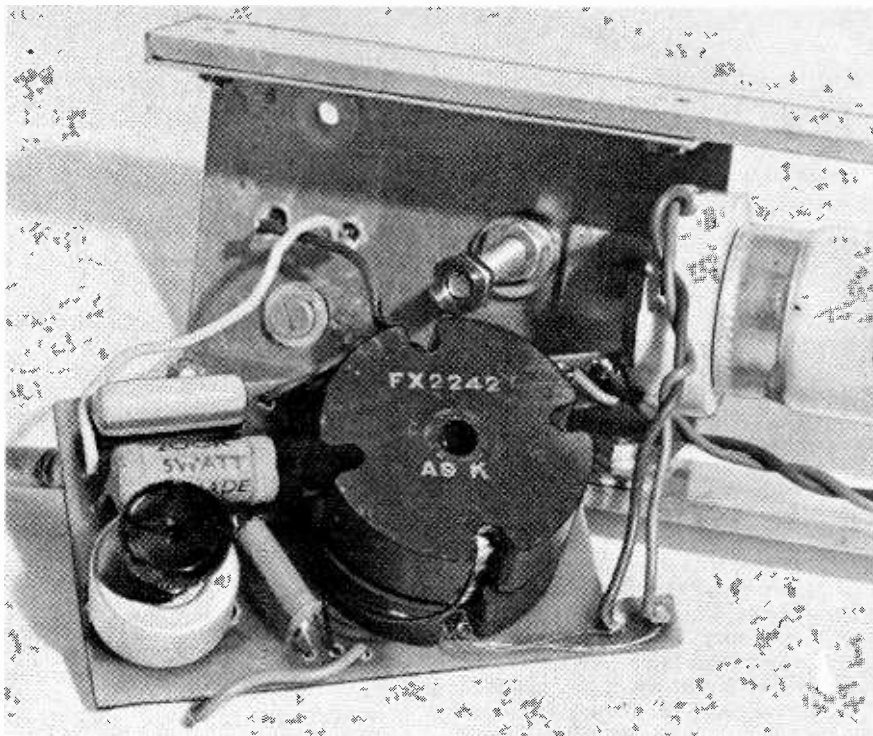

A view of the oscillator assembly at one end of the lamp unit.

done, the fixing bolt may be removed and the top ferrite core taken off. A small piece of Sellotape should be stuck on to the centre pole-piece of the core. This provides a small gap which ensures that the core cannot be saturated by the primary magnetic flux. The upper core is then replaced and held into place with a further piece of Sellotape around the join (the cores are finally held together by the module mounting bolt).

An 'exploded' view of the transformer is shown in Fig. 5 which also shows the method of mounting the module.

TESTING

The power transistor should be mounted on the module housing with a mica washer and two nylon bushes, usually supplied with the transistor. A smear of silicone grease should be applied to each side of the mica washer to ensure good thermal contact. The flying leads should be connected to the transistor, ensuring that the base and emitter leads are not reversed. The supply lead should also be connected to the copper side of the circuit board. Do not fit the tube or module into the framework yet.

Connect the power leads to a 12V supply, ensuring correct polarity. The oscillator should 'whistle' loudly, since without a load the operating frequency is lower. If the circuit does not oscillate it is probable that the phasing between the collector and base windings is incorrect. Reversing either winding should ensure correct operation.

ASSEMBLY

Once it is established that the oscillator is functioning correctly, the fluorescent tube connectors

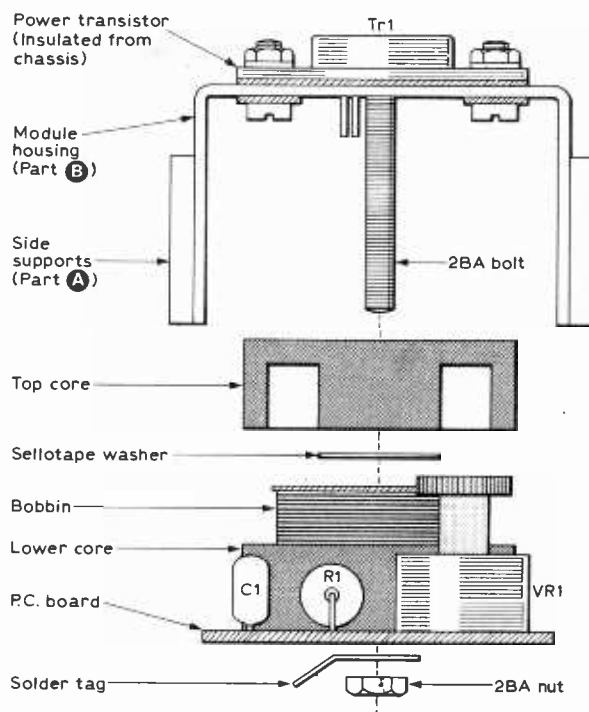

Fig. 5: An exploded diagram of the oscillator transformer and mounting.

may be wired up and the module bolted into the framework. Care must be taken not to overtighten the mounting bolt as the ferrite cores are very brittle and easily fractured. The nut can be sealed with a drop of paint or varnish. The tube can now be fitted into place and final adjustments made.

Reconnect the 12V supply, ensuring correct polarity. The oscillator should start up at a medium frequency, increasing rapidly in pitch until the tube strikes and lights. The oscillator should then be inaudible. Adjust VR1 for maximum brightness. At one end of its travel the light will be dim and at the other extreme excessive base drive will cause squegging with consequent flickering of the lamp. Once the oscillator is correctly set operation should be satisfactory over the range 10 to 15V. The current consumption should be between 1.3 and 1.5A at 12V input.

The cover plate should now be clipped on at the oscillator end and pressed home. Two self tapping screws hold the cover in place.

NOTE 1 Connecting the lamp to the battery with reverse polarity will not cause any damage since the transistor is reverse biased and cut-off, resulting in practically zero current flow.

NOTE 2 The metal framework has been left completely isolated. Slight radio interference may be caused in the immediate vicinity of the lamp unit. To reduce this interference to a negligible level (field localised to within 4ft.) the frame should be connected to either the positive or the negative supply line. Connect a short lead from either to the soldering tag on the module mounting bolt. ■

EXPERIMENTAL WORKSHOP—Part 3— Trigger Circuits—continued from page 749

If the gap between the touch wires is bridged with the fingers a minute current flows into the base of emitter follower Tr1. This produces a considerably larger current into Tr2 and its collector falls to zero. The junction of R3 and R4 is momentarily pulled down by C2 from about +4.5V to -4.5V. This negative going signal is coupled to the base of Tr3 of the monostable through D1 and this switches off Tr3 starting the monostable cycle.

The lamp goes on for the period set by C1 and R7. Capacitively coupling the touch-sensitive switch with C2 allows the user to keep his finger on the touch wires without interfering with the monostable action.

The values shown in the circuit only give a dwell time of a few seconds—for experimental purposes—but a reasonable period of time of 3½ minutes can be arrived at by increasing C1 to 3,000µF, and C2 must be increased to about 50µF.

Next month we shall look at a development of the monostable; the astable multivibrator.

COMING SOON
Q4 MATRIX
MATE

Multimeter Competition RESULT

In our June "Multimeter" Competition readers were invited to place eight features of the new Sinclair Radionics multimeter DM1 in order of appeal to the average P.W. reader.

Having considered all entries, the judges decided that the best received were a large number of identical attempts which had placed features in the following order:

1st-E; 2nd-D; 3rd-L; 4th-J; 5th-K; 6th-B; 7th-A; 8th-C.

In accordance with the rules, these tying competitors then participated in a postal eliminating contest from which the eventual winners were judged to be Mr. J. Bertram, of Fenham, Newcastle-upon-Tyne; Mr. R. Harris, Knowle, Bristol; Mr. J. R. Mann, Knaresborough, and Mr. G. Rider, Hythe, Southampton.

These four readers each win a Sinclair digital multimeter and 12 months' free copies of Practical Wireless.

The tying competitors who entered the final postal eliminating contest, and were subsequently unsuccessful, each receive a consolation prize and 12 months' free copies of Practical Wireless.

SPRING INTO ACTION

The next series of special issues of P.W. will be in the Spring 1974.

In the coming months we shall be giving advance information on our new

EXCLUSIVE P.W. PROJECTS

COMING IN THE SPRING ISSUES.

ORDER YOUR COPIES NOW

Successful Soldering

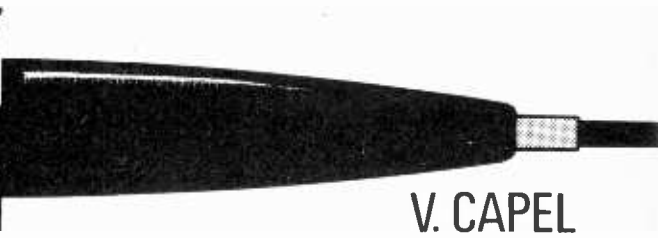

V. CAPEL

WITHOUT a doubt one of the most important tools for either professional engineer or amateur hobbyist is the soldering iron. Nearly every component has to be soldered, so whether constructional work or repairs are being carried out, the iron has to be called into use. There are a considerable number of soldering instruments of all sorts and sizes available, so in this article we will take a look at some of them to see which are most suitable for particular applications, and their respective advantages and disadvantages.

BASIC REQUIREMENTS

We will start off with what could be called the basic workshop instrument. This is an iron with the element operating at mains voltage and a wattage of between 25 and 40 watts. The size allows for most printed-circuit and general component soldering, but the bit may be rather large for some of the finer printed boards. For this reason, most irons have a variety of interchangeable bits so that a thinner one can be fitted for fine work.

In practice though, bits are not often changed according to the requirements of the job. For one thing they have a habit of getting seized-up and difficult to remove. They should really be loosened from time to time to facilitate changing, but in practice this precaution is usually neglected. Also, most workshop irons are kept on continually in order to be instantly available, so to change the bit for a particular job would mean allowing the iron to cool down and waiting for it to warm up again after the change, plus of course a repeat performance for the re-fitting of the normal bit. Going to the other extreme, irons of this type and wattage have a limited heat output and so cannot tackle large jobs.

The difference between temperature and heat-volume must be noted here. All soldering irons attain a temperature which exceeds the melting point of solder (168°C for the high-quality 60/40 grade) otherwise they would be useless for their purpose, but some deliver a greater quantity or volume of heat than others. This is determined largely by the wattage of the instrument. Hence, a soldered joint to a punched-out chassis tag may be impossible with some smaller irons because the chassis conducts the heat away faster than the element can produce it, and so the bit cools rapidly to below the required temperature. Any large area of metal will have the same effect.

Another factor is the size of the bit. The bit effectively stores heat and so acts as a reservoir. Heat flows out of the bit when the iron is used and more heat is supplied by the element. However, the out-flow can be greater than the input for a short period until the stored heat is exhausted. Thus larger areas

can often be soldered than would be feasible with a particular element-wattage, if the iron is fitted with a large bit. When the iron has been thus used, it will take longer for the bit to return to correct operating temperature than would a smaller bit because it has what is termed, a slow heat recovery time.

IDLING TEMPERATURE

A further consideration is the heat loss when the iron is switched on but is not in use, as is the case in most workshops for the greater part of the time. While the iron may get hotter than needed because there is no heat conduction by application to a work area, it must not get so hot as to damage the element or cause premature deterioration of the bit. Hence the physical size of the iron barrel and bit must not be too small for the element size so that heat losses by convection and radiation are insufficient to keep the temperature to a safe limit. It follows then, that physical size is closely related to element rating and should not be too small or too large.



Stiron 20W and 60W irons, made in Sweden and featuring iron-coated bits.

In order to keep the temperature of an iron down when it is not being used for long periods, it is the practice in some workshops to operate a half-heat arrangement, whereby a lamp is switched in series with the iron. The temperature will gradually rise to not far short of the correct operating level, then when the iron is needed, the lamp is switched out and the temperature comes up within a few seconds. Another method is to stand the iron on a large chunk of metal which keeps it from overheating by conduction. An old speaker magnet is sometimes used for the purpose, as this also attracts the iron and keeps it in place.

The Sinclair Cambridge... no other calculator is so powerful and so compact.

Complete kit - £24.95! (PLUS VAT)

The Cambridge - new from Sinclair

The Cambridge is a new electronic calculator from Sinclair, Europe's largest calculator manufacturer. It offers the power to handle the most complex calculations, in a compact, reliable package. No other calculator can approach the specification below at anything like the price - and by building it yourself you can save a further £5.50!

Truly pocket-sized

With all its calculating capability, the Cambridge still measures just $4\frac{1}{2}'' \times 2'' \times \frac{11}{16}''$. That means you can carry the Cambridge wherever you go without inconvenience - it fits in your pocket with barely a bulge. It runs on ordinary U16-type batteries which give weeks of life before replacement.

Easy to assemble

All parts are supplied - all you need provide is a soldering iron and a pair of cutters. Complete step-by-step instructions are provided, and our service department will back you throughout if you've any queries or problems.

The cost? Just £27.45!

The Sinclair Cambridge kit is supplied to you direct from the manufacturer. Ready assembled, it costs £32.95 - so you're saving £5.50! Of course we'll be happy to supply you with one ready-assembled if you prefer - it's still far and away the best calculator value on the market.



Features of the Sinclair Cambridge

- * Uniquely handy package.
 $4\frac{1}{2}'' \times 2'' \times \frac{11}{16}''$, weight $3\frac{1}{2}$ oz.
- * Standard keyboard. All you need for complex calculations.
- * Clear-last-entry feature.
- * Fully-floating decimal point.
- * Algebraic logic.
- * Four operators (+, -, x, ÷), with constant on all four.
- * Constant acts as last entry in a calculation.
- * Constant and algebraic logic combine to act as a limited memory, allowing complex calculations on a calculator costing less than £30.
- * Calculates to 8 significant digits, with exponent range from 10^{-20} to 10^{79} .
- * Clear, bright 8-digit display.
- * Operates for weeks on four U16-type batteries. (MN 2400 recommended.)

A complete kit!

The kit comes to you packaged in a heavy-duty polystyrene container. It contains all you need to assemble your Sinclair Cambridge. Assembly time is about 3 hours.

Contents:

1. Coil
2. Large-scale integrated circuit
3. Interface chip
4. Thick-film resistor pack
5. Case mouldings with buttons, window and light-up display in position
6. Printed circuit board
7. Keyboard panel
8. Electronic components pack (diodes, resistors, capacitors, transistor)
9. Battery clips and on/off switch
10. Soft wallet

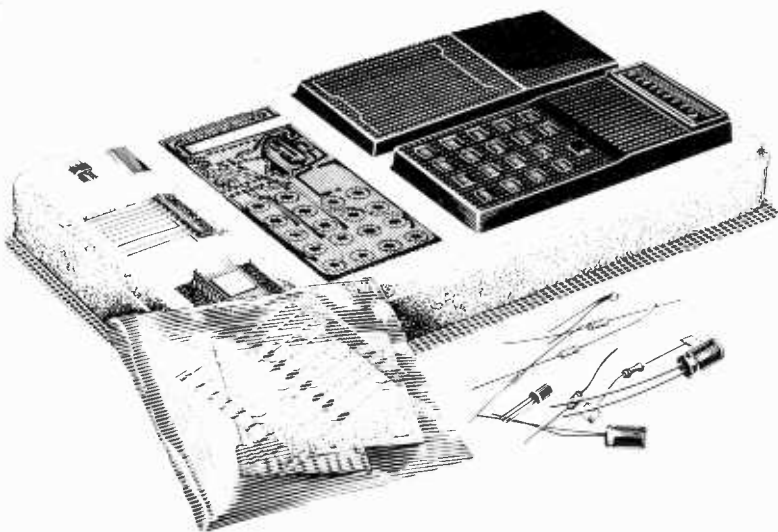

This valuable book – free!

If you just use your Sinclair Cambridge for routine arithmetic – for shopping, conversions, percentages, accounting, tallying, and so on – then you'll get more than your money's worth.

But if you want to get even more out of it, you can go one step further and learn how to unlock the full potential of this piece of electronic technology.

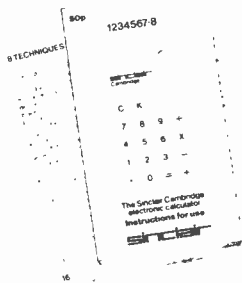

How? It's all explained in this unique booklet, written by a leading calculator design consultant. In its fact-packed 32 pages it explains, step by step, how you can use the Sinclair Cambridge to carry out complex calculations like:

- Logs
- Sines
- Cosines
- Tangents
- Reciprocals
- nth roots
- Currency conversion
- Compound interest
- and many others...

sinclair

Sinclair Radionics Ltd, London Road,
St Ives, Huntingdonshire
Reg. no: 699483 England
VAT Reg. no: 213 8170 88

Why only Sinclair can make you this offer

The reason's simple: only Sinclair – Europe's largest electronic calculator manufacturer – have the necessary combination of skills and scale.

Sinclair Radionics are the makers of the Executive – the smallest electronic calculator in the world. In spite of being one of the more expensive of the small calculators, it was a runaway best-seller. The experience gained on the Executive has enabled us to design and produce the Cambridge at this remarkably low price.

But that in itself wouldn't be enough. Sinclair also have a very long experience of producing and marketing electronic kits. You may have used one, and you've almost certainly heard of them – the Sinclair Project 60 stereo modules.

It seemed only logical to combine the knowledge of do-it-yourself kits with the knowledge of small calculator technology.

And you benefit!

Take advantage of this money-back, no-risks offer today

The Sinclair Cambridge is fully guaranteed. Return your kit within 10 days, and we'll refund your money without question. All parts are tested and checked before despatch – and we guarantee a correctly-assembled calculator for one year.

Simply fill in the preferential order form below and slip it in the post today.

Price in kit form: £24.95 + £2.50 VAT. (Total: £27.45)

Price fully built: £29.95 + £3.00 VAT. (Total: £32.95)

To: Sinclair Radionics Ltd, London Road,
St Ives, Huntingdonshire, PE17 4HJ

PW 1273

Please send me

Name

a Sinclair Cambridge calculator kit at
£24.95 + £2.50 VAT (Total: £27.45)

a Sinclair Cambridge calculator ready
built at £29.95 + £3.00 VAT
(Total: £32.95)

Address

*I enclose cheque for £ made
out to Sinclair Radionics Ltd, and
crossed.

*Please debit my *Barclaycard/Access
account. Account number

*Delete as required.

PLEASE PRINT

Because of the limitations of the 25- to 40 watt iron, most workshops have at least one or two other types and sizes of iron available. For larger jobs, an iron with a rating of 60 to 100 watts is required. These irons are similar to their smaller counterparts in general construction and appearance except for the size and element rating. The bit may be square instead of the usual pencil-type. As only occasional use would be expected, the iron would not normally be left on for long periods, so there would be no overheating problems.

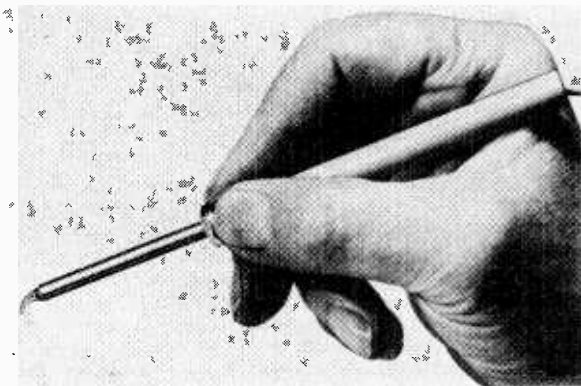

Work on integrated circuits requires a very small iron such as the Micro Soldering Pencil, shown here.

For the smaller and more intricate jobs, there are irons that are little bigger than pencils with element ratings of 10 to 15 watts. These are ideal for some of the tiny printed circuits that are now encountered and for the wiring of I.C.'s where the connections are close and damage could be caused by excessive heat. Heat output is obviously limited and many larger jobs could not be tackled. The element wire for these mains-operated low-wattage irons is necessarily very fine and so they are less reliable than the higher-rated ones. They should not be run continuously but only when a particular job calls for their use. Because of their small bit size, they are usually quite fast in warming up. This and their size also makes them suitable for outside service work.

LOW VOLTAGE IRONS

Another type which has achieved a measure of popularity is the low-voltage iron. While these can be run from a low-voltage source such as a car battery, the more common method is to operate them from a mains transformer. The main feature is a very quick heating time, just a matter of seconds, and a rapid heat-recovery time. This means that the iron can be used for outside service work where delays waiting for a conventional iron to warm up are thus eliminated.

One type of low-voltage iron is constructed very similarly to the normal iron and fed from a separate transformer, which also serves as an iron-rest. Other types have the transformer built-in, either over the top of a pistol-grip handle, or in one make, actually inside the handle. With these the element is also the bit, consisting of a loop of wire connected across the transformer secondary, Fig. 1.

In either of these low-voltage types, the bit can very quickly become overheated, even when being used on large areas, so a switch is incorporated in the iron so that the operator can keep switching it on and off and thereby maintain the tool at about the

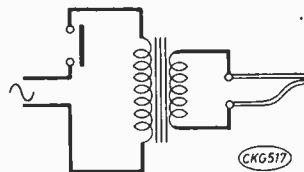

Fig. 1: Circuit of a transformer iron with element/bit consisting of a wire loop.

right temperature. In one make that uses a separate transformer, a thumb ring is used as a switch on the handle; while most of the built-in types, being pistol-like in construction, use a trigger switch.

This need for constant switching can be a drawback, especially if the switches are stiff as some are, and need considerable finger pressure. The danger of overheating due to switching on for too long can also be a hazard for transistors and other semiconductor devices.

A yet further drawback of the built-in transformer type is their weight. This is of little consequence for occasional use, but when used continuously, as in the professional workshop, they can be very tiring. The wire-loop bits are not very durable and need frequent replacement; while owing to their flexibility they cannot be used to unpick joints as can the conventional bit.



A pistol-grip soldering gun with integral transformer. The Welwyn KL3000.

The separate transformer type of low-voltage iron is therefore the more convenient, but for outside work the built-in type is probably the best. Neither though, really is as suitable as the mains-voltage type for workshop use.

CONTROLLED TEMPERATURE

Of recent years we have seen several thermostatically controlled irons which overcome some of the snags inherent with the uncontrolled types, whether high or low voltage. One, rather ingeniously, uses the Curie effect of iron. Iron, when it is heated beyond a certain point loses its magnetic properties. A small

iron disc is fixed to the base of the soldering-iron bit and this has an attraction for a bar magnet which holds a switch in the 'on' position by means of a push-rod, Fig. 2. When the iron temperature reaches the Curie point of the disc, it loses its attraction, the magnet is released and the switch is opened. As the temperature drops to below the Curie point, attraction is re-established and the switch returns to the 'on' position.

Each bit has its own iron disc, which can be made with different Curie points, hence with its own temperature setting. This particular iron is a low voltage model and is operated from a separate transformer. It has a very rapid warm-up time and good heat recovery, but, because of being thermostatically controlled, does not overheat nor need switching attention by the operator. The barrel is a little short though, for some types of work.

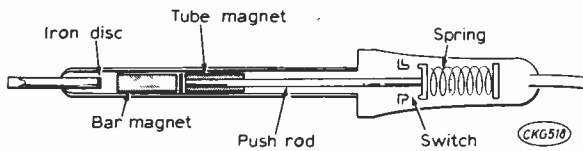

Fig. 2: Mechanism of a heat-controlled iron using the Curie effect.

Another thermostat iron is called the 'Litestat.' This is a mains-operated instrument, hence it is not encumbered with a transformer, either built-in or attached by lead. It has a 70 watt rating, but is only little larger than the average 25 to 40 watt instrument, the thermostat preventing it overheating. As with other thermostat irons, when there is a heavy outflow of heat from the bit due to working on a large heat conductive area, any loss of temperature is compensated by the switch remaining on longer than usual, and the larger element quickly supplies the extra heat volume. Thus we have the best of both worlds, a moderate sized iron that will handle reasonably small jobs (quite small if the extra-small bit is used) and will also tackle the big ones. Although the occasional user will probably get on quite well with a normal uncontrolled iron, the advantages of the thermostat control really make this type of iron a 'must' for professional workshops.

These then are the basic types of soldering instrument and their respective features. Within each category there are many makes and models and engineers and hobbyists alike often have a particular favourite that handles well and seems to produce good work for them.

SOLDERING BITS

Bits are available in several types. There are of course the various shapes and sizes that are produced for specific applications, most irons having a number of alternative bits obtainable as extras. There are though, differences in material. The most common is copper, which because of its high heat conduction is the best material (excluding precious metals) for the purpose. When clean it can be tinned quickly and easily, another great advantage. A disadvantage with copper bits is their deterioration with use. Prolonged periods of operation at high temperatures causes oxidization and flaking of the metal. In

addition, at the bit face where the solder is melted, cavities begin to form due to the chemical affinity of solder for copper, which absorbs it each time the bit is used.

Little can be done to stop the flaking other than running the iron at a lower temperature during standby periods, but the cavities can be almost eliminated by using the Savbit solder developed by Multicore. This contains minute traces of copper which satisfies the affinity of the solder without it taking more from the bit.

Other types of bit are made from alloys, or are nickel or chromium plated to achieve longer life. One method used by some manufacturers is to clad the copper bit with iron which is harder and more durable than copper, yet has the copper core for its thermal properties. A disadvantage with all these bits is that they cannot be filed without ruining them, thus once the plating or cladding has gone the bit must be discarded, whereas a copper bit can be filed flat at its face many times before filing and flaking reduces the size to inoperative proportions.

The superior thermal qualities and ease of tinning make the copper bit still the favourite, especially since its life can be prolonged with special solders.

USING THE IRON

Now just a point or two on using the iron. It is surprising the number of people who are technically well qualified, professional engineers included, who cannot seem to produce a good soldered joint. It is very important to do so, as all sorts of faults can arise from poor soldering. It is noteworthy that all candidates for the RTEB servicing exams had to undergo soldering tests and failure led to automatic disqualification for the whole of the practical and theoretical examinations.

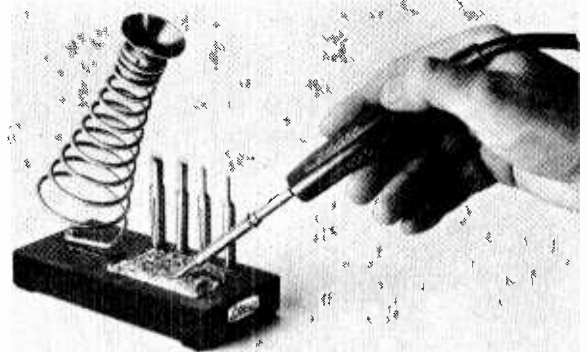

Litesold Conqueror iron and stand with bit-cleaning sponge and range of interchangeable bits.

There is nothing really difficult in making a good joint, just observing a few straightforward rules. The first one is to make sure that both surfaces are clean. In the case of wires, this can be done by pulling the wire a couple of times through the blades of a pair of side-cutters, as though one were stripping insulation. Terminals and tags can be scraped with a screwdriver blade. In most cases wires and terminals will be already tinned, but do not rely too much on it. Next both surfaces should be tinned. This is done by applying the iron to the surface for a few seconds, and then introducing the solder to bit and

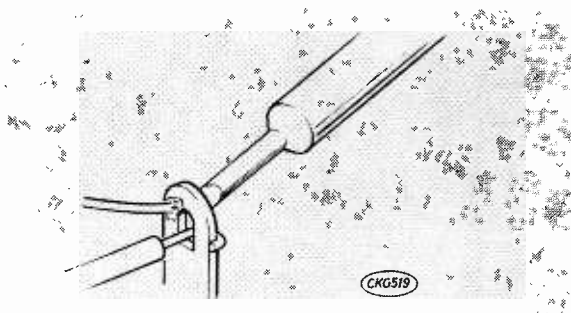

Fig. 3: The iron should heat the whole joint—not just the solder.

surface so that it runs easily over it, Fig. 3. If the solder is thick and slow to run, the bit temperature is too low, either because the iron has not been switched on long enough, or the iron is too small for the work. The solder may not run over the surface readily at first because insufficient heat has been transferred from the bit, and it is just not hot enough to melt the solder. This could be due to poor contact between bit and surface, but a little solder introduced at the junction of the two, will give a good thermal conduction, and the surface should then quickly attain sufficient temperature to itself melt solder when applied.

When both surfaces have been thus tinned, they are brought together in mechanical contact, and the iron applied again to both. More solder is then introduced so that it runs freely over both surfaces,

then the iron is withdrawn. Do not move the work until the solder has solidified otherwise a weak joint will result; this will take only a second or two. Where possible the joint should be mechanically sound before soldering. No external flux should be used as these are often corrosive and will give trouble in the future. Sufficient of the correct type of flux is contained in the cores of solders intended for electronic wiring, to do the job.

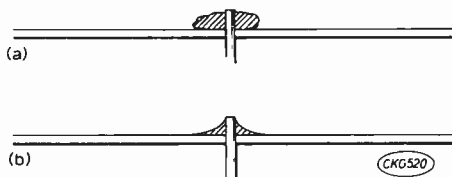

Fig. 4: (a) A 'dry' joint, showing the blob of solder due to insufficient heat or dirty surfaces.
(b) A good joint, showing smooth flow of solder over joined surfaces.

Do not use too much solder as this is not only unnecessary but could form a short to adjacent terminals. In appearance, the joint should be bright and smooth. A lumpy or pitted appearance shows the solder was not hot enough. It should also appear as a 'mound' rather than a blob. The illustration Fig. 4 shows what is meant by this. If the solder surface comes down and curls under as shown, it has not taken to the surface and we have a 'dry' joint. By observation of these points and a little practice, perfect joints can be made every time. ■

LETTERS—continued from page 742

Value for money

I greatly appreciated the article on 'Going Back' as it is full of nostalgia. I have taken P.W. off and on since the early beginnings, but only since 1967 have I bought it every month and I only started then because a free record of audio faults was given away, but on reading the articles on transistorised equipment, and particularly details of a transistor SW receiver by F. G. Rayer. I was astonished at the transformation in building techniques (being brought up on $\frac{3}{8}$ " thick breadboards and $\frac{1}{16}$ " dia. connecting wire!) and plunged up to the neck in transistor circuits and have been building them from P.W. projects ever since.

Though the price of P.W. has greatly increased, the contents have kept in step and I think it is still good value for money. It is improving all the time, as reference back to only a few years ago will show, and even in the last few months there have

been detailed improvements, such as better layout and the contents page being put on the first page. Long may you continue!

Incidentally, radio parts seem to be one of the few things which have not greatly increased in price, and some, like transistors and i.c.s, have actually gone down.—R. A. Read (Salisbury).

A Fly in the Ointment?

Do any readers know how to build an electronic fly-catcher? We are driven crazy with flies in the summer and we are sure that it is the sheep that bring them in.

I was born in the UK and lived many years in Africa but the flies were never as bad as here. I have taken P.W. for over 20 years now but have not seen any details of fly catchers. Also, we are a bit lost out here for getting components especially as we can only get a £2 British P.O. here on demand at the Post Office.—J. S. Skeels (One Tree Point, Rukaka, Northland, New Zealand).

Short Wave Converter

I have built the Radio Nederland converter, *Practical Wireless*, September 1973, and am very pleased with the results, however. I should like to point out an error in publication which would result in disappointment to those to quote your preamble—"with little experience in electronics."

Reference page 409 figure 1 circuit diagram oscillator Tr2 AF 124 and page 410 drawing AM0022. Note the emitter and base connections are shown reversed so there could be no conduction in the collector circuit due to reverse polarity at the base.

As a note of interest I used Wairite P coils either PA4 or PHF4 which very nearly approximate the coil data given for L1 and L2, a similar coil was slightly modified to make up L3. A PHF6 coil tuned by a 200pF silver mica in parallel with a 250pF trimmer was used for L4. The unit is used with a BUSH TR130 receiver tuned to the extreme h.f. end of the m.w. band.—A. J. Birkinshaw (Telford, TF2 6RA).

GOING QUADRAPHONIC

PW

Q4 PROJECT

PART 3 D. BOLLEN

- QS recordings
- SQ recordings
- Discrete CD-4 recordings
- SURROUND SOUND

THE article last month gave circuit descriptions of single and multi-system matrix decoders based on two circuit modules, Units A and B. There now follows constructional details of these two units, and of the additional units and components needed to build a multi-system decoder with infinitely variable front and back separation.

Readers are reminded that they will require, in addition to the decoder, a stereo outfit plus a pair of back amplifiers and speakers for quadraphonic reproduction from discs and tapes.



Unit A construction

Unit A is assembled on a piece of 0.1in. pitch Veroboard 0.9in. wide by 4in. long, see Fig. 16. Begin by making breaks in the copper strips, where shown, with a spot face cutter, and then insert and solder the terminal pins.

During assembly, it is important to ensure that the transistors are not overheated as this could have a detrimental effect on noise performance. A clip made of aluminium sheet should serve to conduct away heat when placed around the transistor can during soldering. Constructors who are not accus-

tomed to 0.1in. Veroboard should also make sure that solder blobs do not bridge between the copper strips. It is a good idea to run a sharp knife blade along the gaps between strips to remove excess flux and any particles of solder. When inserting capacitors in the unit A circuit board, check that the polarity is as shown in Fig. 16.

Note: all exposed wiring must be sleeved

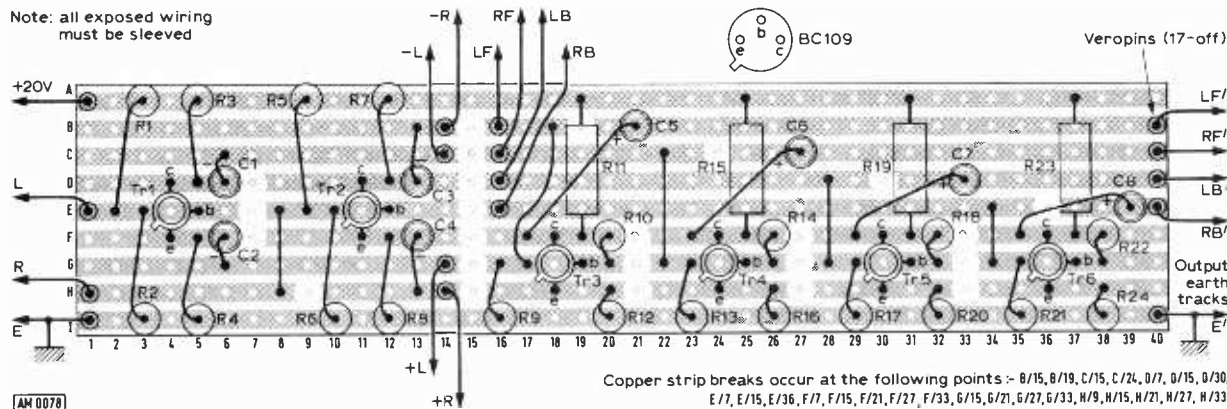
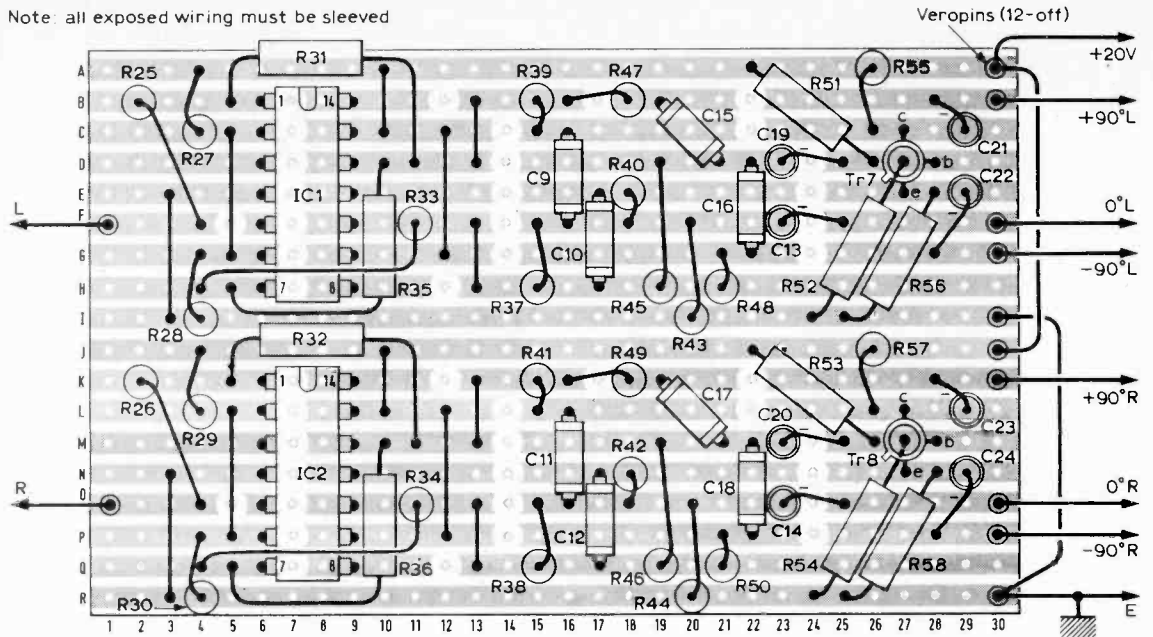

Fig. 16: Component layout of unit A circuit board. Note breaks in copper strips.

Note: all exposed wiring must be sleeved



AM 0079

Copper strip breaks occur at the following points:-

B/7, B/12, B/17, B/22, C/7, C/14, C/22, D/7, D/14, D/24, E/7, E/14, E/24, F/5, F/7, F/14, F/24, G/7, G/14, G/24, H/7, H/12, K/7, K/12, K/17, K/22, L/7, L/14, L/22, M/7, M/14, M/24, N/7, N/14, N/24, O/5, O/7, O/14, O/24, P/7, P/14, P/24, Q/7, Q/12.

Fig. 17 Component layout of unit B circuit board. Note breaks in copper strips.

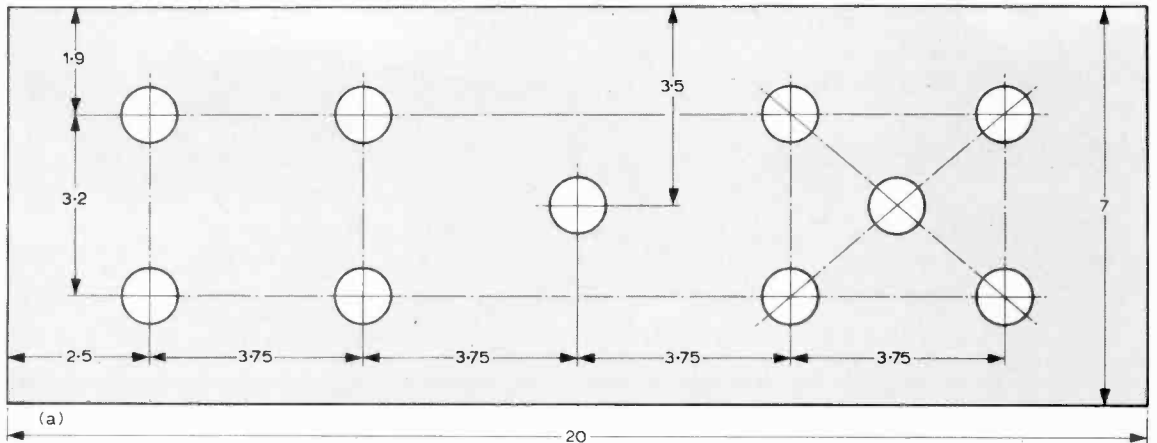

AM 0081

All dimensions in cm.

Drill all holes 1cm diameter

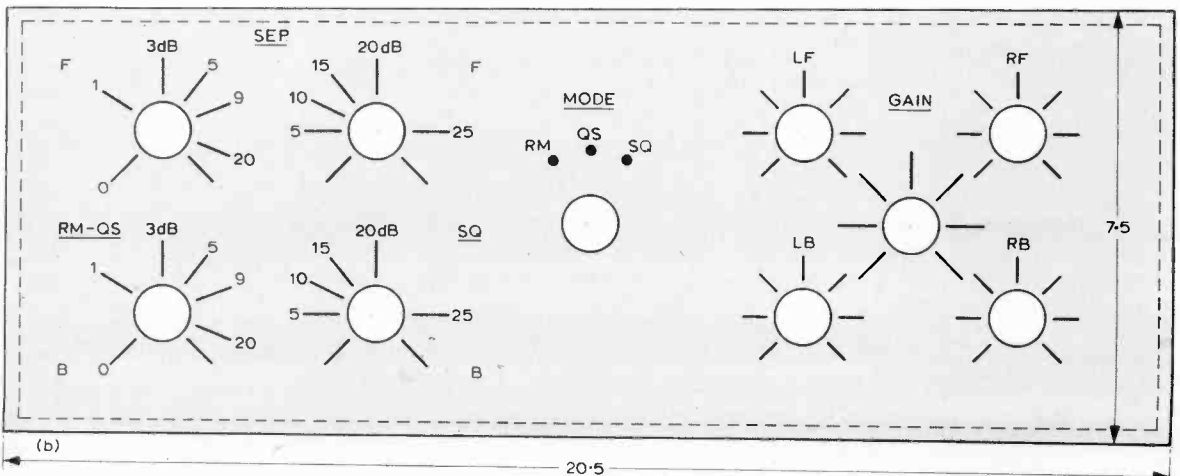

Fig. 18(a) Drilling details of front of chassis tray. Fig. 18(b) Front panel layout.

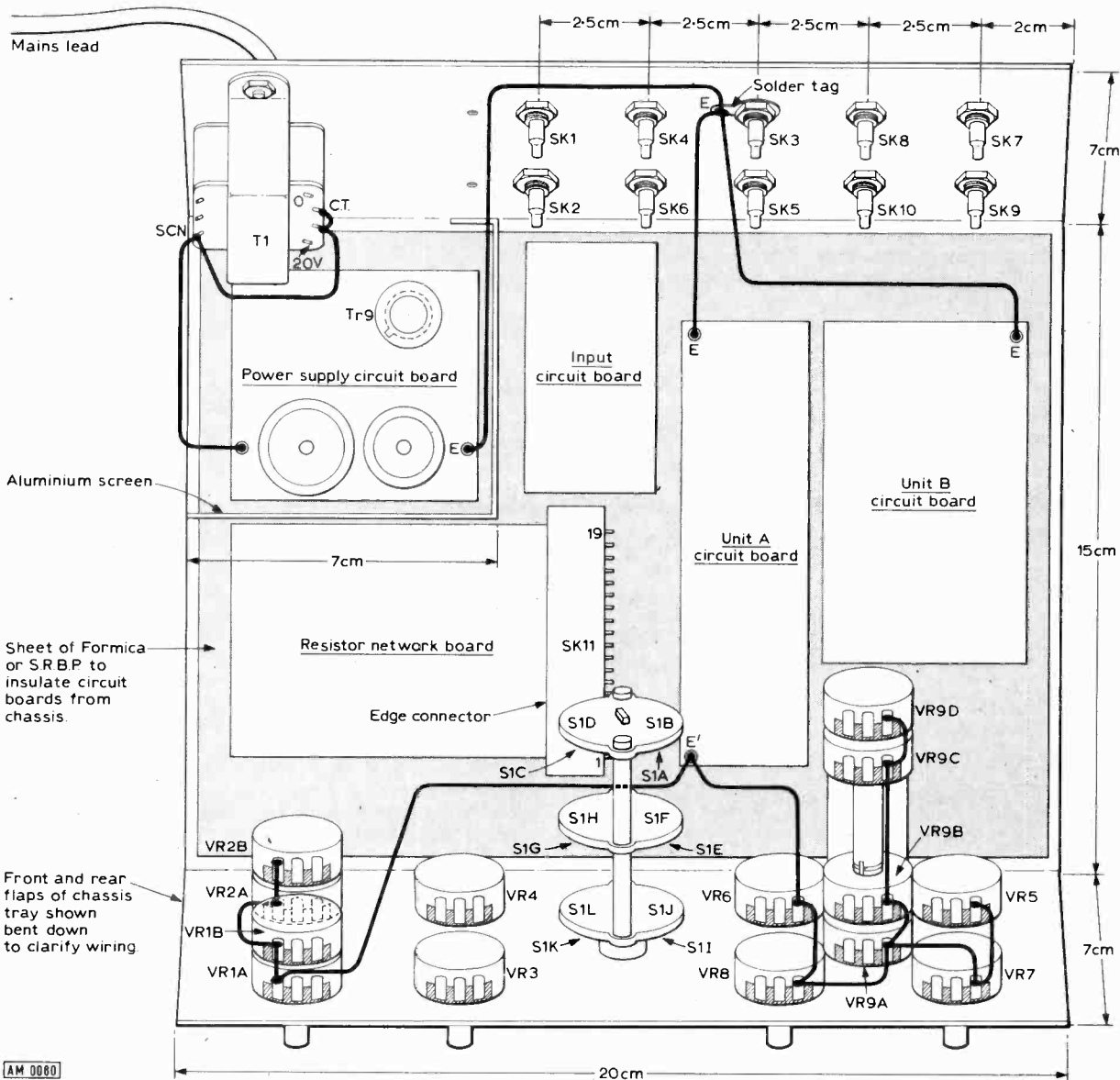

Fig. 19: Multi-system decoder layout showing earth wiring.

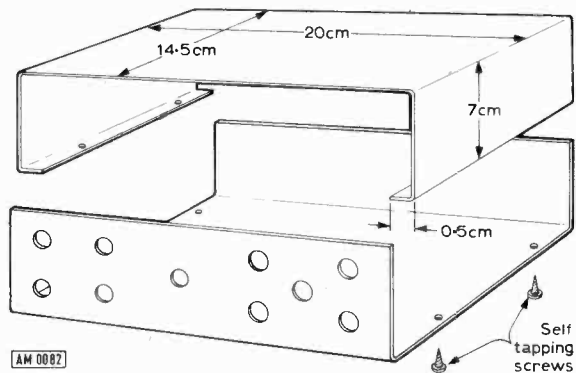

Fig. 20: Dimensions and fixing details of the chassis cover.

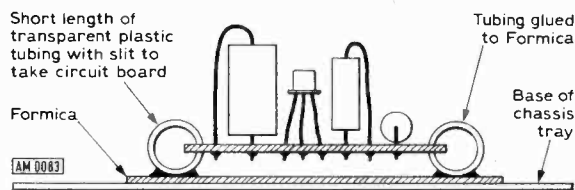

Fig. 21: A method of securing the circuit boards.

Unit B construction

A piece of 0.1in. pitch Veroboard 1.8in. wide by 3in. long is employed for unit B, and the layout is shown in Fig. 17. Left and right hand channels are identical and are arranged one above the other on the circuit board.

Make breaks in the copper strips according to the diagram of Fig. 17 and insert and solder all terminal pins. Commence with the ICs, leaving pins 3, 5, 8, 11, and 14 unsoldered, and then position and solder the remaining components. Use a heat clip on Tr7 and Tr8 and ensure that the polarity of the electrolytic capacitors is correct.

Small piece of 16 swg aluminium to engage in slot at the back of the front pots, and slot in the spindle.

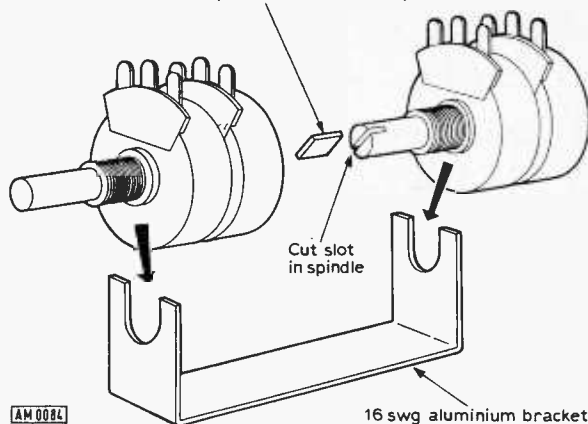

Fig. 22: VR9 assembly utilising two dual-gang potentiometers.

Checking units A and B

As a preliminary check, wire the earth and +20V terminal pins of unit A circuit board to an 18V battery (two PP9s in series) and with a testmeter measure the voltages between the earth terminal and the transistor cans. Tr1 and Tr2 should show a voltage of about 14V, and Tr3-Tr6 a voltage of 9V. If there is a serious discrepancy, look for a short circuit between the copper strips on the underside of the circuit board, or an error in component positioning.

To check unit B, connect the 18V battery to earth and +20V terminals and measure the voltage at IC1 and IC2 pins 10 and 12, which should be at 9V relative to the earth terminal pins. The can voltage of Tr7 and Tr8 will be about 14V if there are no constructional faults.

If the user intends to experiment with a single-system decoder, units A and B can be employed with an 18V battery, or the power supply of Fig. 15, with 22kΩ balance controls (VR5-VR8 Fig. 14) wired to the LF, RF, LB, and RB outputs of unit A. It is advisable to connect a 1000μF 25V electrolytic capacitor across the supply rails when operating units A and B from a battery.

Where an oscilloscope with X-Y facilities is available, unit B can be tested for 90° phase shifting by injecting a signal of 2kHz into the left input, with the X input of the scope linked to the 0°L output, and the Y scope input connected to each of the 90°L outputs in turn. The resulting display should be a near perfect circular trace. Repeat the test for the right hand channel.

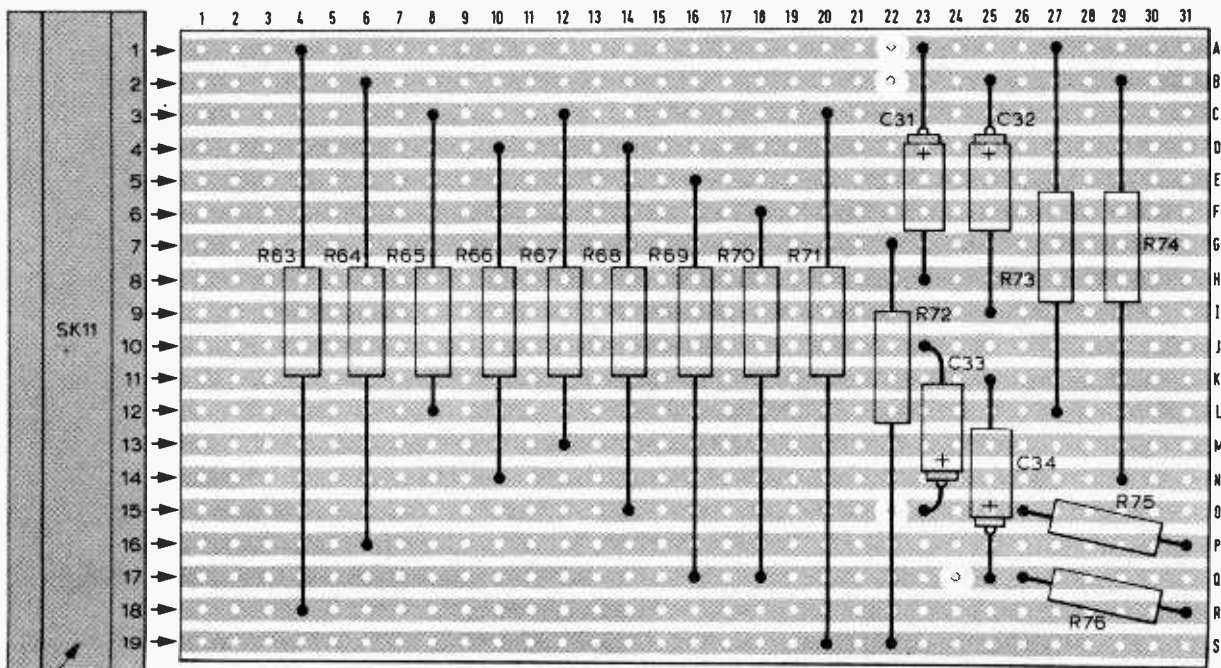

Edge connector

AM 0085

Copper strip breaks occur at the following points:- 0/24, 0/22, 8/22, A/22.

Fig. 23: Component layout of resistor network board.

THE SPECIALISTS IN QUADRAPHONIC KITS

AVAILABLE NOW!

THE COMPREHENSIVE KIT FOR THE

P.W. Q4 PROJECT

SEND NOW FOR FULL DETAILS AND PRICES—SEE COUPON BELOW

FULLY COMPREHENSIVE HOME CONSTRUCTOR KITS AS SPECIFIED
IN THE PRACTICAL ELECTRONICS

P.E. RONDO

COMPLETE QUADRAPHONIC HI-FI SYSTEM

CBS SQ (TM CBS INC.) MATRIX DECODER. COMPLETE KIT	£8.00 Post Free + 80p V.A.T. Inc. CBS Licence Fee
PRE AMPLIFIER BOARD. COMPLETE KIT	£3.00 Post Free + 30p V.A.T.
MASTER VOL./TONE/4 CH. BALANCE BOARD. COMPLETE KIT	£8.50 Post Free + 85p V.A.T.
POWER AMP. BOARD & HEAT SINKS (STEREO PAIR). COMPLETE KIT	£7.50 Post Free + 75p V.A.T.
POWER SUPPLY BOARD. COMPLETE KIT	£5.00 Post Free + 50p V.A.T.
MAIN SMOOTHING CAPACITORS	£0.75 Post Free + 7p V.A.T.
MAINS TRANSFORMER. COMPLETE	£6.25 Post Free + 62p V.A.T.
CHASSIS. PUNCHED & DRILLED	£2.25 Post Free + 22p V.A.T.

ALL KITS ARE FULLY TO SPECIFICATION AND COMPLETE IN EVERY
DETAIL. TRADE ENQUIRIES WELCOME

STUDIO ELECTRONICS

P.O. BOX 18,
HARLOW, ESSEX, CM18 6SH

Please send me:

CBS SQ DECODER
PRE AMPLIFIER BOARD
MASTER VOL. BOARD
POWER AMP. BOARD
POWER SUPPLY BOARD
SMOOTHING CAPACITORS
MAINS TRANSFORMER
CHASSIS
P.W. Q4 PROJECT Full Details

Block capitals please

NAME

ADDRESS

..... P.W.12

Please tick box

MONEY ENCLOSED

£

CHEQUE/P.O./
MONEY ORDER

ESSENTIAL BOOKS FOR RADIO AMATEURS

1974 EDITION

RSGB AMATEUR RADIO CALL BOOK

Lists holders of G, GC, GD, GI, GM, GW and EI call signs; clubs and societies affiliated to RSGB, and much useful operating information.

A larger completely revised edition produced by a new system and incorporating amendments and additions notified by the MPT up to August 1973.

144 pages

Price 75p post paid

RADIO AMATEURS' EXAMINATION MANUAL

by G. L. Benbow, G3HB

The standard book for all would-be licensed radio amateurs studying for the Radio Amateurs' Examination.

Fully up-to-date to meet the present examination syllabus requirements.

96 pages

Price 90p post paid

A GUIDE TO AMATEUR RADIO

by Pat Hawker, G3VA

This extensively revised 15th edition is an indispensable aid to all who want to know more about amateur radio.

Specially designed to assist the newcomer to the hobby.

96 pages

Price 90p post paid

AMATEUR RADIO AWARDS

by C. R. Emery, G5GH

Lists all the world's major awards from national societies and how to obtain them.

Includes reproductions of certificates and maps, and operating information.

Loose-leaf binding allows insertion of amendment pages at a later date.

194 pages

Price £1.40 post paid

These are just four of a complete range of technical publications, log books and maps for the radio amateur. Send a large s.a.e. for the complete list.

The RSGB is the national society representing all UK radio amateurs. Membership is open to all interested in the hobby: write to the General Manager and ask for full details.



RADIO SOCIETY OF GREAT BRITAIN

35 DOUGHTY STREET, LONDON, WC1N 2AE TEL: 01-837 8688

4-STATION INTERCOM



£8.75

Solve your communication problems with this 4-Station Transistor Intercom system (1 Master and 3 Subs), in de-luxe plastic cabinets for desk or wall mounting. Call/talk/listen from Master to Subs and Subs to Master. Ideally suitable for Business, Surgery, School, Hospital, Office and Home. Operates on one 9V battery. On/off switch. Volume control. Complete with 3 connecting wires each 66ft. and other accessories. P. & P. 47p

MAINS INTERCOM NEW MODEL

No batteries - no wires. Just plug in the mains for instant two-way, loud and clear communication. On/off switch and volume control. Price £18.95 P. & P. 60p

INTERCOM/BABY ALARM



OUR PRICE ONLY £4.85

Name as 4-Station Intercom for two-way instant communication. Ideal as Baby Alarm and Door Phone. De-Luxe Model complete with 66ft. connecting wire. Complete with Battery. P. & P. 35p

Transistor TELEPHONE AMPLIFIER



£4.25

Why not boost business efficiency with this incredible De-luxe Telephone Amplifier. Take down long telephone messages or converse without holding the handset. A useful office aid. On/off switch. Volume Control. Complete with Battery. P. & P. 27p. Full price refunded if not satisfied in 7 days.

WEST LONDON DIRECT SUPPLIES (PW.12)
189 KENSINGTON HIGH STREET, LONDON, W.8.

0442:62757

THE NUMBER FOR CLOCKS, LSI CHIPS, KITS & DISPLAYS.

Choose a combination from the tables below, get out your Access card and ring the above number, or send us a cheque, MO, PO, etc.

BYWOOD for ADVICE, SERVICE and of course COMPONENTS.

Clock Code	12/24 Hour	4/16 Digit	BCD out	7seg out	MPX'd	1Hz out	AM/PM	Alarm	Date	Snooze	Sleep	Pn Cnt	INTERFACES						Availability	PRICE		
													TIL360	DL34	DL707	DL62	DG12	TAB055			Drive	Volts
MM5311	Y	Y	Y	Y	Y	Y	Y	Y	Y	Y	Y	28	D	D	T	T	-	11-19	8		Stock	11.50
MM5314	Y	Y	Y	Y	Y	Y	Y	Y	Y	Y	Y	24	D	D	T	T	-	11-19	8		3 Days	11.00
MM5316	Y	4	Y	Y	Y	Y	Y	Y	Y	Y	Y	40	-	-	-	D	K	8-29	4		Stock	16.00
5017AA	Y	6	Y	Y	Y	Y	Y	Y	Y	Y	Y	24	T	T	T	K	-	11-18	16		Stock	14.00
5017BB	Y	6	Y	Y	Y	Y	Y	Y	Y	Y	Y	24	T	T	T	K	-	11-18	16		Ltd	14.00
CT 7001	Y	6	Y	Y	Y	Y	Y	Y	Y	Y	Y	28	T	T	T	D	-	11-18			Feb74	18.00

Display Code	Type	Pack	Digs	Digit Size	Drive Req.	Common	Digit Cost £	Unit Cost £
TIL360	LED	16 DIL	6	0.1ins	2v 10mA	Cathode	2.50	15.00
DL707	LED	14 "	1	0.3ins	3v 30mA	Anode	2.00	2.00
DL34	LED	14 "	4	0.1ins	5v 10mA	Cathode	2.50	10.00
DL62	LED	16 "	1	0.6ins	6v 30mA	Anode	6.50	6.50
DG12H	Phosphor Diode	TUBE	1	12.5mm	25v 1mA	Htr Anode	2.00	2.00
TAB055	Liq Cryc.	EDGE	4	0.6ins	30v125uA (A.C.)	N/A	3.25	13.00

Sockets - 24 or 28pin 115p, 40 pin 135p. Case - Warm red Perspex 250p.

Kits 5017AA or BB + PCB + socket + 4 DG12s + Instructions £24.
MM5316 + " + " + TAB055 + " £32.

CLOCK DATA SHEETS - SAE. ADVICE - PHONE 0442 62757 CATALOGUE 15p
POST & PACKING - 10p. OVERSEAS (AIRMAIL) 50p. VAT - ALL PRICES EXCLUDE VAT.
PAYMENT C.W.O. or ACCOUNT. ACCESS. ORDERS & PAYMENT BY PHONE ACCEPTED.
QUANTITY DISCOUNTS ON MOST ITEMS - STATE REQUIREMENTS FOR QUOTATION.

BYWOOD

Bywood Electronics
181 Ebbens Road
Hemel Hempstead
HP3 9RDA

Multi-system decoder construction

Fig. 19 shows the layout of a multi-system decoder based on the circuit of Fig. 14. Additional circuit boards serve to accommodate the resistor network, input capacitors and resistors, and power supply components; these will be described later.

A start can be made by making up the chassis tray from 16s.w.g. aluminium sheet, to the measurements shown in Fig. 19. Allow 7cm of space for the power supply, and mark out and drill the rear of the chassis tray to take sockets SK1-SK10. Next, mark out and drill the holes to mount transformer T1, the power supply screen, and mains lead grommet.

Drilling details for the front of the chassis tray are given in Fig. 18a, and Fig. 18b shows a front panel made of 20.5cm by 7.5cm brushed aluminium or white Formica, which is drilled to match the holes in the chassis tray. The dimensions and fixing details of the chassis cover are shown in Fig. 20.

Glue a sheet of Formica or s.r.b.p. inside the base of the chassis tray to insulate the circuit boards from the chassis; this should measure 19cm by 14.5cm. A method of securing the circuit boards is shown in Fig. 21.

Make up switch S1 from three 4-pole 3-way wafers, with a three spacer gap between wafers. Mount the assembled switch on the front of the chassis tray, along with controls VR1-VR8.

In the absence of a four-gang component for VR9, this can be made up from two dual-gang potentiometers, as shown in Fig. 22. A small piece of sheet aluminium engages with the spindle slot at the rear of the front pair of pots, and with a slot in the

spindle of the back pots. To align VR9, set the front pots to mid-track and measure the resistance between a slider and the earthed end of its track. Rotate the body of the rear pots to give a similar resistance reading on a rear pot slider and its track end, and then tighten the mounting nuts. VR9 can now be mounted on the chassis.

Resistor network board

The resistor network components are assembled on a piece of 0.1in. pitch Veroboard 1.9in. wide by 3.1in. long, and this is designed to plug into a 19-way edge connector (SK11) to facilitate easy modification of matrix parameters. The layout of the resistor network board is shown in Fig. 23.

A suitable edge connector, such as the RS Components 0.1in. 25-way, may be cut down to 19 ways with a small saw. When the resistor network board is completed it can be inserted in SK11, and the latter glued to the insulating board on the chassis tray.

Input circuit board

Fig. 24 shows the input circuit board with components mounted on 0.1in. Veroboard, which measures 2in. wide by 1.2in. long.

In Fig. 14 (last month) the lower unit board should have been designated unit B. We regret, that due to pressure on space, final constructional details, wiring and setting up, have had to be held over until next month.

TO BE CONTINUED

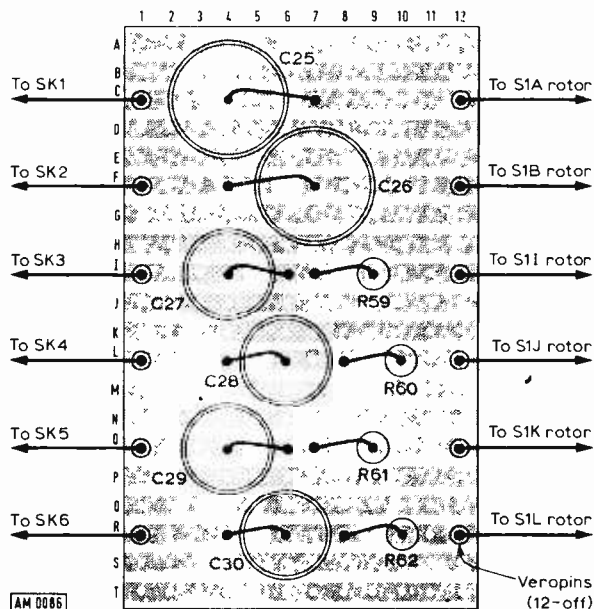

Fig. 24: Component layout of input circuit board.

COMING SOON

Q4 MATRIX MATE

For any quadraphonic matrix decoding system.

Watch for further details!

TAKE 20

DAVID ANDREWS

No. 55

TRIPLEX SIGNALLING UNIT

A series of simple transistor projects, using not more than twenty components.

THIS project can be used as quite a useful gadget for signalling between the house and a shed or to illuminate signs outside an office door. Signals are produced by two lamps either, or both, of which can be switched on and off. This does not, in itself, sound very clever but the circuit to be described enables one to do this with a single pair of wires. Thus, over two wires one can display three separate codes on the two lamps.

Circuit

The trick is to make use of positive going half cycles of the mains supply to switch on one lamp. In Fig.1 D6 is forward biased for positive going cycles and LP2 will light but when SW2 is switched to the centre position the polarity of these half cycles is reversed and D5 becomes forward biased, turning on LP1 (D6 becomes reverse biased and LP2 goes out).

The third code, having both lamps on at the same time, is obtained by turning SW2 into the third position which applies a.c. to the signal wire pair direct from the transformer. LP1 and LP2 will now each light up, LP2 on positive and LP1 on negative half cycles.

Variations

There are many variations to this circuit, and relays could be used instead of the lamps. Provided limiting resistors were inserted into the lines and the voltage reduced to below the reverse breakdown level, light emitting diodes could be used instead of the lamps, diodes D5 and D6 being omitted. For those who do not wish to bother with a.c. and a transformer one can still transmit two codes down the pair of wires by dispensing with the control unit. All that is needed in its place is a suitable battery and a reversing switch on the control end of the signal wires. One polarity will turn on one of the lamps, reverse the polarity of the supply and the other lamp will light. Apart from the diodes most of the components can be

salvaged from old equipment. Any 6.3V transformer will do for T1 and probably the best source is an old valved radio.

Fig. 2 shows a suggested layout for the unit, on a metal or insulating material panel, which can be the lid of a box.

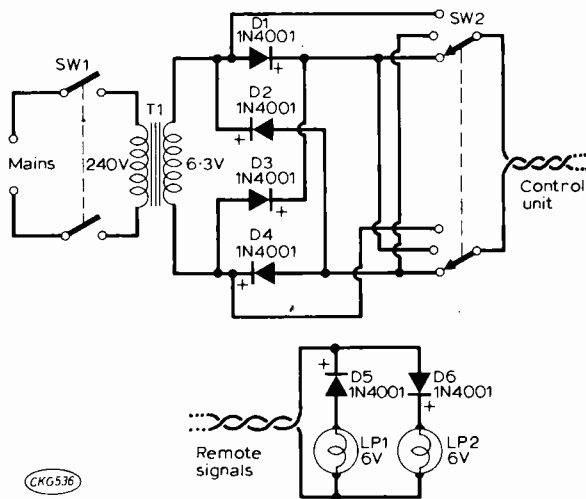

▲ Fig. 1. Circuits of Control Unit and Remote Signals

▼ Fig. 2. Author's suggested layout for the two units.

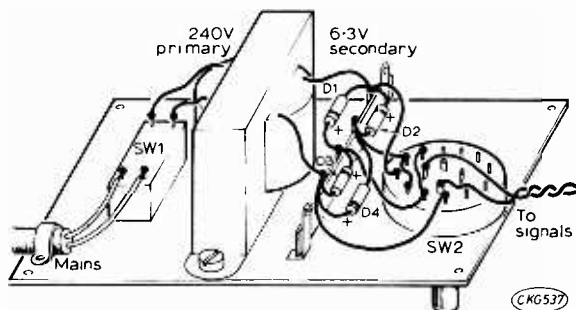

★ components list

D1-6	Diodes 1N4001
LP1-2	6V Lamps
SW1	2 pole mains switch
SW2	2 pole 3 way wafer switch
T1	Mains transformer, 240/6.3V
	Mounting box, tag strip, etc.

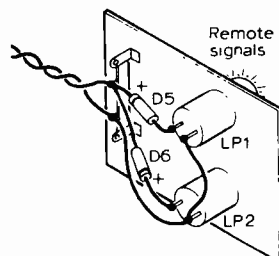



BROADCAST BANDS

MEXICO: XERMX has been heard in Spanish on 15195kHz at 0330 GMT, this is a change from the usual frequency of 15125kHz.

TUNISIA: Radio Tunis has been noted on 15226 kHz at 2345 GMT and at 0910 GMT on 11970kHz. (Some of the above items by courtesy of Sweden calling DXers.)

SHORT WAVE DX by MALCOLM CONNAH

As many of you will know, propagation conditions vary according to the time of day, the time of year and the position in the 11-year sunspot cycle; as well as other minor factors. This means that, at any particular time, there is an optimum band for reception from any part of the world.

Forecasting these optimum bands is a relatively simple matter once one has collected all the necessary information. The following forecast is for reception in Western Europe and is listed by transmitter site.

North America During the late afternoon the most suitable band will be 25 metres, by 1900 GMT this will have changed to 19 metres but will return to 25 metres by 2300. During the early hours of the morning the most useful frequency will drop still further reaching 31 metres by 0300.

Central & South America The optimum frequency during the late afternoon will be 16 metres and this will drop gradually during the evening to be 19 metres at 1900; 25 metres at 2300 and 49 & 60 metres at 0300.

Middle East The late afternoon finds 19 metres as the best band dropping to 31 metres at 1900 and 41 metres at 2300.

Far East & Australasia Reception for this area will be much the same as the Middle East except that the best band will not drop below 31 metres.

Africa Late afternoon reception will be best on 16 metres dropping to 25 metres at 2000 and 31 metres at 2300.

DX News

COSTA RICA: Radio Capital de Costa Rica has been heard on 4832kHz at 0130 GMT. Reception is poor due to the low power of 1 kW.

ECUADOR: Radio Nacional del Ecuador has been noted with a programme of news and Latin-American music on 6170kHz at 0500 GMT.

EL SALVADOR: La Voz del Comercio, Colonial Sta. Lucia, Santa Ana, is asking for reception reports on 9545kHz. The best time for reception being 1600 GMT.

Readers' Logs

John D. Porter of Bakewell (No jokes about Bakewell tarts—please) in Derbyshire has nine transistors and a few other components built into his superhet receiver. This, in combination with a 45 metre long-wire and some attention to the higher frequency bands, produced the following results:

- 11710 R. *Nacional d'España* at 0005.
- 15110 R. *Grenada, Windward Is.*, English at 2100.
- 15150 R. *Pyongyang, N. Korea* noted at 2030.
- 15375 *HCJB, Quito, Ecuador* at 2210.
- 15415 R. *Kuwait* in English at 1850.
- 15450 R. *Nacional de Brasilia* in English at 2355.
- 17820 R. *Canada Int.*, in Polish at 1540.
- 17885 *HCJB, Quito, Ecuador* noted at 2250.

Andrew Brown of Maidenhead in Berkshire is fourteen years of age so both his National HRO and R107 receivers are older than he is. The connection of a 10 metre long-wire antenna enabled the following stations to penetrate Andrew's shack:

- 7275 *RAI, Italy* in English at 1936.
- 9005 *Tehran, Iran* in English at 2000.
- 9560 R. *Jordan, Amman* in English at 1600.
- 9655 R. *Damascus, Syria* in English at 1930.
- 9745 R. *Baghdad, Iraq* in English at 1930.
- 11765 *Radio Australia* noted at 0710.
- 15165 R. *Denmark* in Danish at 0945.
- 15325 R. *Pakistan, Karachi* in English at 1530.
- 15520 R. *Bangladesh* in English at 1715.
- 17825 *NHK, Japan* in English at 0800.
- 21520 *RSA, South Africa* noted at 0755.
- 21655 R. *Norway, Oslo* in English at 2000.

David Thornley of Dukinfield, Cheshire has a Trio 9R59DS receiver and a Joystick antenna with ATU; which enabled him to hear:

- 7125 R. *Peking* in English at 0120.
- 9020 R. *Iran* in English at 2000.
- 9610 R. *Kiev* in English at 0030.
- 11672 R. *Pakistan* with news in English at 2000.
- 11880 *Voice of Turkey* in English at 2000.
- 15425 *Israel* with news in English at 1200.
- 17735 R. *Havana, Cuba* in English 2035.
- 21605 *RSA, South Africa* with quiz show at 1305.



MEDIUM WAVE BROADCASTS by CHARLES MOLLOY

ROY PATRICK (Derby) has been busy with his National 1400 receiver on the medium waves. He reports 'good reception of Radio London on 1457kHz and the two IBA London transmitters on 557kHz and 719kHz. While on a visit to Farnborough (Hants) Roy logged Radio Brighton 1484kHz, Radio London and Radio Solent on 998kHz.

Richard Livesey (Guildford) has used his Audio-tronic multiband receiver with internal ferrite aerial to hear Radio Portugal 755kHz at 2310hrs; Radio Prague 1286kHz; Trans World Radio Monte Carlo 1466kHz at 2230hrs; Radio Moscow 1493kHz at 2230hrs; Radio Warsaw 1502kHz at 2230hrs. All of these broadcast in English.

Ian Gordon (Birmingham) has a Codar CR70A receiver, a 25 metre longwire antenna and an aerial tuning unit (ATU). He reports hearing Radio Tirana 1394kHz with sign-on at 2000hrs; Radio Blackburn 854kHz; R. Leeds 1106kHz; R. Stoke 1502kHz; R. Nottingham 1520kHz; R. Bristol 1546kHz plus the American Forces Network in Germany on 611kHz (Grafenwohr / Kaiserslautern / Nürnberg), 872kHz (Frankfurt), 935kHz (Berlin), 1106kHz (Munich),

1142kHz (Bremerhaven/Stuttgart). The AFN can also be heard on 1034kHz (Karlsruhe), 1304kHz (Heidelberg), 1394kHz (Augsburg).

M. Laugharne (Didcot, Berks) reports hearing R. Solent 998kHz, R. London 1457kHz, R. Oxford 1484kHz and R. Bristol 1546kHz on his Philips portable receiver. T. D. Wilson (Hemel Hempstead) used a Grundig Mariner to hear R. Sweden 1178kHz and R. Portugal 755kHz, both in English at 2300hrs. He mentions receiving WINS, New York City on 1010kHz last February. Gary Celand (Southall, Middlesex) would like to listen to North American stations on the medium waves and when reception is possible. A path of darkness between transmitter and receiver is required for medium wave propagation. Listen for North Americans some five to six hours after sunset in the UK. From November to February they can be logged as early as 2330hrs when conditions are favourable. Those most frequently heard are CJON St. John's in Newfoundland on 930kHz; CHER Sydney, Nova Scotia on 950kHz; WINS New York City on 1010kHz; CBA Moncton, New Brunswick on 1070kHz and WNEW 1130kHz New York City.

The BBC have announced the location of the first four low power medium wave stations which will improve the Radio 4 service to the south-west of England. Torquay 854kHz (351m), Barnstaple 683kHz (439m), Plymouth 1457kHz (206m) should come into service before the end of 1973 and Redruth 755kHz (397m) by the Spring of 1974. The Barnstaple service will replace the present one on 692kHz (434m) while the others will be additional to the existing Radio 4 medium wave service.

VHF/FM DXING

by SIMON DAVID

T. J. Clamp of Cranbrook in Kent lists among other stations in the U.K., Markelo 2 on 98.4MHz and Roermond 1 on 88.3MHz, both from Holland, as well as Aalter, Belgium on 98.5MHz. He uses a Grundig Melody Boy 1,000 receiver and the in-built 86cm telescopic aerial. He also says "How about a list of BBC local radio station frequencies on f.m.?" Other readers have also asked for this information, so I have included it in this month's column. The BBC Engineering Information Department issues complete lists with frequencies, powers, and polarization on Information Sheets 1034(24) and 1919(21) for any one with a technical interest. In the not too distant future I shall be giving details of some of the European frequency allocations. Details on Radio Telefis Eireann were given last month.

Igor Hájek has given me some very interesting gen on East European bands. With reference to my comments in the September issue, he points out that East European countries (including U.S.S.R.) use the 65-73MHz band, possibly with a view to making it difficult for their local population to have access to Western broadcasts. In spite of this, Czechoslovakia have tuners that cover West Europe (CCIR) and East Europe (OIRT). How long before we have this facility as commonplace in the U.K.? (see Leader article—Ed.).

This lower frequency band is in the 4 metre area of the dial and does lend itself very well to DX reception, as my colleague David Gibson will testify.

Future plans for stereo on v.h.f./f.m. include Wenvoe and Kirk O'Shotts next year, Pontop Pike and Sandale (near Carlisle) in 1975. It is surprising that Norfolk and Huntingdon areas are not yet planned, especially in view of the flat terrain.

The following is a list of BBC Local Radio stations. Birmingham, Blackburn, Manchester and Teesside will have transmission powers increased. Slant polarisation is employed at Blackburn, Derby, Leeds, Leicester, Manchester, Nottingham, and Sheffield (main). All others use horizontal polarisation. Medium wave shown in brackets.

Birmingham 95.6MHz (206m)
Blackburn 96.4MHz (351m)
Brighton 95.3MHz (202m)
Bristol 95.5MHz (194m)
Carlisle 95.6MHz (397m, 206m)
Derby 96.5, 94.2MHz (269m)
Humberside 96.9MHz (202m)
Leeds 92.4MHz (271m)
Leicester 95.1MHz (188m)
London 94.9MHz (206m)
Manchester 95.1MHz (206m)
Medway 96.7MHz (290m)
Merseyside 95.8MHz (202m)
Newcastle 95.4MHz (206m)
Nottingham 95.4MHz (197m)
Oxford 95.2MHz (202m)
Sheffield 97.4, 88.6MHz (290m)
Solent 96.1MHz (301, 188m)
Stoke-on-Trent 96.1MHz (200m)
Teesside 96.6MHz (194m)



I.L.P. (Electronics) Ltd

SECOND GENERATION 25 WATT HYBRID

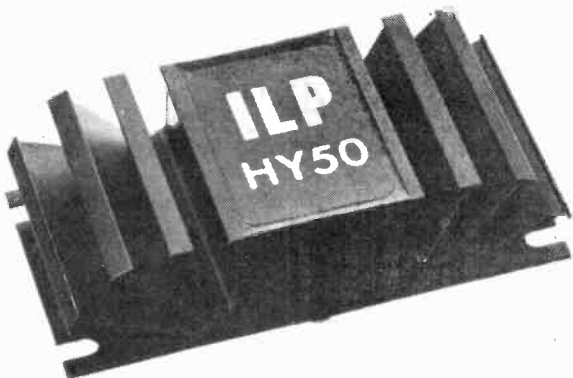

A brand new hybrid fabrication technique, recently perfected in our laboratories, has enabled us to achieve our latest range of completely integrated devices. We have now finally reduced the modular amplifier to a simple input/output device requiring only the addition of a basic unstabilized (split line) power supply. The HY50 takes medium power modules to their logical conclusion by incorporating with it a heatsink, which is designed in special high conductivity alloy, sufficient for normal audio use without additional chassis sinking. All this without significantly increasing the size of the module comparable in size to a packet of 'King-size' cigarettes.

Consistent with modern thinking a triple rated output circuit with a load fuse allows for peak transient response without distortion but ensures the necessary protection.

OUTPUT POWER:	SPEC.
LOAD IMPEDANCE:	25 watts RMS, 50 watts peak music power
INPUT SENSITIVITY:	4.16 Ω into 8 Ω
INPUT IMPEDANCE:	Odb (0.775 volts RMS)
TOTAL HARMONIC DISTORTION:	47K Ω
SIGNAL/NOISE RATIO:	Less than 0.1% at 25 watts typically 0.05 better than 75db
FREQUENCY RESPONSE:	10Hz-50KHz \pm 1db
SUPPLY VOLTAGE:	\pm 25 volts
SIZE:	105 x 50 x 25 mm

Price £5.40 mono, £10.80 stereo

Price inclusive of VAT & P & P

NEW HY5 PRE-AMPLIFIER

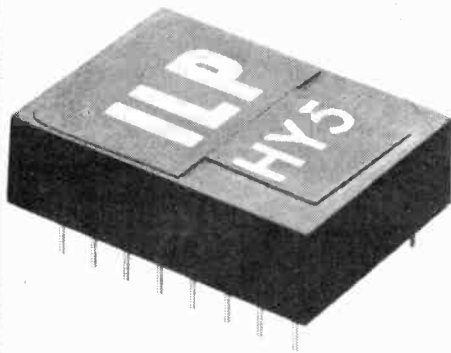

Unchallenged for two years, the HY5, our unique multifunction preamplifier/tone hybrid, has been brought into line with the advancements in our power hybrids. Like the HY50, the new HY5 has no external components & has been redesigned to run off a split power-line with improvements in signal/noise, overload, capability & reduced distortion. The output has been increased to match the power module (Odb), and to share the same power supply. Overall size is reduced by the use of a new thin film circuitry while the device still retains all the functions of the earlier device.

When combined with the HY50 & power supply only potentiometers are required to complete a simple mono amplifier with input & output facilities expected to be found on Hi-Fi amplifiers. The combination of two HY5's two HY50's sharing a common power supply (PSU50) are linked by a balance control to form a complete stereo system.

INPUTS	SPEC.
Magnetic Pick-up 3mV (within 1db RIAA curve)	
Ceramic Pick-up up to 3mV	
Microphone 10mV	
Tuner 250mV	
Auxiliary 3-100mV	
Input impedance 47k Ω 1k Ω	

OUTPUTS
Tape 100mV.
Main output, Odb (0.775volts)

ACTIVE TONE CONTROLS
Treble \pm 12db at 10kHz
Bass \pm 12db at 100Hz

OVERLOAD CAPABILITY (equalization stage) 40db on most sensitive input
OUTPUT NOISE LEVEL (below 10mV magnetic input) 68db

DISTORTION 0.05% at 1kHz
SUPPLY VOLTAGE \pm 15-25 volts
SUPPLY CURRENT 15mA

Price £4.51 mono, £9.02 stereo
Price inclusive of VAT & P & P

POWER SUPPLY PSU50

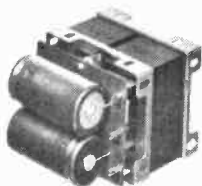

The new PSU50 has a low profile look being only 2 1/2 inches high and can be used for either mono or stereo systems.

SPEC.
OUTPUT VOLTAGE \pm 25 volts
INPUT VOLTAGE 210-240 volts
SIZE L. 70, D. 90, H. 60 mm

Price £5.23
Price inclusive of VAT & P & P

CROSSLAND HOUSE · NACKINGTON · CANTERBURY · KENT

CANTERBURY 63218

Please note we reserve the right to substitute at our discretion updated versions of advertised designs where applicable.

ELECTRONIC MULTIMETERS

Service type CT38 these are a 97 range unit covering AC and DC volts 250 Mill/V to 10Kv, AC and DC Amps 10 uA to 25 Amps, Resistance 0 to 1000 Megs, Watts 0 to 5 Watts at 15 to 5000 ohm load, R.F. probe unit for use to 200Mc/s, unit is for use on 200/250v 50c/s mains. Supplied tested with, accs., circ., copy of inst., etc. Good Cond. Price £21.

RADAR TEST UNIT TYPE 1

Used for testing S band Radar Rx, etc., contains 3" tube type VCR138 (okay for scope use) plus 19 other valves min. and octal types. Klystron CV2161 with tuning ass. etc., 4" dia. 50 Ua meter, complete in case size 17 x 11 x 16". These units have an internal P.U. but this is not suitable for use on 50c/s however most of the P.U. components Chokes, Conds., etc. can be used on 50c/s inc. EHT conds. Supplied complete in case, ex equipment with circuit, and circ. of Scope. Meter and Tube checked.

Price £10.45

V.H.F. TEST OSC.

Test Osc covering range 20 to 88 Mc/s in 4 bands also as 2 Mc/s Xtal check, R.F. can be Pulse Modulated at various freq. by selection of internal xtal. Also contains variable O/P Noise generator with 50 Ma monitor meter. Power required 250v HT at 60 Ma and 6.3v AC supplied with Cal charts and Ae, ex equipment.

Price £5.50

MISC. ITEMS

The following items are new, Trans. H.T. 230v Pria. Sec. 1125-0-1125v at 565 Ma £7.70. Matching Choke £1.50, also Sec. 415-143-0-143-415v at 360 Ma on 415v and 120 Ma on 143v £3.35. L.T. type 210/250v Pria. Sec. 27v at 41 amps. cont. rating £13.20. **HEAD** and **MIKE SETS** for 19 set m.c. type £1.80. **BLOWER MOTORS** for use on 6 to 24v DC double ended type size 6 x 4" £1.90. C.R.T. type 7BP7A 7" flat face tube, blue/yell. phosfor, 6.3 heater emag. focus and defl., with base conn., okay for slow scan T.V. etc. £1.83. **TRIMMERS** 20pf air spaced ceramic 10 for 55p. **NEONS** wire ended type req. 470K for 240v 10 for 55p. **PRESS. GAUGE** scale 0 to 120, vehicle type, elec. operated 44p.

X POINTER METERS dual 115Ua meter scale marked L & R, okay for Stereo Balance indicator (circuit supplied) £1.68.

HEADPHONE MATCHING TRANS. high to low impedance with 5ft lead with standard plug 60p. **BATTERIES** lead acid spillable aircraft type 24v 25 Amp/Hr. with inst. will split to make 2 x 12v £10.20, also 24v 4A/Hr. only £4.

THE FOLLOWING ITEMS ARE EX EQUIP. SWITCHES

YAXLEY TYPE with knob 4p 11w 4b 78p and 4p 4w 2b 40p both inc. low value res. **INVERTOR TRANS.** 12v DC to 300v at 150 Ma with circ. £2. **METER UNIT** 270 deg. FSD 1 Ma scale 0 to 20 size front 3 1/2" sq., glass 2 1/2" dia., also in same case centre reading meter 100-0-100 uA scale not marked and on/off flag type ind. Okay for rev. counter and center reading meter can be used as battery voltage ind. circuit for this supplied £3. **TOGGLE SWTS.** aircraft pattern suitable for L.V. DC use okay for car use, 2 for 33p. **TRANSISTORS** type OC42 pnp swt. type long leads marked 50 for 60p. **CONDS.** tuning split stator type 20pf per section 1 x 1/2 shaft 2 for 44p. **CODER UNIT** contains 10 mln. valves, 13 mln. relays 12v 2p c/o 12 mln. micro swts., all in case, size 10 x 7 x 5" plus misc. parts, good cond. £2.80. **VIDICON** camera tubes standard 1" type gen. purpose by E.E. and E.M.I. graded according to scan marks with data £9 and £6. **IND. 208** repeater ind. unit with CRT CV1528 2.75" dia., okay for scope use, with base and shield data supplied, note these have scan marks £1.77 B.N.C. sks. bulkhead type single nut fix. 75 ohm, 5 for 60p.

ABOVE PRICES INC. POST/CARR. AND VAT CHARGES, CARRIAGE CHARGES APPLY TO MAINLAND ONLY, SAE for LIST or ENQUIRY

A. H. SUPPLIES

57 MAIN ROAD, SHEFFIELD, S9 5HL
Tel. 444278 (0742)

Hold this while I solder it.



Sorry about that, Roger.

BAND-AID® Washproof Plasters.

© Johnson & Johnson LTD

* TRADE MARK

13 AMP DISTRIBUTION PANEL

From £2.85

Safe and quick. **FOUR** 13 amp 3-pin shuttered Socket Outlets Red neon warning indicator operates when in use. Only £8.85 + 38p p. & p. Also De Luxe Model (illus.) PLUS On/Off Switch. PLUS Magnetic Contact Breaker—If you draw too much current it switches off automatically. PLUS 30ft. (9 metres) approx. lead £8.85 + 45p p. & p. Six socket de-luxe £12.20 + 55p p. & p. Bonus offer: set of four fused 13 amp plugs 70p extra. Post free if ordered with a panel.

TWIN-BRAN SPEC-LAMP — Worn just like a pair of spectacles. Two powerful spot lamps illuminate working area. Can be worn with Binocular Magnifier. Battery operated. Only £8.85 + 10p p. & p. Send £2.45.

JOHN DUDLEY & CO. LTD. (Dept. WP4), 301 Cricklewood Lane, London, NW2. Tel.: 01-438 5917. Callers Welcome. Easy Parking.

BINOCULAR MAGNIFIER

FOR PERSONS CLOSE UP WORK LEAVES BOTH HANDS FREE



ONLY £6.65

See close-up work with less eye strain & fatigue. Lightweight adjustable headband. Powerful optically ground lenses from Continental glass-works. Can be worn over normal glasses. An essential aid in modelling, industry, home and workshop. Stamp collecting. Jewellers watchmakers and any fine work 2x magnification. £6.65 + 40p p. & p. 3 x model 65p extra. State model.

SPECIAL OFFER: Computer boards, ex-equipment with a good selection of semi-conductors, resistors, capacitors and other useful items. 5 for 75p including V.A.T.

An extensive range of Semi-conductors; Electrolytic capacitors; Mylar, Polyester and Ceramic capacitors; Fixed and Variable resistors. Brand new by well known manufacturers.

Send S.A.E. for comprehensive list to:—

W. P. COMPONENTS
7 Brook Avenue, Edgware,
Middlesex



SHORT WAVES

by **DAVID GIBSON, G3JDG**

IT'S an interesting period for Amateur Radio. The sunspot count continues to creep lower and the longer, darker (colder) nights are making 14/21MHz less favourite for DX working. For the s.w.l. who reckons he's up to tackling something a little more difficult, then I suggest a serious DX assault on 7MHz. This will assume more and more the role of the major DX band. Further down, on 3-5MHz, more DX is becoming apparent so it could well be an l.f. DX winter.

On 3-5MHz this past month, goodies like OA40S, ZS6TE and 9J2DT have been heard while up on 7MHz the air has been buzzing with c.w. offerings from calls like CM2JA, CR6AI, FG7XC, VK3MR, ZS5AN and 8P6DR.

Hair-raising happenings on top band. Several G stations have worked VP8KF in the Falklands. A few years back, this station would never have been thought about on 1-8MHz. Even now, a VP8 would cause excited s.w.l. squeaks if heard on 14MHz. Top-band sleuths are invited to lay in wait for r.f. travellers like ZL1MQ and a few JA stations who are known to be loitering. One station in Japan (JA7AO) has worked all continents (WAC) except Europe so it would be a safe bet to reckon his signal is there somewhere—who'll be first to report it?

Up on ten metres things seem to be fairly static. Long periods when one hears a noise like frying eggs (cheaper variety) and then, suddenly, an S9 plus five million dB's (well, it sounds like it) comes out of nowhere. South African stations are logged without too much effort and the South American continents comes romping in at times. Don't forget to listen first for the beacon stations since these will give a useful indication of what the bands are doing.

Before we take a peep at the logs sent in this month, let's open up the JDG little black book for contests in November. According to my crystal ball, the following are on: November 10-11, OK DX contest (c.w./phone); 10-11, topband contest; 11, four metre contest; 24-25, CQ WW (c.w./phone) contest.

First event in December is on the 9th and is a two metre contest for fixed stations—you've just got time to tie that 40-element Yagi beam to the chimney pot and switch on!

Readers' Logs

Dave Gregory (Plymouth) confesses, "I have been a Broadcast Bands maniac (is there any other kind?) for some months now". Brethren will be pleased to know that my Brother Gregory has seen the light and cleansed his sins by purchasing a 9R-59DS, RA-1 and CR100. With a homebrew a.t.u. and "DX processing unit" Dave repents on 14MHz with the following log; A51PN, A6XP, AR1RSP, EA7PS (an XYL—O'lay); WA5FW, ZB2BL, 3A2EE, 4Z4MQ, 5Z4GB, 5Z4GK.

A. McNeill (Newbury), comments on the many eastern europeans loose on 14MHz. He also praises the DX'ers processing unit which was featured in P.W. and queries the callign NI3A who keeps popping up. Are there NI takers to answer this?

Derek Harding (Godstone) says he's 23 years old and has been an s.w.l. for four days (What a waste of 22 years, 361 days). Derek asks how he can filter out the various loud whistles which beset him? Anyone got any thoughts other than the on/off switch?

John Turner sends in a 21MHz selection from a log made during his school holidays (think of all the conkers you missed). Gear in his bedroom at Doncaster includes a Pye Cambridge receiver with an 85ft end fed supplying the microvolts to the tune of; A2CCY, CE3OE, CN8CG, CP1HL, CR6AD, CT1BY, CX2CS, CX7BM, DU1FE, EA8CS, EA8HH/M, EL1G, ET3USA, HK3CDW, HS4AJL, JA4PE, JA6PIC, JA7KHZ, JH1DEV, KP4AD, KZ5EK, LU5MAO, M1C, PZ1DR, TI210, TR8VT, TU2DO, VK4PU, VP2MF, VP8ML, VP9CB, VQ9BP, YN1AZ, YV5EED, ZD3D, ZD8MH, ZS4JW, 4Z4LM, 7X0WW, 8R1J, 9G1AF, 9H1DP, 9M2DQ, 9U5CR, 9X5VA.

Tam Large (Hassocks) lives on a farm in Sussex. His favourite animal is a 9R-59DE. Feed it a staple diet of mains electricity and put it on a 200ft. end fed lead and it yields the following twenty metre tweets; CR6LX, HP1TG, K2LZQ/OH0, M1C, PZ1DR, 4W1AF. Similar treatment brought forth the following from 21MHz; TG9CQ, XE1GR, ZD3D, 9M2CX.

Paul Davies (Blackpool) is learning to read c.w. (good lad). Meanwhile, he listens with baited breath on 14MHz to the following juicy jingle; CR6GA, EL8J, EP2SP, ET3GA, HR2WTA, IB0PV, JA4JUV/MM, JY6HCT, KA6HQ, 9H1CQ, 9H4B, 9K2AL, 9M2DW, 9X5NA, all on s.s.b. Gear used is 5 Heath HR-10B, Joystick antenna and an a.t.u.

S. Eldridge (Crawley), has a CR70A, 132ft. end-fed looped round the bedroom and a yen to listen on 15 metres. Here's the gen on his yen; A6XB, CE3PY, CR6AG, CR6HZ, CT2AB, HI8LC, JA8ISK, JE1MUM, JF11UA, JH3EXI, JR1TAM, KA2PJ, LU6FEP, PT2JB, TI2STI, TR8VE, VQ9M, VU2DK, ZP5VO, ZS1J, ZS4JW, 5N2ESH, 5U7BA, 9X5VA.

BROADCAST BANDS

Short Wave Reports by 15th of the month to Malcolm Connah, 59 Windrush, Highworth, Windon, Wiltshire, SN6 7DT.

Medium Waves Logs to Charles Molloy, 132 Segars Lane, Southport, PR8 3JG.

VHF/FM Reports to Simon David, c/o Practical Wireless, Fleetway House, Farringdon Street, London, EC4A 4AD.

AMATEUR BANDS

Short Wave/VHF

Logs in alphabetical order please by 15th of the month to David Gibson, G3JDG, 12 Cross Way, Harpenden, Hertfordshire.

TRANSFORMERS

MAINS ISOLATING SERIES Primary 120/240 Volts Secondary 120/240 Volts Centre Tapped and Earth Shielded

Ref. No.	VA (Watts)	Weight lb oz	Size cm.	£	P & P
07	20	1 8	7.0 x 6.0 x 6.0	1.94	30
149	60	3 12	9.9 x 7.7 x 8.6	2.88	36
150	100	5 8	9.9 x 8.9 x 8.6	3.16	52
151	200	8 0	12.1 x 9.3 x 10.2	5.31	52
152	250	13 12	12.1 x 11.8 x 10.2	7.01	67
153	350	15 0	14.0 x 10.8 x 11.8	9.40	82
154	500	19 8	14.0 x 13.4 x 11.8	13.55	-
156	1000	38 0	17.2 x 16.6 x 14.0	24.97	-
158	2000	60 0	21.6 x 15.3 x 18.1	41.25	-

PLEASE NOTE
NEW ADDRESS
AS BELOW

AUTO SERIES

Ref. No.	VA (Watts)	Weight lb oz	Size cm.	Auto Taps	£	P & P
113	20	1 0	5.8 x 5.1 x 4.5	0-115-210-240	1.02	22
64	75	2 4	7.4 x 6.7 x 6.1	0-115-210-240	2.00	30
4	150	3 4	8.9 x 7.7 x 7.7	0-115-200-220-240	2.42	36
66	300	6 4	9.9 x 9.6 x 8.6	..	4.70	52
67	500	12 8	12.1 x 11.2 x 10.2	..	6.93	67
84	1000	19 8	14.0 x 13.4 x 14.3	..	12.69	82
93	1500	30 4	14.0 x 15.9 x 14.3	..	18.39	-
95	2000	32 0	17.2 x 16.6 x 14.0	..	24.00	-
73	3000	40 0	21.6 x 13.4 x 18.1	..	32.67	-

TOTALLY ENCLOSED 115V AUTO TRANSFORMERS
115V 500 Watt totally enclosed auto transformer, complete with mains lead and two 115V outlet sockets. £9.49, P & P 67p.
Also available a 20 Watt version 12.02 P & P 27p

LOW VOLTAGE SERIES (ISOLATED)

Ref. No.	12V 24V	Amps.	Weight lb oz	Size cm.	Secondary Windings	£	P & P
111	0.5	0.25	1 8	4.8 x 2.9 x 3.5	0-12V at 0-25A-2	1.02	22
213	1.0	0.5	1 4	6.1 x 5.8 x 4.8	0-12V at 0-5A-2	1.22	22
71	2	1	1 12	7.0 x 6.4 x 6.1	0-12V at 1A-2	1.50	22
18	4	2	1 8	8.2 x 7.7 x 7.0	0-12V at 2A-2	2.24	30
70	6	3	3 8	8.9 x 8.0 x 7.7	0-12V at 3A-2	2.70	42
108	8	4	5 8	9.9 x 8.9 x 8.6	0-12V at 4A-2	3.00	52
72	10	5	6 4	9.9 x 9.6 x 8.6	0-12V at 5A-2	3.55	52
17	16	0	8 12	12.1 x 9.9 x 10.2	0-12V at 8A-2	5.48	52
115	20	10	11 8	14.0 x 9.6 x 11.8	0-12V at 10A-2	6.98	67
187	30	15	15 8	17.2 x 11.8 x 11.8	0-12V at 15A-2	12.90	82
226	60	30	32 0	17.2 x 15.3 x 14.0	0-12V at 30A-2	23.72	*

30 VOLT RANGE

Ref. No.	Amps.	Weight lb oz	Size cm.	Secondary Taps	£	P & P
112	0.5	1 4	6.1 x 5.8 x 4.8	0-12-15-20-24-30V	1.22	22
79	1.0	2 4	7.0 x 6.7 x 6.1	..	1.62	36
3	2.0	3 4	8.9 x 7.7 x 7.7	..	2.43	36
20	3.0	4 8	9.9 x 8.3 x 8.6	..	2.99	42
21	4.0	6 4	9.9 x 9.6 x 8.6	..	3.55	52
51	5.0	6 12	12.1 x 8.6 x 10.2	..	4.42	52
117	6.0	8 0	12.1 x 9.3 x 10.2	..	5.28	52
88	8.0	12 0	12.1 x 11.8 x 10.2	..	6.82	67
89	19.0	13 12	14.0 x 10.2 x 11.8	..	8.36	67

50 VOLT RANGE

Ref. No.	Amps.	Weight lb oz	Size cm.	Secondary Taps	£	P & P
102	0.5	1 12	7.0 x 6.4 x 6.0	0-19-25-33-40-50V	1.60	30
103	1.0	2 12	8.3 x 7.4 x 7.1	..	2.34	36
104	2.0	5 8	9.9 x 8.9 x 8.6	..	3.25	42
105	3.0	6 12	9.9 x 10.2 x 8.6	..	4.41	52
106	4.0	10 0	12.1 x 10.5 x 10.2	..	5.48	52
107	6.0	12 0	14.0 x 10.2 x 11.8	..	6.83	67
118	8.0	18 0	14.0 x 12.7 x 11.8	..	11.27	97
119	10.0	25 0	17.2 x 12.7 x 14.0	..	14.13	*

60 VOLT RANGE

Ref. No.	Amps.	Weight lb oz	Size cm.	Secondary Taps	£	P & P
124	0.5	2 4	7.0 x 6.7 x 6.1	0-24-30-40-42B-69C	1.62	36
126	1.0	3 4	8.9 x 7.7 x 7.7	..	2.26	36
127	2.0	6 4	9.9 x 9.6 x 8.6	..	3.55	42
125	3.0	8 12	12.1 x 9.9 x 10.2	..	5.41	52
123	4.0	13 12	12.1 x 11.8 x 10.2	..	6.98	67
120	6.0	15 8	14.0 x 12.1 x 11.8	..	10.12	82
122	10.0	25 0	17.2 x 12.7 x 14.0	..	16.75	*

LEAD ACID BATTERY CHARGED TYPES

Ref. No.	Amps.	Weight lb oz	Size cm.	£	P & P
43	1.5	1 8	7.0 x 6.1 x 6.1	1.61	30
5	4.0	3 4	8.9 x 7.7 x 7.7	2.45	42
83	6.0	6 4	9.9 x 9.6 x 8.6	3.70	52
146	8.0	6 12	9.9 x 10.2 x 8.6	4.22	52
58	12.5	12 0	14.0 x 10.2 x 11.8	6.29	67

All ratings are continuous. Standard construction; open with solder tags and vacuum impregnation. * Carriage via B.R.S.

FULL SPEC. TRANSISTORS

BC107/108/109 12p each | 2N 3055 60p each | AD161 162 60p pair
+ mica and bushes | + mica and bushes

ELECTROSIL RESISTORS · AVOMETERS

PLEASE ADD 10% FOR V.A.T.
INCLUDING P. & P.

BARRIE electronics

3, THE MINORIES, LONDON EC3N 1BJ

TELEPHONE: 01-488 3316/8

NEAREST TUBE STATIONS: ALDGATE & LIVERPOOL ST

MEN! GIRLS!

YOU CAN EARN £50 p.w.
Plus an exciting life and a secure future.
HOW?

Get into the fabulous Computer Industry now. On the ground floor. While industry, commerce, science and governments are desperately seeking trained personnel. Give us only four to six weeks and we can train you in any one of the three vital careers in computers: (1) Programming (men and girls). (2) Operating (men and girls). (3) Key Punching (girls exclusively).

We are the only training organisation able to make this offer. And our teaching methods succeed because they combine specially prepared courses with equipment such as the unique Eductor, exclusive to us.

Thanks to our methods, people from all walks of life have exchanged boring, underpaid, insecure jobs for careers that have meaning, prestige and security.

Past performance counts for nothing. Provided you have the aptitude (which we can discover quite simply), there is no reason why you should not get out of the rut and into Tomorrow's World—the fascinating world of Computers.

The moment you qualify—and we will help you do just that—one of our own exclusive appointments agencies will introduce you to opportunities galore. Worldwide. At no cost to you. All part of our continuing service.

What have you to lose by enquiring? Information and advice are yours for the asking. Post the coupon TODAY for full details FREE and without obligation.

London Computer Training Services

R67, Oxford House, 9-15 Oxford Street, W.1. Telephone: 01-437 9906

Please send me your free illustrated brochure on training for
Computer Programming
(men and girls)

Computer Operating
(men and girls)

Key Punching
(girls exclusively)

(tick appropriate box)

Name

Address

Tel.



INTERNET

**ALL OFFERS APPLY TO UK ONLY
WHILST STOCKS LAST**

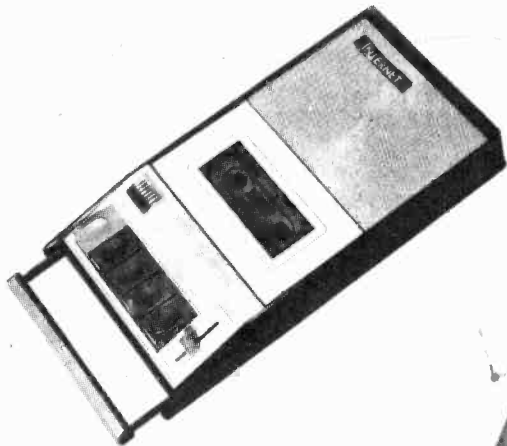

Cassette Tape Recorder AC 240V.
Works on 6V battery 4 x 1/2 U11. Piano
keys. Sliding. V/C Earphone. Rem. Mic.
Built-in Condenser Type Microphone.

£9.18 + 92 VAT. Price £10.10, P. & P.
included.

Microphone opt. £2.00 + VAT.

Cassette Tape opt. 35p + VAT.

Car Radio No. S101. 12V. Neg. and Pos.
polarity, Fixing Bracket. 4" Speaker.

£6.20 + 62p VAT. Price £6.82.

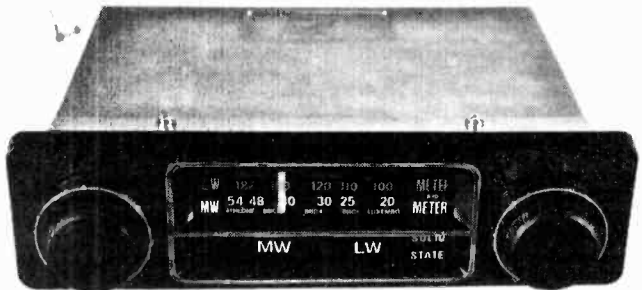

Radio MW/LW No. J70. MW/LW. Battery
only, LX12 U12. Pen Light.

£4.20 + 42p VAT. Price £4.62, P. and P.
included.

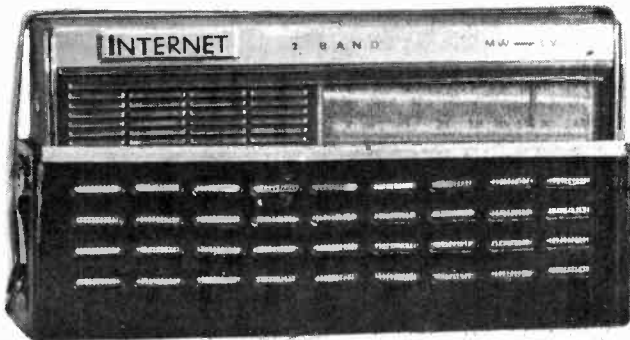

INTERNET RADIO (PRODUCTS) LTD.

100-102 BECKENHAM ROAD, BECKENHAM, KENT, BR3 4RH

NAME

ADDRESS

VAT INVOICES ON REQUEST

UNLESS SHOWN OTHERWISE P & P ON U.K.
 ORDERS IS 8p. OVERSEAS ORDERS AT COST

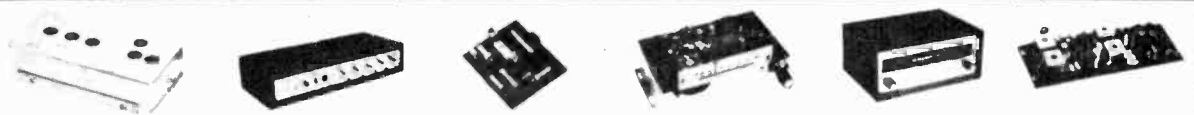

Mullard LP1186
 Varactor diode tuned F.M. tuning heart £4-15, as described in P.E. May 1973. LP1185 matching I.F. strip. £4-85.

THE TEXAN
 20 - 20 Watt Integrated Stereo Amplifier Kit. Superb state-of-the-art design by engineers of Texas Instruments. £31-35 + P & P 49p.

SGS EA1000
 3 watt amplifier module. Price including handbook and FREE heatsink. Our price £2-49. Quantity discounts.

A1005S
 F.M. tuner chassis. fully transistorised. 9 Volt positive earth operation. Our Price £6 35.

A1018
 F.M. tuner, similar to A1005S but in oiled walnut cabinet, etc. Our Price £9-38.

A1005MS
 Multiplex Stereo Decoder, fully built and aligned, to match A1005S. Our Price £5-95.

AUDIO I.C.'S
 Audio I.C. Leaflet No. 12 FREE (only with I.C. s—10p separately.)

Pre-Amplifiers
 Dual. MC1303L £1-89
 Low Noise Dual. MC1339P £1-29

Amplifiers
 250mW. MFC4000A 49p
 1 watt. TAA300 £1-79
 2 watt. LM380 £1-59
 5 watt. TBA800 £1-59
 15 watt. BHA0002 £3-95
 35 watt driver. NE540L £1-32

3 1/2 decade DVM

• Maximum Display — or — 1.999V
 • Minimum Display — or — 1mV
 • Can be scaled up to read 1.999V
 • Automatic Polarity Detection
 • Dual Ramp Integration
 • Automatic Overrange Indication
 • Up to 50 readings per second
 • Chopper Output provided

Supplied with complete data
 All this on a single 16 pin DIL packed MOS LSI Integrated Circuit

A State-of-the-Art Digital Voltmeter I.C. for only £7-79

Linears

	8pin Dip	70ss	14pin Di
709	34p	40p	35p
710	35p	40p	35p
711		45p	39p
723		56p	55p
724	42p	45p	43p
727		92p	92p
748	42p	55p	43p

CA3046 £1-65
 CA3075 £1-85
 CA3082 £1-65
 LM1010 £1-99
 LM201H £1-15
 LM301 £1-05
 LM307N £8p
 LM308N £1-45
 LM309K £2-69
 MC1330 £8p
 MC1350 83p
 MC1351 £1-59
 MC1352 £1-10
 MC1357 £1-59
 MC1358 £1-75
 MC1456G £1-75
 MC1458CP £2-42
 MC1455 £5-65
 MC1489N £1-49
 MC3401 77p
 MFC4010A 81p
 MFC4060 79p
 MFC6030A 83p
 MFC6040 £1-10

MVRSVL8005 £1-65
 MVRSVL9005 £1-65
 MVRSVL9037 £1-65
 NE5555 £9p
 NE560B £4-92
 NE561B £4-92
 NE562 £4-92
 NE563 £3-49
 NE565 £2-75
 NE567 £3-49
 SG3402N £2-08
 SL440 £2-29
 TAA263 £9p
 TAA293 £9p
 TAA310 £1-37
 TAA320 £9p
 TAA370 £2-54
 TAA550 £1-15
 TAD150 £1-65
 TAD110 £1-65
 TBA550 £1-65
 TBA550 £1-65
 ULN2111A £1-59

Coil-less Phase-Locked Loop I.C. Stereo Decoder

Motorola MC1310, supplied completely with our leaflet No. 11
 Our Price £3.05

MC1312 decodes CBS. SQ. Free leaflet No. 11 gives full circuit and details.
 Our Price £6-49

QUADRISONICS
 inc. all parts for decoder, inc. Veroboard, V.A.T., P & P. (Leaflet alone 10p.)

The component people

Dept. 1
 56, Fortis Green Road, London, N10 3HN
 telephone: 883 3705

INDUCTORS

MULLARD block filter LP1175 as used with TAD100 now only £1-49

R.F. CHOKES, 0-1µH to 19mH. For full details ask for List No. 5. P & P 5p.

DENCO BLOCKS

Transistor Range:
 Series 1T to 5T inclusive Blue, Yellow, Red and White all 44p each.
 I.F. Transformers: IFT13, 14, 16 and 17, 55p each; IFT 15, 76p; IFT18, 73p.

Dual Purpose Range: Series 1 to 7 inc. Blue, Yellow, Red and White, 44p each.
 1 to 5 Green List No. 5 gives full details.
 Ferrite Aerials: Medium and Long—state 300pF or 500pF tuning 87p each

Tuning Gangs

Type C804	Type 0
50pF 61p	365pF 80p
50pF 66p	365 - 365pF 96p
10pF 61p	Type 00
15pF 61p	208 - 176pF with screen and trimmers 99p
20pF 66p	
100pF 75p	
25pF 61p	

P & P all types 10p

NEW FERRANTI RANGE

The Radio I.C. in a TO18 can. Supplied with our data leaflet No. 10. Giving circuits and component information. (Leaflet alone 10p.)

	Our Price £1.32	
ZN414		
BFS59 15p	ZTX302 17p	ZTX450 17p
BFS60 20p	ZTX303 14p	ZTX451 17p
BFS61 20p	ZTX304 21p	ZTX500 12p
BFS96 15p	ZTX310 9p	ZTX501 13p
BFS97 23p	ZTX311 10p	ZTX502 17p
BFS98 20p	ZTX312 10p	ZTX503 14p
	ZTX313 11p	ZTX504 43p
ZTX107 8p	ZTX314 13p	ZTX510 17p
ZTX108 8p	ZTX320 31p	ZTX530 22p
ZTX109 11p	ZTX330 15p	ZTX531 22p
ZTX212 14p	ZTX331 16p	ZTX550 17p
ZTX213 14p	ZTX341 22p	ZTX551 17p
ZTX214 15p	ZTX382 13p	
ZTX300 12p	ZTX383 15p	DIODES
ZTX301 13p	ZTX384 18p	ZS120 8p
		ZS270 11p
		ZS271 16p

KSO30A
 Zener Series as BZY88 Series 11p each.

ELECTROLYTICS

µF	4V	6.2V	10V	16V	25V	40V	63V	100V
1							6p	8p
1.5							6p	8p
2							6p	8p
2.2							6p	8p
3							6p	8p
3.3							6p	8p
4.7							6p	8p
5							6p	8p
6.8							6p	8p
10							6p	8p
15							6p	8p
22							6p	8p
27							6p	8p
68	6p	6p	6p	6p	6p	6p	8p	10p
100	6p	6p	6p	6p	6p	8p	11p	23p
150	6p	6p	6p	6p	6p	10p	13p	19p
220	6p	6p	6p	8p	10p	11p	19p	31p
330	6p	6p	8p	10p	13p	19p	22p	39p
470	6p	10p	10p	13p	20p	23p	26p	48p
680		10p	10p	13p	20p	23p	26p	48p
1000	10p	12p	11p	17p	22p	25p	44p	79p
1500		12p	20p	23p				
2200		18p	20p		36p	44p	79p	148p
3300		20p			44p	79p	148p	252p
4700	29p			44p	68p	79p	148p	252p
6400				75p	93p			
10000							299p	333p

Potentiometers

5kΩ 250kΩ
 10kΩ 500kΩ
 25kΩ 1MΩ
 50kΩ 2MΩ
 100kΩ

Log or lin less switch (and 1kΩ lin) 13p
 Log or lin with switch 26p
 Dual less switch 44p
 Dual with switch 10kΩ, 100kΩ and 1MΩ log only 57p
 10kΩ log - 10kΩ anti-log less switch 44p

10kΩ 10p
 25kΩ 3p
 50kΩ Single
 100kΩ Dual
 100kΩ 55p

New Silver and Black Knob 16p

Presets

Vertical or Horizontal

0.1 watt 5p 0.25 watt 7p
 100Ω 1kΩ 5p 100kΩ 100kΩ 1MΩ
 250Ω 2.5kΩ 25kΩ 250kΩ 2.5MΩ
 500Ω 5kΩ 50kΩ 500kΩ 5MΩ

Chromalox Type to 1MΩ only 41p.

VDR's & Thermistors

A15B	82p	GL23	£1 10
CZ1	16p	R53	£1 49
CZ4	14p	R54	£1 61
CZ13A	14p	VA1005	16p
CZ19	14p	VA1028	14p
E298CD A258	13p	VA1033	11p
E298ED A259	11p	VA1034	11p
E298ED A260	11p	VA1038	16p
E298ED A262	11p	VA1040	11p
E298ED A265	11p	VA1053	11p
E298ED P268	11p	VA1055S	11p
E298Z2 05	13p	VA1056S	11p
E298Z2 06	11p	VA1066S	11p
E299DD P338	11p	VA1083S	16p
E299DD P338	11p	VA1077	14p
E299DD P342	11p	VA1098	21p
E299DD P348	11p	VA1104	29p
GL16	£1 10	VA1107	25p

Other types obtainable upon application

SOUTHEND ELECTRONICS

COLOUR 25 KV TRIPLERS



£1.70 + 17p V.A.T.

REPLACEMENT TRIPLERS

PYE C72 SERIES
GEC 2028 SERIES
PHILIPS G8 SERIES
£3.00 + 30p V.A.T.

E.H.T. RECTIFIER STICKS

X80/150D
10p 1p V.A.T.

TRANSISTOR TUNER UNITS

VHF/UHF	£2.00	20p V.A.T.
6 Push Button VHF/UHF	£2.50	25p V.A.T.
6 Push Button UHF	£3.00	30p V.A.T.
UHF	£1.50	15p V.A.T.
300 Mixed Condenser	£1.00	10p V.A.T.
350 Mixed Resistor	£1.00	10p V.A.T.
100 w/w Resistor	£1.00	10p V.A.T.
40 Mixed Pots	£1.00	10p V.A.T.

PRINT PANELS WITH TRANSISTOR
& RESISTOR & CONDENSER & RELAYS
£1.00 10p V.A.T.

Money returned if not completely satisfied

COLOUR PANELS
TRANSISTORS RESISTOR CONDENSER
ETC.
£1.00 10p V.A.T.

I.F. PANELS with Transistor & Resistors
10p 1p V.A.T.

SOUTHEND ELECTRONICS

240 RAYLEIGH RD., EASTWOOD,
LEIGH-ON-SEA, ESSEX
Telephone: Southend 521363
P.P. PAID UK ONLY

Reg: Office Only—No Personal Callers Please

NEW
ALL
SILICON!



PRACTICAL
WIRELESS

ELECTRONIC IGNITION SYSTEM

This Capacitor-Discharge Electronic Ignition System was recently described in Practical Wireless and has proved extremely popular. We are able to offer the kit in two forms; the standard kit containing the electronic components only, enabling the customer to tailor these to his own layout, or the de-luxe version containing a ready-drilled roller-tinned printed-circuit board and fully machined die-cast case with A.M.P Electrical Spade Connector Block. Each kit is supplied with a custom wound transformer, first grade components and full constructional details.

The original circuit employed Germanium Power Transistors for the negative earth version. **WE NOW SUPPLY SILICON P.N.P. POWER DEVICES AT NO EXTRA COST!** All components available separately. Case size 4 1/2" x 3 1/2" x 2". Complete assembly and wiring manual 25p, supplied with de-luxe kit only, refundable on purchase of kit.

Suitable for 12v systems with Pos. or Neg. earth.
Price: Standard Kit£7.97 U.K. Post Free
De-Luxe Kit£9.02 U.K. Post Free

Quantity Discounts:
Trade and Overseas 1-5 Nett 6-9 Less 10%
Enquiries Invited 10-49 Less 15% 50-99 Less 20%
Mail Order Only 100-999 Less 25% 1000 up Less 30%

ALL PRICES INCLUDE VAT

PLEASE STATE POS. OR NEG. EARTH WHEN ORDERING.

DABAR ELECTRONIC PRODUCTS

98A LICHFIELD STREET,
WALSALL, STAFFS. WS1 1UZ
Tel. Walsall 34365

ELECTROLYTIC CAPACITORS UF/V 2000/50, 2500/50, 5000/50, 10,000/50, 12,500/50. All at 50p each, post paid.

SPECIAL OFFER: WIRE-ENDED METALLISED FILM CAPACITORS
2.2UF 63V 15p. 4UF 63V 20p. 6UF 63V 20p. 8UF 63V 25p. 10UF 63V 25p.
All post paid.

SOKSOL DE-SOLDER KIT: Includes 20ft special copper braid, chemical solution and instructions £1, post 15p.

DELCO-REMY 12 Volt Car-Horn Relays 50p, post paid.

SUBMINIATURE PLUG-IN CRYSTALS for radio control. 26.985MHz and 27.025MHz 70p each, post paid.

AMERICAN DYNAMOTOR ROTARY TRANSFORMERS.
Input 27 Volts D.C. Output 285 Volts D.C. at 75 M/A £1.00, post 30p.

PLESSEY VIBRATORS Type 1214 50p, post paid.

ADD 10% V.A.T.

SEE OUR OTHER ADVERTISEMENTS IN
RADIO & ELECTRONICS CONSTRUCTOR

ELEKON ENTERPRISES

224a St Paul's Road, Highbury Corner, London N.1
Telephone 01-359 4224

LEARN RADIO & ELECTRONICS AT HOME

No knowledge needed—
build as you learn with
the exciting new
'Technatron' kit. No
Extras. Tools, transistors,
meter etc. All supplied.
You could build a
radio in weeks.

SEND FOR FREE 76 PAGE GUIDE TO RADIO/TV,
ELECTRONICS, C & G, TELECOMMS ETC.

Dept. BPW22 Aldermaston Court, Reading RG7 4PF

Name.....

Address.....

Age..... CV BPW22

BRITISH INSTITUTE OF ENGINEERING TECHNOLOGY



SPECIAL INTRODUCTORY OFFERS—IMPORTER TO CONSUMER!

ALL NEW GOODS—FULLY GUARANTEED—PLEASE ADD 10% V.A.T. TO TOTAL ORDER INCLUDING P. & P.

HILLS HEADPHONE JUNCTION BOX MODEL JB-3
Designed to connect headphone to amplifier previously not fitted with headphone socket, or alternatively for remote switching 3 position switch allows instant switching between speakers and headphones or both simultaneously.
Rec. Retail OUR PRICE **£1.25** P. & P. 15p



HILLS DYNAMIC HEADPHONE MODEL H-707 VS DE-LUXE
An extremely high quality headphone supplied with Padded Headphone and Ear-cups together with SLIDER volume controls for precise listening levels. Specially offered at an unbeatable price. 8 ohms 20-20,000Hz.
Retail Price OUR PRICE **£5.75** P. & P. 25p



CAR STEREO SPEAKERS MODEL CRB-200
These dual purpose Car Speakers can be used for either shelf mounting or converted to door mounting. Six 5 watt Speakers ensure a brilliant audio performance.
Rec. Retail OUR PRICE **£3.50** P. & P. 25p



ANTEX SOLDERING IRONS		P/P 12p
	REC. RETAIL	OUR PRICE
CCN240 15 watt	2.15	£1.60
X25 25 watt	1.93	£1.40
Ferranti Radio Chip ZN414. OUR PRICE £1 10. P. & P. 5p.		
Hills Coiled Headphone Extension Cable, 15ft. Rec. Retail £2.25. OUR PRICE £1 45. P. & P. 10p.		

"HOMER" INTERCOM
One of the leading makes. Ideal for home, office, factories, etc. This 2-station intercom has hidden volume control and on-off switch. Supplied with 6ft. cable and batteries.
Rec. Retail OUR PRICE **£2.75** P. & P. 15p



HILLS DYNAMIC HEADPHONE MODEL H-101 VSM
Offered at a remarkably low price, supplied with padded Headband and Earcups. Adjustable volume control with stereo and mono switch. 8 ohms imp. 10 18,000Hz.
Rec. Retail OUR PRICE **£3.75** P. & P. 25p



PLINTH AND COVER FOR GARRARD SP-25 III BSR MP-60. OUR PRICE £2.75. plus 65p P. & P.
ELAC SPEAKER, 8in 8 ohm CERAMIC AND TWEETER, £2 70, plus 20p P. & P.
OTHER ITEMS AT BARGAIN PRICES OFFERED IN OUR AUDIO COMPONENTS CATALOGUE. PLEASE WRITE FOR A FREE COPY (ENCLOSING 3d STAMP)

HILLS COMPONENTS LTD.
DEPT. (PW-12), UNIT No. 6, MELINITE INDUSTRIAL ESTATE, BRITTON ROAD, WATFORD, HERTS. WQ2 5SL. Tel. Watford 27711

FAN/BLOWER
Precision-built in Germany. Dynamically balanced mains unit (200/240) continuous rated, reversible 60MA on run. Size: 6 1/2" dia. x 2 1/2" deep. Back plate is tapped for 4 fixing screws (supplied). Well under maker's price at £3. P. & P. 20p. Similar unit to above but 7 1/2" dia. x 3" deep. £4.50 P. & P. 25p.

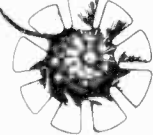

"DAVENSET" MAINS SOLENOID
1" travel. 8lbs. pull (approx.). Size: 2 1/2" long x 2 3/16" x 2" high. Similar in appearance to "SORENG". £1.50. P. & P. 20p.

MAINS SOLENOID

This little unit gives vertical lift of approximately 1" through hinged "elbow". Bracket incorporates 2 fixing screws. Length of arm. 2 1/2". 240V AC. Pull at coil is approximately 1lb. £1. FREE P. & P. Special quotes for quantities.



SMITHS RINGER-TIMER
Reliable 15 minute times, spring wound (concurrent with time setting) 15 x 1 min divisions, approximately 1/2" between divisions. Panel mounting with chrome bezel 3 1/2" dia. £1.30. 15p P. & P.



Solenoids by Westool
240 AC type MM6. 3lb. pull. 2 1/2" x 1" x 1 1/2". Travel 1". 85p each. P. & P. 10p.



GEARED MOTORS
"Parvalux" Reversible 100 rpm geared motor. Type SD14, 230/250v. AC. 22 1/2" spindle. 1st class condition. £7.50 each. 50p P. & P. Also limited number only as above. BRAND NEW. £12.50 each. P. & P.



240AC type MM4. 2lb. pull. 1 1/2" x 1 1/2" x 1". Travel 1/2". 60p each. P. & P. 10p. Quantity discounts: 10-50 10%. 50 upwards 25%.



REVERSIBLE Parvalux type SD19. 240V. AC. 30rpm. 40 lbs/in. Variable angle drive shaft. ABSOLUTELY AS NEW. £6.30. P. & P. 50p.

"DECCO" MAINS SOLENOID
Compact and very powerful. 16lb. pull. 1/2" travel which can be increased to 1" by removing captive-end-plate. Overall size: 2" x 2 1/2" x 2 1/2" high. £2. P. & P. 20p.



SHADED POLE Mains motor. 1 1/2" x 1 1/2" x 2" high. Double ended 7/8" shaft projecting 1/2" each side of motor. £1. P. & P. 20p.

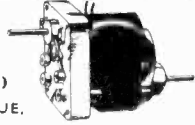

MAINS SOLENOID by MAGNETIC DEVICES LTD.
A (beautifully constructed solenoid at half normal price. A 2-sided bracket is incorporated for vertical or horizontal mounting. Size: 2" x 1 1/2" x 1 1/2". Pull is approximately 2lbs., plunger travel 1 1/2". Fixing eye takes up to 1/2" bolt, plunger non-captive. NEW in original maker's boxes. £1 P. & P. 20p. Large number available, special price for quantity.



OPEN FRAME shaded pole GEARED MOTORS
(Dural gear case) 240 AC. 28rpm. NEW HIGH TORQUE. approx. overall size: 3 1/2" x 3 1/2" x 2 1/2" + spindle 1/2" dia. as illustrated. £2.70. P. & P. 30p. Similar to above. 19rpm. £2.70. P. & P. 30p. 110rpm with pressed steel gear case (similar to above but slightly smaller). £2.70. P. & P. 30p.



"CROUZET" MOTORS 3 RPM Type 965
115/240v. 50Hz. 48w. Stoutly constructed, 2 11/16" dia. x 3 1/2" long plus spindle 1" x 1/2" dia. Anti-clock. £3 each P. & P. 25p.



SPIT MOTOR
5 1/2rpm. 2 1/2" x 1 1/2" x 6 1/2" high. 240v. AC. Shaft 3/8" o/d. 1 1/2" length with hexagon socket inside. £1.80. P. & P. 30p.



"RE CIRK IT" Mains 10amp cut-out
by "Neiman Electric" Germany. Eliminates fuses. Size: 2" x 2 1/2" x 1 1/2" deep. 90p each. P. & P. 10p. 10 or more 70p each. P. & P. 20p.



AMPEX 7.5v. DC MOTOR
This is an ultra precision tape motor designed for use in the AMPEX model AG20 portable recorder. Torque 450GM/CM. Stall load at 500ma. Draws 60ma on run. 600rpm ± speed adjustment. Internal AF/RF suppression. 1/2" dia. x 1" spindle, motor 3/8" dia. x 1 1/2". Original cost £16.50. OUR PRICE £3. P. & P. 25p. Large quantities available (special quotations). Mu-metal enclosure available. 75p each. FREE P. & P.

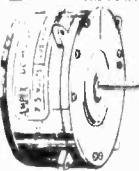

UNLESS OTHERWISE STATED
all items are NEW and UNUSED. Postal or carriage charges are for Gt. Britain only. We welcome orders from established companies, educational depts., etc. All orders under £2.50. C.W.O., please. Company orders under £2.50. Surcharge 60p unless C.W.O.

KNOWLE (U.S.A.) MINIATURE MICROPHONE CAPSULES
Impedance approx. 200Ω, output 60 or 80 DB at 1 Kc. As used in deaf aids, bugging devices, etc. Size (60 DB) 7/32" x 5/32" x 1/2"; (80 DB) 1/2" x 5/32" x 1/2". Ex. equipment, all tested. £1.20 each. P. & P. FREE.

PLUG-IN RELAYS by SCHRACK (PERSPEX ENCLOSED)
OCTAL (2 c/o) 6 amp contacts at following voltages: 48 D.C., 60 D.C., 60 A.C., 110 D.C., 380 A.C. PRICE EACH 90p

11 pin (3 c/o) 6 amp contacts: 12 A.C., 48 D.C., 48 A.C., 60 A.C., 60 D.C., 110 D.C., 115 A.C., 240 A.C. PRICE EACH £1

RA and RN Series (4 c/o) 3 amp Gold Plated Contacts. Handsome modern construction 1 1/2" x 1 1/2" x 1 1/2" high. Following voltages: 6 A.C., 12 A.C., 24 A.C., 48 A.C., 48 D.C., 60 A.C., 110 D.C., 115 A.C., 120 A.C. PRICE EACH 80p

Base sockets for all above types 10p. Please add 10p towards P & P on all orders.

From JAPAN, TAKAMISAWA Perspex enclosed relays. Type MQ 308. 24V. DC. 600 ohms (4 c/o). Complete with base socket. 80p P. & P. 10p.

SILVANIA MAGNETIC SWITCH
Now complete with reference magnet!
A magnetically activated switch, vacuum sealed in a glass envelope. Silver contacts, normally closed. Rated 3amp at 120v. 1/2" amp at 240v. Size: (approx.) 1 1/2" long x 1/2" dia. Ideal for burglar alarms, security systems, etc., and wherever non-mechanical switching is required. 10 for £1.80; P. & P. 15p. 50 for £9; 100 for £15. FREE P & P over 10.



NORPLEX
The famous American fibre-glass copper-clad laminate. Finest quality with woven glass base of Epoxy-resin. Excellent Mech. and Elec. conductive properties. Heat resistant. Ideal for P.C.'s, etc. THIS IS A SPECIAL PURCHASE AND ONLY AVAILABLE WHILE STOCKS LAST! Sizes: 12" x 12"; 24" x 12"; 24" x 24"; FULL SHEET 43" x 37" (11 sq. ft.). Single-sided Copper with thickness of 1/32", 3/64", 3/32". Also double-sided 1/32", 1/16", 3/32". £1 per sq. ft. Cut sizes (1-10 sq. ft.) 25p P. & P. Full Sheet £8 each. Carr. £1 for 1st sheet plus 25p each additional sheet.

TANGENTIAL HEATER
Silently driven by shaded pole Mylex motor, powerful and smooth running with aluminium impeller (outlet 5/8" x 1 1/2"). Mains voltage PLUS matching heater unit with spiral element. May be switched for 500 or 1,000w. £1.60. P. & P. 30p.

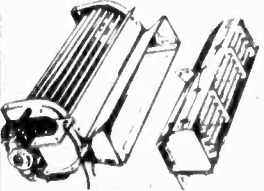

PLEASE ADD 10% FOR V.A.T. ON ALL PRICES SHOWN INCLUDING P & P

315/317, EDGWARE ROAD, LONDON, W2. Tel: 01-723 5667 01-402 5580

ELECTRO-TECH COMPONENTS LTD.

BI-PRE-PAK

SUPPLIERS OF SEMI-CONDUCTORS TO THE WORLD

COMPLETE TELEPHONES



EX. G.P.O. NORMAL HOUSEHOLD TYPE
ONLY £1.05
 POST & PACKING 45p EACH
TELEPHONE DIALS
 Standard Post Office type. Guaranteed in working order.
ONLY 27½p
 POST & PACKING 161p

TESTED AND GUARANTEED PAKS

B79	4	IN4007 Sil. Rec. diodes, 1,000 PIV lamp plastic	55p
B81	10	Reed Switches, 1" long, ½" dia. High Speed P.O. type	55p
B99	200	Mixed Capacitors. Approx. quantity, counted by weight	55p P & P 15p
H4	250	Mixed Resistors. Approx. quantity counted by weight	55p P & P 15p
H7	40	Wirewound Resistors. Mixed types and values.	55p
H9	2	OC71 Light Sensitive Photo Transistor	55p
H28	20	OC2001/2/3 PNP Silicon uncodded TO-5 can	55p
H30	20	1 Watt Zener Diodes, Mixed Voltages 6.8 - 43V.	55p
H35	100	Mixed Diodes, Germ. Gold bonded, etc. Marked and Unmarked.	55p
H38	30	Short lead Transistors, NPN Silicon Planar types.	55p
H39	6	Integrated Circuits, 4 Gates BMC 962, 2 Flip Flops BMC 945	55p
H40	20	BFY50/2, 2N696, 2N1613 NPN Silicon uncodded TO-5	55p
H41	2	Sil Power transistor's comp pair BD131/132	55p

UNMARKED UNTESTED PACKS

B1	50	Germanium Transistors PNP, AF and RF	55p
B66	150	Germanium Diodes Min. glass type	55p
B83	200	Trans. manufacturers' rejects all types NPN, PNP, Sil. and Germ.	55p
B84	100	Silicon Diodes DO-7 glass equiv. to OA200, OA202	55p
B86	100	Sil. Diodes sub. min. IN914 and IN916 types	55p
H6	40	250mW. Zener Diodes DO-7 Min. Glass Type	55p
H15	30	Top Hat Silicon Rectifiers, 750mA. Mixed volts	55p
H16	15	Experimenters' Pak of Integrated Circuits. Data supplied.	55p
H17	20	3 amp. Silicon Stud Rectifiers, mixed volts	55p
H20	20	BY126/7 Type Silicon Rectifiers 1 amp plastic. Mixed volts	55p
H34	15	Power Transistors, PNP, Germ. NPN Silicon TO-3 Can.	55p

MAKE A REV COUNTER FOR YOUR CAR

The 'TACHO BLOCK'. This encapsulated block will turn any 0-1mA meter into a linear and accurate rev. counter for any car with normal coil ignition system.

£1.10 each



OVER

1,000,000

TRANSISTORS IN STOCK

We hold a very large range of fully marked, tested and guaranteed transistors, power transistors, diodes and rectifiers at very competitive prices. Please send for free catalogue.

Silicon planar plastic transistors. Unmarked, untested factory clearance. A random sampling showed these to be of remarkably high quality.

Audio PNP, similar to ZTX500, 2N3702/3, BCY70 etc.
 Audio NPN, similar to ZTX300, 2N3708/9, BC107/8/9, BC168/9 etc.
 Please state Audio NPN or Audio PNP when ordering.

ALL AT 500 for £3.30, 1,000 for £5.50, 10,000 for £44 P. & P. 11p/1,000.

OUR VERY POPULAR 4p TRANSISTORS

TYPE "A" PNP Silicon alloy, TO-5 can.
 TYPE "B" PNP Silicon, plastic encapsulation.
 TYPE "E" PNP Germanium AF or RF.
 TYPE "F" NPN Silicon plastic encapsulation.
 TYPE "G" NPN silicon similar ZTX 300 range
 TYPE "H" PNP silicon similar ZTX 500 range

8 RELAYS FOR VARIOUS TYPES £1.10
 P & P 27½

Our famous PI Pak is still leading in value for money.

Full of Short Lead Semiconductors & Electronic Components, approx. 170. We guarantee at least 30 really high quality factory marked Transistors PNP & NPN, and a host of Diodes & Rectifiers mounted on Printed Circuit Panels. Identification Chart supplied to give some information on the Transistors. Please ask for Pak P.I. Only 55p. 11p P & P on this Pak.



A CROSS HATCH GENERATOR FOR £3.85 !!!

YES, a complete kit of parts including Printed Circuit Board. A four position switch gives X-hatch, Dots, Vertical or Horizontal lines. Integrated Circuit design for easy construction and reliability. This was a project in the September 1972 edition of Television. This complete kit of parts costs £3.85, post paid.

A MUST for Colour T.V. Alignment.

ELECTRONIC TRANSISTOR IGNITION

Now in kit form, we offer this "up to the minute" electronic ignition system. Simple to make, full instructions supplied with these outstanding features:—
 Transistor and conventional switchability, burglar proof lock up and automatic alarm, negative and positive compatibility. This project was a "star" feature in the September edition of "Electronics Today International" magazine. Our kit is recommended by the ETI magazine.

Complete kit including p & p £7.92
 Ready built and tested unit £3.02 extra.

FREE CATALOGUE FOR



TRANSISTORS, RECTIFIERS, DIODES, INTEGRATED CIRCUITS, FULL PRE-PAK LISTS

PLASTIC POWER TRANSISTORS

NOW IN TWO RANGES

These are 40W and 90W Silicon Plastic Power Transistors of the very latest design, available in NPN or PNP at the most shatteringly low prices of all time. We have been selling these successfully in quantity to all parts of the world and we are proud to offer them under our Tested and Guaranteed terms.

Range 1. VCE. Min 15. HFE Min 15.
 40 Watt 1-12 13-25 26-50
 22p 20p 18p
 90 Watt 24p 24p 22p
 Range 2. VCE. Min 40. HFE Min 40.
 40 Watt 1-12 13-25 26-50
 33p 31p 29p
 90 Watt 38p 36p 33p
 Complementary pairs matched for gain at 3 amps. 11p extra per pair. Please state NPN or PNP on order.

INTEGRATED CIRCUITS

We stock a large range of I.C.s at very competitive prices (from 11p each). These are all listed in our FREE Catalogue, see coupon below.

METRICATION CHARTS now available

This fantastically detailed conversion calculator carries thousands of classified references between metric and British (and U.S.A.) measurements of length, area, volume, liquid measure, weights etc. Pocket Size 15p. Wall Chart 18p.

LOW COST DUAL IN LINE I.C. SOCKETS

14 pin type at 16p each } Now new low profile 16 pin type at 18p each }

BOOKS

We have a large selection of Reference and Technical Books in stock. These are just two of our popular lines:

B.P.I. Transistor Equivalents and Substitutes 40p
 This includes many thousands of British U.S.A., European and C.V. equivalents.
The Iliffe Radio Valve & Transistor Data Book 9th Edition, p & p 231p 75p
 Characteristics of 3,000 valves and tubes, 4,500 Transistors, Diodes, Rectifiers and Integrated Circuits.

Send for lists of publications
 N.B. Books are void of V.A.T.

Please send me the FREE Bi-Pre-Pak Catalogue.

NAME

ADDRESS

ALL PRICES INCLUDE 10% VAT
 MINIMUM ORDER 50p. CASH WITH ORDER
 PLEASE. Add 11p post and packing per order
 OVERSEAS ADD EXTRA FOR POSTAGE
 BUY THESE GOODS WITH ACCESS.

BI-PRE-PAK LTD

CO. REG. No. 820919

DEPT. D, 222-224 WEST ROAD, WESTCLIFF-ON-SEA, ESSEX S50 9DF
 TELEPHONE: SOUTHEND (0702) 46344

NELSON-JONES FM TUNER KIT



VARICAP TUNING

as in 'W.W.' June '73

Now available to readers of 'Practical Wireless'. The Nelson-Jones tuner uses dual gate MOSFET's in the RF stages, integrated circuits and ceramic filters in the IF stages, for very high performance and quick assembly. Do not confuse with tuners using only bipolar transistors and IF coils!

Tuning is accomplished by variable capacitance diodes and a Push Button Unit with 6 positions. AFC disable is incorporated as well as a pointer for each button showing tuning position in the range 87.5-108MHz, i.e. each 'button' is fully tuneable simply by turning.

Our complete metalwork system is supplied with nuts, bolts, board standoffs, push button mains on/off and stereo mute assembly, sockets, fuse and holder. Printed and Anodised Front Panel and Veneered Teak case. Power supply kits are supplied with complete kits of parts, or separately. LED tuning ind. is also supplied.

Prices for complete kits start at £23.95 + 50p pp. + VAT for mono tuners, (phase locked decoders are also available to fit in the cabinet). Please send large SAE for complete details of special offers and our complete lists.

GREEN LED's—the latest for 'stereo' lamps. 1-9 69p, 10+ 59p.

TEXAN AMPLIFIER

The Cabinet of the Nelson-Jones Tuner is specially designed to match the Texan amplifier cabinet, see photographs, so that owners of Texan's are assured of compatibility, both in superb performance and appearance.

Texan amplifier kits are available at £28.50 + 50p pp. + VAT.

Worried about tuner alignment? then let our alignment service take over.

Telephone queries. We have REAL ENGINEERS, not salesmen, to answer queries.



INTEGRIX LIMITED, Dept. P.W., P.O. Box 45, Derby, DE1 1TW. Tel. Repton (028389) 3580

G. F. MILWARD 369 Alum Rock Road, Birmingham B8 3DR.

Tel. 021-327 2339

NEW! NEW! NEW! NEW!

An aerosol spray providing a convenient means of producing any number of copies of a printed circuit both simply and quickly.

Method: Spray copper laminate board with light sensitive spray. Cover with transparent film upon which circuit has been drawn. Expose to light (No need to use ultra-violet.) Spray with developer, rinse and etch in normal manner. Light sensitive aerosol spray £1.00 plus developer and Etchant 50p postage

NEWER THAN NEW!!!

Fibre Glass Board pre-treated with light-sensitive lacquer enabling you to produce prototype printed circuits within five minutes.

75mm x 100mm 33p
150mm x 100mm 66p
150mm x 200mm £1.32

SILICON N.P.N.

Type	Volts	Frequency	Price	Type	Volts	Frequency	Price
BC 108	30	150 MHz	10p	2N 697	60	40 MHz	12p
BC 109	30	150 MHz	10p	2N 709	15	900 MHz	30p
BF 79	225	125 MHz	40p	2N 718	60	60 MHz	12p
BF 180	30	625 MHz	25p	2N 753	25	250 MHz	12p
BFW 58	80	80 MHz	15p	2N 744	20	300 MHz	12p
BFX 43	30	500 MHz	20p	2N 1613	75	60 MHz	17p
BFX 86	40	50 MHz	17p	2N 2220	60	250 MHz	15p
BFY 53	30	50 MHz	10p	2N 3053	60	100 MHz	17p
BSX 19	40	500 MHz	10p	2N 3707	30	100 MHz	12p
BSX 67	30	200 MHz	12p	2N 5179	20	900 MHz	40p

SPECIAL OFFER

Uni-Junction Transistor Similar to 2N2646—25p

POSTAGE (MINIMUM) 20p PER ORDER

ALL GOODS 10% V.A.T.

MICROWAVE DEVICES

CL 8300	Gunn effect oscillator	9-4 GHz	£40
CL 8370	ditto	9-5 GHz	£10
CL 8380	ditto	10-5 GHz	£10
CL 8390	ditto	11-5 GHz	£10
CL 8430	ditto	9-35 GHz	£40
CL 8450	ditto	9-35 GHz	£40
CL 8470	ditto	9-35 GHz	£40
BXY 27	Varactor Diode. "S" Band. Cut-off	70 GHz	£1
BXY 28	Varactor Diode. Cut-off	100 GHz	£1
BXY 32	Frequency Multiplier. "X" Band	150 GHz	£1
BXY 35A/C	ditto	25 GHz	£1
BXY 36C/D	ditto	75 GHz	£1
BXY 37C/D	ditto	100 GHz	£1
BXY 38C/E	ditto	120GHz	£1
BXY 39C/D	ditto	150 GHz	£1
BXY 40D/E	ditto	180 GHz	£1
BXY 41C/D/E	ditto	200 GHz	£1
2N 2777 (AAV 51)	Microwave Mixer Diode	18 GHz	£2
CAY 10	Microwave Detector Diode	250 GHz	£5
AEY 13	Microwave Tunnel Diode	6 GHz	£5
AEY 16	ditto	10 GHz	£10
AEY 17	Microwave Detector	18 GHz	£3
AEY 31A	ditto	18 GHz	£3
BAW 95	Schottky Barrier Diode	12 GHz	50p

SILICON P.N.P.

Type	Voltage	Frequency	Price
BCY 71	45	200 MHz	12p
BFS 92	100	70 MHz	20p
BFS 95	40	70 MHz	17p
BFX 12	25	210 MHz	10p
2N 2006	60	200 MHz	15p
2N 3702	40	100 MHz	11p
2N 3703	50	100 MHz	12p
BFR 64	40	1,200 MHz	£1
BLY 89A	35	650 MHz	£5
BLY 93A	60	500 MHz	£5
BLY 218	35	1,200 MHz	£2
2N 709	15	800 MHz	15p
2N 3926	36	250 MHz	£1

HIGH FREQUENCY, POWER

BFR 64	40	1,200 MHz	£1
BLY 89A	35	650 MHz	£5
BLY 93A	60	500 MHz	£5
BLY 218	35	1,200 MHz	£2
2N 709	15	800 MHz	15p
2N 3926	36	250 MHz	£1

GERMANIUM P.N.P.

Type	Voltage	Frequency	Price
ACY 44	50	1 MHz	10p
ADY 26	80	75 watts	£1
AF 124	20	75 MHz	20p
AFY 19	32	350 MHz	20p
ASY 32	25	5 MHz	10p
ASZ 21	15	450 MHz	20p
GET 113	32		10p
GET 120	32	2 watts	10p
OC 123	50	1 MHz	10p
OCP 70		Light-sensitive	20p
2N 1307	30	10 MHz	15p
2N 1309	30	15 MHz	15p
2N 443	60	150 watts	£1

£1 100 1/2 WATT RESISTORS
100 CERAMIC CAPACITORS
100 DIODES

POSTAGE 20p | PACK No. 1

£1 1 VERO-BOARD CUTTER
5 1/2 in. x 1 in. x 15 BOARDS
50 CERAMIC CAPACITORS
50 "ODD PIECES" VERO

POSTAGE 20p | PACK No. 3

£1 20 ASSORTED UNUSED
MARKED, TESTED
TRANSISTORS
BC108 ETC.

POSTAGE 20p | PACK No. 5

£1 6 COMPUTER PANELS
CONTAINING MASSES OF
DIODES, TRANSISTORS,
INDUCTORS, RESISTORS
& CAPACITORS

POSTAGE 27p | PACK No. 7

£1 100 RESISTORS
100 CERAMIC CAPACITORS
100 POLYSTYRENE CAPACITORS

POSTAGE 20p | PACK No. 2

£1 100 RESISTORS
100 CERAMIC CAPACITORS
50 MULLARD POLYESTER CAPACITORS

POSTAGE 20p | PACK No. 4

£1 1 TRANSISTORISED
SIGNAL TRACER KIT
1 TRANSISTORISED
SIGNAL INJECTOR KIT

POSTAGE 20p | PACK No. 6

£1 100 RESISTORS
100 CAPACITORS
(ASSORTED TYPES)

POSTAGE 20p | PACK No. 8

RECORD PLAYBACK HEADS (TRUVOX)

Individual prices of these are:—
2 track record playback heads 50p each
4 track record playback heads 72p each
Erase heads are also available separately—2 track 33p—4 track 55p
MU-metal mounting shields 39p each
2 track-heads already fixed on heavy mounting plate with shield £1.22.

DRILL CONTROLLER NEW IKW MODEL

Electronically changes speeds from approximately 10 revs to maximum. Full power at all speeds by finger-tip control. Kit includes all parts, case, everything and full instructions. £1.95.
Made up model also available. £2.95.

MIGHTY MIDGET

Probably the finest possible radio, as described in *Practical Wireless*, January 73. All electronic parts £2.20 post paid.

TIME SWITCH

Smith's mains driven clock with 15 amp switch, also notes showing how you can wake up with music playing, kettle boiling or come home to a warm house, warn off burglars, keep pets warm, have your heating bill, etc. £1.95.

I CHIP RADIO

Ferranti's latest device ZN414—gives results better than superhet. Supplied complete with technical notes and circuits. £1.38 each. 10 for £11.11.

HI-Q TUNER COMPONENTS

For experimenting with the ZN414.
KIT NO. 1. Plessey Miniature Tuning Condenser with built-in LW switch and 3" Ferrite slab and litz wound MW coil, 72p.
KIT NO. 2. Air spaced tuning condenser 6" ferrite rod litz wound MW and LW coils. 94p.
KIT NO. 3. Air spaced TC with slow motion drive 8" ferrite rod, with litz wound LW and MW coils. £1.10.
KIT No. 4. Permeability tuner with fast and slow motion drive and LW loading coils. 50p.

AUTO-ELECTRIC CAR AERIAL

With dashboard control switch—fully extendable to 40in or fully retractable. Suitable for 12V positive or negative earth. Supplied complete with fitting instructions and ready wired dashboard switch. £6.85 plus 25p post and insurance.

TELESCOPIC AERIAL

for portable, car radio or transmitter. Chrome plated—six sections, extends from 7 1/2 to 47in. Hole in bottom for 6BA screw, 42p. KNUCKLED MODEL FOR F.M. 65p.

EXTRACTOR FAN

Cleans the air at the rate of 10,000 cubic ft. per hour. Suitable for kitchens, bathrooms, factories, changing rooms, etc. It's so quiet it can hardly be heard. Compact, 5 1/2" casing with 5 1/2" fan blades. Kit comprises motor, fan blades, sheet steel casing, pull switch, mains connector, and fixing brackets. £2.75 plus 20p post and ins.

MAINS OPERATED SOLENOIDS

Model 772—small but powerful 1in. pull—approx size 1 1/2 x 1 1/2 x 1 1/2in. 66p.
Model 4001—1in. pull. Size 2 1/2 x 2 x 1 1/2in. 88p.
Model FT1—1 1/2in. pull. Size 3 x 2 1/2 x 2in. £1.98 plus 20p post and insurance

MAINS TRANSISTOR POWER PACK

Designed to operate transistor sets and amplifiers. Adjustable output 6v., 9v., 12 volts for up to 500mA (class B working). Takes the place of any of the following batteries: PP1, PP3, PP4, PP6, PP7, PP9, and others. Kit comprises: mains transformer rectifier, smoothing and load resistor condensers and instructions. Real snip at only £1.10 plus 20p postage.

DESK TELEPHONES

Ex G.P.O. Black standard model with dialling dial but no internal bell. Supplied with connection diagram £1 each. Ditto with bell but without dialling dial £1.25 model as illustrated with bell and dial £1.50 each plus 50p post single then 65p per pair.

SMOKE WILL KILL—GAS WILL KILL—FIRE WILL KILL

But, if you install SAGA (our smoke and gas alarm) your family will have the latest electronic protection against these killers. SAGA uses a fantastic electronic sensor which "smells" smoke and gas and sounds the alarm immediately. In a neat case measuring approx. 5" x 3 1/2" x 2 1/2", it has its own internal alarm, also a connector for additional bells. You just plug it in to the mains and hang it near the ceiling. SAGA uses so little electricity that it will hardly move the meter, leave it on all ways to give night and day protection. £2.99 plus 30p post or Kit of Parts £2.99. Battery Model Kit only £4.99.

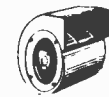

CENTRIFUGAL FAN

Mains operated, turbo blower type. Pressed steel housing contains motor and impeller. Motor is 1/10th h.p. giving considerable air flow but virtually no noise. Approx. dimensions 10 1/2 in. wide x 12 in. dia. outlet into trunking 10 1/2 x 4 1/2 in. £6.55 plus 21p post and insurance.

STANDARD WAFER SWITCHES

Standard size 1 1/2" wafer—silver-plated 5 amp contact, standard 1/2" spindle 2" long—with locking washer and nut.

No. of Poles	2way	3way	4way	5way	6way	8way	9way	10way	12way
1 pole	44p	44p	44p	44p	44p	44p	44p	44p	44p
2 poles	44p	44p	44p	44p	44p	44p	44p	44p	44p
3 poles	44p	44p	44p	44p	44p	44p	44p	44p	44p
4 poles	44p	44p	44p	44p	44p	44p	44p	44p	44p
5 poles	44p	44p	44p	44p	44p	44p	44p	44p	44p
6 poles	44p	44p	44p	44p	44p	44p	44p	44p	44p
7 poles	44p	44p	44p	44p	44p	44p	44p	44p	44p
8 poles	44p	44p	44p	44p	44p	44p	44p	44p	44p
9 poles	44p	44p	44p	44p	44p	44p	44p	44p	44p
10 poles	44p	44p	44p	44p	44p	44p	44p	44p	44p
11 poles	44p	44p	44p	44p	44p	44p	44p	44p	44p
12 poles	44p	44p	44p	44p	44p	44p	44p	44p	44p

TWENTYLITE

Fluorescent lighting units with polyester choke and finished white enamel. 2ft. model. Ideal kitchen, bedroom, hallway, porch, lift, etc., with tube. Assembled ready to install. Price £2.50 + 25p p. & p.

RADIO STETHOSCOPE

Easiest way to fault find—traces signal from aerial to speaker—when signal stops you've found the fault. Use it on Radio, TV, amplifier, anything—complete kit comprises two special transistors and all parts including probe tube and crystal earpiece. £2.20—twin set—instead of earpiece 85p. extra—post and ins. 20p.

TANGENTIAL HEATER UNIT

This heater unit is the very latest type, most efficient, and quiet running. Is as fitted in Hoover and blower heaters costing £15 and more. We have a few only. Comprises motor, impeller, 2kw. element and 1kw. element allowing switching 1, 2 and 3kw. and with thermal safety cut-out. Can be fitted into any metal line case or cabinet. Only needs control switch. £2.85, 2kw. Model as above except 2kw. £2.75. Don't miss this. Control Switch 30p, P. & P. 40p.

ROOM THERMOSTAT. Made by the famous Smiths Company. 15 amp. at 250v. Elegant white and beige case, size 4 1/2 inches long by 1 1/2 square approx. Adjustment is by slider (lockable) adjusts through range 30°—90°F. Special 81p price £1.95

CAPACITOR DISCHARGE CAR IGNITION

This system which has proved to be amazingly efficient and reliable was first described in the *Wireless World* about a year ago. We can supply kit of parts for an improved and even more efficient version (*Practical Wireless*, June). Price £6.55 plus 20p post. When ordering please state whether for positive or negative systems. De-luxe model including printed circuit board, etc. £7.95.

24-HOUR TIME SWITCH

Made by Smiths, these are AC mains operated, NOT CLOCKWORK. Ideal for mounting on rack or shelf or can be built into box with 13A socket. Two completely adjustable time periods per 24 hours. 5A changeover contacts will switch circuit on or off during these periods. £2.75 post and ins. 25p. Additional time contacts 65p pair.

PHOTO ELECTRIC KIT

Contains photo cell, relay, transistor and all parts to make light operated switch. £1.75 plus 20p post and ins.

MULLARD UNILEX STEREO AMPLIFIER

We demonstrate these daily and almost always a sale results; it really is a cracking amplifier. Only Mullard with their know how could have made it possible at this low price. SPEC. Mains operated. 4 watts music or speech per channel. Double wired power supply eliminates cross talk. Harmonic distortion less than 2%. Frequency response 60hz-16Khz. Input suitable for pick-up tuner or microphone. 6 month guarantee. Only £11.30 post paid, pair of ohm speakers £3.80.

TERMS: 10% discount if ten of an item ordered, send postage where quoted—other items, post free if order for these items is £6.00 otherwise add 20p.

NEW ITEMS THIS MONTH

White Rocker Switches. Four types available, all snap in fixing through oblong hole approx. 1" x 3/4", all rated at 10 amps AC. All have white rocker except S3, which is amber.
Our ref RS S1, push to make, spring return, 14p.
Our ref RS S2, push to break, spring return to on, 14p.
Our ref RS S3, change over contacts, luminous rocker, 28p.
Our ref RS S4, change over contacts, normal rocker, 16p.

Rocker Switches. 15 amp Britnac panel mounting, hole size 1 1/2 x 1. Our ref RS S5 price 11p each. 6 amps made by Mem, their type ref 1600, our ref RS S6, price 11p each.

Miniature Hand Microphone. Dynamic, for tape recorders but equally suitable for amplifiers, good quality with lead and plug, price £1.87.
Open Coil Relays. All with 10 amp change over contacts, all brand new.

Our ref REL S1, 12 volt DC coil, double pole, 44p.
Our ref REL S2, 110 volt AC coil, treble pole, 44p.
Our ref REL S3, 250 volt AC coil, treble pole, 55p.

Photo Transistor Bargain. First class make but slightly reject, covered, however, by our normal six month guarantee, these respond to light or infra red. Will work a burglar alarm system, make detector counter etc. Price 25p complete with three circuits.

Mains Flex. Padded, circular, cotton covered overall. 8ix amp (23-36) 100 yard coils. Price £2.75 plus 50p post.

Screened Cable. 70076 core suitable for pick up or mike lead or for inter-connecting amplifiers. 10 metres, 35p.

Stereo Pre-amp Module. Mullard ref LP 7182/2—transistors and all ancillary components mounted on PC board, £1.32 with connection dig.

GOOD COMPANION I.C. VERSION

We can now offer these again in I.C. version using Ferranti ZN414 and Mullard AF Module 1172. Cabinet size approx. 11" wide x 8" high x 3" deep. Complete assembly instruction. Excellent tone wood cabinet. £2.75 plus 25p post and insurance.

MOTORS FOR £1.50

As used in racing cars and power models. All battery operated and reversible.

RESISTANCE WIRE

Mainly Nickel Chrome. (Resistances 74 ohms per metre down to 1 ohm per metre). Price 10p per oz. on catch weight reels—so please send an open cheque—we will send the smallest reel over the quantity you want and make your cheque out for the quantity sent. You return the "over" amount within 1 month and we will refund for the amount you return. 25p returnable charge for reel.
Special Offer. 1 yard of 1.1mm wire. This is almost exactly 1 ohm. 10p.

PC BOARD MARKER

Valve action fire tipped marking pen filled with black etch resist—it's easy with this to make a perfect PC board, just draw straight on to the copper—allow 15 mins. to dry, then immerse in ferrous chloride or other etchant on removal the circuit stands in high relief. 60p.

SL108D. Plessey IC, three watt amplifier which works with the Ferranti ZN414 to become probably the first two IC radio in existence, the circuit and constructional details appeared in September's *Practical Wireless*, so we can supply the SL108D at £1.75. The ZN414 at £1.85 also most other items, send for PW IC radio parts list.

EDUCATIONAL KITS—all with pictorial instructions

With 3 kits or more we give FREE an accurate 11 piece balance kit. Price of kits 44p each post paid. Special price for all 7 kits £3.00 with free balance kit.

- KA2 Lens Kit. Eleven parts, concave lens, one convex lens, stage and slit frame, etc.
- KA3 Water Pump Kit. Thirteen parts. Transparent so that operating parts may be observed. You can make Lift Pump, Force Pump and Force Pump with reservoir and nozzle.
- KA4 Buzzer Kit. Eleven parts. Operation of buzzer seen.
- KA7 Electro-Magnet Kit. Fifteen parts, includes compass, showing how magnetism works.
- KA8 Current and Resistance Kit. Twenty-nine parts, including bench and light bulb. Learn "OHMS LAW", etc.
- KA9 Bell Kit. Eight parts, including bell and push button switch. Build a complete electric bell.
- KA10 Morse Key buzzer and bell kit. 25 part kit easy to construct, simple to operate.

J. BULL (ELECTRICAL) LTD.
(Dept. P.W.) 7 Park Street, Croydon CRO 1YD
Callers to: 102/3 Tamworth Road, CROYDON

Henry's

PANEL METERS · TRANSFORMERS · CONTROLS · RELAYS
 IRONS · TOOLS · VALVES · POT CORES MOST TYPES OF COMPONENTS
 You need a catalogue! 55p post paid complete with Discount Vouchers

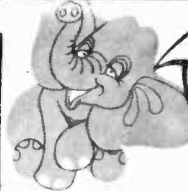

UK's
**LARGEST RANGE
 OF KITS &
 GADGETS**

TEST EQUIPMENT

MULTIMETERS

(carr. etc. 30p)

200H (M210) 20K/Volt Slimline with case	4-95
TLH33D 2K/Volt Robust with case	4-95
U437 10K/Volt Steel case. AC up to 40 KHz	4-95
U4324 20K/Volt with AC current ranges	8-00
AF105 50K/Volt with Leather case	9-50
U4313 20K/Volt AC current. Steel case	10-50
U4341 Plus Built in transistor tester	10-50
Model 500 30K/Volt	9-95



OTHER EQUIPMENT

SE250B Pocket Signal Injector	1-90 carr. 15p
SE500 Pocket Signal Tracer	1-50 carr. 15p
TE15 Grid Dip meter 440kHz-280mHz	13-45 carr. 30p
TE40 AC Millivoltmeter 1-2mHz 18-75 carr. 35p	
TE65 28 Range valve voltmeter	19-25 carr. 40p
TE20 120kHz-500mHz RF Generator	16-95 carr. 40p
TE22D 20Hz-200kHz Audio Generator	18-75 carr. 40p
SE350A Deluxe Signal Tracer	9-95 carr. 20p
SE400 Volts/ohms/R-C sub./RF field/RF gen.	11-25 carr. 20p

New Revolutionary Supertester 680R

Accessories

680R Multi-tester	18-50
Transistor tester	11-00
Electronic voltmeter	18-00
Ampclamp	11-95
Temperature probe	11-95
Gauss meter	11-95
Signal Injector	5-95
Phase Sequence	5-95
EHT Probe	5-95
Shunts 25/50/100A	4-50 each

A SELECTION OF INTERESTING ITEMS

C3025 Compact transistor tester	5-50 p & p 15p
E1300 Mono mag. cart. preamp.	1-95 p & p 15p
E1310 Stereo mag. cart. preamp.	4-95 p & p 25p
Easiphone telephone amplifier	6-15 p & p 25p
D1203 Telem. with PU coil	3-60 p & p 20p
LL1 Door Intercomm. and chime	11-95 p & p 25p
Chattelle (lights as you talk)	13-90 p & p 20p
1 Kw Dimmer/controller	3-00 p & p 10p
9" Twin spring unit	2-75 p & p 15p
16" Twin spring unit	6-50 p & p 25p
Car Tachometer Electronic	7-50 p & p 15p
VHF 105 Aircraft Band Corrector	3-95 p & p 15p
B2005 4 Ch. mic. mixer	2-95 p & p 15p
B2004 2 ch. Stereo mixer	4-75 p & p 15p

BUILD THIS RADIO

Portable MW / LW radio kit using Mullard RF/IF module. Features MW — bandspread for extra selectivity. Slow motion tuning. Fibreglass PVC cabinet. 600mW output. All parts £7-98 (battery 22p), carr. etc. 32p

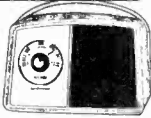

EXCLUSIVE: SPECIAL OFFERS

MW/LW CAR RADIO AKAI GX40
 or — Earth with speaker Stereo cassette recorder, and fixings. £6-50 carr./£58-95 carr./pack. 50p.
 Pair Akai ADM microphones. £6-95 carr./pack. 20p.

8 TRACK CAR STEREO
 (— Earth) with speakers in 5 WAVEBAND PORTABLE TWIN SPEAKER RADIO. FM/MW/SW/AIRCRAFT—PUBLIC SERVICES. £10-45 carr./pack. 20p.

HANIMAX HC1000
 Battery cassette recorder. PORTABLE CASSETTE TAPE PLAYER— for car or carry around. £7-25 carr./pack. 20p.

HANIMAX HC2000
 Battery/Main cassette re-corder. £13-50 carr./pack. 30p.

HANIMAX CALCULATOR POCKET % KEY. £33-50

SPECIAL PURCHASES

AVOMETER MOVEMENTS
 AVO 8 or 9 50µA MOVE-MENTS. Ex Brand New AVO's £3-50 Post 20p.

UHF TV TUNERS CHANNELS 21 TO 64
 Brand new transistorised geared tuners for 625 Line Receiver IF output. £2-50 Post 20p.



EASY TO BUILD KITS BY AMTRON—EVERYTHING SUPPLIED

Model No.		
310 Radio control receiver		2-98
300 4-channel R/C transmitter		5-95
345 Superhet R/C receiver		5-95
455 AM signal generator		12-33
65 Simple transistor tester		1-40
115 8 watt Amplifier		3-90
120 12 watt amplifier		4-70
125 Stereo control unit		5-70
130 Mono control unit		3-60
605 power supply for 115		4-55
610 power supply for 120		4-75
615 Power supply for 2 & 120		5-73
230 AM/FM aerial amplifier		2-93
240 Auto parking light		5-90
275 Mic. preamplifier		6-08
570 LF generator 10Hz-1mHz		15-80
575 Sq. wave generator 20Hz-20KHz		14-60
590 SWR meter		12-85
620 Ni-CAD Charger 1-2-12v		8-00
630 STAB Power supply 6-12v 0-25-0-1A		8-15
690 DC motor speed Gov.		2-87
700 Electronic Chaffinch		7-00
705 Winder/wiper timer		6-80
760 Acoustic switch		10-75
785 Metal Detector (electronics only)		9-65
790 Capacitive Burglar alarm		6-85
835 Guitar preamp.		4-25
840 Delay car alarm		6-15
875 CAP. Discharge ignition for car engine (-Ve Earth)		13-15
80 Scope Calibrator		2-25
255 Level Indicator		6-15
525 120-160mHz VHF timer		11-30
715 Photo cell switch		7-70
795 Electronic continuity tester		4-30
860 Photo timer		13-25
871 Slide projector auto feed control		7-15
225 Acoustic Alarm for driver		7-60
485 Quartz XTAL checker		8-75
230 Signal injector		2-30
350 VOX		15-50
432 Testkit		19-30
670 Buffer Battery Charger		6-55
885 Capacitive Contact Alarm		6-25
850 Electronic Keyer		18-75
820 Electronic Digital Clock		58-50

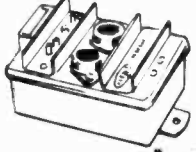

ALL KITS OFFERED SUBJECT TO STOCK AVAILABILITY

BUILD THIS TUNER

MW/LW Radio Turner to use with any amplifier. Features Mullard RF/IF module Ferrite aerial, built in battery. Excellent results. Size 7" x 2 1/2" x 3 1/2". All parts £4-85, carr. 15p.



MULTI-USE & RADIONIC KITS

10-1 10 Projects	3-80
50-1 10 Projects	8-00
150-1 150 Projects	13-20
Telephone Communicator	7-20
X20 20 (Elec.) Projects	4-95
X40 40 (radio) Projects	9-45

All transistor circuits with hand books

All types offered subject to availability. Prices correct at time of press E & OE. 10% VAT TO BE ADDED TO ALL ORDERS. UK post etc. 15p per order unless stated.

GARRARD BATTERY TAPE DECK

GARRARD 2 speed 9 volt tape decks. Fitted record/play and oscillator/Eraser heads. Wind and rewind controls. Takes up to 4" spools. Brand new complete with head circuits. £9-50 carr. 30p

TOP QUALITY SLIDER CONTROLS

60mm stroke high quality controls complete with knobs (post. etc. 15p any quantity).

MARRIOT TAPE HEADS

4 TRACK MONO or 2 TRACK STEREO '17' High Impedance £2-00 '18' Med. Impedance £2-00

Singles Log and Lin 5K, 10K, 22K, 50K, 100K, 250K, 500K, 1 Meg. 45p each.

R730/E73 2 track mono Record/Eraser low Imp. 75p pair. Erase Heads for '17' and '18' 75p '63' 2 track mono, Hi Imp. £1-75 '43' Erase Head for '63' 75p

Ganged Log and Lin 10K, 22K, 50K, 100K, 250K-85p each.

(Post, etc. 15p any quantity).

SINCLAIR, MINIATURE AMPLIFIERS & TUNER/DECODER

AMPLIFIERS (carr. etc. 20p)

4-300, 0-3 watt 9 volt	1-75
104, 1 watt 9 volt	2-20
304, 3 watt 9 volt	2-50
555, 3 watt 12 volt	2-85
E1208, 5 watt 12 volt	4-50
608, 10 watt 24 volt	4-10
410, 10 watt 28 volt	4-95
E230, 15 watt 30 volt	9-75
E1206, 30 watt 45 volt	3-50
Z50, 30 watt 50 volt	4-37
E1210, 2 1/2 + 2 1/2 watts	5-25
RE500, 12 watt IC mains operated Amplifier with controls	£6-30
SAC14, 7 + 7 watt Stereo with controls	£8-00
SAC13, 15 + 15 watt Stereo with controls	£11-00

SINCLAIR PROJECT (carr. 20p)

Z30-3-57	Z50 4-37
Stereo 60 Preamp	7-97
PZ5 £3-97, PZ6 £6-37	
PZ8 (for Z50) £4-77	
(TRANS £2-95)	
AFU £4-45	

New SINCLAIR PROJECT 80

Stereo Preamp.	9-50
Audio Filter Unit	5-50
Z40 15 Watt Amp.	4-30
Z60 25 Watt Amp.	5-50
PZ5 Mod. for 1 on 2 Z40	3-98
PZ6 Mod. (S Tab)	6-25
PZ8 Mod. (S Tab)	6-30
1 on 2 Z60	6-30
TRANSFORMER FOR PZ8	2-95
Project 605 Kit	19-95

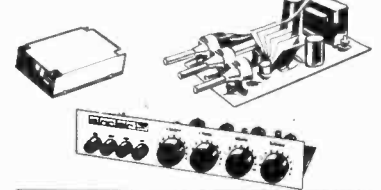

POWER SUPPLIES FOR EVERY PURPOSE

(All cased unless stated chassis)

470C 6.7/9 volt 300 MA (includes Multi-Adaptor for Tape Recorders, etc.)	1-95 post 20p
Car Lighter Voltage Adaptors 300mA (State voltage 6v, 7.5v, 9v)	1-95 ea. post 25p
SC202 3/6/7/9 volt 400mA	3-25 carr. 30p
HC244R Stabilised version	4-25 carr. 30p
P500 9 volt 500mA	2-80 post 20p
P11 24 volt 500mA (chassis)	2-80 post 20p
P15 25/28 volt 1 amp (chassis)	2-70 post 20p
P1080 12v 1 amp (chassis)	3-25 post 20p
P1081 45v 0-9 amp (chassis)	4-40 post 20p
P12 4+12 volt 0-4-1 amp	6-75 post 20p
SE101A 3/6/9/12 volt 1 amp (Stab.)	9-15 post 25p
RP164 6/7.5/9/12 1 amp (Stab.)	9-95 post 30p

FIBRE OPTICS
 0-01 Diam. Mono Filament £1-50 per 25 metre reel
 0-13 Diam. 64 Fibres Sheathed. £1-00 per metre
 SPRAYS 15mm Diam. Mares Tails £9-50.

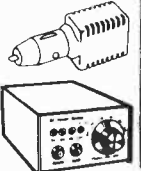

Henry's RADIO LIMITED
 EDGWARE ROAD, W2

SEE FACING PAGE FOR ADDRESSES

FREE

in the December 'Practical Motorist'

2 Instant OIL FUNNELS

Keep them in the glove box of your car to fit together when you have to top up the oil and your proper funnel is at home in the garage.

Highlights in this gift issue

Tackling winter hazards—extras to carry to make bad weather motoring easier. Review of de-misting devices now available. Replacing the syncromesh in a Herald gearbox. Impression test of the new Cortina 2000E and 1600cc.



Don't miss the December issue of

PRACTICAL motorist

NOW ON SALE 15p

QUALIFY TO EARN MORE MONEY In a better job

Exciting new career opportunities! They're just waiting to be grasped — in the ever-growing industries of electronics, radio and television. And with ICS behind you, you can soon win the qualifications you need to assure your career success. Win them in your own time, in your own home, by starting an ICS learn-as-you-earn correspondence course now. You get personal, individual attention from really expert and experienced tutors. We teach you the theory, we teach you the practice. Books and components are provided. So is all the assistance, all the backing you need.

We also have a complete range of courses at the ready for people keen to score success in other fields. Whatever qualification you're after, we can help you get it, whether you're pushing ahead where you are or switching to something completely new.

Take your first step now towards a better paid, more assured future. Send for your FREE Careers Guide today.

Take one of these courses

Society of Engineers Graduateship (Electrical Engineering)
G & G Telecommunications Technicians Certificates
C & G Electrical Installation Work
C & G Certificates in Technical Communication Techniques
C & G Radio Amateurs
MPT General Certificate in Radio Telegraphy
Audio, Radio and TV Engineering & Servicing
Electronic Engineering Maintenance, Engineering systems
Instrumentation & Control systems
Computer Engineering & Technology
Electrical Engineering, Installations, Contracting, Appliances
Self-build radio courses

... or take one of these if your future lies in other fields

GCE O and A Level

Basic foundation for success in a thousand and one careers—recognised by everybody. All Boards—64 subjects

Building

Tuition for recognised technical qualifications in all fields
Architecture
Builders Quantities
Carpentry, Joinery
Draughtsmanship
Quantity Surveyors
Clerk of Works
Heating, Ventilating

Engineering

Theoretical and practical tuition geared either to professional and technical examinations or to vocational (non-exam) courses
Mechanical, Motor, Diesel, Chemical
Welding
Refrigeration
Draughtsmanship
Garage Management

* Courses for appropriate professional exams available in addition to ICS Diploma courses.

Management, Marketing and Business

Instruction in the latest proved principles and techniques used in each highly specialised area.

- * Personnel
- * Administrative
- * Works
- * Transport
- * Business
- * Industrial
- * Sales
- * Marketing
- * Advertising
- * Marketing
- * Public Relations
- * Sales
- * Business
- * Computers
- * Purchasing
- * Book-keeping
- * Work Study
- * Storekeeping
- * Small Business Owners
- * Fire Service
- * Promotion and Institute of Fire Engineers
- * Police
- * Entrance and Promotion

FELSTEAD ELECTRONICS (PW 75) LONGLEY LANE, GATLEY, CHEADLE, CHES. SK8 4EE

Selection from our List, sent free for stamped addressed envelope. (Free overseas, and with all orders on request). Cash with order only—No C.O.D. or Bill service. Charges (Min. 7p) in brackets after all items apply to G.B. and Eire only. Regret orders under 30p plus charges unacceptable. S.A.E. please for enquiries or cannot be replied to. Overseas, including Eire and Channel Isles, orders less 10% off prices below, which include V.A.T. RECORDING TAPE: Finest quality/value British Mylar available: STANDARD 5" 600ft. 40p; 5 1/2" 900ft. 55p; 7" 1200ft. 62p; LONG PLAY 5" 900ft. 55p; 5 1/2" 1200ft. 41.00p (Charges for 5" and 5 1/2", singles 10p, two to four 9p each; five and over 33p the lot. For 7", one, two or three 12p each reel, 3, 4 and 6 reels 34p the lot, 6 reels and over 40p the lot). Other sizes and capacities in list. CASSETTES: Two types. Both in Library Cases, C90 33p, C90 45p, C120 72p. Deluxe Types: C60 55p, C90 72p, C120 99p. (Charges for both types, under 5, 9p each, 5 for 17p). All quantities over 5, 28p the lot.) CARTRIDGES all with standard fittings and stylus. Stereo-compatible Mono GP91/8C 99p; STEREO GP93 £1.85, Stereo Ceramic GP94 £1.75. Comparatives shown in List, with more types inc. Monotone 9TAHC, Stereo Ceramic Diamond £1.70 (All at 8p each). DIAMOND STYLUS: single tip types: Acos GP37, GP39, GP53/67, GP71, BSR TCR/LP/ST; COLLARD G.P. and DC284, GARRARD GC2, GC3, GC3B, GC3B1, GUEFFRÉ BF40, O.P. and T. PHILIPS 3301 (3060, 3068, 3302, 3304), 3010/12/13/16, SONOTONE 19T/20T ALL AT 36p each. SAPPHIRE 16p, DIAMOND DOUBLE TIP TURNOVER TYPES (78 rap. on other side). For ACOS GP73, GP91 (for cartridges GP93, GP94, etc.) GP918C (for stereo compat. types) GP104, BSR 8T4 (8T3, 8T5), 8T9 (8T8), 8T12/14/15, SONOTONE 8TA, 9TA, 9TAC. PHILIPS 3306, 3310, 3224, 3228/22, GP280, GARRARD GCM21, and 22, GC823, GK825 and 26, GCM21T and 22T, GCM24T, GC823, GK825 and 26T, GCM31, GC836, GC835, GC838, K840A, K841B, ETC. ALL AT 69p. SAPPHIRE 32p, DOUBLE DIAMOND STYLUS: same dia 8T/LP tip each side; no. 78) All types £1.85. SAPPHIRE DOUBLE 8T/LP, TIPPED 32p. DIAMOND STYLUS GOLD-RING REPLACEMENTS: G800, G800H & G850, £2.25 each, G800E £3.75 (All Stylus 9p up to 3). PICK-UP WIRE: super thin flex screened, sheathed, TWIN 7p per yard, 4-core 13p per yard, (either up to 6 yards, 7p). Over, charges paid. MICROPHONES: CRYSTAL LAPEL 1 1/2", clip/hand, lead 3-5mm jack plug 89p (10p). CM20 Cream Plastic hand 59p (10p); "MIC 45" Curved metal hand grip £1.10 (11p) ALL with leads. DYNAMIC: Excellent MIKE, 50K Ω, only 31mm long, black/chrome, switched, lead with 2.5 and 3.5 mm jack plug £1.37 (11p). Cardiol Ball, 50K/600 Ω built in volume control, on/off switch, special 20ft lead, the best value anywhere at £6.00 (33p); Uni-dir. mesh ball 50K/600 Ω jack plug cable adaptor, £5.28 (33p); Omni-dir. Ball mesh, 50K, cable adaptor, jack plug, £4.29 (33p each). SPEAKERS: Very popular 12" ROUND, fitted tweeter, 3, 8 or 15 ohms (state which) £2.06 (33p) or pair for stereo £4.65, charges paid. SMALL 2 1/2", 3 Ω, 8 Ω or 64 Ω (state which) 41p (9p). More speakers in List. HEADPIECES: High resistance 2000 Ω adjustable £1.10 (11p). EARPIECES: with lead and min. 2.5mm or 3.5mm (state which) jack plug. MAGNETIC 12p. CRYSTAL (3.5mm plug only) 28p (up to 6 for 9p any size). SOLDERING IRON: 81mm, modern, British high speed, 8 1/2", all parts replaceable, highest quality, fully guaranteed £1.29 (11p). TRANSFORMERS: sub-min. 11 x 11 x 12mm. OUTPUT (3 Ω for OC72, etc.) 16p or DRIVER 17p (Up to 12 for 7p). CONNECTING WIRE: Packs of 5 coils, each coil 5yds. Asste. coils. SOLID CORE 16p (8p). FLEXIBLE CORE 18p (10p). RETRACTABLE FLEXIBLE LEADS (CURLIES) with phono plug each end, or phono plug one end, phono socket at the other (state which) 6ft, 30p; 12ft, 59p (either 7p). USA. 16p). 12v/7 pin synch. (128R7) 21" ex. pins, 72p (9p any type). MAINS BATTERY ELIMINATORS: Two models, both 240v A.C. input. Suit most radios and cassette recorder/players, with front switch, pilot lights, mains and output leads Model SC. 3, 6, 7i and 9v 400mA, stabilised with multi-output adaptor £5.50 (35p), Model N.R. has additional 12v output and is 500mA £6.00 (35p).

OUR LIST (see heading) has added to the above items more Cartridge and Stylus and Valent Table, Special Non-repeatable Offers, Aerials, Diodes, Transistors, Multi-Leads, Plugs, Sockets of many types, Speakers, Vol. Controls, Multi-testers, Professional Microphones, Mike Inserts, Neons, Indicators, STEREO Headphones, Pocket Screwdrivers, Testers, Tel. Pick-ups, Wire, Cable, etc., etc.

LASKY'S 1974 CATALOGUE

FREE

Send this coupon today for your Free copy of Lasky's Famous Hi-Fi, Audio and Electronics Catalogue.

NAME

ADDRESS

.....

.....

AUDIOTRONIC HOUSE, THE HYDE, LONDON, NW9 6JJ

POST TODAY FOR FREE DETAILS

ICS

 your key to a brighter better future

To: International Correspondence Schools, Dept. 232A
Intertext House, Stewarts Road, London, SW8 4UJ.

Name

Address

Age Occupation

Accredited by the C.A.C.C.

SAXON ENTERTAINMENTS LTD.

STANDARD & CUSTOM-BUILT AUDIO & ELECTRONIC EQUIPMENT
NEW & SECONDHAND MUSICAL INSTRUMENTS.
DISTRIBUTORS FOR A.K.G. HIGH QUALITY MICROPHONES.

P/A MULTI-CHANNEL SAXON MIXER CONTROL UNITS

Using grouped pairs of inputs and outputs (high Z and low Z inputs) with individual bass, treble and volume controls on each pair, plus master control. These low-noise units will feed all makes of amplifiers, making them ideal for clubs, discos etc. Standard jack sockets. Compact design. In strong metal cases. All units guaranteed for 8 years.

- HIGH & LOW IMP. INPUTS
- BASS/TREBLE/VOLUME ON EACH PAIR
- MASTER CONTROL OUT



M.4H
4 high Z, 4 low Z inputs, 4 sets of controls. Case 14" x 8" x 2 1/2"
Carr. pd. + V.A.T. **£18-50**

M.6HL Case 18" x 8" x 2 1/2"
12 inputs (6 high Z, 6 low Z).
Carr. pd. + V.A.T. **£27-50**

● Channel section modules, for building your own mixer. Gain—16 x (24dB). Tone controls—18dB swing. Carr. pd. £3-50 + V.A.T.

SAXON CONTROL UNITS

Mono (as shown)
For 9v battery operation. As stereo unit but less mic. input

Carr. 20p

£6-50

Stereo. Carr. 30p

£15-80



Two decks, and full headphone monitoring. The unit is mains operated and measures 17 1/2" x 3" x 4" deep and is finished with a smart white on black fascia. The controls are: Left/Right deck fader, volume, bass treble, Headphone Selector and volume, Microphone volume, bass, treble, mains on/off.
COMPARABLE TO UNITS AT OVER TWICE THE PRICE.



120 WATT HEAVY DUTY MODULE

Rugged class A driver stage, this module will run from all our mixers, etc., and most other makes. Delivers 120 watts into an eight ohm load and employs 4 T03 cans (115 watt) output transistors. These are the modules where extra power is demanded.

Power output 120 watts on 8 ohms
Freq. response 20-20,000 Hz: ± 2dB
Input sensitivity 200 mV into 10K
Construction Fibreglass board
Size 8" x 4" x 4" (5" with supply)

£18-95

Low distortion parallel push-pull output stage.

Module & power supply (Carr. 40p)

160 watt version with power supply **£37-90**
£27-50 (Carr. 50p)



SOUND AND LIGHT UNITS

Our popular 3 channel model handles up to 3kW (3000 watts) of lighting and incorporates versatile sound control arrangement to enable professional standards to be achieved. Both units are excellent examples of Saxon quality and value.

3 CHANNEL UNIT

Includes bass, middle and treble as well as master controls. 2 amplifier sockets eliminate need for split leads. Up to 3KW lighting load. Smartly finished steel case. Carr. 30p.

£19-75

SINGLE CHANNEL UNIT

Operates from 5 to 100 watt amplifiers. Supplied, for bass note operation, is easily adapted for treble or mid-range at a cost of about 5p.

Carr. pd. **£8-90**

COMPLETE AMPLIFIERS

CSE 100 £34-90 carr. free

The versatile unit is now available in a black vinyl case and so represents even better value than ever delivering speech and music powers of up to 100 watts RMS and continuous signal outputs of 70 watts. Two individually controlled inputs with wide range bass and treble controls.

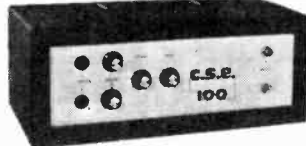

SAXON 100 £48-50 carr. free



With an RMS output of 120 watts speech and music, 100 watts continuous power, four individually controlled FET input stages and wide range bass and treble controls, this amplifier has established itself as a unit offering quality and reliability at low cost.

LOUDSPEAKERS British made bargains

12" 25 watt 8/15 ohms £5-95 carr. 30p 15" 50 watt 8/15 ohm £14-50 carr. 50p.

12" 40 watt 15,000 gauss magnet system 8/15 ohm £11-50 carr. 40p.

600 watt 3 colour Light Boxes Smart Rexine finish £15 carr. free.

A.K.G. D.190C MICROPHONES **£18-45**

A true professional mic at a bargain price.

SAE with enquiries please as well as for current price lists.

Prices quoted do NOT include V.A.T. 10% must be added on to total value of order for V.A.T. S.A.E. for special price list

Better built Better performance Better value

SAXON POWER AMP MODULES FOR DOMESTIC, P.A. AND COMMERCIAL USE

These superbly designed & engineered Saxon power amplifiers use 3A 'Mastik' Power Driver Transistors. To meet demand, we have included a more powerful module in our well-established and proven range, the SA.50. These power amplifiers are expertly assembled, tested and guaranteed. By buying direct from us, you save appreciably, and the modules offer superb value for reliability and versatility.



DESIGNED AND MADE IN OUR OWN FACTORY

SA35 35 watts RMS. Uses 7 transistors and 7 diodes Carr. paid. **£4-45**
SA50 50 watts RMS. 7 transistors, 7 diodes. Carr. paid. **£5-65**
SA100 makes an ideal unit in disco assemblies. A real platoon for work. Reliable, tough and compact, 11 transistors, 6 diodes. Carr. paid. **£10-90**

BRIEF SPEC. FOR ALL THREE MODULES

All modules incorporate OPEN AND SHORT CIRCUIT PROTECTION, plus proof against over-dissipation and faulty inductive loads in the SA.100.

Freq. response 15-40,000 Hz ± 1dB
Distortion 0.2% at 1kHz
Loads 4 to 16 ohms
Quiescent current 15 mA
Noise Better than -75dB
Supply voltage SA35 25-45 volts
SA50/SA100 40-70 volts
4 1/2" x 4" x 1" (SA.100)
4 1/2" x 3" x 1" (SA35/SA50)

Size

Circuits, connecting instruction and application data are supplied free with all modules.

ALL SAXON MODULES ARE BUILT ON GLASS FIBRE P.C. BOARD AND SUPPLIED FULLY TESTED AND GUARANTEED

SAXON POWER UNITS

PU.45 UNSTABILISED. For 1 SA.50 into 4Ω or up to 2 x SA.35 (P/P—30p) **£4.90**
PU.70 UNSTABILISED. For up to 2 x SA.50's into 8Ω or 1 or 2 SA.100s (P/P—40p) **£7.75**
PS.45 STABILISED. For up to 2 x SA.50 into 8Ω or 1 or 2 SA.100s (Carr. paid) **£3.50**
MT.45 Mains Transformer (P/P—30p) **£3.50**
PS.75 STABILISED. For 1 or 2 SA.50s into 8Ω or 1 or 2 SA.100s (Carr. paid) **£4.90**
MT.75 Mains Transformer (P/P—40p) **£4.90**

Orders and personal shoppers to:

SAXON ENTERTAINMENTS LTD., 327 Whitehorse Rd., W. Croydon, Surrey. CR0 2HS.

Telephone 01-684 6385

Hours 9.30 a.m.—5.30 p.m.

TRADE & EXPORT ENQUIRIES INVITED

TERMS OF BUSINESS

Cash with order (C.W.O.) For C.O.D. please add 35p extra, cash by regd. letter, please



GIRO NO. 331 7056
C.W.O. only. P. & P. 10p on orders below £5
Discount: £10-10%, £20-15% (except net items)
Export Order enquiries welcome (VAT free)

Official Orders accepted from
Educational & Government Departments
ALL PRICES INCLUDE VAT

SPECIAL RESISTOR KITS

10E12 1/2W KIT: 10 of each E12 value, 10 ohms—1M, a total of 610 (CARBON FILM 5%), £3.10 net
10E12 1/4W KIT: 10 of each E12 value, 10 ohms—1M, a total of 610 (CARBON FILM 5%), £3.20 net
25E12 1/2W KIT: 25 of each E12 value, 10 ohms—1M, a total of 1525 (CARBON FILM 5%), £7.20 net
25E12 1/4W KIT: 25 of each E12 value, 10 ohms—1M, a total of 1525 (CARBON FILM 5%), £7.30 net
20E12 1/2W KIT: 20 of each E12 value, 10 ohms—1M, a total of 1220 (METAL FILM 5%), £8.50 net
15E12 1/2W KIT: 15 of each E12 value, 10 ohms—1M, a total of 915 (METAL FILM 5%), £8.15 net
10E12 2W KIT: 10 of each E12 value, 10 ohms—1M, a total of 610 (METAL FILM 5%), £12.65 net

MULLARD POLYESTER CAPACITORS C280 SERIES
250V P.C. Mounting: 0.01µF, 0.015µF, 0.022µF, 0.033µF, 0.047µF, 3½p, 0.068µF, 0.1µF, 4½p, 0.15µF, 4½p, 0.22µF, 5½p, 0.33µF, 8p, 0.47µF, 9p, 0.68µF, 11p, 1µF, 15p, 1.5µF, 22p, 2.2µF, 25p

MULLARD POLYESTER CAPACITORS C296 SERIES
400V: 0.001µF, 0.0015µF, 0.0022µF, 0.0033µF, 0.0047µF, 2½p, 0.0068µF, 0.01µF, 0.015µF, 0.022µF, 3½p, 0.033µF, 4½p, 0.047µF, 0.068µF, 0.1µF, 4½p, 0.15µF, 6½p, 0.22µF, 8½p, 0.33µF, 12p, 0.47µF, 14p, 0.68µF, 18p, 1µF, 22p, 2.2µF, 25p

MINIATURE CERAMIC PLATE CAPACITORS
50V: (pF) 22, 27, 33, 39, 47, 56, 68, 82, 100, 120, 150, 180, 220, 270, 330, 390, 470, 560, 680, 820, 1K, 1K5, 2K2, 3K3, 4K7, 6K8, (µF) 0.01, 0.015, 0.022, 0.033, 0.047, 2½p, each, 0.1, 30V, 4½p, 0.1, 100V, 5½p

POLYESTER CAPACITORS 160V 5%
(pF) 10, 15, 22, 33, 47, 68, 100, 150, 220, 330, 470, 680, 1000, 1500, 2200, 3300, 4700, 4p, 6800, 10,000, 4½p

RESISTORS

CF—High Stab	Carbon Film, 5%	MF—High Stab	Metal Film, 5%	
W. Type	Range	1-9	10-49	50-99
1	CF 22-1M	1	0.8	0.65
2	CF 22-2M2	1	0.8	0.65
3	CF 22-1M	1	0.8	0.65
4	MF 10-2M7	1	0.9	0.8
5	MF 10-2M2	1	0.9	0.8
6	MF 10-10M	1.5	1.25	1.1
7	MF 10-10M	3	2.5	2
			1.75	1.6

For value mixing prices, please refer to our catalogue. (price in pence each)
VALUES AVAILABLE—E12 Series only.

PRESET SKELETON POTENTIOMETERS

MINIATURE 0.25W Vertical or horizontal 6p each 1K, 2K2, 4K7, 10K, etc. up to 1M Ω
SUB-MIN 0.05W Vertical, 100 Ω to 220K Ω 5p each

(P.W.) 61 CHEDDINGTON ROAD, PITSTONE,
NR. LEIGHTON BUZZARD, BEDS, LU7 9AQ
Tel.: Cheddington 668446 (Std. Code 0296)
PLEASE WRITE FOR FREE CATALOGUE

B. H. COMPONENT FACTORS LTD.

Miniature Mullard Electrolytics

1.0µF	63V	6p	68µF	16V	6p
1.5µF	63V	6p	100µF	63V	12p
2.2µF	63V	6p	150µF	25V	6p
3.3µF	63V	6p	100µF	63V	14p
4.7µF	63V	6p	150µF	16V	6p
6.8µF	63V	6p	150µF	63V	15p
8.0µF	40V	6p	220µF	6.4V	9p
10µF	16V	6p	220µF	10V	6p
10µF	25V	6p	220µF	16V	8p
10µF	63V	6p	220µF	63V	21p
15µF	16V	6p	330µF	16V	12p
15µF	63V	6p	330µF	63V	25p
16µF	40V	6p	470µF	6.4V	9p
22µF	25V	6p	470µF	40V	20p
22µF	63V	6p	680µF	16V	15p
32µF	10V	6p	680µF	40V	25p
33µF	16V	6p	1000µF	16V	20p
33µF	40V	6p	1000µF	25V	25p
32µF	63V	6p	1500µF	6.4V	15p
47µF	10V	6p	1500µF	16V	25p
47µF	25V	6p	2200µF	10V	25p
47µF	63V	6p	3300µF	6.4V	26p

VEROBOARD 0.1 0.15

2½ x 5"	28p	28p
2½ x 3½"	26p	19p
3½ x 5"	32p	33p
3½ x 3½"	28p	28p
2½ x 1"	7p	7p
2½ x 5" (Plain)	—	14p
2½ x 3½" (Plain)	—	12p
2½ x 3" (Plain)	—	22p
Insertion tool	59p	59p
Track Cutter	44p	44p
Pins, Pkt. 25	10p	10p

TRANSISTORS

AC127	16p	BC212L	12p
AC128	22p	BC213L	12p
BC107	11p	BC214L	12p
BC108	12p	OC44	18p
BC109	13p	OC71	13p
BC148	12p	OC81	16p
BC149	12p	OC170	23p
BC182L	12p	TIS43	33p
BC183L	12p	2N2926	11p
BC184L	13p	2N3702	11p

POTENTIOMETERS

Carbon Track 5K Ω to 2M Ω, log or lin. Single, 16½p Dual Gang 46p. Log Single with switch 26p
Slider Posts. 10K, 100K, 500K. 30mm, 34p. 45mm, 47p. 60mm, 53p.

DIODES

IN4001	5½p
IN4002	7p
IN4003	9p
IN4004	9p
IN4005	12p
IN4006	14p
IN914	7p
IN916	7p
BA100	10p
OA5	42p
OA47	9p
OA81	11p
OA200	8p

Integrated Circuits

µA709C	30p
µA741C	35p
µA723C	£1
µL914	35p

PLUGS

DIN 2 Pin	12p
3 Pin	13p
5 Pin 180°	15p
Std. Jack	14½p
2.5mm Jack	11p
Phono	8½p

SOCKETS

DIN 2 Pin	10p
3 Pin	10p
5 Pin 180°	12p
Std. Jack	14½p
2.5mm Jack	11p
Phono	5½p

ELECTROLYTIC CAPACITORS. Tubular & Large Cans

(µF/V): 2.2/25, 2.2/63, 4.7/10, 4.7/25, 4.7/63, 22/10, 22/25, 22/63, 5p, 2/10, 10/10, 50/10, 100/10, 10/25, 50/25, 10/50, 5½p, 200/10, 100/25, 50/50, 6½p, 500/10, 200/25, 100/50, 9p, 1000/10, 500/25, 200/50, 11p, 2000/10, 1000/25, 500/50, 16½p, 1000/50, 39p, 1000/100, 66p, 2000/25, 27p, 2500/12, 17p, 2500/25, 33p, 2500/50, 62p, 3000/50, 71p, 5000/25, 66p, 5000/50, 94p, 7000/50, 60p, 25,000/25, 74p. HI-VOLT: 8/350, 14p, 16/350, 19p, 32/350, 25p, 50/250, 18p, 100/500, 33p

METALLISED PAPER CAPACITORS

250V: 0.05µF, 0.1µF 4½p, 0.25µF, 5½p, 0.5µF, 6½p, 1µF, 9p, 500V: 0.025µF, 0.05µF 4½p, 0.1µF, 5½p, 0.25µF, 6½p, 0.5µF, 9p, 1000V: 0.01µF, 10p, 0.022µF, 10p, 0.047µF, 0.1µF, 16p, 0.22µF, 1µF, 0.47µF, 3½p

QUANTITY DISCOUNT

SPECIAL BULK BUY PRICES
ARE AVAILABLE BY
QUOTATION FOR LARGE
PROJECTS AND TRADE

**YOUR CAREER in
RADIO &
ELECTRONICS ?**

Big opportunities and big money await the qualified man in every field of Electronics today—both in the U.K. and throughout the world. We offer the finest home study training for all subjects in radio, television, etc., especially for the CITY & GUILDS EXAMS (Technicians' Certificates); the Grad. Brit. I.E.R. Exam.; the RADIO AMATEUR'S LICENCE; P.M.G. Certificates; the R.T.E.B. Servicing Certificates; etc. Also courses in Television; Transistors; Radar; Computers; Servo-mechanisms; Mathematics and Practical Transistor Radio course with equipment. We have OVER 20 YEARS' experience in teaching radio subjects and an unbroken record of exam. successes. We are the only privately run British home study College specialising in electronics subjects only. Full details will be gladly sent without any obligation.

To: British National Radio & Electronics School, P.O. Box 156, Jersey, C.I.

Please send FREE BROCHURE to

NAME Block
ADDRESS Caps.
..... Please
..... W.C. 123

**BRITISH NATIONAL RADIO
AND ELECTRONICS SCHOOL**

Fun With HI-FI

In this book Gilbert Davey defines exactly what high fidelity sound is. He describes the different links in the hi-fi system—the playing deck, cartridge, tuner, amplifier, loudspeaker and loudspeaker assembly—and the part each plays in the reproduction of hi-fi sound. He tells the reader what kind of equipment is available today, and concludes with the latest developments in stereo headphones and four-track stereo—'quadraphonic sound'. Fully illustrated, £1.15.

PUBLISHED BY KAYE & WARD

If you have difficulty in obtaining

**PRACTICAL
WIRELESS**

Please place a regular order with your newsagent or send 1 year's subscription (£2.65) to:—

Subscription Department,
Practical Wireless,
Tower House, Southampton Street,
London, WC2E 9QX

now...

Project 80

...exciting new thinking
in modular hi-fi design

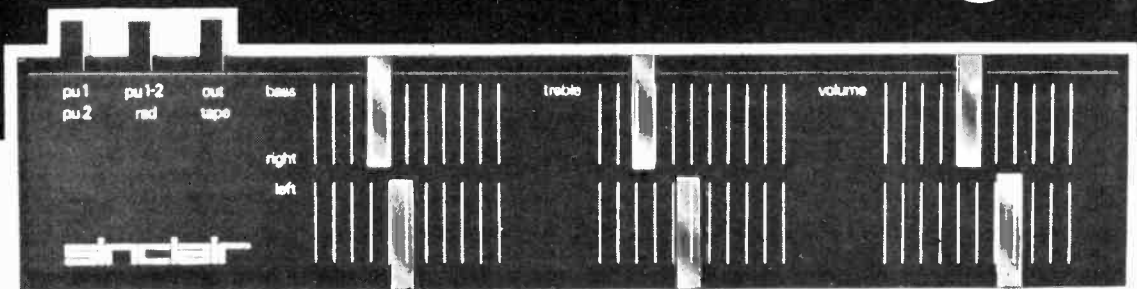

Stereo 80 pre-amplifier/control unit

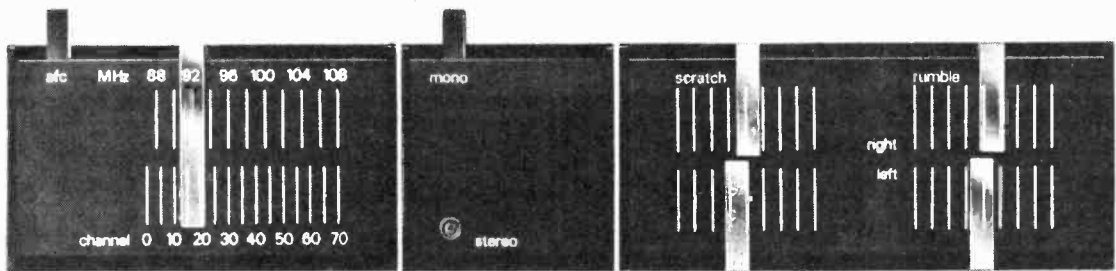

Project 80 tuner

Stereo decoder

Project 80 Active Filter Unit (AFU)

the slimmest, most elegant hi-fi modules ever made

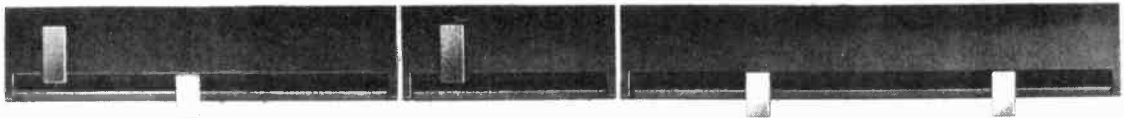

Living with hi-fi takes on new meaning now that Project 80 is here. These amazing new modules mark a brilliant technical advance all round; their size and presentation bring exciting new opportunities to install systems in ways hitherto only dreamed about but never before made practical. You can build a Project 80 system virtually anywhere and it is unbelievably simple to install and connect up. Everything that could possibly be wanted in a top quality do-it-yourself domestic hi-fi system will be found in Project 80 – compactness, elegantly ultra-modern styling, ease of fixing and operation, new control methods, and above all superb performance. New as well as popular established ideas on installation are featured on page four of this announcement to provide just a few examples of the system's fantastic versatility.

sinclair

Project 80 new modules

Stereo 80 pre-amplifier and control unit

As with other Project 80 units, the Stereo 80 is mounted by means of two bolts fixed at the rear which pass through holes drilled in the wood or plastic on which modules are to be mounted. All the electronics are contained within the $\frac{3}{4}$ " deep front panel! Connecting leads are taken away similarly out of sight. Each channel in the Stereo 80 has its own independent tone and volume controls operated by sliders. This enables exceptionally good environmental matching to be obtained. Provision is made for magnetic and ceramic pick-ups, radio and tape in and out. A virtual earth input stage forms part of the up-dated circuitry of the Stereo 80 to ensure the finest possible quality from all signal sources. Generous overload margins are allowed on all inputs. Clear instructions with template are supplied.

TECHNICAL SPECIFICATIONS

Size - 260 · 50 × 20mm (10 $\frac{1}{2}$ × 2 × $\frac{3}{4}$ ins)
 Finish - Black, with white markings
 Inputs - Mag. P. U., 3mV RIAA corrected; Ceramic P. U. 300 mV
 Radio 300 mV; Tape 30 mV
 S/N ratio - 60db
 Frequency range - 20Hz to 15KHz ± 1dB 10Hz to 25KHz ± 3dB
 Power requirements - 20 to 35 volts
 Outputs - 100mV+ AB monitoring for tape
 Controls - Press button for tape, radio and P. U. selection Volume, Bass + 12dB to - 14dB at 100Hz, Treble + 11dB to - 12dB at 10KHz

Project 80 FM tuner smaller, more efficient

A truly remarkable tuner in every way - its unbelievably compact size - its original circuitry - its dependable performance - all this in a boldly designed modern case measuring 85 × 50 × 20mm (3 $\frac{1}{2}$ × 2 × $\frac{3}{4}$ ins). Greater adaptability (and possibly financial convenience) results from the tuner and stereo decoder section being made available separately.

TECHNICAL SPECIFICATIONS

Size - 85 · 50 · 20mm (approx. 3 $\frac{1}{2}$ · 2 · $\frac{3}{4}$ ins)
 Tuning range - 87 to 108 MHz
 Detector - I. C. balanced coincidence, for good A. M. rejection
 AFC - Switchable, with thermistor control to prevent from drift
 One 26 transistor I. C.
 Twin dual varicap tuning
 Distortion - 0.3% at 1KHz for 75KHz deviation
 Ceramic filter in I. F. section
 Aerial impedance - 75 Ω or 240-300 Ω
 Sensitivity - 4 microvolts for 30dB quieting
 Power requirements - 12 to 45 volts

Project 80 stereo decoder

Making the Project 80 decoder separate from the F. M. tuner gives the constructor a wider choice of systems as well as saving money in cases where stereo reception may not be required. This unit gives a 40dB channel separation with an output of 150mV per channel. The gallium arsenide light emitting beacon automatically lights up to show when a stereo transmission is tuned in. Designed essentially as an integral part of Project 80 systems, this multiplex stereo demodulator may be used in many cases with existing single channel frequency modulated tuners to provide stereo reception.

Size - 47 · 50 · 20mm (1 $\frac{3}{4}$ · 2 · $\frac{3}{4}$ ins)
 One 19 transistor I. C.

NEW



- For P. U., radio and tape
- Tape monitoring switch
- Two-hole fixing

RRP £11.95 + £1.19 VAT

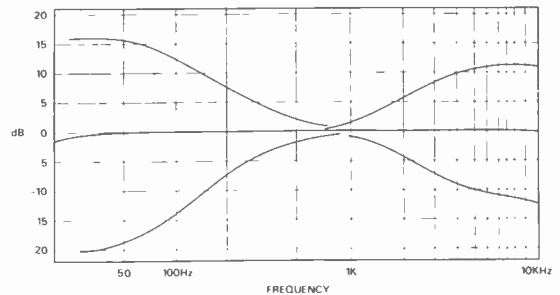

NEW

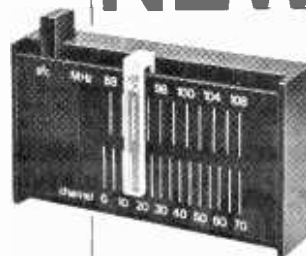

- AFC switch
- Twin dual varicap tuning
- 4-hole ceramic filter
- Slider tuning

RRP £11.95 + £1.19 VAT

NEW

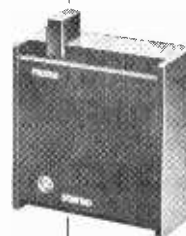

- Solid-state stereo indicating beacon
- Readily adaptable for use with other tuners

RRP £7.45 + 0.74p VAT

new constructional techniques

...and again Sinclair leads the world

- 1962 Micro-miniature power amp small enough to stand on a 10p. piece. Slimline pocket receiver smaller than a 20 cigarette pack
- 1963 Micro-6 receiver, smaller than a matchbox
- 1964 Pocket F.M. receiver, PWM amp.
- 1965 Z.12 power amplifier module; PZ.3 power supply
- 1966 Stereo 25 pre-amp/control unit
- 1967 Micromatic Q.14 loudspeaker; the first Neoteric
- 1968 IC.10, the first ever integrated circuit for constructors use

- 1969 Q.16 - improved version of Q.14 Systems 2000 and 3000: Project 60 launched
- 1970 IC.12 Project 60S
- 1971 Project 60 stereo FM tuner, Z.50 PZ.8
- 1972 Improvements to Project 60 with Z.50 MK.2 and PZ.8 Mk.3 The Executive Calculator, Digital multi-meter Q.30 speaker
- 1973 Cambridge Calculator

PROJECT 80 LAUNCHED
... and next?

Project 80 active filter unit

This efficiently designed unit makes a highly desirable part of any worthwhile system where inputs may be from record, radio or tape. As with Stereo 80, separate controls are applied to each channel thereby making it easier to obtain ideal stereo balance in any kind of indoor environment

TECHNICAL SPECIFICATIONS

Size - 108 · 50 · 20mm (4½ · 2 · ¾ins)
Voltage gain - minus 0.2dB
Frequency response - 36Hz to 22KHz, controls minimum
Distortion - at 1KHz - 0.03% using 30V supply
HF cut off (scratch) - 22KHz to 5.5KHz, 12dB/oct slope
L.F. cut off (rumble) - 28dB at 20Hz, 9dB/oct. slope



NEW

- For scratch and rumble control
- Transistorised active circuitry

R.R.P. £6.95 + 0.69p V.A.T.

Z.40 & Z.60 power amplifiers totally short-circuit proof

Either of these entirely new power amplifiers is intended for use in Project 80 installations although, of course, they are readily adaptable to an even wider range of applications. Both Z.40 and Z.60 incorporate built-in protection against shortcircuiting and risk of damage arising from mis-use is greatly reduced. Comprehensive instructions are supplied with each of the modules

Z.40 Technical Specifications

Size - 55 · 80 · 20mm
(2½ · 3½ · ¾ins) 9 transistors
Input sensitivity - 100mV
Output - 15 watts RMS continuous into 8 Ω (35V), 30 watts music power into 4 Ω (30V)
Frequency response - 10Hz - 100KHz ± 1dB
Signal to noise ratio - 64dB
Distortion - at 10 watts into 8 Ω less than 0.1%
Power requirements - 12-35 volts

Z.60 Technical Specifications

Size - 55 · 98 · 20mm
(2½ · 3½ · ¾ins) 12 transistors
Input sensitivity - 100-250mV
Output - 25 watts RMS into 8 Ω (45V), 50 watts music power into 4 Ω (50V)
Distortion - typically 0.03%
Frequency response - 10Hz to more than 200KHz ± 1dB
Signal to noise ratio - better than 70dB
Built-in protection against transient overload and short circuit
Load impedance - 4Ωmin; max. safe on open circuit

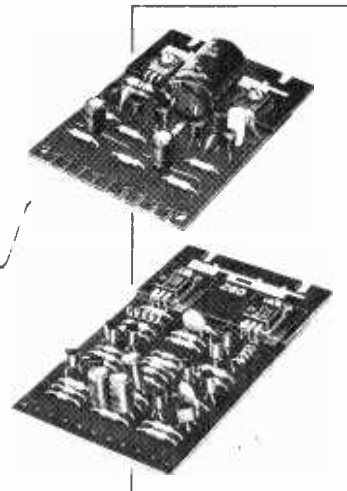

NEW

Z.40
R.R.P. £5.45 + 0.54p V.A.T.

Z.60 ✓
R.R.P. £6.95 + 0.69p V.A.T.

Sinclair power supply units PZ.8

the worlds most advanced unit in its class

Stabilised power supply unit. Re-entrant current limiting makes damage from overload or even direct shorting impossible, a principle never before incorporated in a commercially available constructor module. Normal working voltage (adjustable) 45V
R.R.P. £7.98 + 0.79p V.A.T.
Without mains transformer PZ.5 30V unstabilised
R.R.P. £4.98 + 0.49p V.A.T.
PZ.6 35V, stabilised
R.R.P. £7.98 + 0.79p V.A.T.

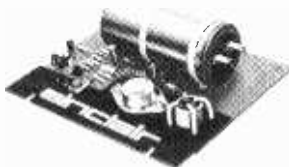

sinclair

Recommended Project 80 applications

System	The Units to use	Units cost
Simple battery record player	Z.40	£5.45 + 54p V.A.T.
Mains-powered record player	Z.40, PZ.5	£10.43 + £1.04 V.A.T.
30W. RMS continuous sine wave stereo amp	2 × Z.40s, Stereo 80; PZ.6	£30.83 + £3.08 V.A.T.
50W (8 Ω) RMS continuous sine wave de luxe stereo amplifier Indoor P.A.	2 × Z.60s, Stereo 80; PZ.8	£33.83 + £3.38 V.A.T.
Car Radio	F.M. tuner, Z.40	£16.40 + £1.64 V.A.T.

From Sinclair the worlds most advanced hi-fi modules

Sinclair Project 80 the ultra-modern non-obtrusive hi-fi

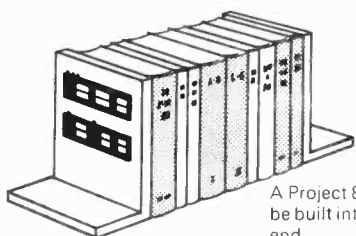

A Project 80 system could be built into a book-shelf end

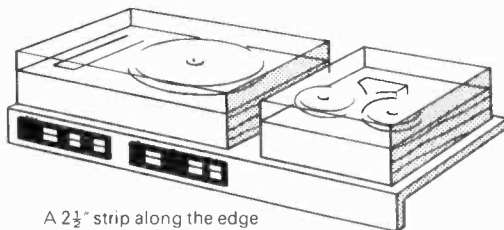

A 2½" strip along the edge a shelf could be sufficient to contain a complete system

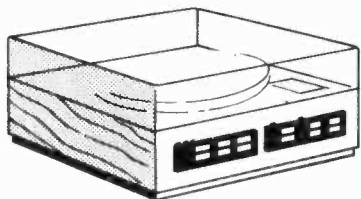

The modules mount very easily onto a playing plinth

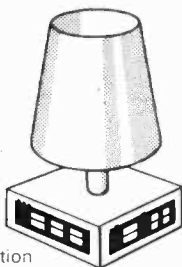

A novel application would be to build around the base of a lampshade

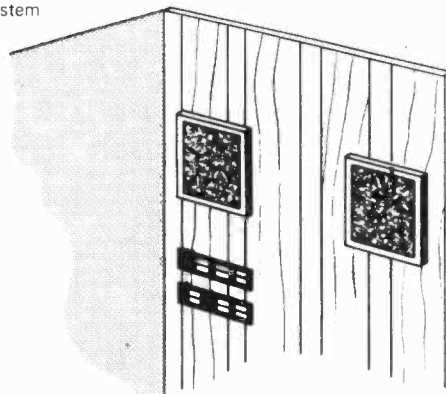

Two Sinclair Q.16 loudspeakers suitably positioned together with Project 80 could be mounted on to a false wall.

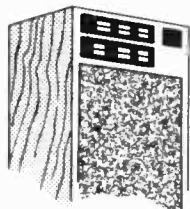

Project 80 could be easily mounted onto a loudspeaker cabinet

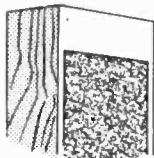

When you have seen for yourself how fantastically slim and cleverly designed these modules are, further ways will suggest themselves in which they can become a pleasing part of your particular domestic environment.

To SINCLAIR RADIONICS LTD. ST. IVES, HUNTINGDON PE17 4HJ

Please send post paid _____

for which I enclose Cash/Cheque for £ _____ including V.A.T.

Name _____

Address _____

PW 12

Guarantee

If, within 3 months of purchasing any product direct from us, you are dissatisfied with it, your money will be refunded on production of receipt of payment. Many Sinclair appointed Stockists also offer this guarantee.

Should any defect arise in normal use, we will service it without charge. For damage arising from mis-use a small charge (typically £1.00) will be made.

sinclair

Sinclair Radionics Ltd.
London Road, St. Ives,
Huntingdon PE17 4HJ
Telephone St. Ives (0480) 64311

Practical Wireless Classified Advertisements

Situations Vacant

Mobile Radio Survey Engineer

A ground floor opportunity exists for a young man to join a rapidly expanding radio-telephone Company, to assist the Southern Regional Sales force in Surveying and Demonstrating all mobile radio U.H.F./V.H.F. products

- Location:** All Southern England—based London or Home Counties.
- Experience:** An advantage but not essential as full training given.
- Salary:** Negotiable dependent on qualifications and experience.
- Prospects:** Excellent. Starting with eventual promotion to Sales Force for suitable applicant.
- We Require:** Ability to work on own. Initiative. Common sense. Clean driving licence. Reliability. Sense of responsibility. Willingness to get on with people.

If you like travelling, working out of doors and have even a slight sense of adventure, then we would like to hear from you.

Write or telephone in the first instance to:—



Mrs Dyne, Personnel Officer,
Burndep Electronics (ER) Ltd., St. Fidelis, Road,
Erith, Kent, DA8 1AU. Tel: Erith 39121

Service Sheets

SERVICE SHEETS, Radio, TV etc., 8,000 models, Catalogue 15p. S.A.E. enquiries, Telray, 11 Maudland Bank, Preston.

SERVICE SHEETS for Televisions, Radios, Transistors, Tape Recorders, Record Players, etc., from 5p with free Fault-Finding Guide. S.A.E. orders/enquiries, Catalogue 15p. Hamilton Radio, 47 Bohemia Road, St. Leonards, Sussex. Telephone Hastings 29066.

Service Sheets

LARGE SUPPLIER OF SERVICE SHEETS

(T.V., RADIO, TAPE RECORDERS, RECORD PLAYERS, TRANSISTORS, STEREOGRAMS, RADIOGRAMS, CAR RADIOS)
ALL AT 40p EACH

"PLEASE ENCLOSE LARGE S.A.E. WITH ALL ENQUIRIES & ORDERS"

Otherwise cannot be attended to
(Uncrossed P.O.'s please, original returned if service sheets not available.)

PLEASE NOTE
We operate a "by return of post" service. Any claims for non-delivery should be made within 7-days of posting your order.

C. CARANNA 71 BEAUFORT PARK LONDON, N.W.11

We have the largest supplies of Service Sheets (strictly by return of post). Please state make and model number alternative. Free TV fault tracing chart or TV list on request with order.

Mail order or phone 01-458 4882

Aerials

GENUINE FULL SIZE 18 element TV aerial as used by leading TV companies

FOR ONLY £2.20 (plus 35p cart)

ITV, BBC1 & 2, B/W & Colour Guaranteed
Perfect Pictures. Save ££s. We supply this genuine U.H.F. aerial for only £2.20. can be fitted outside or inside.
Quality made technically advanced design. Precision grid/reflector eliminates ghosting.
Complete with clamp, instructions advance. Money Back Refund.
Wall/Caravan Bracket 25p Low Loss Cable 10p per yard. Plug 8p & FREE with order maps & channel reference of all Radio & TV Transmitters.
SEND DIRECT TO DEPT. PW10
219 Mansfield Rd. Nottingham.

IMPERIAL TRADING AERIALS LTD.
the quality Aerial Specialists

BAINES HIGH FREQUENCY AERIALS
Postage paid on aerials
UHF Multibeams and Parabees
PBM 12 £3.35. PBM 18 £4.30. MBM 30 £4.40. MBM 46 £6.90. MBM 70 £12.10. Log periodic £6.00.
VHF Stereo beams
SBM 1 £2.20. SBM 2 £2.95. SBM 3 £4.40. SBM 4 £4.80. SBM 6 £7.25. Stacking kit £2.20. Rotator £23. Loft kit 44p. 75/300 Balun £1.60. Masthead VHF/UHF amplifiers £5.75 and £7.75. Setback £4. Accessories: A large s.a.e. please. Coax 4p and 8p. 11 Dale Cres., Tupton, Chesterfield S42 6DR
Tel: 863755

LADDERS 'Special Offer' Unvarnished Triples, 9ft 7in closed—24ft 7in extended £13.20 delivered. Home Sales Ladder Centre (WLS2) Haldane (North), Halesfield (1) Telford, Shropshire. Tel: 0952 586644.

Educational

GO TO SEA as a Radio Officer. Write: Principal, Nautical College, Broadwater, Fleetwood FY7 8JZ.

SERVICE SHEETS • MANUALS • BOOKS

SERVICE SHEETS 40p plus S.A.E. * SERVICE SHEET CATALOGUE 25p
OVER 12,000 SERVICE SHEETS & MANUALS IN STOCK ON COLOUR/MONO TELEVISIONS RADIOS, RADIOGRAMS, T/RECORDERS, R/PLAYERS, ETC. S.A.E. WITH ENQUIRIES

NEW BOOKS & PUBLICATIONS	PRICE
HOW TO GET THE BEST OUT OF YOUR TAPE RECORDER by P. J. Guy. 142 pp.	£1.50
CREATIVE TAPING RECORDING by Vivian Capel. 183 pp. Shows advanced techniques.	£3.50
TAPE RECORDERS by H. W. Hellyer. 239 pp. A must for the enthusiast.	£2.25
UNDERSTANDING ELECTRONIC CIRCUITS by Ian R. Sinclair. 204 pp. 127 illus.	£3.50
UNDERSTANDING ELECTRONIC COMPONENTS by Ian R. Sinclair. 218 pp. 130 illus.	£3.50
FAULT LOCATION EXERCISES in Radio & TV Servicing by K. J. Bohlman. VOL. 1.	£0.80
FAULT LOCATION EXERCISES in Radio & TV Servicing by K. J. Bohlman. VOL. 2.	£1.35
WORLD RADIO TV HANDBOOK 1972. 26th Edition. 384 pp. Special reduced offer.	£1.10
WORLD RADIO TV HANDBOOK 1973. 27th Edition. 400 pp.	£3.00
TRANSISTOR AUDIO & RADIO CIRCUITS by Mullard Ltd. 283 pp. 2nd Edition.	£1.80
POWER ENGINEERING USING THYRISTORS by Mullard Ltd. Vol. 1. 228 pp.	£1.50
RADIO TECHNICIANS BENCH MANUAL by H. W. Hellyer. 215 pp. 131 Illustrations.	£3.00
AUDIO TECHNICIANS BENCH MANUAL by John Earl. 182 pp. 114 Illustrations.	£3.00
MOBILE RADIO TELEPHONE EQUIPMENT HANDBOOK. Ccts. diagrams for PYE mods	£4.00
ELECTRONICS IN MUSIC by F. C. Judd. 169 pp. Circuit designs and operation.	£3.15
HANDBOOK OF TRANSISTOR EQUIVALENTS & SUBSTITUTES by B. B. Babani.	£0.40
HANDBOOK OF RADIO, TV, TUBE AND VALVE EQUIVALENTS by B. B. Babani.	£0.40
HI-FI, PA, GUITAR & DISCOTHEQUE AMPLIFIER DESIGN HANDBOOK by Babani.	£0.75
RADIO AMATEURS OPERATORS HANDBOOK by Data Publications Ltd. 80 pp.	£0.45
SIMPLE SHORT WAVE RECEIVERS by Data Publications Ltd. 140 pp.	£0.80
SERVICING TRANSISTOR RADIO RECEIVERS by F. R. Pettit. 3rd Edition. 88 pp.	£0.75
USING AN OSCILLOSCOPE by D. W. Easterling. 108 pp.	£0.70
SERVICING WITH THE OSCILLOSCOPE by G. J. King. 176 pp. Illustrated.	£1.80
BEGINNERS GUIDE TO RADIO by G. J. King. 7th Edition. 204 pp. Illustrated.	£1.00
RADIO VALVE AND TRANSISTOR DATA by A. M. Ball. 9th Edition. 240 pp.	£0.75
NEWNES RADIO & TELEVISION SERVING books bought & sold (all years) Good prices paid. Send large S.A.E. for FREE booklists. Postage on above books is 5p in the £1.00 (UK only).	

BELL'S TELEVISION SERVICES

ALBERT PLACE, HARROGATE, YORKSHIRE. Telephone 0423-86844

LEC

TELEVISION TRAINING

(MONOCHROME AND COLOUR)

This private College provides theoretical and practical training in Radio and TV Servicing. Courses of 16 months' duration, with daily attendance, are available for beginners and shorter courses for men with previous training in Electronics and Radio. Next course commencing Jan. 2nd. Training courses in Marine Radiocommunication and Radar are also available. Write for prospectus to: London Electronics College, Dept. A12/, 20 Penywern Road, Earls Court, London SW5 9SU. Tel. 01-373 8721.

Books and Publications

"WORLD RADIO TV HANDBOOK 1973," £2.80+11p. "Shortwave Voices of the World," £1.70, postage and VAT 11p. "SWL Address Book," to clear, £1.40+11p. "Confidential Frequency List," £1.70+11p. Books and full details from any bookshop, or in difficulty write to: David McGarva, PO Box 114, Edinburgh EH1 1HP.

Radio BOOKS

Handbk of Transistor Equip and Substitutes	45p
Handbook of Tested Transistor Circuits	45p
Rad & Electr Colour Codes and Data Chart	20p
Hi Fi PA & Disco Amplifier Design Hbk	80p
Boys BK of Crystal Sets and Simple Circuits	23p
Electronic Novelties for the Motorist	55p
Radio Servicing for Amateurs	25p
High Fidelity Loudspeaker Enclosures	45p
Practical Tape Recording Handbook	35p
Practical Stereo Handbook	35p
Practical Radio Inside Out	45p
Transistor Circuits Manual No. 1	20p
Transistor Circuits Manual No. 2	20p
Coil Design and Construction Manual	35p
Radio TV and Electronics Data Book	30p
Transit Circuits for Radio Controlled Models	45p
Pract Transistor Audio Amplifiers, Book 1	25p
Transistor Test Equip and Servicing Manual	30p
Handbook of Simple Transistor Circuits	40p
Modern Transistor Circuits for Beginners	45p
Sound and Loudspeakers Manual	55p
Resistor Colour Code Disc Calculator	15p
Manual Transistor Audio Amplifiers	45p
Practical Car Radio Handbook	35p
Radio TV and Industrial Tube & Valve Equip	45p
Transistor Circuits Manual No. 2	20p
Television Servicing Vol. 1	95p
Television Servicing Vol. 2	95p
Television Servicing Vol. 3	70p
Television Servicing Vol. 4	95p
Using an Oscilloscope	80p
Servicing Transistor Radio Receivers	85p
Television Timebase Circuits	£1.10p
Pal-D Colour Receiver Questions & Ans.	78p

All prices include postage & packing

FREE lists of other titles avail on request. Send to:

RADIO BOOK SERVICE
40 Elwill Way, Beckenham BR3 2RZ

DENCO CLACTON LIMITED

355-7-9 Old Road

Clacton-on-Sea, Essex

Catalogue 20p post paid

S.A.E. all enquiries

WORLD RADIO TV HANDBOOK 1974 (published December) £3.15. Delivered direct from Denmark if ordered now. How to Listen to the World (late October), £2.00. Postage and VAT included. Every order acknowledged immediately. David McGarva, PO Box 114, Edinburgh EH1 1HP.

For Sale

MORSE MADE EASY!!

FACT NOT FICTION. If you start RIGHT you will be reading amateur and commercial Morse within a month (normal progress to be expected).

Using scientifically prepared 3-speed records you automatically learn to recognise the code RHYTHM without translating. You can't help it, it's as easy as learning a tune. 18 W.P.M. in 4 weeks guaranteed.

Beginner's Section only £3.30. Complete Course £4.50 P.P.I. etc. plus 10%.

(Overseas £1.00 extra) details only, 4p stamp. 01-660 2896
G2HSC (Box 11), 45 GREEN LANE, PURLEY, SURREY

TV LINE OUTPUT TRANSFORMERS. Tidman Mail Order Ltd., 236 Sandycombe Rd., Richmond, Surrey TW9 2EQ. 01-948 3702.

SEEN MY CAT? 5,000 items. Mechanical & Electrical Gear, and materials. S.A.E. K. R. WHISTON, Dept. PW, NEW MILLS, Stockport.

AMIDON type toroid cores. Details SAE to T.M.P. (Electronic Supplies), Office address 3 Bryn Clyd, Leeswood, Mold, CH7 4RU.

AUDIO MIXER MODULES. Catalogue free, large S.A.E. Hillcrest Electronics, 125 Harestone Hill, Caterham, Surrey.

Wanted

TOP PRICES PAID FOR NEW VALVES and TRANSISTORS

popular T.V. and Radio types.

KENSINGTON SUPPLIES (C).

367 Kensington Street, Bradford 8, Yorkshire.

WE BUY New Valves, Transistors and clean new components, large or small quantities, all details, quotation by return. **WALTON'S.** 55 Worcester Street, Wolverhampton.

EARLY WIRELESS LITERATURE before 1934. Johnson Raffles, Haverbreaks, Lancaster. Telephone 67770 evenings.

NEWNES RADIO and TV Servicing Books wanted. From 1960-1966, £2 paid per copy by return post. Any quantity bought. Bell's Television Services, Albert Place, Harrogate, Yorks. Telephone 0423 86844.

Receivers and Components

MINI MAINS TRANSFORMERS 30x30x37mm. Cool, quiet British. Pri. 220/250V. Type MT3. 3-0-3V rms, 300mA, £1. MT7. 7-0-7V, 120mA, £1. VAT included. Use MT3 for 3V or 6V rectified d.c., MT7 for 9V or 18V. Circuits supplied. Mail order only, UK post 5p per order. Amatronix Ltd., 396 Selsdon Road, South Croydon, Surrey CR2 0DE.

TAPE HEADS

Send stamp for lists.
R.D.I. Ltd.
Chilton Works,
Garden Rd.,
Richmond,
Surrey,
TW9 4NS

For valve and transistorized recorders from £2 ea.

TRANSISTOR. 465 kc/s IF Strip 75p. Amplifier 80p. Tone Control—Pre-AMP 75p. All with circuit. Record Player Cabinets £3.50; Radio Cabinets 12in x 6in x 2 1/2. Suitable for Ext. speakers; colours blue, brown or yellow 60p. AM/FM tuning gangs 50p. Archer, 9 Pine Grove, Maidstone, Kent.

PRECISION POLYCARBONATE CAPACITORS

Close tolerance. High stability. All 63V d.c.
0.47µF: ±5% 80p; ±2% 40p; ±1% 60p
1.0µF: ±5% 40p; ±2% 60p; ±1% 80p
2.2µF: ±5% 80p; ±2% 60p; ±1% 70p
4.7µF: ±5% 70p; ±2% 80p; ±1% £1.18
6.8µF: ±5% 80p; ±2% £1.16; ±1% £1.80
10µF: ±5% £1.10; ±2% £1.40; ±1% £1.80
15µF: ±5% £1.60; ±2% £2.10; ±1% £2.70

TANTALUM BEAD CAPACITORS—Values available 0.1, 0.22, 0.47, 1.0, 2.2, 4.7, 6.8µF at 35V, 10µF 25V, 15µF 20V, 22µF 15V, 33µF 10V, 47µF 6V, 100µF 3V—all at 8p each; 6 for 45p; 14 for 95p. Special pack 6 off each value (78 capacitors) £4.50.

NEW!—TRANSISTORS. BC107, BC108, BC109, All at 9p each; 6 for 50p; 14 for £1. All brand new and marked. Full spec. details. May be mixed to qualify for quantity prices. AF178—35p each or 3 for 95p.

POPULAR DIODES. IN914, 6p each; 8 for 45p; 18 for 90p IN916, 8p each; 6 for 45p; 14 for 90p; IS44, 5p each; 11 for 50p; 24 for £1. All brand new and marked.

NEW LOW PRICE—400 mW Zeners. Values available 4.7, 5.6, 6.8, 7.5, 8.2, 9.1, 10, 11, 12, 13.5, 15V. Tol. ±5% at 5 mA. All new and marked. Price 7p each; 6 for 39p; 14 for 84p. Special offer 6 off each voltage (66 zeners) £3/65.

RESISTORS. Carbon film 5%, 1W at 40°C 1/2W at 70°C. Range from 2.2Ω to 2.2MΩ in E12 series, i.e. 10, 12, 15, 18, 22, 27, 33, 39, 47, 56, 68, 82 and their decades. High stability, low noise. All at 1p each; 8p for 10 of any one value; 70p for 100 of any one value. Special pack—10 of each value 2.2Ω to 2.2MΩ (730 resistors) £5.

440V A.C. CAPACITORS. 0.1µF, size 1 1/2in x 1in, 25p; 0.25µF, size 1 1/2in x 1in, 30p; 0.47 and 0.5µF, size 1 1/2in x 1in, 35p; 1.0µF, size 2in x 1in, 45p; 2.0µF, size 2in x 1in, 75p each.
SILICON PLASTIC RECTIFIERS 1.5 Amp Brand new wire-ended DO27. 100PIV at 8p each or 4 for 34p; 800PIV at 14p each or 4 for 50p.

7p post and packing on all orders below £5.

Please add 10% VAT to all orders.

MARCO TRADING
Dept. W12, The Maltings, Station Road
Wem, Shropshire

BRAND NEW COMPONENTS by return. Electrolytics 16V, 25V, 50V—0.47, 1, 2.2, 4.7, 10mfds.—4p, 22, 47, 42p. (50V—5p.) 100—512p. (50V—7p.) 220—6p. (50V—9p.). Subminiature bead-type tantalums 0.1/35V, 0.22/35V, 0.47/35V, 1/35V, 2.2/35V, 4.7/35V, 10/16V—8p. Mylar Film 100V—0.001, 0.002, 0.005, 0.01, 0.02—2p. 0.04, 0.05—3p. 0.068, 0.1—3 1/2p. Polystyrene 63V. E12 series 10 pf.—1,000 pf.—2p, 1,200 pf.—10,000 pf.—3p. Miniature Highstab resistors, 5%, E.12 series—Carbon Film 1/2W 10—10MΩ (10% over 1 Meg.) Metal Film 1/2W 10Ω—2.2MΩ and 1W. 27Ω—10MΩ all 3/4p each. Postage 8p. The C.R. Supply Co., 127 Chesterfield Rd., Sheffield S8.

5-N-CHANNEL FETs 3819E—£1

Full specification devices complete with data and circuit details for building voltmeter, timer, ohmmeter, etc.

Send 10p for full list of field effect transistors and other top quality transistors available at bargain prices.

REDHAWK SALES LIMITED

45 Station Road, Gerrards Cross, Bucks.
Mail Order only

COMPONENTS GALORE. Pack of 500 mixed components manufacturers surplus plus once used. Pack includes resistors, carbon and W.W., capacitors various, transistors, diodes, trimmers, potentiometers etc. Send £1+10p p&p. C.W.O. To Caledonian Components, Strathore Road, Thornton, Wiltshire

BUILD THE

TREASURE TRACER MK III Metal Locator

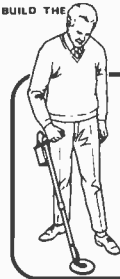

- Varcap tuning
- Excellent sensitivity and stability
- Weighs only 22oz.
- Speaker and earphone operation
- Knocks down to only 17in.
- Prebuilt search coil assembly
- Ministry approved design
- Thoroughly professional finish
- You only need soldering iron, screwdriver, pliers and snips
- Completely new design

Send s.a.e. for leaflet

Complete kit **£9-80** Built, tested and guaranteed Post 35p **£13-75**
 MINKITS ELECTRONICS, 35a LANGLEY DRIVE, WAINSTEAD, LONDON E11 2LM. (Mail order only)

Trampus electronics

ALL BRAND NEW, no rejects. Money back warranty. 5V DIGITAL INDICATOR, 0-9DIP socket and filter £1-29. LED TYPE 1" 0-9DIP £1-29. EIGHT EMITTING DIODES. All with data and panel clip. TIL 209 1" dia. 22p. Red 1" dia. type 88p. Green 76p. INFRARED beam LED £1-10. T88 GAS detector £1-89. ULTRASONIC TRANSDUCERS £2. DALO PCB resist marking pen 67p. Copper board 12" x 6" 8RBP 40p. FeC etch PAK 19p. INTEGRATED CIRCUITS: with data if required. IC LIFE SWITCH: Photo amp/mixer 40ma/11-20 relay or TTL 87p. 100 relay £1-10



IC digital clock

M08/LS1 type 24 pin 4 or 6 digit 12/24 hr. Chip with socket £18. P.C.B. £1-89. KIT £20. 741 DII 8 pin 28p. 709 14pin DII 29p. 748 29p. 710 38p. 555 TIMER mono/astable osc. clock 89p. REGULATORS: 14A 5 to 20V £1-49. 723 57p. RECEIVER ZN414 £1-09. Mini Rx kit £1-99. 1310 stereo decoder for tuners £2-69. Kit £3-35. 748 TTL: Gates 7400 etc. 15p ea. 7413 27p. 7441 75p. 7447 £1-09. 7490 59p. 7492 67p. 74121 49p. DIL SOCKETS: New type 8/14/16 pin 18p. SEMICONDUCTORS: 1A rect. 50V 31p. 400V 6p. 2N3055 32p. BC107 7p. BC108 7p. BC109 7p. BC147/8/9 10p. BC167/8/9 13p. BC177/8/9 16p. BC182/3/4 16p. BC212/3/4 11p. BC270/72 15p. BD131/2 65p. BY501/1/2 18p. T1843 UJT 24p. 2N706 11p. 2N2709 12p. 2N2926 17p. 2N2646 49p. 2N3053 17p. 2N3614 55p. 2N3702/3/4/5/6/7/8/9/10/11 All 9p. P.FETS: 2N3819E 19p. 2N3819 27p. 2N3823E 19p. TUBES: B2788 8p. 6X4 400V: 1A 89p. TRANSFORMER 1A 6/12V £1. Resistor 14p. 450 & 470 mini IF transformers—Set 3 40p. CAPACITORS: Disc 22p to 0.1 µf 3p. Electrolytic 25V: 10, 50, 100 µf 6p. 1000 µf 15p. Presets 6p. CARBON POTS 11p ea. switch 11p. Dual 89p.

FLUORESCENT LIGHTS 12VOLT £2.79

13" x 8 watt fully burnt with reflector. 13W £3.79. V.A.T. You must add 10%. (1/10) to all prices. FREE CAT. S.A.E. Data sheets. 8p ea. P. & P. 8p CWO P.O. BOX 29, BRACKNELL, BERKS.

NEW MODEL V.H.F. KIT MK2

Our latest kit. Improved design and performance plus extra amplifier stage, receives aircraft, amateurs, mobile, radio 2, 3, 4, etc., this novel little set will give you endless hours of pleasure and can be built in one evening. Powered by 9 volt battery, complete with easy to follow instruction and built in jack socket for use with earphones or amplifier.

Only £3-50 +p.p. 15p U.K. only.

Illustrated catalogue of selected kits and components, 20p inc. VAT. P&P free.

ALL PRICES PLUS 10% VAT

Galleon Trading Co.
12, Burrs Way,
Coringham,
Stanford-Le-Hope,
Essex. SS17 9DE

INTEGRATED CIRCUIT and FET modules for construction of low-cost receivers, converters, pre-selectors, etc. SAE details.—P. R. Colledge, Glen Tor, Torrington, Devon.

TUNBRIDGE WELLS, Components from Teleservice, 108 Camden Road, Tunbridge Wells, Kent. Telephone 31803.

TEXAN AMPLIFIER



Pack		£2-00 p.p. 15p
1.	P.C. Board	3-00 " 25p
2.	Chassis	1-25 " 15p
3.	Front Panel	80 " 15p
4.	Resistors	2-90 " 15p
5.	Capacitors	8-00 " 15p
6.	Semi Conductors	5-95 " 25p
7.	Transformer	2-50 " 15p
8.	Sundries	40 " 15p
9.	Cables	30 " 15p
10.	Instructions	30 " 15p
11.	100K/100K control pot	30 " 15p

VAT EXTRA

TELERADIO ELECTRONICS,
325 FORE ST., LONDON, N.9.
Tel. 01-807 3719

Send 4p for catalogue of Hi Fi Kits including the Quadrophonic System as in Practical Electronics.

MODEL CONTROL KIT. Receivers 4 channels. Transmitters 4 channels. Amplifier kits 1.5 watts mono. to 50 watt stereo. VHF kits. RF amp—mixers—oscillators. Up to 170 mhz. All kits by AMTRON. Catalogues, price lists—S.A.E. V.P. ELECTRONICS, Hayes Place, Egguckland, Plymouth PL6 5RL.

Miscellaneous

UNIQUE HI-FI SPEAKER SYSTEM

24 WATTS PEAK!

Beautiful bookshelf units in mahogany type finish. Employs infinite baffle enclosure with dual cone 8 ohm drive unit. Brand new with 6' leads.

£9-80 Per Pair P&P 60p

GREGG Electronics
PW3, 24 Cranbourn Street
Leicester Sq. London WC2

GLASS FIBRE P.C. BOARD. Large supplies available in single sided one ounce copper 2p per 3 sq. inches (under 1 foot). 75p per sq. ft. (over 1 foot). in double sided one ounce copper 1p per sq. inch (under 1 ft.), £1 per sq. ft. (over 1 foot). Please add 10p per sq. foot postage and packing. We can cut to your size at 1p per cut. Solid State Lighting, The Firs, Smallworth Lane, Garboldisham, Diss, Norfolk.

**A
L
S**

A.L.S. PRESENTS OUR E.C.100 WATT HI-FI AMPLIFIER

Ready drilled P.C.B. with full instructions only £2—plus 10p post. We also supply: Service Sheets, Manuals, Books etc. See our Main Advertisement in "TELEVISION" or send S.A.E. for details.

10 DRYDEN CHAMBERS, 119 OXFORD ST., LONDON W1R 1PA (B)

AMTRON KITS. Your Devon Stockist. E. Wenmouth, 50 South Street, Exeter 76058.

DON'T LOOK

unless you can resist the temptation to get these super 'attention-getters'!

★ Pocket-sized **MAXI-VOLT** Big 1/2 inch Spark Generator (instant 15,000 volts!). Ready-made, needs no batteries. Carry it around anywhere. Only weighs about 3 oz. (89g.) send £1-35 for your Maxi-Volt now!

★ Unique **TRANSMITTER/RECEIVER** Kit. No licence examinations or tests required to operate this transistorised equipment. Easy to build. Get transmitting. Send £5-90 for yours now!

★ Psychedelic **MINI-STROBE** Kit. Take a pocket-sized lightning storm to Disco's & parties. 'Brain-freeze' 'em with vari-speed stop-motion flashes. Includes super case too. Send £2-20 now!

(all prices include V.A.T., packing & postage.)

Send remittance to:
BOFFIN PROJECTS,
4 CUNLIFFE ROAD,
STONELEIGH, EWELL, SURREY
(Mail order only)

Or for more details, send 15p for lists plus free design project sheet.

Darned Electronic Wizardry

by Dewtron (VAT extra)

Famous kits, e.g. waa-waa complete kit £2-95. Puzzle kit £5-50 auto rhythm modules P & P 20p min. Ring Modulator modules £8 and whole range of synthesiser modules, musical novelties, etc. Catalogue 15p from D.E.W. Ltd., 254 Ringwood Road, Ferndown, Dorset.

Build your next project in a BEC (Book end chassis)



New improved with alloy trim on bottom of all cabinets. Now in easy to assemble kits.

GB3 (Illustrated) ... 14" x 9" x 4" ... £4-00 P & P 45p. Other sizes, SAE with enquiries. H. M. ELECTRONICS 275a, Fulwood Rd, Sheffield S10 3BD

STABILISED 6.75 & 9V. FROM SINGLE UNIT



AUTO ADAPTOR

In-Car Entertainment. Battery operated cassette recorders, radios etc., powered by 12v car battery by means of ingenious electronic adaptor—at virtually no cost. One lead included. Only £3-95 inc. VAT + 12p (p.p.). Also Mains Battery Eliminator £3-00. Lead (optional) 60p. State type of plug. Partic...
OMNIA PRODUCTS, 25 Wilbury Gdns., Hove, Sussex.

HARDWARE—Screws, nuts, washers and other useful items in small quantities. Sheet aluminium to individual requirements, punched/drilled. Send 6p for list. Ramar Constructor Services, 29 Shelbourne Rd. Stratford-on-Avon, Warwick.

BUILD IT in a DEWBOX quality cabinet. 2in x 2½in x any length. D.E.W. Ltd., Ringwood Road, FERN-DOWN, Dorset. S.A.E. for leaflet. Write now—Right now.

SAVE TIME SAVE TROUBLE SAVE MONEY

NEW: The COMPLETE TRANSISTOR MANUAL OF INTERNATIONAL CROSS-REFERENCES. 14 Languages. USA/Japanese/European. 56,000 Equivalents.... This YOU must own.

Price: £2.42 (Ed. Aug. 73)

- | | |
|-------------------------------|--------|
| 6 gang Socket Outlets. | £7-00 |
| 4 gang Socket Outlets. | £4-26 |
| Alarmobile (BATTERY Model) | £2-50 |
| Parking Timers (120 mins.) | £2-10 |
| Infra-Red Room Heaters 2Kw | £36-00 |
| Smith's Interval Timers | £5-39 |
| Smith's Minute Timers | £5-39 |
| Smith's Seconds Timers | £3-65 |
| Folding Lecterns | £4-10 |
| Lecterns De-Luxe (with stand) | £5-65 |

NEW: The Conway "MASTERANGER" Model 639. PROFESSIONAL Major Electronic Multi-Tester. 80 ranges, AC/DC, High Tension measurements extremely accurate and reliable. prices: From £115.00

Please send 6p for full Catalogues & Price Lists. You will also be included in our Mailing List for regular information on NEW products in our range. Full Money Back Assurance on ALL Purchases. Carriage and V.A.T. is included in all our prices.

CROWLEY & COMPANY P.O. Box 35, Walton-on-Thames, Surrey KT12 3NA.
(Reg. No: 1787003) (V.A.T. Reg. No: 212531806)

ALUMINIUM SHEET to individual sizes or in standard packs, 3p stamp for details. Ramar Constructor Services, 29 Shelbourne Road, Stratford on Avon, Warwicks.

TAPE DICTAPHONES: Grundig Stenorette, Graetz, untested/some working £4-25 postage 50p. "Markonics," 327 Tildesley Rd., London SW15.

EXPERIMENTERS! Hundreds of unusual items cheap. Catalogue 5 1/2p. Grimby Electronics, 64 Termyson Road, Cleethorpes, Lincs. (Mail Order Only).

ALUMINIUM BOXES

FOR VERPCBOARD
Type AD7 5 1/2in x 2 1/2in x 1 1/2in 29p+8p P&P
.. AD8 4 in x 4 in x 1 1/2in 29p+8p P&P
.. AD9 4 in x 2 1/2in x 1 1/2in 29p+8p P&P
.. AD10 5 1/2in x 4 in x 1 1/2in 35p+8p P&P
ALSO FULL RANGE OF 'NEWRAD' PROFESSIONAL CASES FROM UNDER £2
ADFNOC (PW), 18 Yew Tree Lane, Ashley, New Milton, Hants BH25 5BA.
C.W.O. Mail Order Only.

AERIAL BOOSTERS—£3-25

We make three types of Aerial Boosters: B45-UHF 825, B12-VHF 405, B11-VHF RADIO

VALVE BARGAINS

ANY 5-50p, 10-75p, 50-£3-30-
ECC82, ECL80, EB91, EB90, EF80, EF85, EF183, EF184, EY86, PCC84, PCC89, PCC189, PC97, PCF80, PCF86, PCF805, PCF808, PCL82, PCL83, PCL84, PCL85, PFL200, PL38, PL81, PL504, PY33, PY82, PY800, PY801, 30L15, PC86, PC88.

19" UHF/VHF (BBC2) £6-00

Thorn-850 or Pys, with sat of spare valves. Carriage £2-00 (Untested).

100 MIXED RESISTORS—85p

‡ to 2 watt—10 ohms to above 1m-ohms (our choice) 100 mixed Ceramic Capacitors from 1PF to 8200PF (our choice) 85p.

BARGAINS PARTS

Transistor UHF Tuners—£2-00, 500K-ohms V/C with Switch—20p. 50 mixed Tuner Valves—£2-25. Brand New Transistors BF173, BC171, BC153, BC135, BC113, BC117, BC115, BA102, BA129. All 10p each.

All prices include V.A.T. p. & p. 10p per order Money back guarantee. S.A.E. for leaflets.

ELECTRONIC MAILORDER (BURY) LTD.

62 Bridge St., Ramsbottom, Bury, Lancs. Tel. Rams 3036

BURGLAR AND FIRE ALARMS. Amazing new kit £23-50. Full range of kits and equipment from Castle Alarms, P.O. Box No. 6, Windsor, Berks.

CONSTRUCTION AIDS—Screws, nuts, spacers etc., in small quantities. Aluminium panels punched to spec. or plain sheet supplied. Fascia panels etched aluminium to individual requirements. Printed circuit boards—masters, negatives and boards, one-off or small numbers. Send 6p for list. Ramar Constructor Services, 29 Shelbourne Rd., Stratford on Avon, Warwicks.

H.A.C. SHORT-WAVE KITS

WORLD-WIDE RECEPTION



Famous for over 35 years for Short-Wave Equipment of quality. "H.A.C." were the Original suppliers of Short-Wave Receiver Kits for the amateur constructor. Over 10,000 satisfied customers—including Technical Colleges, Hospitals, Public Schools, R.A.F., Army, Hants, etc.

1974 "DX" RECEIVER

Complete kit—Price £4-30 (incl. p. & p. & V.A.T.). Customer writes: "Australia, India and America at loud volume—I have now heard over 300 stations including many Amateurs I have received 32 Q.S.L. verified reports—from all continents."

This kit contains all genuine short-wave components, drilled chassis, valve, accessories and full instructions. Ready to assemble, and of course, as all our products—fully guaranteed. Full range of other S.W. kits, including the famous "K plus" (illustrated above). All orders despatched by return. Send now for free descriptive catalogue of kits & components.

EXCITING "COMPETITION" for Short-Wave Listeners. Send stamped envelope for details.

"H.A.C." SHORT-WAVE PRODUCTS

29 Old Bond Street, London W.1

Versatile
10 in ONE



MIN-LAB

Comprising:

- AC and DC Voltmeter ● Audio Generator
- Ohm Meter ● Resistance Substitution
- Capacitance Substitution ● DC Ammeter
- Battery Supply ● RF Signal Generator
- RF Field Strength Indicator.

This new, unique instrument combines all you need for testing. Money back if not satisfied. **£11-95** includes VAT & p. & p. Cash with order or send s.a.e. for illustrated data sheet to:

J. H. ASSOCIATES LTD. (DEPT. PW)
Crickfield Lane, Bishop's Stortford, Herts.

SINGLE CHANNEL SOUND-TO-LIGHT CONVERTER

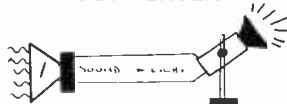

WITH LIGHT DIMMER

Max. load 2kW. at 250v. A.C.

Price includes ready built and tested module, edge connector/mounting bracket, dimmer potentiometer, audio sensitivity potentiometer, full connecting data. Price £7-90 inc. VAT

EXTRA FACILITIES. Push-button for Manual Pulsing 25p extra. Photocell for turning on the lights as the ambient light decreases, 75p extra.

3 CHANNEL FILTER UNIT

When used with three single channel modules this unit filters the sound into bass, middle and top frequencies enabling three coloured light displays to be shown. Independent sensitivity controls on each channel. Ready built and tested. Price £3-50 inc. VAT

OIL WHEEL PROJECTOR

Build your own using our



MULTI-COLOURED OIL WHEEL AND MOTOR KIT

Suitable for mounting on virtually all Slide Projectors.

Kit contains:

- ★ 6" dia. or 4" dia. OIL WHEEL (please state size required when ordering).
 - ★ Suitable Miniature mains motor.
 - ★ Full instructions.
- For Professional Discotheque use or home enjoyment. Price £7-15 inc. VAT

ELECTRONIC COMPONENTS BARGAIN COMPONENT PACKS

- Pack No.
- 1 500 Carbon resistors, 1/4, 1/2, 1, 2 watt
 - 2 100 Electrolytic Condensators
 - 3 250 Ceramic, Polystyrene, Silver Mica etc. condensers.
 - 4 250 Polyester, Polycarbonate, Paper, etc. condensers.
 - 5 250 Potentiometers, assorted
 - 6 250 High-stab, 1%, 2%, 5% resistors.
 - 7 60 Assorted Tagstrip.
 - 8 1lb wt. Assorted Nuts, bolts, washers, spacers, etc.
 - 9 250 Assorted switches, rotary, lever, micro, toggle, etc.
 - 10 50 Preset Potentiometers.

ALL COMPONENTS NEW AND UNUSED.
£1 + 25p p.p. per pack, £5 for 5 packs p/ffree

C. T. ELECTRONICS

Mail Order, Retail Shop, Components—
287 Acton Lane, LONDON, W4 5DG 01-894-6275

Warehouse, Test Equipment, Surplus Goods—
20-24 Beaumont Road, LONDON, W4

Audio Accessory Shop, Components—
17 Turnham Green Terrace, LONDON, W4

SUPERSOUND 13 HI-FI MONO AMPLIFIER



A superb solid state audio amplifier. Brand new components throughout. 5 silicon transistors plus 2 power output transistors in push-pull. Full wave rectification. Output approx. 13 watts r.m.s. into 8 ohm. Frequency response 12Hz-30KHz \pm 3db. Fully integrated pre-amplifier stage with separate Volume, Bass boost and Treble cut controls. Suitable for 8-15 ohm speakers. Input for ceramic or crystal cartridge. Sensitivity approx. 40mV for full output. Supplied ready built and tested, with knobs, cutout/hood panel, input and output plugs. Overall size 3" high x 6" wide x 7" deep. AC 200/240V. PRICE £11-60. P. & P. 40p.

DE LUXE STEREO AMPLIFIER

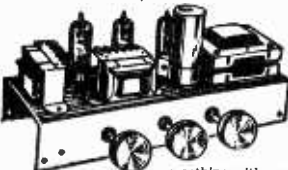

A.C. mains 200-240 v. U.S.A. plug fully insulated mains transformer with full wave rectification giving adequate smoothing with negligible hum. Valve line up: 2 x ECL86 Triode Pentodes, 1 x E280 as rectifier. Two dual potentiometers are provided for bass and treble control, giving bass and treble boost and cut. A dual volume control is used. Balance of the left and right hand channels can be adjusted by means of a separate "balance" control fitted at the rear of the chassis. Input sensitivity is approximately 300mV for full peak output of 4 watts per channel (8 watts mono) into 8 ohm speakers. Full negative feedback in a carefully calculated circuit, allows high volume levels to be used with negligible distortion. Supplied complete with knobs, chassis size 11" w x 4" d. Overall height including valves 5". Ready built & tested to a high standard. PRICE £9-90 P. & P. 50p.

POWER SUPPLY UNIT 200/240v. A.C. input. Four switched fully smoothed D.C. outputs giving 6v, and 7½v, and 9v, and 12v, at 1 amp continuous (1 amp intermittent). Fitted insulated output terminals and pilot lamp indicator. Hammer finish metal case overall size 8" x 3½" x 2½". Suitable for Transistor Radios, Tape Recorders, Amplifiers etc. etc. Ready PRICE £5-00 P. & P. 35p. built and tested.

BLACK ANODISED 16g. ALUMINIUM HEAT SINKS. For TO8, complete with mica's and bushes. Size 2½" x 3" approx. 28p pair. P. & P. 6p.

HIGH GRADE COPPER LAMINATE BOARDS 8" x 6" 5 for 55p P. and P. 23p.

BRAND NEW MULTI-RATIO MAINS TRANSFORMERS. Giving 13 alternatives. Primary: 0-210-240v. Secondary combinations 0-5-10-15-20-25-30-35-40-50v. half wave at 1 amp, or 10-0-10, 20-0-20, 30-0-30v. at 2 amps full wave. Size 3in. long x 3½in. wide x 3in. deep. Price £2-10 P. & P. 40p.

MAINS TRANSFORMER. For transistor power supplies. Pri. 200/240v. Sec. 9-0-9 at 500mA. £1-00. P. & P. 25p. Pri. 200/240v. Sec. 12-0-12 at 1 amp. £1-10. P. & P. 25p. Pri. 200/240v. Sec. 10-0-10 at 2 amp. £1-65. P. & P. 35p.

CENTRE ZERO MINIATURE MOVING COIL METER. 100µA. For balance or tuning. Approx. size 1" x 1" x 1" deep. Limited number. 85p. P. & P. 12p.

GENERAL PURPOSE HIGH STABILITY TRANSISTOR PRE-AMPLIFIER

For P.U. Tape, Mike, Guitar, etc. and suitable for use with valve or transistor equipment. 9-15v. battery or from H.T. line 200/300v. Frequency response 15Hz-25KHz. Gain 26dB. Solid encapsulation size 1½" x 1½" x 1". Brand new complete with instructions. Price: £1-00 P. & P. 15p.

HANDBOOK OF TRANSISTOR EQUIVALENTS AND SUBSTITUTES

A must for servicemen and home constructors. Including many 1000's of British, U.S.A. European and Japanese transistors. ONLY 40p. Post 5p.

3 Reference Encyclopedias for Electronic Engineers and Designers, covering between them transistor characteristics, diode and transistor equivalents. Many thousands of up to date European types listed.

Diode Equivalents	90p
Transistor Equivalents	80p
Transistor Characteristics	£1.15
POST FREE.	
All three together	£2-60

NEW ISSUE

Thyristor, Triac, Diac etc. encyclopedias. 95p. Post Free

Open 9-5.30 Monday to Friday 9-3 Saturday
Early closing Wed.

A few minutes from South Wimbledon Tube Station.

RECORD PLAYER BARGAINS
Mains models. All brand new in maker's packing. LATEST B.S.R. C108/C189 AUTOCHANGER UNITS with latest stereo/mono compatible cartridge £7-60 + 50p P. & P.
GARRARD SP25 MK III with heavy precision machined die cast turntable £10-68, carr. 55p.

PRECISION ENGINEERED PLINTHS
Beautifully constructed in heavy gauge "Colorcoat" plastic coated steel. Resonance free. Designed to take Garrard 1025, 2000, 2022TC, 2500, 3000, 3500, 5100, SP25 II and III, 8L65B, AT60 etc. or B.S.R. C109, C129, A21 etc. Black leatherette finish. Size 12½" x 14½" x 3½" high (approx. 7½" high, including rigid smoked acrylic cover). NOW ONLY £4-95. P. & P. 70p.

LATEST ACOS GP91/180 mono compatible cartridge with T/O stylus for LP/EP/78. Universal mounting bracket. £1-50 P. & P. 15p.

SONORONE STANO COMPATIBLE STEREO CARTRIDGE T/O stylus Diamond Stereo LP and Sapphire 78. ONLY £2-80 P. & P. 10p. Also available fitted with twin Diamond T/O stylus for Stereo LP. £2-80. P. & P. 15p.

LATEST RONETTE T/O STEREO/COMPATIBLE CARTRIDGE for EP/LP/Stereo/78. £1-83 P. & P. 15p. **LATEST RONETTE T/O MONO COMPATIBLE CARTRIDGE** for playing EP/LP/78 mono or stereo records on mono equipment. Only £1-50 P. & P. 15p.

QUALITY RECORD PLAYER AMPLIFIER MK II
A top quality record player amplifier employing heavy duty double wound mains transformer, ECC83, EL84, and rectifier. Separate Bass, Treble and Volume controls. Complete with output transformer matched for 8 ohm speaker. Size 7in. deep x 11in. high. Ready built and tested. PRICE £4-40. P. & P. 50p.
ALSO AVAILABLE mounted on board with output transformer and speaker. PRICE £2-85 P. & P. 60p.

SPECIAL OFFER ! HI-FI LOUDSPEAKER SYSTEMS

Beautifully made teak finish enclosure with most attractive Tygan-Vynair front. Size 16" high x 10½" wide x 8" deep. Fitted with E.M.I. Ceramic Magnet 13" x 8" base unit, two H.F. tweeter units and crossover. Maximum power handling 10 watts. Available 3 or 8 or 15 ohm impedance.

OUR PRICE £9.25 Carr. 75p

Cabinet Available Separately £4-95 Carr. 65p
Also available in 8 ohms with EMI 13" x 8" bass speaker with parasitic tweeter £7-15 Carr. 75p

HARVERSON'S SUPER MONO AMPLIFIER

A super quality gram amplifier using a double wound fully insulated mains transformer, resistor, and ECL82 triode pentode valve as audio amplifier and per output stage. Impedance 3 ohms. Output approx. 3.5 watts. Volume and tone controls. Chassis size only 7in. wide x 3in. deep x 6in. high overall. AC mains 200/240v. Supplied absolutely Brand New completely wired and tested with good quality output transformer. £3-30 P. & P. 40p BARGAIN PRICE

LOUDSPEAKER BARGAINS

5in. 3 ohm £1-05. P. & P. 17p. 7 x 4in. 3 ohm £1-15. P. & P. 20p. 10 x 6in. 3 or 15 ohm £1-90. P. & P. 30p. E.M.I. 8 x 6in. 3 ohm with high flux magnet £1-99. P. & P. 20p. E.M.I. 13½ x 8in. with high flux ceramic magnet with parasitic tweeter 3, 8 or 15 ohm £3-50. P. & P. 30p. E.M.I. 13 x 8in. 3, 8 or 15 ohm with two inbuilt tweeters and crossover network £4-85. P. & P. 30p. EMI Ceramic magnet heavy duty tweeter. Approx 3½". Available 3 or 8 or 15 ohms. £1-95 + 20p. P. & P.
BRAND NEW, 12in. 15ohm H/D Speaker, 3 or 15 ohms. Current production by well-known British maker. Now with HiLux ceramic ferrobar magnet assembly £7-50. Guitar models: 25w. £7-50 35w. £9-95. P. & P. 45p.

SPECIAL OFFER!

LIMITED NUMBER OF BRAND NEW ELAC 10" TWIN CONE LOUDSPEAKERS

With large ceramic magnet and plasticised cone surround. 8 ohm impedance. £2-70. P. & P. 85p.

Also available specification as above but size 10" x 6" £2-70 and size 8" round £2-60. P. & P. 85p.

LIMITED NUMBER EMI 2½" 8 ohm Tweeters. Mounted on flat bracket size 2½" wide x 7½" long. 70p per pair plus 15p P. & P.
Ex equipment but new and tested 70p per pair plus 15p P. & P.

12in. "RA" TWIN CONE LOUDSPEAKER. 10 watts peak handling. 3, 8 or 15 ohm £3-45. P. & P. 36p. 8½ ohm SPEAKERS. Only 70p P. & P. 25p.

"POLY PLANAR" WAFER-TYPE, WIDE RANGE ELECTRO-DYNAMIC SPEAKER
Size 11½" x 14½" x 1½" deep. Weight 19oz. Power handling 20W r.m.s. (40W peak). Impedance 8 ohm only. Response 40Hz-20kHz. Can be mounted on ceilings, walls, doors, under tables, etc., and used with or without baffle. Send S.A.E. for full details. Only £2-65 each. P. & P. 34p.

VYNAIR & BEXINSPEAKERS & CABINET FABRICS
app. 54 in. wide. Our price 85p yd. length. P. & P. 25p per yd. (min. 1 yd.). S.A.E. for samples.

HARVERSONIC SUPER SOUND 10 + 10 STEREO AMPLIFIER KIT



NEW FURTHER IMPROVED MODEL WITH HIGHER OUTPUT AND INCORPORATING HIGH QUALITY READY DRILLED PRINTED CIRCUIT BOARD WITH COMPONENT IDENTIFICATION CLEARLY MARKED FOR EVEN EASIER CONSTRUCTION

A really first-class Hi-Fi Stereo Amplifier Kit. Uses 14 transistors including Silicon Transistors in the first five stages on each channel resulting in even lower noise level with improved sensitivity. Integrated pre-amp with Bass, Treble and two Volume Controls. Suitable for use with Ceramic or Crystal cartridges. Very simple to modify to suit magnetic cartridge—instructions included. Output stage for any speakers from 5 to 15 ohms. Compact design, all parts supplied including drilled metal work, high quality ready drilled printed circuit board, smart brushed anodised aluminium front panel with matching knobs, wire, solder, nuts, bolts—no extras to buy. Simple step by step instructions enable any constructor to build an amplifier to be proud of. Brief specification: Power output: 14 watts r.m.s. per channel into 8 ohms. Frequency response \pm 3dB 12-30,000 Hz Sensitivity: better than 80mV into 1MΩ. Full power bandwidth: \pm 3dB 12-15,000 Hz. Bass boost approx. to \pm 12dB. Treble cut approx. to -16dB. Negative feedback 18dB over main amp. Power requirements 35v. at 1.0 amp. Overall Size 12" w. x 8" d. x 2½" h.

Fully detailed page construction manual and parts list free with kit and send 18p plus large S.A.E. **AMPLIFIER KIT** ... £11-55 P. & P. 25p (Magnetic input components 33p extra) **POWER PACK KIT** ... £2-30 P. & P. 35p **CABINET** ... £3-30 P. & P. 35p (Post Free if all units purchased at same time) Full after sales service.

Also available ready built and tested £23-10. Post Free.

Note: The above amplifier is suitable for feeding two mono sources into inputs (e.g. mike, radio, turn record decks, etc.) and will then provide mixing and fading facilities for medium powered Hi Fi Discotheque use, etc.



8-VALVE AUDIO AMPLIFIER HA34 MK II.

Designed for Hi-Fi reproduction of records. A.C. Mains operation. Ready built on plated heavy gauge metal chassis, size 7½" w. x 4" d. x 4½" h. Incorporates ECC83, 6L84, E280 valves. Heavy duty, double wound mains transformer and output transformer matched for 3 ohm speaker. Separate volume control and now with improved wide range tone controls giving bass and treble lift and cut. Negative feedback line. Output 4½ watts. Front panel can be detached and leads extended for remote mounting of controls. Complete with knobs, valves, etc., wired and tested for only £5-50. P. & P. 45p.

HSL "FOUR" AMPLIFIER KIT. Similar in appearance to HA34 above but employs entirely different and advanced circuitry. Complete set of parts, etc. £4-50. P. & P. 45p.

10/14 WATT HI-FI AMPLIFIER KIT

A stylishly finished monaural amplifier with an output of 14 watts from 2 EL84s in push-pull. Super reproduction of both music and speech, with negligible hum. Separate inputs for mike and gram allow records and announcements to follow each other. Fully shrouded section wound output transformer to match 3-16Ω speaker and 2 independent volume controls, and separate bass and treble controls are provided giving good lift and cut. Valve line-up 2 EL84s, ECC83, EF86 and E280 rectifier. Simple instruction booklet 15p + SAE (Free with parts). All parts sold separately. ONLY £8-80 P. & P. 60p. Also available ready built and tested £12-10 P. & P. 70p.

HI-FI STEREO HEADPHONES

Adjustable headband with comfortable flexfoam earmuffs. Wired and fitted with standard stereo jack plugs. Frequency response 80-15,000Hz. Matching impedance 8-16 ohms. Easily converted for Mono. PRICE £2-80. P. & P. 25p.

PRICES NOW INCLUDE VAT

HARVERSON SURPLUS CO. LTD.

(Dept. P.W.) 170 HIGH ST., MERTON, LONDON, S.W.19 Tel.: 01-540 3985

SEND STAMPED ADDRESSED ENVELOPE WITH ALL ENQUIRIES

(Please write clearly)

PLEASE NOTE: P. & P. CHARGES QUOTED APPLY TO U.K. ONLY. P. & P. ON OVERSEAS ORDERS CHARGED EXTRA.

WATFORD ELECTRONICS

35 CARDIFF ROAD, WATFORD, HERTS, ENGLAND

MAIL ORDER. CALLERS SATURDAYS

C.W.O. Please, P. & P. add 10p to orders under £2. Prices exclusive of VAT

PLEASE ADD 10% TO FINAL TOTAL

TRANSISTORS				DIODES				LINEAR IC's					
AC125	12p	BC147	12p	OC70	10p	OA85	7p	709C	8 pin	32p			
AC126	12p	BC148	12p	OC71	10p	OA90	5p	709C	14 pin	32p			
AC127	12p	BC149	12p	OC72	10p	OA91	5p	741C	8 pin	36p			
AC128	12p	BD131	49p	2N526	25p	OA200	8p	741C	14 pin	36p			
AC187	12p	BD132	49p	2N2928R	9p	OA202	8p	721C	14 pin	80p			
AD161	30p	BF194	15p	2N2950	9p	1N914	1p						
AD162	30p	BF195	15p	2N2925V	9p	1N4001/2	1p						
AF114	12p	BFY50	22p	2N2926G	10p	1N4003/4	7p	8 pin		23p			
AF115	12p	BFY51	22p	2N3014	10p	1N4005	7p	14 & 16 pin		15p			
AF116	12p	OC26	40p	2N3053	20p	1N4006	6p						
AF117	12p	OC28	40p	2N3055	55p	1N4007	6p						
AF118	40p	OC35	40p	2N3704	12p	1N4148	5p	BZY 88 series					
BC107	9p	OC42	10p	2N3705	9p	BZ711	18p	400mW		3-3V			
BC108	9p	OC44	10p	2N3819	22p	WO1	30p	30V					
BC109	9p	OC45	10p	TIS43	30p	WO6	34p	Price 10p each					

VEROBOARD		JACK PLUGS (CHROME)		SOCKETS	
PITCH	0 1 0 15 0-15	Standard Screened	12p	Standard	12p
	plain	Stereo Screened	30p	Stereo	15p
2 1/2 x 3 1/2"	24p 18p 12p	5mm Screened	8p	2.5mm	7p
3 1/2 x 5"	26p 20p 13p	3.5mm Screened	10p	3.5mm	7p

BIN PLUGS, SOCKETS AND COUPLERS	
Pins: 2, 3, 4, 5 (180, 240), 6, 7	
PLUGS: 12p, SOCKETS: 8p, COUPLERS: 10p	

PHONO PLUGS, SOCKETS AND COUPLERS	
Assorted Coloured Plugs: 5p, COUPLERS: 8p	
SOCKETS single: 5p, Double: 7p, Triple: 10p	

THYRISTOR		SWITCHES		CAR AERIALS	
CRS 1/60	50V 1A 20p	Toggle SPST	18p	3 Stage, Spring up,	
CRS 1/60	600V 1A 38p	DPDT	22p	keylock	£1.25
CRS 3/60	800V 3A 48p	Slide 1 amp DP	10p	Car Aerial Plugs: 10p	
CT08B	200V 4A 58p	Rotary 1-12 Way	24p		

TGS GAS SENSOR HEAD (ELECTRONIC NOSE) for detection of combustible gases with a proven record for a highly reliable Fire Detection. TGS Head can detect extremely low gas concentration levels without amplification. (PE July '73) "ELECTRONIC NOSE" illustrates amplified alarm system. TGS HEAD AND CIRCUIT APPLICATION DATA. PRICE £1.85.

ZN414 A COMPLETE RADIO IC

£1 15

A revolutionary AM/FM Receiver IC. As featured in PW Sept. '73.

RESISTORS

High Stability low noise carbon film.		Miniature wire wound		Values Available		PRICE	
Power Watts	Tol.	Range	Available	1-9	10-99	100+	
1/4	5%	2-2-10 Meg.	E12	1p	10-8p	0-7p	
1/2	5%	2-2-10 Meg.	E12	1p	0-8p	0-7p	
1	5%	2-2-10 Meg.	E12	2p	1-6p	1-4p	
4	10%	10hm-100hm	E12	8p	5p	—	

Do not mix ohmic values to obtain quantity prices. Ignore fraction.

POLYESTER CAPACITORS. Axial lead type.

400V: 0.001µF, 0.0015µF, 0.0022µF, 0.0033µF, 0.0047µF, 0.0068µF, 0.01µF, 0.015µF, 0.022µF, 0.047µF, 3p: 0.068µF, 0.1µF, 0.15µF, 4p: 0.22µF, 7p: 0.33µF, 10p: 0.47µF, 13p: 160V: 0.1µF, 0.15µF, 4p: 0.22µF, 5p: 0.33µF, 6p: 0.47µF, 7p: 0.68µF, 10p: 1µF, 13p. Radial lead P.C. type: 250V: 0.01µF, 0.015µF, 0.022µF, 3p: 0.033µF, 0.047µF, 0.068µF, 3p: 0.1µF, 4p: 0.15µF, 4p: 0.22µF, 0.33µF, 5p: 0.47µF, 7p: 0.68µF, 10p: 1.0µF, 11p.

ELECTROLYTIC CAPACITORS. Miniature axial lead type

63V: 1µF, 1.5µF, 2.2µF, 3.3µF, 4.7µF, 6.8µF, 8µF, 10µF, 15µF, 22µF, 47µF, 68µF, 6p each. 40V: 100µF, 6p; 150µF 25V, 6p; 25V: 220µF, 11p; 470µF, 13p; 1,000µF, 25p.

CERAMIC CAPACITORS: 50V d.c. Plaquette body 25mm leads.

Range: 22pF-10,000pF. Price 2p each.

POTENTIOMETERS: Carbon

Track 0-25V, log and linear values.		PRESET POTENTIOMETERS	
1kΩ-2MΩ Single gang	12p	0-25V 1kΩ-1MΩ Hor. and Vert.	6p
5KΩ-2MΩ s/gang w/switch	24p	0-1W 100Ω-220kΩ Vert. only	3p
2kΩ-2MΩ Dual gang	31p		

KNOBS
To fit 1" shaft unless specified. 8p
Black Pointer type 1p
Slim Silvered 1p
Black 1" with chrome rim 15p
Slider Pot knob 10p

WATFORD ELECTRONICS

35 Cardiff Rd., Watford, Herts, England.

Enclose 10p stamps for our comprehensive catalogue

Name

Address

INDEX TO ADVERTISERS

A. H. Supplies	774
A.S.P. Ltd.	716
Adcola Products Ltd.	723
Adfonic	805
Ambit International	735
Antex Ltd.	Cover ii
Arrow Electronics	711
B. H. Component Factors Ltd.	796
Baines, R.	802
Baker Loudspeakers Co.	778
Barrie Electronics	776
Bells Television Services	802
Bentley Acoustic Corporation	778
Bernard (Publishers) Ltd.	722
B.I.E.T.	782, Cover iii
Bi-Pak Semiconductors	718, 719
Bi-Pre-Pak Ltd.	714, 785
Boffin Projects	804
British National Radio & Electronic School	701, 736, 796
Bull, J. (Electrical) Ltd.	787
Burndept Electronics (E.R.) Ltd.	802
Bywood Electronics	768
C.T. Electronics	805
Carranna, C.	802
Chiltmead Ltd.	736
Chromasonic Electronics	780, 781
Codar	721
Colomor Electronics	794
Crowley & Co.	805
D.E.W. Ltd.	804
Dabar Electronic Products	708, 782
Denco & Co.	803
Dexter & Co.	710
Douglas Electronic Industries Ltd.	710
Dudley John Ltd.	774
Electro-Tech Components Ltd.	784
Electronic Mail Order	805
Electronic Design Associates	700
Electropares	740
Electrovalue Ltd.	739
Elekon Enterprises	782
Elvins Electronic Musical Instruments	716

Felstead Electronics	792
FlairLine	778
Francis, J. J.	715
Galleon Trading	804
Global Audio Discount Warehouse	702
Greenwell Electronics	700
Gregg Electronics	804
Group 3 Cabinets	714
HAC Short-wave Products	805
H.M. Electronics	804
Harverson Surplus Co. Ltd.	806
Heath (Gloucester) Ltd.	743
Henry's Radio Ltd.	788, 789, 790, Cover iv
Hills Components	784
Home Radio (Components) Ltd.	715
I.C.S.	792
I.L.P. Electronics Ltd.	773
Imhof Retail Ltd.	714
Imperial Trading	802
Integrex Ltd.	786
Internet Radio (Products) Ltd.	779
J. H. Associates	805
Johnson & Johnson Ltd.	774
Kaye & Ward Ltd.	796
Kensington Supplies	803
Keytronics	722
Lasky's Radio Ltd.	792
Lewis Radio	720
Linear Products Ltd.	736
London Computer Operators Training Centre	776
London Electronic College	803
Maplin Electronic Supplies	703
Marco Trading Ltd.	803
Merlin Supply Co.	720
Micro-Electronics	702
Milward, G. F.	786
Minikits Electronics	804
Morse	803
Multicore Solders Ltd.	720
Newmart Electronics	710
Omnia Products	804

Padgetts Radio Store	794
Partridge Electronics Ltd.	722
Pembridge College	778
Phononics	702
R.D.I.	803
Radio Book Services	803
Radio Component Specialists	724, 725
Radio Exchange Co. Ltd.	709
Radio & T.V. Components (Acton) Ltd.	712, 713
Radio Society of Great Britain	740, 768
Redhawk Sales	803
Ringboard	700
Riversdale Electronics Ltd.	740
RSC (Hi-Fi Centres) Ltd.	698, 699
R.S.T. Valve Mail Order Co.	801
Saxon Entertainments	795
Selray Book Co.	708
Shopertunities Ltd.	717
Sinclair Radionics Ltd.	758, 759, 798, 799, 800
Smith, A.L.	804
Smith, G. W. & Co. Ltd.	704, 705, 706, 707
Southend Electronics	782
Studio Electronics	767
Suprlectronics	708
Swanley Electronics	744
Teleradio	804
Thacker, A. H. & Sons Ltd.	794
Tidman Mail Order	803
Trade Aids	710
Trampus Electronix	804
Trannies	793
Tuac Ltd.	783
Vero Electronics	722
W.P. Components	774
Watford Electronics	807
West London Direct Supplies	768
Wilmslow Audio	744
Xeroza Radio	720
Yates Electronics	777
Young Electronics	702
Z & I Aero Services	808

FREE!

Over 150 ways to engineer a better future

HIGHER PAY

A BETTER JOB

SECURITY

find out how in just 2 minutes

That's how long it will take you to fill in the coupon. Mail it to B.I.E.T. and we'll send you full details and a free book. B.I.E.T. has successfully trained thousands of men at home - equipped them for higher pay and better, more interesting jobs. We can do as much for YOU. A low-cost B.I.E.T. home study course gets results fast - makes learning easier and something to look forward to. There are no books to buy and you can pay-as-you-learn.

Why not do the thing that really interests you? Without losing a day's pay, you could quietly turn yourself into something of an expert. Complete the coupon (or write if you prefer not to cut the page). No obligation and nobody will call on you . . . but it could be the best thing you ever did:

Others have done it, so can you

"Yesterday I received a letter from the Institution informing that my application for Associate Membership had been approved. I can honestly say that this has been the best value for money I have ever obtained - a view echoed by two colleagues who recently commenced the course".—Student D.I.B., Yorks.

"Completing your course, meant going from a job I detested to a job that I love, with unlimited prospects".—Student J.A.O. Dublin.

"My training with B.I.E.T. quickly changed my earning capacity and, in the next few years, my earnings increased fourfold!"—Student C.C.P., Bucks.

FIND OUT FOR YOURSELF

These letters - and there are many more on file at Aldermaston Court - speak of the rewards that come to the man who has given himself the specialised know-how employers seek. There's no surer way of getting ahead or of opening up new opportunities for yourself. It will cost you a stamp to find out how we can help you. Write to B.I.E.T. Dept. BPW11, Aldermaston Court, Reading RG7 4PF.

Practical Radio & Electronics Certificate course includes a learn while you build **3 transistor radio kit.**

Everything you need to know about **Radio & Electronics** maintenance and repairs for a **spare time income** and a **career** for a better future.



CUT OUT THIS COUPON

Tick or state subject of interest. Post to address below.

<input type="checkbox"/> MECHANICAL Society of Engineers—A.M.S.E. (Mech.) Institute of Engineers & Technicians (A.M.I.E.) CITY & GUILDS Gen. Mech. Eng. Maintenance Eng. Welding Gen. Diesel Eng. Sheet Metal Work Eng. Inspection Eng. Metallurgy	<input type="checkbox"/> DRAUGHTSMANSHIP Institute of Engineering Designers (A.M.I.E.D.) General Draughtsmanship Elec. Draughtsmanship Architectural Draughtsmanship Technical Drawing	<input type="checkbox"/> A.B.T. Clerk of Works Construction Surveyors Institute—L.C.S.I. CITY & GUILDS General Building (all branches) Heating & Vent. Inst. Clerk of Works Site Surveying Health Engineering Road Construction Quantities, Estimates Hydraulic Structural Eng.
<input type="checkbox"/> ELECTRICAL & ELECTRONIC Society of Engineers—A.M.S.E. (Elec.) CITY & GUILDS Gen. Electrical Engineering Electrical Installations Electrical Maths Computer Electronics Electronic Eng. Practical Radio & Electronics (with kit)	<input type="checkbox"/> RADIO & TELECOMMUNICATIONS CITY & GUILDS Radio, TV Electronics CITY & GUILDS Telecoms Gen. Radio & TV Eng. Radio Amateurs Exam Radio Servicing TV Servicing Colour TV	<input type="checkbox"/> GENERAL Agricultural Eng. Council of Eng. Institutions Farm Science Plastics
<input type="checkbox"/> MANAGEMENT & PRODUCTION Institute of Cost & Management Accnts. Computer Programming Works Mgmt. Work Study Gen. Production Eng. Estimating & Planning Storekeeping Management Skills Quality Control	<input type="checkbox"/> AUTOMOBILE & AERONAUTICAL Institute of the Motor Industry A.M.I.I. M.A.I.M.I. CITY & GUILDS Auto Eng. Gen. Auto Eng. Motor Mechanics Auto Diesel Eng. Garage Mgmt. ARB Aero Engineering Certs. Gen. Aero Eng.	<input type="checkbox"/> Supplementary courses for Nat. Certificates.
<input type="checkbox"/> CONSTRUCTION Society of Engineers—A.M.S.E. (Civ.) Institute of Building—L.I.O.B.	<input type="checkbox"/> Coaching for many exams, including C & G and assistance in ONC/HNC.	

G.C.E.
— choose from 58 'O' & 'A' level subjects.

POST TODAY FOR A BETTER TOMORROW

To B.I.E.T., Dept. BPW11 QN BPW11
Aldermaston Court, Reading RG7 4PF

NAME _____
Block Capitals Please
ADDRESS _____

OTHER SUBJECTS _____
AGE _____

Accredited by C.A.C.C.

BRITISH INSTITUTE OF ENGINEERING TECHNOLOGY

Published approximately on the 7th of each month by IPC Magazines Limited, Fleetway House, Farringdon Street, London, E.C.4. Tel: 01-534 4444. Printed in England by Index Printers, Dunstable, Beds. Sole Agents for Australia and New Zealand—Gordon and Gotch (A/asia) Ltd.; South Africa—Central News Agency Ltd.; Rhodesia and Zambia—Kingston Ltd.; East Africa—Stationery and Office Supplies Ltd. Subscription rate (including postage): For one year to any part of the world £2.50.

PRACTICAL WIRELESS is sold subject to the following conditions, namely, that it shall not, without the written consent of the Publishers first given, be lent, resold, hired out or otherwise disposed of by way of Trade at more than the recommended selling price shown on the cover, and that it shall not be lent, resold or hired out or otherwise disposed of in a mutilated condition or any unauthorised cover by way of Trade, or affixed to as part of any publication or advertising, literary or pictorial matter whatsoever.

130 LOWS

Henry's

DONT RELY ON YOUR MEMORY BUY NOW AT BARGAIN PRICES
 Order your latest Henry's Catalogue Price 55p post paid complete with Discount Vouchers



You pay less VAT with Henry's Low Prices

BUILD THE TEXAN

20 + 20 WATT IC STEREO AMPLIFIER

As featured by Practical Wireless 1972

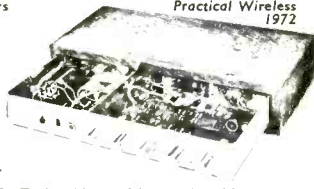

Now built and used by thousands of satisfied customers. Features slim design overall size in cabinet 15 1/4" x 2 3/4" x 6 1/2". 6-IC's, 10 transistors, stabilisers Gardners low field transformer. Fibre Glass PC Panel, complete chassis work. Now available built and tested as well as in kit form. **HIGH QUALITY & STABILITY ARE PREDOMINATE FEATURES — DEVELOPED BY TEXAS ENGINEERS FOR PERFORMANCE, RELIABILITY AND EASE OF CONSTRUCTION. FACILITIES.** On/off switch indicator, headphones socket, separate treble, bass, volume and balance controls, scratch and rumble filters, mono/stereo switch, input selector, Mag. P.U., Radio Tuner, Aux. Can be altered for Mic, Tape, Tape-head, etc. Constructional details Ref. No. 21 30p. Distributed by Henry's throughout UK. FREE—Teak cabinet with complete kit.

Kit price **£28.50** (+VAT +50p carr/packing)

or built and tested **£35.00** (+VAT + 50p carr/packing) as illustrated.

EARN YOURSELF EASY MONEY, WITH PORTABLE DISCO EQUIPMENT

- DISCO MINI A** complete portable disco, fitted mixer/preamp, 2 decks all facilities. **£98.50**
 As above but with Slider Controls **£118.50**
 100 watt amplifier for above **£42.50**
SL100 100 watt mixer/amplifier with slider controls **£69.00**
R50 50 watt mixer/amplifier **£49.50**
R100 100 watt mixer/amplifier **£57.50**
DISCO AMP 100 watt mixer/amplifier chassis unit. **£69.50**
DISCO MIXER/PREAMPLIFIERS (OP for up to 6-100 watt amplifiers)
SDL1 (rotary controls) **£49.50**
SDL11 (slider controls) **£58.50**
DISCO VOK (slider controls) the complete disco preamp **£69.50**
DJ100 100 watt power amplifier for above **£42.50**
DJ30L 3 channel 3kw sound to light **£31.50**
DJ40L as 30L plus built in microphone **£41.95**
DIMAMATIC 1 kW adjustable speed auto dimmer **£25.00**
 Carlsboro Reverberation Unit **£44.00**
SCENE STROBE £19.00. **ROAD STROBE** £25.00. **SUPER STROBE** £45.
 Disco anti-feedback microphone **£11.95**
 Coft 150 watt liquid wheel projector **£12.95**
 150 watt QL liquid wheel projector **£50.00**
 150 watt QL cassette wheel projector **£50.00**
 Spare Effects and liquid cassettes large range of patterns **£6.00**
 6 inch Liquid wheels **£5.00**
 Mini spot bank fitted 3 lamps **£12.95**
 Auto Trilite (mini with flashers) **£17.00**
 Bubblemaster with 1 gall. liquid **£41.15**
 Mixers/Mics/Speakers/Lighting
 U.K.'s largest range of Disco Lighting. **FREE STOCK LIST REF. No. 18 ON REQUEST.**
AKG / RESLO / DJ / CARLSBORO / EAGLE MICS., STANDS, MIXERS, CABINETS, CHASSIS AND COMPLETE SPEAKER SYSTEMS, MEGAPHONES, TURN-TABLES, PUBLIC ADDRESS COM-PONENTS.

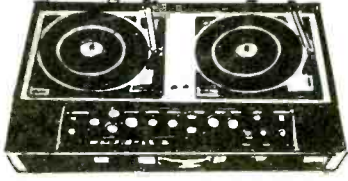

All prices carr. paid (UK) (VAT EXTRA)
 Barclaycard/Access call, write or phone your order 01-723-6963—easy terms for callers.

TEXAN STEREO SYSTEM PLUS PRICE SAVINGS



The Texan Stereo Systems include the high quality Texan Stereo amplifier assembled and ready to use. A pair of Type 200 20 watt Speaker-Tweeter systems size 21" x 12" x 10" and a choice of Garrard players built into a plinth with cover with Goldring G800 magnetic cartridge. System 25 uses Garrard SP25 Mk III and system 76 the Garrard AP76 de luxe turntable. All necessary leads are supplied.

System 25 (list approx. £109) **£79.50**
System 76 (list approx. £117) **£89.50**
 (plus 10% VAT and plus £1.45 carr/packing)

Barclaycard/Access, call, write or phone, your order 01 402 4736
EASY TERMS FOR CALLERS

NEW SINCLAIR PROJECT 80

- Stereo Pre-Amplifier **£11.95**
 Audio Filter Unit **£6.95**
 Z40 15 Watt Amplifier **£5.45**
 Z60 25 Watt Amplifier **£6.95**
 PZ5 Mod. for 1 on 2 Z40 **£4.98**
 PZ6 Mod. (S Tab) 1 on 2 Z40 **£7.98**
 PZ8 Mod. (S Tab) 1 on 2 Z60 **£7.98**
 TRANSFORMER FOR PZ8 **£2.95**

NEW FM TUNER STEREO DECODER **£11.95**
£7.45

All items post paid. Best price on request.

BUILD THE NEW HENELEC STEREO FM TUNER

A completely new high stability stereo FM tuner Features variable capacity diode tuning, stabiliser power supply, IC Decoder, high gain low noise. IF stages. LED indicators. Tuning meter, AFC, easy to construct and use. Mains operated. Slim modern design with fibre glass PC, teak cabinet, etc. Available as a kit to build or ready built. Overall size 8" x 2 1/4" x 6 1/2". Produced to give high performance with a realistic price. (Parts list and constructional details Ref. No. 5 30p). Henry's are sole distributors UK and Europe.



KIT PRICE £21.00 (+ VAT)
 or built and tested **£24.95 (+ VAT)**

LIVING SOUND LOW NOISE TOP QUALITY CASSETTES MADE BY EMI TAPES LTD. TO INTERNATIONAL STANDARDS ESPECIALLY FOR HENRY'S.
 ALL POST PAID LESS THAN 1/4 REC. PRICES COMPLETE WITH LIBRARY CASES

	3 for	6 for	10 for	25 for
C 60	£1.00	£1.80	£2.80	£6.75
C 90	£1.33	£2.57	£4.20	£10.25
C 120	£1.62	£3.15	£5.00	£12.25



Quantity and trade enquiries, invited
 LEARN A LANGUAGE—complete with phrase book. German — French — Spanish — Italian £1.36 per course. £5 for any 4.

LOW COST HI-FI SPEAKERS

SPECIAL OFFERS
 EMI 13" x 8" full range speakers (post 20p each or 30p pair)
 *150TC—8 ohms Twin Cone 10 watt £2.20 each or £4.00 pair.
 *450 10 watt C/o Twin Tweeters 3, 8 or 15 ohms £3.50 each or £6.90 pair.
 EW 15 watt 8 ohms C/o Tweeter £4.30 each or £7.90 pair.
 350 20 watt C/o Tweeters 8 or 15 ohms £7.50 each or £14.20 pair.
 * Polished wood cabinet £4.60 post 35p.



8 ohms full range (post 20p)			
FR4	4"	5 watt	£4.00
FR65	6 1/2"	10 watt	£5.50
FR8	8"	15 watt	£7.60
FR23	9 x 6"	15 watt	£6.00
BASS & MID RANGE—8 ohms (post 20p)			
AA12	5"	15 watt	£3.20
B110	5 1/2"	15 watt	£5.60
B200	8"	15 watt	£6.45
B139/2	13" x 8"	30 watt LF	£10.25
TWEETERS AND CROSSOVERS (post 20p)			
K2006	8 or 15 ohms		£1.90
FHT6	15 watt	8 ohms	£3.20
K2011	30 watt	8 ohms	£3.75
T27	KEF		£4.25
Axcent 100	30 watt	8 ohms	£4.90
K4009	1kH/5kH/5kH C/o		£2.00
SN75	3kH var. C/o		£1.75
SPEAKER KITS (carr. etc. 35p)			
20-2	8"	30 watt	£10.00 each
20-3	8"	40 watt	£15.00 each
LINTON 2		20 watt	£15.95 pair
GLENDAL 3		30 watt	£28.95 pair
DOVEDALE 3		50 watt	£42.00 pair
KEF KK2			£20.40 each
KEF KK3			£32.00 each

BUILD YOURSELF A POCKET CALCULATOR

A complete kit, packaged in a polystyrene container and taking about 3 hours to assemble, that's the Sinclair Cambridge pocket calculator from Henry's. Some of the many features include interface chip, thick-film resistor pack, printed circuit board, electronic components pack. Size 4 1/2" long x 2" wide x 1 1/2" deep. Free of charge with the kit for the more advanced technologist is a 32-page booklet explaining how to calculate Logs. Tangents. Sines etc.



£24.95 Also available assembled ready to use. **£27.22** + VAT.

10% VAT to be added to all orders. Prices and descriptions correct at time of press. E & OE. Like a permanent job at Henry's? Experienced and trainee salesmen required. Tel. 01-402 8791. See pages 788—790 of this magazine

Henry's RADIO LIMITED

EDGWARE ROAD, W2

404-406 Electronic Components and Equipment 01-402 838
 354-356 High Fidelity and Tape Equipment 01-402 5854/4736
 309 PA-Disco-Lighting High Power Sound 01-723 6963
 303 Specialist offers and bargains store
 All mail to 303 Edgware Road, London W2 1BW

Open: 9 am-6 pm 6 days a week All stores open all day Saturday