

A PUSH-PULL GRAMOPHONE AMPLIFIER

PRACTICAL 13

DECEMBER
1957

EDITOR: F.J. CAMM

WIRELESS

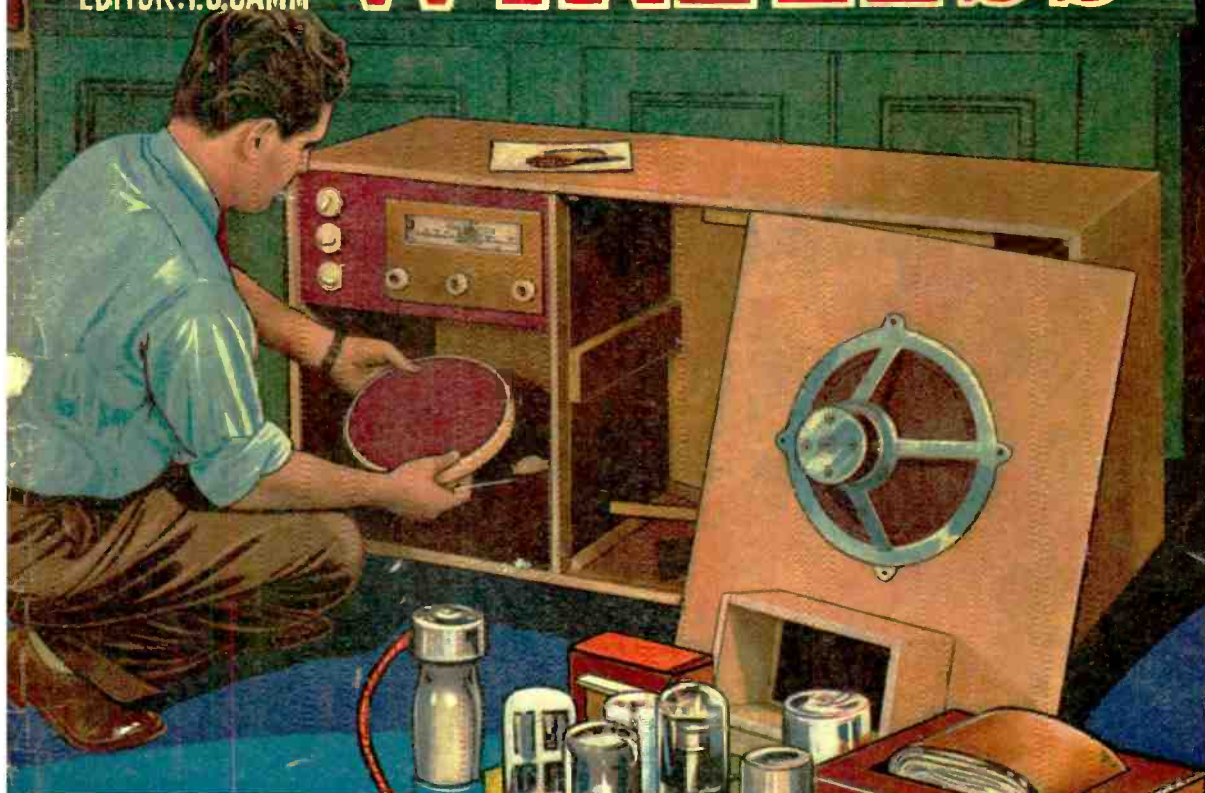

CONTENTS

MICROPHONES
TRANSISTORS
IN PRACTICE

APPLICATIONS OF THE OCP71

TRANSISTORISED PULSE GENERATOR

A COIL AND TRANSFORMER WINDING
MACHINE

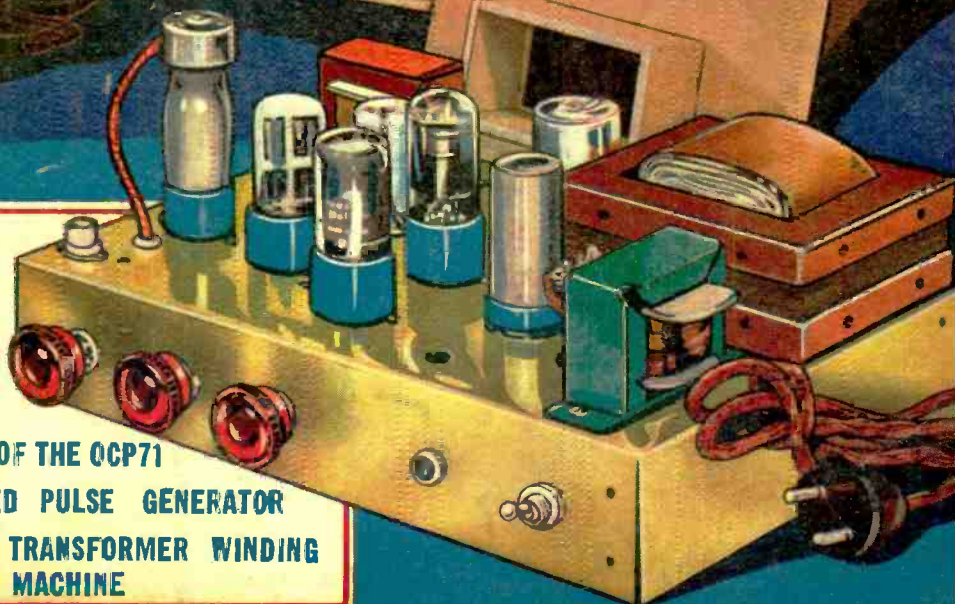

Supreme in Service

'MICROMITE'

DRY ELECTROLYTIC CONDENSERS

These small but high quality electrolytics have proved so popular that the range has been greatly extended. The use of high-gain etched foil electrodes keeps size and weight down, making the condensers suitable for suspension wiring. Conservatively rated; long shelf life ensured; green plastic insulating sleeving prevents short-circuits.



Capacity in μ F.	Peak Wkg. Volts	Surge Volts	Dimns. in Ins.		Type No.	List Price Each
			Length	Diam.		
50	12	15	1 $\frac{1}{8}$	$\frac{3}{16}$	CE87B	2/9
25	50	60	1 $\frac{1}{8}$	$\frac{3}{16}$	CE88DE	3/-
1	350	400	1 $\frac{1}{8}$	$\frac{3}{16}$	CE86L	2/6
8	350	400	1 $\frac{1}{8}$	$\frac{3}{16}$	CE99LE	3/3
16	350	400	2 $\frac{1}{16}$	$\frac{3}{16}$	CE91LE	4/-
32	350	400	2 $\frac{1}{16}$	$\frac{3}{16}$	CE90LE	6/-
4	450	550	1 $\frac{1}{8}$	$\frac{3}{16}$	CE99PE	3/3
8	450	550	1 $\frac{1}{8}$	$\frac{3}{16}$	CE90PE	3/6
16	450	550	1 $\frac{1}{8}$	$\frac{3}{16}$	CE92PE	5/-
32	450	550	2	$\frac{3}{16}$	CE94PE	7/6



THE TELEGRAPH CONDENSER CO. LTD

RADIO DIVISION : NORTH ACTON · LONDON · W.3 · Telephone : ACOrn 0061

WITHOUT DOUBT—THE FINEST VALUE IN HIGH FIDELITY!



Stentorian

MODEL H.F.1012

● *The speaker with the unique specification*

10" Die-cast unit, incorporating 12,000 gauss magnet. Fitted with the patented cambric cone and universal impedance speech coil providing instantaneous matching at 3, 7.5 and 15 ohms. Handling capacity, 10 watts. Frequency response, 30 c.p.s.-14,000 c.p.s.

Bass resonance, 35 c.p.s. **£4.19.9**
including P.T.

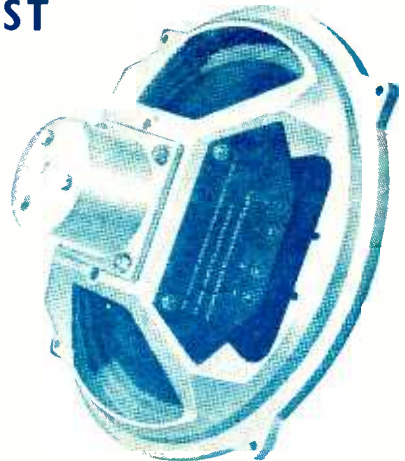

Stentorian High Fidelity Units are regularly specified by the leading designers where the maximum performance in relation to price is required. The range of speakers available is from 2½" to 15". Write for illustrated leaflets, or see and hear all Stentorian products at our London Office, 109 Kingsway, any Saturday between 9 a.m. and 12 noon.

WHITELEY ELECTRICAL RADIO CO. LTD · MANSFIELD · NOTTS

NEW! THE PRACTICAL WAY

of learning **RADIO · TELEVISION · ELECTRONICS**
AMATEUR S.W. RADIO · MECHANICS · PHOTOGRAPHY · CARPENTRY, Etc., Etc.

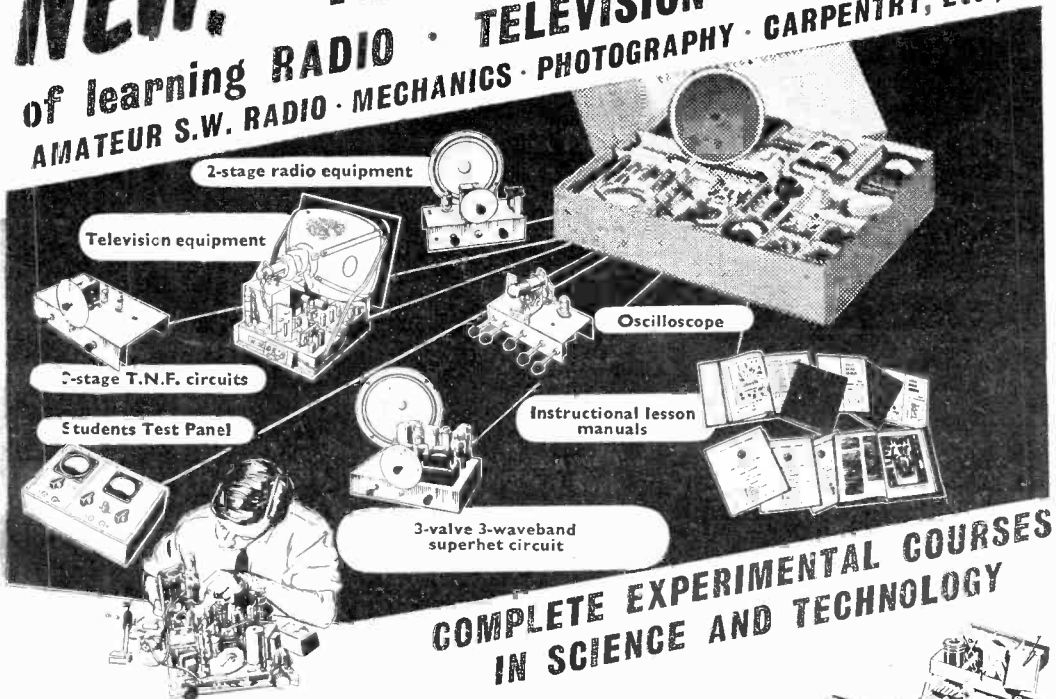

COMPLETE EXPERIMENTAL COURSES IN SCIENCE AND TECHNOLOGY

NEW... Completely up-to-date method of giving instruction in a wide range of technical subjects specially designed and arranged for self-study at home under the skilled guidance of our teachers.

NEW... Experimental outfits and lesson manuals sent on enrolment remain the student's property. Tutor allotted to each student for personal and individual tuition throughout the course. Radio and television courses, with which specially prepared components are supplied, teach the basic electronic circuits (amplifiers, oscillators, detectors, etc.) and lead, by easy stages, to the complete design and servicing of modern radio and T.V. receivers. If you are studying for an examination, wanting a new hobby, commencing a career in industry or running your own part-time business, these practical courses are ideal and may be yours for moderate cost. Fill in the coupon to-day for a free Brochure. There is no obligation whatsoever.

The only Home Study
College run by
a world-wide
Industrial
organisation



E.M.I.
Factories
at Hayes,
England

EMI INSTITUTES

- Part of "His Masters Voice," Marconiphone, etc., etc.

**SUBJECTS
INCLUDE:-**

- RADIO · SHORT WAVE RADIO**
- TELEVISION · MECHANICS · CHEMISTRY**
- PHOTOGRAPHY · ELECTRICITY · CARPENTRY**
- ELECTRICAL WIRING · DRAUGHTSMANSHIP**
- ART, ETC.**

**COURSES FROM
15/- PER MONTH**

FILL IN COUPON
FOR
FREE
PROSPECTUS



E.M.I. INSTITUTES, DEPT. 32X,
LONDON, W.4

NAME _____ AGE _____) BLOCK
 ADDRESS _____ (If under 21)) CAPS
 PLEASE

I am interested in the following subject(s) with without equip-
ment

DEC. 57 (We shall not worry you with personal visits)

IC.85

R.S.C. BATTERY CHARGING EQUIPMENT

ASSEMBLED CHARGERS

- 6 v. 1 amp. 19 9
- 6 v. or 12 v. 1 amp. 27 9
- 6 v. 2 amps. 29 9
- 6 v. or 12 v. 2 amps. 38 9
- 6 v. or 12 v. 4 amps. 59 9
- Above ready for use. Carr. 3/6. With mains and output leads.

SELENIUM RECTIFIERS

- 6-12 v. 1 a. 4 1/2 I.L.T. Types H.W. 22 9
- 6-12 v. 2 a. 8 9
- 6-12 v. 1 a. H.W. 29 9
- 6-12 v. 3 a. 11 9
- I.L.T. Types H.W. 3 9
- 6-12 v. 4 a. 14 9
- 250 v. 50 mA. 5 9
- 6-12 v. 6 a. 19 9
- 250 v. 10 mA. 7 9
- 6-12 v. 10 a. 25 9
- 250 v. 150 mA. 9 9
- 6-12 v. 15 a. 35 9
- 250 v. 30 mA. 11 9

BATTERY CHARGER KITS

- Consisting of Mains Transformer, F.W. Bridge, Metal Rectifier, well ventilated steel case, Fuses, Fuse-holders, Grommets, panels and circuit. Carr. 2/9 extra.
- 6 v. or 12 v. 1 amp. 22 9
- 6 v. 2 amps. 25 9
- 6 v. or 12 v. 4 amps. 31 9
- 6 v. or 12 v. 4 amps. 33 9

ASSEMBLED CHARGER

- 6 v. or 12 v. 2 amps. 47/9
- Fitted Ammeter and selector plug for 6 v. or 12 v. Louvered metal case, finished attractive blue hammer finish. Ready for use. With mains and output leads. Double Fused. Only Carr. 3/9.

All for A.C. Mains 200-250 v., 50 c.c.s. Guaranteed 12 months.

Assembled 6 v. or 12 v. 4 amps.



Fitted Ammeter and variable charge rate selector. Also selector plug for 6 v. or 12 v. charging. Louvered steel case with stoved blue hammer finish. Fused and ready for use with mains and output leads. Carr. 3/9. **75/-**

R.S.C. MAINS TRANSFORMERS (GUARANTEED)

Interleaved and Impregnated. Primary 200-230-250 v. 50 c.c.s. Screened.

TOP SHROUDED DROP THROUGH

- 250-0-250 v. 70 mA. 6.3 v. 2 a. 5 v. 2 a. 16 9
- 350-0-350 v. 80 mA. 6.3 v. 2 a. 5 v. 2 a. 18 9
- 250-0-250 v. 100 mA. 6.3 v. 4 a. 5 v. 3 a. 22 9
- 300-0-300 v. 100 mA. 6.3 v. 4 a. 5 v. 3 a. 22 9
- 350-0-350 v. 100 mA. 6.3 v. 4 a. 5 v. 3 a. 22 9
- 350-0-350 v. 100 mA. 6.3 v. 4 v. 4 a. C.T. 23 9
- 0-4-5 v. 3 a. 23 9
- 350-0-350 v. 150 mA. 6.3 v. 4 a. 5 v. 3 a. 29 9

FULLY SHROUDED UPRIGHT

- 250-0-250 v. 60 mA. 6.3 v. 2 a. 5 v. 2 a. Midget type 21-34in. 17 6
- 250-0-250 v. 100 mA. 6.3 v. 4 a. 5 v. 3 a. 26 9
- 250-0-250 v. 100 mA. 6.3 v. 6 a. 5 v. 3 a. for R1355 conversion 31 9
- 300-0-300 v. 100 mA. 6.3 v. 4 a. 5 v. 3 a. 26 9
- 350-0-350 v. 100 mA. 6.3 v. 4 a. 5 v. 3 a. 26 9
- 300-0-300 v. 150 mA. 6.3 v. 4 a. 6.3 v. 1 a. for Mullard 510 Amplifier 35 9
- 350-0-350 v. 150 mA. 6.3 v. 4 a. 5 v. 3 a. 33 9
- 350-0-350 v. 150 mA. 6.3 v. 2 a. 6.3 v. 2 a. 5 v. 3 a. 35 9
- 425-0-425 v. 200 mA. 6.3 v. 4 a. C.T. or Williamson Amplifier, etc. 49 9

FILAMENT TRANSFORMERS

- All with 200-250 v. 50 c.c.s. primaries 6.3 v. 1.5 a. 5 9; 6.3 v. 2 a. 7 6; 0-4-6.3 v. 2 a. 7 9; 12 v. 1 a. 7 11; 6.3 v. 3 a. 8 11; 6.3 v. 6 a. 17 6; 12 v. 3 a. or 24 v. 1.5 a. 17 6.

H.T. ELIMINATOR AND TRICKLE CHARGER KIT. Input 200-250 v. A.C. Output 120 v. 40 mA. Fully smoothed and rectified supply to charge 2 v. accumulators. Price with louvered metal case and circuit, 29 6, or ready for use, 8 9 extra.

ELIMINATOR TRANSFORMERS

- Primarys 200-250 v. 50 c.c.s. 15 9
- 120 v. 40 mA. 5-0-5 v. 1 a. 15 9
- 90 v. 15 mA. 4-0-4 v. 500 mA. 9 9

CHARGER TRANSFORMERS

- All with 200-230-250 v. 50 c.c.s. Primarys: 0-9-15 v. 1 a. 11 9; 0-9-15 v. 3 a. 16 9; 0-3-5-9-17 v. 3 a. 17 9; 0-9-15 v. 5 a. 19 9; 0-9-15 v. 6 a. 23 9.

SMOOTHING CHOKES

- 250 mA. 5 H 100 ohms 12 9
- 150 mA. 7-10 H 250 ohms 11 9
- 100 mA. 10 H 200 ohms 8 9
- 80 mA. 10 H 350 ohms 5 9
- 60 mA. 10 H 400 ohms 4 11

OUTPUT TRANSFORMERS

- Midget Battery Pentode 681 for 384, etc. 3 9
- Small Pentode 5,000 Ω to 3 Ω 3 9
- Small Pentode 7,000 Ω to 3 Ω 3 9
- Standard Pentode 5,000 Ω to 3 Ω 4 9
- Standard Pentode 7,000 Ω to 3 Ω 4 9
- 10,000 Ω to 3 Ω 4 9
- Push-Pull 10-12 watts 6V6 to 3Ω or 15Ω 15 9
- Push-Pull 10-12 watts to match 6V6 to 3-5-8 or 15 Ω 16 9
- Push-Pull 6L84 to 3 or 15 Ω 16 9
- Push-Pull 15-18 watts, 6L6, KT66 22 9
- Push-Pull 20 watts, sectionally wound 6L6, KT66, etc., to 3 or 15 Ω 47 9

MAINS TRANSFORMERS

Manufacturers' surplus, Primarys 200-250 v. 50 c.c.s. 250-0-250 v. 70 mA. 6.3 v. 2.5 a. Drop through type, 11 9. 375-0-375 v. 150 mA. 6.3 v. 4 a. C.T. 6.3 v. 1 a. Fully shrouded, 22 9. Postage 2/9 on either type.

SPECIAL OFFERS: Electrolytes, 32-32-32 mfd. 250 v. Doubler small can, 2 9 ea. 150 mfd. 450 v., 3 9. Small .0005 mfd. 2-rang. 4 9 ea. Westinghouse Rectifiers 250 v. 250 mA. 7 9. **CO-AXIAL CABLE.** 75 ohm, 1/2 in. 80 v.d. Twin-Screened Feeder 11/4, 2d.

EX-GOV'T. SMOOTHING CHOKES

- 300 mA. 20 H 200 ohms 19 9
- 250 mA. 5 H 50 ohms 12 9
- 150 mA. 10 H 100 ohms 11 9
- 150 mA. 6-10 H 150 ohms Trop. 6 9
- 120 mA. 12 H 100 ohms 9 9
- 100 mA. 5 H 100 ohms 3 11
- 80 mA. 10 H 150 ohms 3 11

EX-GOV'T. E.I.T. SMOOTHING CONDENSERS

- .02 mfd. 5,000 v. Cans. 2 9; .1 mfd. 2,500 v. Bakelite Tubulars. 3 3.

THE SKYFOUR T.R.F. RECEIVER.

A design of a 3-valve Long and Medium wave 250-250 v. A.C. Mains receiver with selenium rectifier. It consists of a variable Mu high-gain H.F. stage followed by a low distortion anode bend detector. Power pentode output is used. Valve line-up being 6K7, SP61, 6V6C. Selectivity and quality are well up to standard, and simplicity of construction is a special feature. Point-to-point wiring diagrams, instructions and parts lists. 1 9. This receiver can be built for a maximum of 24 19 6, including attractive Brown or Cream Bakelite or Walnut veneered wood cabinet 12 x 8 1/2 x 5 1/2 in.

EX-GOV'T. DOUBLE WOUND STEP UP STEP DOWN TRANSFORMERS.

- 10-0-100-200-240 v. to 5-0-75-115-135 v. or REVERSE. 80-100 watts. Only 11 9, plus 2 9 post. 10-0-100-200-240 v. to 0-0-10-122-135-148 v. or REVERSE. 200 watts. 35 9, plus 7 9 carr. Both 50 c.p.s.

EX-GOV'T. MAINS TRANSFORMER

Primary 0-110-120-200-210-220-230-240-260 v. 50 c.p.s. Secs. 275-0-275 v. 100 mA. 6.3 v. 7a. 5 v. 3 a. Govt. rating, 18 9. Following with 230-250 v. primaries. 400-0-400 v. 200 mA. 5 v. 3 a. 5 v. 2 a. 19 9. 200-0-230 v. 100 mA. 12 6 v. 1.5 a. 5 v. 2 a. 11 9. 12 6 v. 3 a. 5 v. 3 a. 9 9. Postage 2 9 on any type.

EX-GOV'T. CASES.

Size 14-10-8 1/2 in. High. Well ventilated, black crack finish, undrilled cover. IDEAL FOR BATTERY, CHARGER OR INSTRUMENT CASE, OR GOWER COULDR BE USED FOR AMP LITER. Only 9 9, plus 2 9 postage. Size 8 1/2 x 13 1/2 x 6 1/2 ins. with undrilled well ventilated cover, finished in stoved grey enamel. Suitable for charger or instrument case, 7 9, plus 2 9 post.

EX-GOV'T. VALVES (NEW)

- | | | | | | |
|--------|-----|--------|------|------|------|
| 174 | 7 9 | EF89 | 5 9 | EF80 | 7 9 |
| 185 | 7 9 | 6V6G | 7 9 | EB91 | 4 9 |
| 354 | 8 9 | 6X4 | 6 9 | EF36 | 4 9 |
| 574G | 8 9 | 6X2GT | 8 9 | EL32 | 3 9 |
| 574G | 8 9 | 6L6GT | 11 9 | EL32 | 3 9 |
| 524G | 9 9 | 807 | 7 9 | EL91 | 5 9 |
| 6K7C | 5 9 | 12A6 | 7 9 | KT44 | 8 9 |
| 68J7GT | 6 9 | 1572 | 4 9 | EZ90 | 6 9 |
| 68L1GT | 8 9 | 35Z1GT | 7 9 | EL14 | 10 6 |
| 68N7GT | 6 9 | MH4 | 4 9 | SP61 | 2 9 |
| 6AT6 | 7 9 | ECC83 | 9 9 | SP61 | 2 9 |
| 6D6 | 4 9 | ECC81 | 4 9 | 35Z1 | 8 9 |

FILM TROLYTICS (current production)

NOT EX-GOV'T.

- | Tubular Types | | Can Types | |
|----------------------|-----|--------------------------|------|
| 8uF 450 v. | 1 9 | 16 mfd. 350 v. | 1 11 |
| 8uF 500 v. | 2 6 | 16 mfd. 500 v. | 2 9 |
| 16uF 350 v. | 2 9 | 16uF 450 v. | 2 9 |
| 16uF 450 v. | 2 9 | 32uF 350 v. | 2 11 |
| 16uF 500 v. | 3 9 | 32 mfd. 450 v. | 4 9 |
| 32uF 350 v. | 3 9 | 100 mfd. 450 v. | 4 9 |
| 25uF 25 v. | 1 3 | 8-16uF 450 v. | 2 9 |
| 50uF 12 v. | 1 3 | 8-16uF 500 v. | 3 11 |
| 50 mfd 25 v. | 6 6 | 16-16uF 450 v. | 4 11 |
| 50uF 50 v. | 1 9 | 32-32uF 350 v. | 4 9 |
| 100 mfd. 12 v. | 1 9 | 32-32uF 450 v. | 5 9 |
| 100 mfd. 25 v. | 2 3 | 100-100 mfd. 350 v. | 4 9 |
| 1,500 mfd. 6 v. | 1 6 | 64-120 mfd. 350 v. | 7 9 |
| 3,000 mfd. 6 v. | 3 9 | 100-200 mfd. | 8 9 |
| 6,000 mfd. 6 v. | 5 9 | 275 v. | 6/9 |
- Many others in stock.

R.S.C. BATTERY TO MAINS CONVERSION UNITS

Type BM1. All-dry battery eliminator. Size 5 1/2 x 4 1/2 x 2 1/2 in. approx. Completely replaces batteries supplying 1.4 v. and 10 v. where A.C. mains 200-250 v. 50 c.c.s. is available. Suitable for all battery portable receivers requiring 1.4 v. and 90 v. This includes latest low consumption types.



Type BM2. Size 8 x 5 1/2 x 2 1/2 in. Supplies 120 v. 50 v. and 60 v., 40 mA. and 2 v. 0.4 ca to 1 amp. Fully smoothed. They are completely replacing both H.T. batteries and I.L.T. 2 v. accumulators. When connected to A.C. mains supply 200-250 v. 50 c.c.s. SUITABLE FOR ALL BATTERY RECEIVER

Complete kit with diagrams. 39 9, or ready to use, 46 9.

VALVES normally using 2 v. accumulator. Complete kit of parts with diagrams and instructions, 49 9, or ready for use, 59 6

JUNCTION TRANSISTORS.

Red Spot Audio Type only 7 6 each. R.F. Type 17 6.

VOLUME CONTROLS

with long (1/2 in. diam.) spindle, all values less switch, 2 9; with S.P. switch, 3 9; with D.P. switch, 4 6.

MINIATURE MOTORS.

21 28 v. D.C. or A.C. made by Hoover Ltd., Canada. Size only 2 1/2 x 1 1/2 in. Spindle 1/2 in. long. 1/2 in. diam. Brand New. 9 9.

HEADPHONES.

Brand new. Low resistance, 7 9 pr. High Resistance, 15 9 pr.

EXTENSION SPEAKERS

Ready for use in walnut veneered cabinet. 3in. 2-3 ohms. 35 9. Very limited number.



EX-GOV'T. METAL BLOCK (PAPER) CONDENSERS

- 4 mfd. 350 v., 2 9; 4 mfd. 1,000 v., 4 9; 8 mfd. 500 v., 4 9; 10 mfd. 500 v., 3 9.

R.S.C. A8 ULTRA LINEAR 12 WATT AMPLIFIER

High-Fidelity Push-Pull Amplifier with "Built-in" Tone Control. Pre-amplifier stages, high sensitivity. Includes 3 valves, 807 outputs. High Quality sectionally wound output transformer, specially designed for Ultra Linear operation, and reliable small condensers of current manufacture. INDIVIDUAL CONTROLS FOR BASS AND TREBLE "Lit" and "Cut." Frequency response 3db. 30-30,000 c.c.s. Six negative feedback loops. Hum level 71 db. down. ONLY 70 millivolts INPUT required for FULL OUTPUT. Suitable for use with all makes and types of pick-ups and practically all microphones. Comparable with the very best designs. For STANDARD or LONG-PLAYING RECORDS. For MUSICAL INSTRUMENTS such as STRING BASS, GUITARS, etc. OUTPUT SOCKET with plug provides 300 v. 20 mA and 6.3 v. 1.5 a. For supply of a RADIO FEEDER KIT. Size approx. 12 1/2" x 10 1/2" x 4 1/2". For A.C. mains 200-250 v. 50 c.c.s. Outputs for 3 and 15 ohm speakers. Kit is complete to last nut. Chassis is fully punched. Full instructions and point-to-point wiring diagrams supplied. Unapproachable value at £7 15/- or factory built 45/- extra. Carriage 10/-.

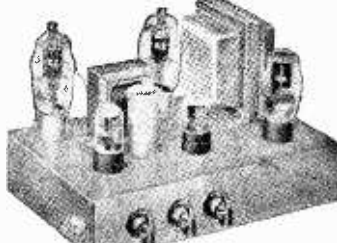

£7-15-0

It required louvred metal cover with 2 COLLAR RC54 3-SPEED AUTO-CHANGERS with Studio Pick-up Brand new. For 110 v. 50 c.p.s. A.C. mains. Price with 110 v. 200-250 v. Auto Trans. only 7 Gns. Carr. 5/6.

COLLAR RC457 4-SPEED AUTO-CHANGERS with high fidelity Studio Pick-up. Latest model. Brand new. Cartoned. For 200-250 v. 50 c.p.s. A.C. mains. Our price £8 19/6. Carr. 5/6. Credit Terms. Deposit 32 gns. and 6 monthly payments of 21/6 or with another credit purchase same deposit and 9 monthly payments 14/6.

LEG MINATURE 2-3 WATT GRAM AMPLIFIER. For use with above or any other single or auto-change units. Output for 2-3 ohm speaker. For 200-250 v. 50 c.p.s. A.C. mains. Overall size 6 1/2 x 4 1/2 x 2 1/2". Controls: Vol. and Tone with switch. Guaranteed 12 months. Only 49/9.

PORTABLE CABINETS. Exceptionally attractive appearance. Size 11 1/2 x 17 1/2 x 8 1/2 in. Will take above amplifier and any modern 3 or 4 speed auto-changer or single player. 59/6. Carr. 4/6.

SUPERHET FEEDER UNIT. Design of a high quality Radio Tuner Unit, specially suitable for use with any of our Amplifiers. Delayed A.V.C. employed. The W.Ch. Sw. Incorporates Gram position. Controls are Tuning, W.Ch. and Vol. Only 250 v. 15 mA. H.T. and L.T. of 6.3 v. 1 amp. required from amplifier. Size of unit approx. 8-6-7 in. high. Simple alignment procedure. Point-to-point wiring diagrams, instruction and priced parts list with illustration. 2/6. Total building cost, £4 15/-. For descriptive leaflet send S.A.E.

LINEAR 14.5 MINATURE 4.5 WATT QUALITY AMPLIFIER. Suitable for use with Collar, B.S.R. or any other record-playing unit, and most microph. mas. Negative feedback 12 db. Separate Bass and Treble Controls. For A.C. mains input of 200-250 v. 50 c.c.s. Output for 2-3 ohm speaker. Three miniature Mullard valves used. Size of unit only 6-5-5 1/2 in. high. Output for 2-3 ohm speaker. Guaranteed for 12 months. Only £5 19/6. Send S.A.E. for illustrated leaflet. Credit Terms. Deposit 22/6 and 5 monthly payments of 22/6.

LINEAR DIATONIC 10 WATT HIGH FIDELITY PUSH-PULL ULTRA LINEAR AMPLIFIER. For 200-250 v. 50 c.c.s. A.C. mains. Valve line-up ECC83, ECC81, E181, E221 miniature Mullard. The unit has self-contained Pre-amplifier Tone Control stages and separate Bass and Treble Controls. Independent "Mike" and Gram input sockets are provided. Size is only 9-7-6 in. Output Mains for 3 and 15 ohm speakers. Only 12 GNS. or Deposit 26/9 plus 10/- carr. and 9 monthly payments of 26/9. Send S.A.E. for leaflet.

carrying handles can be supplied for 18/9. Additional input socket with associate Vol. control so that two different inputs such as Gram and "Mike" or Tape and Radio can be mixed, can be provided for 13/- extra. Guaranteed 12 months.

TERMS on assembled two input model: DEPOSIT 25/6 and nine monthly payments 23/4. HIGH-FIDELITY MICROPHONES and SPEAKERS in stock. Keep cash prices or H.P. terms if supplied with amplifier.

R.S.C. 4-5 WATT A5 HIGH-GAIN AMPLIFIER

A highly-sensitive 4-valve quality amplifier for the home, small club, etc. Only 50 millivolts input is required for full output so that it is suitable for use with the latest high-fidelity pick-up in addition to all other types of pick-ups and practically all "mikes". Separate Bass and Treble Controls are provided. These give full long-playing record equalisation. Hum level is negligible being 71 db. down. 15 db. of negative feedback is used. H.T. of 300 v., 25 mA. and L.T. of 6.3 v. 1.5 a. is available for the supply of a Radio Feeder Unit, or Tape Deck pre-amplifier. For A.C. mains input of 200-250 v. 50 c.c.s. Output for 2-3 ohm speaker. Chassis is not alive. Kit is complete in every detail and includes fully punched chassis (with baseplate) with Blue hammer finish and point-to-point wiring diagrams and instructions. Exceptional value at only £4 15/-, or assembled ready for use 25/- extra, plus 3/6 carr. or Deposit 22/6 and 5 monthly payments of 22/6 for assembled unit.



B.S.C. TA1 HIGH QUALITY TAPE DECK AMPLIFIER. For Tape Decks with High or Low Impedance. Ready for dance, Playback and Erase Use. ONLY Heads, such as Lane, Traxov, Aspden, Collar, Brenell etc. For A.C. Mains 200-250 v. 50 c.c.s. Carriage 7/6. Positive compensated identification for recording level by Magic Eye. Recording facilities for 15, 7 1/2 or 3 1/2 in. per sec. Automatic equalisation at the turn of a knob. Linear frequency response of 3 db. 50-11,000 c.c.s. Negative feedback equalisation. Minimum microphony and hum. High output with completely effective erasure and distortionless reproduction. Sensitivity is 15 millivolts so that any kind of crystal microphone is suitable. Only 2 millivolts output required from Recording head. Provision is made for feeding a P.A. amplifier. Illustrated leaflet 6d. Special price can be quoted for Amplifier and a Deck. When ordering please state make of Deck to be used. Terms: C.W.O. or C.O.D. NO C.O.D. under £1. All goods supplied subject to terms and guarantee as detailed in current catalogue. Open 9 to 5.30 Sats. until 1 p.m. Catalogue 6d.

11 GNS.

R.S.C. 30 WATT ULTRA LINEAR HIGH-FIDELITY AMPLIFIER A10

A highly sensitive Push-Pull high output unit with self-contained Pre-amplifier Tone Control Stages. Certified performance figures compare equally with most expensive amplifiers available. Hum level 70 db. down. Frequency response 3 db. 30-30,000 c.c.s. A specially designed sectionally wound ultra linear output transformer is used with 807 output valves. All components are chosen for reliability. Six valves are used. EF86, EF86, ECC83, 807, 807, GZ33. Separate Bass and Treble Controls are provided. Minimum input required for full output is only 12 millivolts so that ANY KIND OF MICROPHONE OR PICK-UP IS SUITABLE. The unit is designed for CLUBS, SCHOOLS, THEATRES, DANCE HALLS or OUTDOOR FUNCTIONS, etc. For use with Electronic ORGAN, GUITAR, STRING BASS, etc. For standard or long-playing records, OUTPUT SOCKET PROVIDES L.T. and H.T. for a RADIO FEEDER UNIT. An extra input with associated vol. control is provided so that two separate inputs such as Gram and "Mike" can be mixed. Amplifier operates on 200-250 v. 50 c.c.s. A.C. Mains and has outputs for 3 and 15 ohm speakers. Complete kit of parts with fully punched ONLY wiring diagrams and instructions. If required cover as for A8 can be supplied for 18/9. The Carr. 10/- amplifier can be supplied, factory built with 12 months guarantee for £12 19/6. TERMS: DEPOSIT 35/9 and 9 monthly payments of 28/11.

10 GNS.

R.C.A. 20 WATT RE-ENTRANT SPEAKERS, 15 ohms or 600 ohms matching. For Outdoor work. Only 8 GNS. P.M. SPEAKERS. All 2-3 ohms, 6in. Goodmans, 17/9. 6in. Goodmans, 17/9. 8in. Rola, 19/9. 10in. Goodmans, 27/9. 10 x 6in. Elliptical Goodmans, 27/9. 12in. Plessey, 29/11. 10in. W.B. Stereorian 3 or 15 ohms type HF1012 10 watts, hi-fidelity type. Recommended for use with our A8 Amplifier. £4 10/9. 12in. Plessey 3 ohms 10 watts. (12,000 lines). 59/6.

PLESSEY DUAL CONCENTRIC 12in. 15 ohm HIGH FIDELITY SPEAKER with built-in tweeter (completely separate elliptical speaker with choke, condensers, etc.), providing extraordinarily realistic reproduction when used with our A8 or similar amplifier. Rated 10 watts. Price complete, only £5 17/6.

M.E. SPEAKERS 2-3 ohms, 8in. R.A. Field, 600 ohms, 11/9. P.M. SPEAKERS, 2-3 ohms. Suitable for use with L45, A5 or A7 amplifiers. Elac 7 x 4in. elliptical, 19/9. Celestion 6in. with high flux density magnet, 19/9. 12in. Plessey, 29/11.

R.S.C. 3-4 WATT A7 HIGH-GAIN AMPLIFIER

For 200-250 v. 50 c.c.s. Mains input. Appearance and Specification with exception of output wattage, as A5. Complete Kit with diagrams, £3 15/- Assembled 22/6 extra. Carr. 3/6.

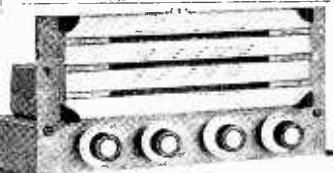

AM/FM RADIOGRAM CHASSIS. HIGH QUALITY 6-8 WATT PUSH-PULL OUTPUT

For 200-250 v. Mains. Long wave, Medium, F.M. and Gram. Complete with 9 B.V.A. valves. Guaranteed 12 months. Only 22 GNS. Or Deposit £2 12/- and 9 monthly payments of £2 12/- Post 1/9 extra under 22; £2 9 extra under 25. Complete as detailed in current catalogue. Trade List 5d. S.A.E. with all enquiries.

(LEDS) LTD.

RADIO SUPPLY CO. 32, THE CALLS, LEEDS, 2

COMMAND RECEIVERS

1.5-3 mc/s fully valved. Brand New only 65/-, p. & p. 3/6.

No. 38 TRANSMITTER RECEIVER WALKIE TALKIE. Range approx. 5 miles. Covering 7.4-9 mc/s. Absolutely complete, with junction box, headphones, microphones, webbing, haversack. Brand New only 60/-, carr. 7/6.
62A INDICATOR UNIT. Complete with VCR97 with mu-metal screen. 12 EF50, 4 SP61, 3 EA50, 2 EB34. Plus pots., switches, H.V. Cond., Resistors, Double deck chassis and crystal. Complete, as new, 70/-, carr. 7/6.

ORIGINAL AR88 MAINS TRANSFORMERS. Input 110 v.—240 v. Output 345-0-345 at 150 mA. 5 v. at 2 amps. and 6.4 v. at 4.5 amps. Fully shrouded. Size 5 1/2 in. x 4 in. x 4 1/2 in. Brand new, 50/-, p.p. 3/-.

BENDIX RECEIVER MN 26.C. Covering 150-1,500 Kc/s in 3 bands. Valves used : 5 6K7, 2 6N7, 2 6J5, 1 6F6, 1 6L7. Complete with switching motor and dynamotor. This superb unit has been modified for 12 v. operation. Only 80/-, carr. 8/6.

INDICATOR UNIT SLC NO. 5. Ideal for conversion into an Oscilloscope using a 139A or ARC 10 tube. Unit consists of 2 VR65, 1 VR66, various resistors, condensers and pots. Size 11 in. x 6 in. x 3 in. Brand new, complete with modification circuit, 20/-, p.p. 4/-.

HIGH RESISTANCE HEADPHONES.—Type Mk. IV 4,000 ohms, brand new, 11/- each, p.p. 2/-.

RI09 RECEIVERS. 8 valves 5 APR12's, 3 AR8's covering 1.8-8.5 mc/s on two frequency bands. Contains 6 v. Vibrator Pack and built-in 3 1/2 in. Goodman speaker, operates from 6v. battery, consumption 1 1/2 amps. Housed in metal case 13 x 12 x 11 in. Designed for Mobile or Ground station. Operates with any normal aerial. Complete and tested, including circuit. Very good condition. Only 80/-, Carriage 7/6.

VIBRATOR PACK.—6 v. input, 230 v. output at 100 mA., complete 4 pin vibrator, OZ4 rectifier. Fully smoothed, 25/6 each, p.p. 2/6.

WIRELESS SET No. 19, Mk. II. Two transmitter-receivers and an intercom. amplifier in one case. 'A' set covers 2-8 mc/s. R.T. and C.W. 'B' set 240 mc/s. R.T. only. Complete with 15 valves, and 500 microamp check and tuning meter. Only 70/-, plus 10/- carr.

AMERICAN ROTARY CONVERTER.—With detachable cooling fan 12 v. input, 250 v. output at 90 mA. Completely suppressed, 19/-, p.p. 4/-.

WESTINGHOUSE PENCIL RECTIFIER.—Type J.50. Output 500 v. at 5 mA. 5/- post paid.
R.F. UNITS.—R.F. 25, 40-50 mc/s, 8/6 each. R.F.26, 50-65 mc/s, 25/- each. All valved. Postage 3/6 on each.

Relda Radio Ltd.

(Dept. "P") 32A, Coptic Street, London, W.C.I. Phone : MUSeum 9607.

Let I.C.S. Train YOU!

• **COURSES ON :—**

RADIO and TELEVISION SERVICING · ELECTRONICS

• **EXAMINATION COURSES FOR :—**

P.M.G.'s CERTIFICATE (Marine Radio Operators)

C. & G. RADIO AMATEURS' EXAM.

(Amateurs' Transmitting Licence)

C. & G. RADIO SERVICING CERTIFICATE (RTEB)

BRITISH INSTITUTE OF RADIO ENGRS., etc.

Whether you plan to have your own business, to become an electronics engineer or to take up a career in industry, an I.C.S. Course will help you to success. You learn at home in your own time, under expert tuition. Moderate fees include all books.

• **LEARN - AS - YOU - BUILD**

Practical Radio Course

A basic course in radio, electronic and electrical theory backed by thorough practical training. You build a T.R.F. and a 5-valve superhet radio receiver, signal generator and multi-tester.

Other Learn-as-you-Build radio courses are available

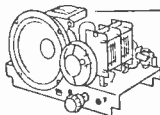

5-VALVE SUPERHET RECEIVER

MULTI-TESTER

(sensitivity 1,000 ohms per volt)



RF/AF SIGNAL GENERATOR

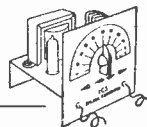

• **POST THIS COUPON TODAY** for FREE book on careers in Radio, etc., and full details of I.C.S. Courses.

INTERNATIONAL CORRESPONDENCE SCHOOLS

Dept. 170H, International Buildings, Kingsway, London, W.C.2.

Name..... Age.....
(Block Letters please)

Address.....

Occupation..... 12.57

INTERNATIONAL CORRESPONDENCE SCHOOLS

THE "WEYRAD" SIGNAL GENERATOR

AN INSTRUMENT OF HIGH ACCURACY AT LOW COST

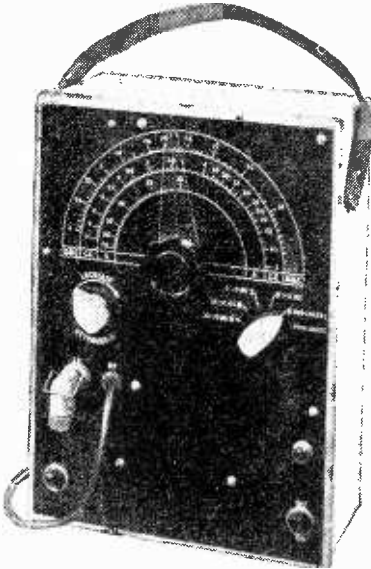

- Coverage 100 Kc/s-70 Mc/s (on fundamentals).
- Accuracy better than $\pm 2\%$ on all ranges.
- Large, clearly calibrated scale.
- Modulated or C.W. output.
- 500 c/s A.F. source.
- S.G.M.I.—A.C. mains operation. Double wound, varnish-impregnated transformer, tapped 210/225/250 volts.
- S.G.B.I.—All dry battery operated.
- All components are by well-known manufacturers ensuring maximum reliability.
- Both types in quantity production.
- Illustrated leaflet available, price 2d.

WEYMOUTH RADIO MANUFACTURING CO., LTD.
CRESCENT STREET, WEYMOUTH, DORSET

data for **AUDIOPHILES** *

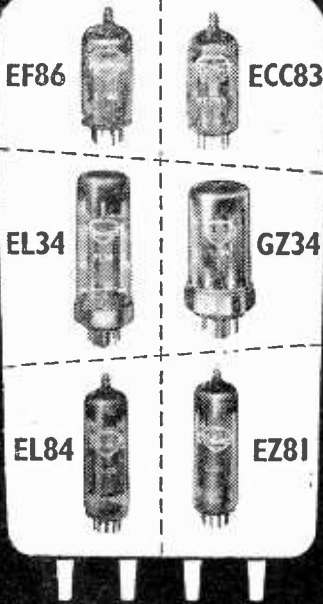

Audiophiles all over the world are demanding Mullard audio valves for their high quality sound equipment. And who can blame them when they know that the Mullard World Series of Audio Valves is the finest in the world. Fill in the coupon below for free data on Mullard World Series Audio Valves.

* *Audiophile—Enthusiast for high quality sound reproduction who is satisfied with nothing but the best.*

This popular book is available now from most dealers, price 3 6d. It contains designs and full constructional details of the new Mullard EL34 High Quality 20 Watt Amplifier, a Mullard Band II F.M. Tuner, pre-amplifiers for the Mullard EL34 Amplifier and for the popular Mullard 5 Valve 10 Watt Amplifier, together with other useful technical information.

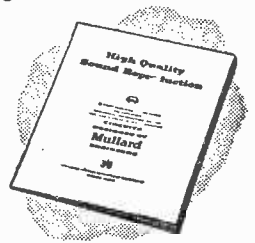

Mullard
WORLD SERIES
AUDIO VALVES



Mullard Ltd., Publicity Division,
Mullard House, Torrington Place,
London, W.C.1.

COUPON

To Mullard Ltd., Publicity Division
Please send me, free of charge, leaflets on the Mullard World Series of Audio Valves, and details of "High Quality Sound Reproduction".

NAME

ADDRESS

OUR 19/6 COLUMN

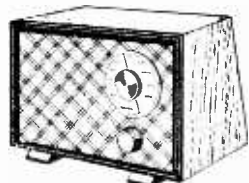

THE SKYSEARCHER

This is a 2-valve plus-metal receiver set useful as an educational set for beginners, also makes a fine second set for the bedroom, workshop, etc. All parts, less cabinet, chassis and speaker, 19/6. Post and ins. 2/6. Data free with parts or available separately 1/6. 3-valve battery version also available at the same price.

ALL-MAINS AMPLIFIER



Powerful three-valve Mains amplifier ideal for dances, parties, etc. Complete less chassis, cabinet and speaker (available if required)—data 1/6 (free with parts). Price 19/6, plus 2/6 post and insurance.

'CHIMELITE' 19/6



It is a hall light, as well as a double chime and you can make it in a couple of evenings for the total cost of only 19/6, including instructions, post 2/- data available separately price 2/-.

Simplex Transistor Kit



Makes ideal bedroom radio, uses one transistor and one crystal diode. Complete less case 19/6, case 5/- extra, post and ins. 1/6

A.C./D.C. Multimeter Kit

Measures A.C./D.C. volts and ohms. All the essential parts including 2in. moving coil meter, selected resistors, wire for shunts, range selector switches, calibrated scale and full instructions, price 19/6 plus 19 post and insurance.

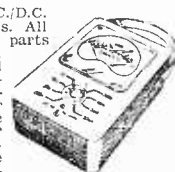

BAND III CONVERTER

Suitable London, Midlands, North, Scotland, etc. All the parts including 2 valves, coils, fine tuner, contrast control, condensers, and resistors. (Metal case available as an extra.) Price only 19/6, plus 2/6 post and insurance. Data free with parts or available separately 1/6.

THE EASIER TO BUILD T.V.

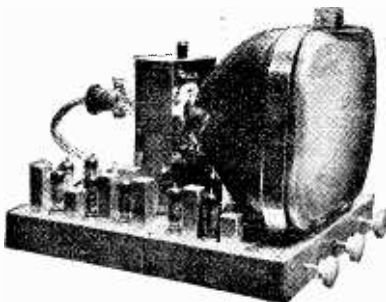

Undoubtedly the most up-to-date televisor for the home constructor. You can build it in an evening and the set when finished will be equal to a factory-made equivalent. What other constructor T.V. has all these features?

- ★ Made up units if required.
 - ★ All miniature valves.
 - ★ Metal rectifier.
 - ★ Turret tuner.
 - ★ 12-channel circuitry.
 - ★ Multi-vibrator timebases.
 - ★ Ferruxcube, E.H.T. and scan coils.
 - ★ 34 38 Mc/s I.F.
 - ★ Suitable for any modern 12, 14 or 17in. tube.
- The building cost (less tube) is only £29.10.0, plus 10/- carriage and insurance. All parts guaranteed 12 months. Full information and data, price 3/6.

TAPE DECK SNIP

TAPE DECK—Made by the famous Truvox Company. This contains exactly the same essentials as the current model. Only the styling is different. It also takes the stereophonic head. Specification: 3 B.T.H. shaded pole motors with silent friction drive eliminating wow and flutter. Push-button controls, electrically and mechanically interlocked. Patented-electric type push-button controlled brake. Tape loading on the drop-in principle, accommodation for reels of 7in. diameter. Tracking sense to British and American standards. Playing times: up to 3 hours with L.P. tape or 2 hours with L.P. tape or 2 hours with Standard tapes. Two tracks side by side with safety cap. Positive Azimuth adjustment of Record/Player head. High Impedance Heads. Overall size 14in. x 12in. x 5in. approx. 123 only of these fine decks offered at non-repeatable price of £17.10- or £3 10- down and eight monthly payments of £3. Non-callers add 10/- carriage and insurance.

14" T.V. CABINET

14in. T.V. cabinet of the latest styling made for one of our most famous firms—beautifully veneered and polished—limited quantity—19/6 each. Carriage and packing 3/6 extra.

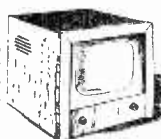

LAST FEW

HIGH FIDELITY AMPLIFIER

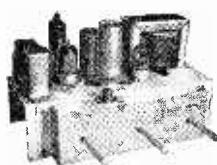

3 valve 4 watt with frequency response better than 40-15,000 C.P.S. Control Panel size 8 x 2 1/2in. comes fixed to chassis but is intended for independent mounting. Separate bass and treble controls giving fullest variation of cut and lift. Separate switch, absolutely no mains hum. Remarkable value at £4.19/6.

W.D. CIRCUIT DETAILS

Diagrams and other information extracted from official manuals. All 1/6 per copy, 12 for 15/-.

American Service Sheets	R. 100
A.1194	78 receiver
BC.348	76 receiver
BC.312	R28/ARC5
R.103A	R1116/A
BC.342	RA-1B
TA-1B	A38D
R-208	AN/APA-1
R-1155	78
R-1121A	76
R-1132A/R-1401	R.T.10
R-1147	CAY-46-AAM-
R-1224A	RADAR
R-1082	A.S.B.-3
R-1355	Indicator 62A
E.C.1206-A/B	Indicator A.S.B.3
B-455-A (or-B)	Indicator 62
B-454-A (or-B)	Indicator 6K
B-453-A (or-B)	R.F. unit 24
Transmitter T1154	R.F. unit 26
Fifty-eight walkie talkie	R.F. unit 25
Frequency meter	R.F. unit 27
B.C. 221	Wireless set No.19
	Demobbed valves

MINIATURE COMPONENTS for transistor sets, deaf aids, etc.

Made by Fortiphone and other famous firms.

Intervalve transformer, N22	10/-
Intervalve transformer, N23	10/-
Push pull input transformer, A233	15/6
Push pull output transformer, A204	15/6
Earphone Type 'L' 250 ohm	18/-
Plastic earlip	2/9
Tinsel flex and Plug for earphone	5/-
Slide switch ref. SWR	4/-
Pots with switch 4 meg	2/-
Very small resistors, many values	6d.
Very small condensers, prices from	6d.
Tinsel leads without plugs	6d.
Deaf aid cases with clip for pocket	2/6
Plastic box with lid 4 1/2 x 3 x 1 1/2 in.	2/6

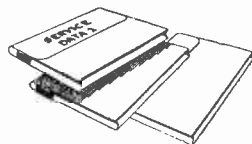

SERVICE DATA

100 service sheets, covering British receivers which have been sold in large quantities and which every service engineer is ultimately bound to meet. The following makers are included: Aerodyne, Alba, Bush, Cossor, Ekco, Ever-Ready, Ferguson, Ferranti, G.E.C., H.M.V., Kolster Brandes, Lissen, McMichael, Marconi, Mullard, Murphy, Philco, Philips, Pye, Ultra. Undoubtedly a mine of information invaluable to all who earn their living from radio servicing. Price £1 for the complete folder.

INSERT MICROPHONE

Ref. No. Mic 253-A, a really beautifully made magnetic mike of little over 1in. in diameter. Price 3/6, post free.

METER MOTORS

These are very small A.C. mains operated motors which have many applications for driving toys or other light loads. All are in good condition, but not new, having been stripped from electric light meters. Final speed of approx. 1 rev. per hour. Price 8/6 each. Post and insurance 2/-.

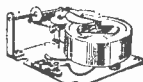

DON'T BE CAUGHT LIKE THIS



CAR STARTER CHARGER KIT

All parts to build 6- and 12-volt charger which can be connected to a "flat" battery and will enable the car to be started instantly. Kit comprising the following:

Mains transformer.....	22/6
5-amp rectifier.....	17/8
Regulator Stud Switch.....	3/6
Resistance Former.....	2/6
Mains on/off Switch.....	2/6
0.5 amp. Moving Coil Meter.....	12/6
Construction Data.....	1/6

Or if bought all together price is 52/6, plus 3/6 post and packing.

Yours for £11.00 Down

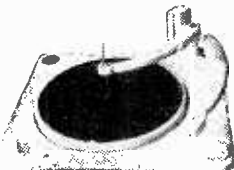

The latest most up-to-date Record Player made by the famous B.S.R. company. Using Hi-Fi Crystal Pick Up and fitted with every modern device. Definitely a record changer which will give years of trouble-free music. Not surplus but the current model. Price £8/10/- or £11/0/- deposit and 8 monthly payments of £1. carriage and insurance 5/-.

INSTANTUS HEATER

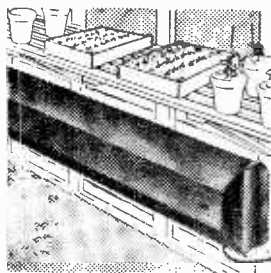

Convector heater, 1 kW. rating, 4ft. long, made from heavy gauge sheet steel (galvanised). Can be used for greenhouse, workshop, aviary, etc., etc. Price £2/10/-, or with thermostat, £4/5/-, carriage 5/-. GUARANTEED 5 YEARS.

2 KW MODEL. Free standing thermostatically controlled, £5/17/6.
500 WATT MODEL. For very small greenhouses, 32/6. Carriage 5/-.

CABINETS FOR ALL

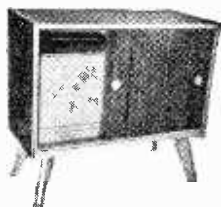

The CONTINA

Another addition to our range of cabinets. This is of new revolutionary design, styled after the best of continental radios. Externally, it is finished in highly polished dark walnut veneer, with panelling picked out in gold. Interior is of same very high standard, its veneer being light mahogany which contrasts nicely with the dark walnut and generally gives a very pleasing appearance. The doors slide on metal runners and are fitted with gold insert finger plates. A really excellent cabinet for any home—size 30.1 in. long, 11.1 in. deep, 2ft. 1 1/2 in. high, including legs which are 10 in. from floor. Motor board 12 1/2 in. x 17 in., equipment aperture 17 1/2 x 9 in. gives ample space for 8 in. speaker. Ample storage space for recordings. Price £19 19/-, carriage and insurance 2/-.

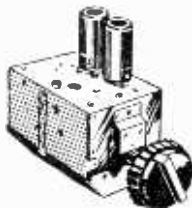

Turret Tuner

Brand new stock, not surplus, with coils for Band I and III complete with valves PCC81 and PCF90—L.F. Output 33 3/8 Mc/s with instructions and circuit diagram, 79/6. With knobs 3/6 extra, post and insurance 2/6.

CHARGING SWITCHBOARD

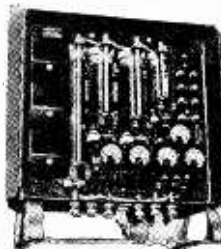

Offered at about one-twentieth of original cost. This is an ex-Government switchboard. It contains three reverse current relays, one voltmeter, one main ammeter, two secondary ammeters and three variable resistors for controlling circuits. These are original cases. Price £2/15/-, Carr. 10/-.

The "CRISPIAN" Portable Radio



A 4-valve truly portable battery set with very many good features as follows: Ferrite rod aerials, low consumption valves, superhet. circuit with A.V.C. ready-built and aligned chassis if required, beautiful two tone cabinet covered with I.C.I. rexine and Tygan. Guaranteed results on long and medium waves anywhere. All parts, including speaker and cabinet are available separately or if all ordered together the price is £7/15/- complete, or 35/- down and 7 payments of £1/0/0. post and ins. 3/6, ready-built chassis 30/- extra. Instruction booklet free with parts or available separately price 1/6.

MORGANITE POTENTIOMETERS

Single and 2 gang types available standard size with good length spindle all new and boxed. Single types 1" each, values available: 10K., 25K., 50K., 100K., 250K., 1 meg., 2 meg. Gang type, 3" each—values available: 5K., 10K., 25K., 50K., 100K., 1 meg., 2 meg.

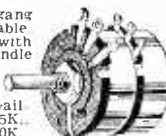

GLASS PANELS

Size 10 1/2 x 9 1/2—parcel of five panels. 7/6, plus 3/6 carriage.



CRYSTAL MICROPHONE

Miniature crystal type has high gain and is suitable for all purposes—tape recorders—amplifiers. Price 4/9, post and ins. 3d.



CERAMIC SWITCHES

By one of our best makers, 3 pole, 3 way, 2/6 each, also standard type switches 12 pole, 2 way, 1/3 each, 6 pole, 3 way, 1/3 each, 2 pole, 6 way, 1/6 each.

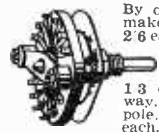

THERMOSTATS

Useful for the control of appliances such as convectors, gluepots, vulcanisers, hot plates, etc. Adjustable to operate over temperature range 50-550 deg. F., fitted with heavy silver contacts. 2 1/2 in. x 1 1/2 in. x 1 1/2 in. high. 11 amp. 3/6; 5 amp., 8/6; 2 amp. QMB. 5/6; 15 amp. QMB. 15/-, 15 amp. wall mounting type, 19/6.



SAPPHIRE NEEDLES

Unrepeatable bargain—new and perfect—two types available: miniature E.M.I. and Standard (trailer). Sale price 1/- each or 10/- doz.



TWIN FEEDER

Ideal for FM down lead, as a twin microphone lead, etc. Sale price 6/11, per yard, 80 ohm co-ax, low loss for Band III, 8d. per yard.

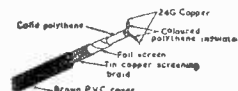

ELECTRONIC PRECISION EQUIPMENT, LTD.

Post orders to E.P.E., LTD., Dept. 7, Sutton Road, Eastbourne

286, London Road, Croydon. Phone: CRO 6558 Half day, Wednesday.

42-46, Windmill Hill, Ruislip, Middx. Phone: RUISLIP 5783 Half day, Wednesday.

152-3, Fleet Street, E.C.4. Phone: FLEET 2833 Half day, Saturday.

29, Stroud Green Road, Finsbury Park, N.4. Phone: ARCHWAY 1040 Half day, Thursday.

**3-4 WATT
AMPLIFIER**

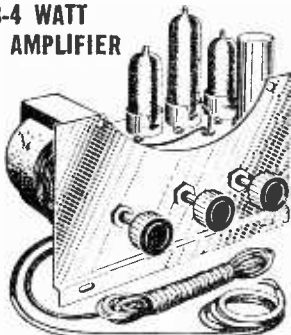

THREE VALVE TYPE (ECC83, EL84, EZ80). A high quality amplifier designed to satisfy the requirements of the more discriminating record enthusiasts. Three controls give a very wide variation of tone. Output approx. 2 watts. Fully isolated chassis. Overall size approx. 6½ in. x 5 in. x 2½ in.

PRICE **79/6** Plus 2/6 P.P.

**THE SUPEREX "55"
BATTERY
PORTABLE**



**BUILDING COST
£7 - 15 - 0**

Plus 5/- P.P.

Cabinet size,
10½ in. x 8½ in. x 4½ in.

- ★ 4-VALVE SUPERHET.
- ★ LONG/MEDIUM WAVES.
- ★ 7in. x 4in. SPEAKER.
- ★ B7G 1.4 v. VALVES.
- ★ SIMPLE CONSTRUCTION.

SEND 1/6 FOR BOOKLET.

SUPERIOR BUREAU



An elegant cabinet in richly figured walnut veneer, internal panels in polished sycamore. A drop front lid covers a sloping, uncut control panel (16in. long x 10½ in. high) alongside which is an uncut base-board (15½ in. long x 13½ in. back to front). The inside of the drop front lid is panelled in beige leatherette. In the lower part of the cabinet are two large storage cupboards (13½ in. high, 7½ in. wide, 16½ in. deep). The lid and cupboard handles are in chased Florentine bronze. Overall dimensions (33in. high, 34in. long, 16½ in. deep) **161 GNS.**

PRICE **2/2** Plus 25/- carriage.

CHASSIS ASSEMBLY

CONTAINING :

- ★ Punched chassis, Backplate, etc. Size: 12in. x 7in. x 8in.
- ★ Multi-colour Glass Dial L.M.S.G
- ★ Drive Drum and Spindle.
- ★ Continental Control Knobs.

PRICE **22/6** Plus 3/6 P.P.

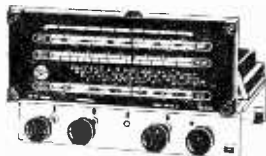

**SUPERIOR RADIO SUPPLIES,
37, HILLSIDE, STONEBRIDGE,**

N.W.10.

Phone: ELGar 3644

SHOP OPEN : 9 a.m. to 6 p.m. Monday to Saturday ; 1 p.m. Thursday.

TERMS : Cash with order or C.O.D. (U.K. and N. Ireland only).

Modernise Your Radiogram

with an *Armstrong* chassis

The effect of substituting a good quality Receiver/Amplifier for your ordinary commercial unit will astonish and delight you. Only in this way can the full benefits of the improved modern recordings and the superb quality of the VHF/FM transmissions be obtained. Armstrong have been making replacement chassis for nearly 25 years and have concentrated exclusively on the requirements of those who want the best. This is your guarantee of first-class performance and reliability.

MODEL AF 105 (illustrated) £37

AM and FM Tuners and High Fidelity Amplifier on one compact chassis

- ★ 10 valves ★ 10 watts
- Push-Pull output ★ 20 dB
- Negative Feedback ★ 5 wavebands including VHF

- ★ Independent wide range Bass and Treble controls with visual indicators
- ★ Magic Eye.

MODEL PB 409 28 Gns.

A high quality Radiogram Replacement Unit

- ★ 9 valves ★ 6 watts
- Push-Pull output
- ★ Negative Feedback
- ★ 4 wavebands including

- VHF ★ Quick action Piano Key selectors
- ★ Separate Bass and Treble controls
- ★ Magic Eye.

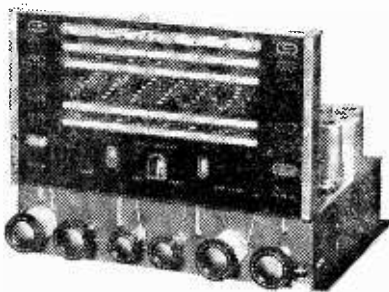

Post this coupon or write for descriptive literature and details of Home Trial facilities, Credit terms and Guarantee to Armstrong Wireless and Television Co. Ltd., Warrlers Rd., Holloway, N.7. Tel: NOR 3213. BLOCK CAPITALS PLEASE.

NAME

ADDRESS

Demonstrations at our Holloway Showroom 9-6 Weekdays and Saturdays. PWD

TOP QUALITY FULLY GUARANTEED VALVES BELOW MANUFACTURERS' PRICES

EXPRESS SERVICE !!!

C.O.D. ORDERS RECEIVED BY 3.30 P.M. EITHER BY LETTER, PHONE OR WIRE, DESPATCHED THE SAME AFTERNOON. ALL ORDERS RECEIVED BY FIRST POST DESPATCHED SAME DAY.

FOR ONLY 6d. EXTRA PER ORDER WE WILL INSURE YOUR VALVES AGAINST DAMAGE IN TRANSIT. ALL UNINSURED PARCELS AT CUSTOMER'S RISK.

0Z4	6/-	5AQ5	7/6	6L6G	9/-	12AH8	10/6	35/51	12/6	CV428	30/-	ECC81	8/6	EZ81	10/-	PCL82	12/6	UBF80	9/6
1A3	3/-	6AT6	8/6	6L7M	8/-	12AT6	10/6	35A5	11/-	DI	3/-	ECC82	7/6	GZ30	10/6	PCL83	12/6	UBF89	10/6
1A5	6/-	6AU6	10/6	6L18	13/-	12AT7	8/6	35L6GT	10/-	D42	10/6	ECC83	9/-	GZ32	12/6	PEN40DD		UCC85	10/6
1A7	15/-	6B4G	6/-	6N7	8/-	12AU7	7/6	35W4	8/6	D63	5/-	ECC84	10/-	GZ34	14/-		25/-	UCH42	10/-
1D6	10/6	6B7	10/6	6Q7G	8/6	12AX7	9/-	35Z3	10/6	D77	6/6	ECC85	9/6	H30	5/-	PEN45	19/6	UCH81	11/6
1H5	11/-	6B8G	4/-	6Q7GT	9/-	12BA6	9/-	35Z4GT	8/-	DAC32	11/-	ECC91	5/6	H63	12/6	PEN46	7/6	UCL82	13/6
1L4	6/6	6B8M	5/-	6R7G	8/6	12BE6	10/-	35Z5GT	9/-	DAF91	8/-	ECCF80	12/6	HABC80				UF41	9/-
1LD5	5/-	6BA6	7/6	6SA7GT	8/6	12E1	3/6	41MTL	7/6	DAF96	9/6	ECCF82	12/6		13/6	PL82	9/6	UF80	10/6
1LN5	5/-	6BE6	7/6	6SG7GT	7/6	12J5GT	4/6	50C5	12/6	DF33	11/-	ECH35	9/6	HK90	10/-	PL83	11/6	UF85	10/6
1N5	11/-	6B16	8/-	6SH7	6/-	12J7GT	10/6	50L6GT	8/6	DF91	7/-	ECH42	10/-	HL23	10/6	PM2B	12/6	UF89	10/6
1R5	8/6	6BR7	11/6	6S17	6/-	12K7GT	8/6	61BT	15/-	DF96	9/6	ECH81	8/-	HL41	12/6	PM12	4/6	UL41	10/6
1S5	8/-	6BV5	8/6	6SK7GT	6/-	12K8GT		61SPT	15/-	DH63	8/6	ECL80	10/-	HL133DD		PM12M	6/6	UL46	15/-
1T4	7/-	6BVW	9/-	6SL7GT	8/-		14/-	72	4/6	DH76	8/6	ECL82	13/6		12/6	PY80	9/-	UL84	11/6
1U5	7/-	6BX6	8/6	6SN7GT	7/6	12Q7GT	8/6	77	8/-	DH77	8/6	EF36	6/-	HVR2	20/-	PY81	9/-	UY41	8/6
2A3	12/6	6C4	7/-	6SS7	7/6	12SA7	8/6	78	8/6	DK32	15/-	EF37A	9/-	HVR2A	6/-	PY82	8/6	UY85	10/6
2A7	10/6	6C5	6/6	6U4G	14/-	12SC7	7/6	80	8/6	DK91	8/6	EF39	6/-	KL35	8/6	PY83	9/6	VI507	5/-
2C25	4/-	6C6	6/6	6USG	7/6	12SG7	7/6	83	8/6	DK92	12/6	EF40	15/-	KT2	5/-	QP21	7/-	VL5492A	£3
2D13C	7/6	6C8	8/-	6U7	8/6	12SH7	5/6	85A2	15/-	DK96	9/6	EF41	9/6	KT33C	10/6	QP25	15/-	VMP4G	15/-
2X2	4/6	6C9	12/6	6V6G	7/6	12SJ7	8/6	150B2	15/-	DL2	15/-	EF42	12/6	KT44	7/6	QS150/15		VP(7)	12/6
3A4	7/-	6C10	12/6	6V6GT	7/-	12SK7	6/-	1807	7/6	DL33	9/6	EF50(A)	7/-	KT63	6/6		10/6	VP(4)	15/-
3A5	12/6	6C16	7/6	6X4	7/-	12SQ7	8/6	866A	12/6	DL92	8/6	EF50(E)	5/-	KTW61	6/6	QVO4/7		VP13C	7/-
3B7	8/6	6D6	6/6	6XSGT	6/6	12SR7	8/6	956	3/-	DL94	9/-	EF54	5/-	KTW62	8/6		15/-	VP32	6/6
3D6	5/-	6E5	12/6	6Z4/84	12/6	12T4	10/6	1203	7/6	DL96	9/6	EF73	10/6	KTW63	8/6	R12	14/-	VP41	7/6
3Q4	9/-	6F1	15/-	6Z5	12/6	14R7	10/6	4033L	12/6	DL510	10/6	EF80	8/6	KTZ41	6/6	SD6	12/7	VR105/30	
3Q5GT	9/6	6F6G	7/-	630L2	12/6	14S7	14/-	5763	12/6	DM70	8/6	EF85	7/6	KTZ63	10/6	SP4(7)	15/-		9/-
3S4	8/-	6F6GT	8/-	7A7	12/6	19AQ5	11/-	7193	5/-	EA50	2/-	EF86	12/6	L63	6/6	SP41	3/6	VR150/30	
3V4	9/-	6F8	10/6	7B7	8/-	19H1	10/-	7475	7/6	EA76	9/6	EF89	10/-	MH4	7/6	SP42	12/6		9/-
5U4	8/-	6F12	9/-	7C5	8/-	20D1	16/-	9002	5/6	EAC80	7/6	EF91	9/-	MHL4	7/6	SP61	3/6	VT61A	5/-
5V4	12/6	6F13	13/-	7C6	8/-	20L1	13/6	9003	5/6	EAC91	7/6	EF92	6/6	MHLD6		TP22	15/-	VT501	5/-
5X4	10/-	6F16	9/6	7H7	8/-	25L6GT	10/-	9006	6/6	EAF42	10/6	L32	5/6			U16	12/-	W76	8/6
5Y3G	8/-	6F17	12/6	7Q7	9/-	25Z4G	9/6	AC/SPEN	7/6	EB34	2/-	EL41	10/6	ML4	12/6	U22	8/-	X61	12/6
5Y3GT	8/-	6F17	12/6	7Y7	8/6	25Z5	10/6	AC/HL	7/6	EB41	8/6	EL42	11/-	ML6	6/6	U25	13/6	X65	12/6
5Y4	10/-	6F33	7/6	7Y4	8/-	25Z6G	9/6	DDD	15/-	EB91	6/6	EL81	15/6	MU14	8/6	U31	9/6	X66	12/6
5Z3	12/6	6C6	6/6	8D2	3/-	28D7	7/-	AC/PA	8/-	EB33	7/6	EL84	10/6	OA10	12/6	U50	7/6	X79	12/6
5Z4G	10/6	6H6M	3/6	8D3	9/-	30	7/6	AP4	7/6	EB41	10/-	EL91	5/-	OA70	5/-	U52	8/-	XD(1.5)	4/-
6A8	10/-	6J5G	5/-	9D2	3/6	30C1	12/6	ATP4	3/6	EBF80	9/6	EM34	10/-	OA71	5/-	U76	8/-	XFV10	6/6
6A87	8/-	6J5GTG	5/6	10C1	15/-	30F5	12/6	AZ31	12/6	EBF89	9/6	EM80	10/6	OC72	30/-	U78	7/-	XFY12	6/6
6A88	9/-	6J5GTM	6/6	10F1	15/-	30FL1	12/6	B329	10/6	EC52	5/6	EY51		P61	3/6	U251	15/-	XH(1.5)	4/-
6AC7	6/6	6J6	5/6	10F9	11/6	30L1	12/6	BL63	7/6	EC54	6/-	(Small)	14/-	PABC90		U404	10/6	XSG(1.5)	4/-
6AG5	6/6	6J7G	6/-	10F18	12/6	30P4	15/-	CK505	6/6	EC70	12/6	EY51			15/-	UABC80		Y63	7/6
6AG7	12/6	6J7GT	10/6	10LD3	8/6	30P12	13/6	CK506	6/6	ECC31	15/-	(Large)	14/-					Z63	10/6
6AJ8	8/-	6K7G	5/-	10P13	17/6	30P16	10/6	CK523	6/6	ECC32	10/6	EZ35	6/6	PCC84	8/-			Z66	20/-
6AK5	5/-	6K7GT	6/-	11E3	15/-	31	7/6	CV63	10/6	ECC33	8/6	EZ40	8/6	PCC85	12/6	UAF42	10/6	Z77	9/6
6AL5	6/6	6K8G	8/-	12A6	6/6	33A/158M		CV85	12/6	ECC35	8/6	EZ41	10/6	PCF80	12/6	UB41	12/7	Z719	12/6
6AM5	9/-	6K8GT	11/-	12AH7	8/-	30/-		CV271	10/6	ECC40	15/-	EZ90	8/6	PCF82	12/6	UBC41	8/6	Z729	12/6

TERMS OF BUSINESS :-CASH WITH ORDER OR C.O.D. ONLY. ORDERS VALUE £3 OR MORE SENT POST/PACKING FREE. ORDERS BELOW £3 PLEASE ADD 6d. PER VALVE. C.O.D. ORDERS :-MINIMUM FEE, INCLUDING POST AND PACKING, 3/-. WE ARE OPEN FOR PERSONAL SHOPPERS. MON.-FRI. 8.30-5.30. SATS. 8.30-1 p.m.

ALL VALVES NEW, BOXED, TAX PAID, AND SUBJECT TO MAKERS' GUARANTEE. FIRST GRADE GOODS ONLY, NO SECONDS OR REJECTS. GOODS ARE ONLY SOLD SUBJECT TO OUR TERMS OF BUSINESS. OBTAINABLE FREE ON REQUEST. CATALOGUE OF OVER 1,000 DIFFERENT VALVES 3d.

We specialise in VALVES—of every kind and description—serving the industry for years. More than 2,000 different types in stock for IMMEDIATE DELIVERY—including hard-to-get and discontinued numbers. All valves exhaustively tested in our fully equipped laboratories, and re-tested at time of despatch. FULL NINETY DAY GUARANTEE. All valves individually boxed.

BENTLEY ACOUSTIC CORPORATION LTD.

THE VALVE SPECIALISTS
38 CHALCOT ROAD, LONDON, N.W.1

PRImrose 9090

PLEASE ENQUIRE FOR ANY VALVE NOT LISTED. 3d. STAMP, PLEASE.



Stern's "fidelity" TAPE RECORDER

IT HAS EVERYTHING—EXCEPT A HIGH PRICE

TESTED AND APPROVED AT THE TRUVOX LABORATORIES

IT INCORPORATES: The NEW TRUVOX Mk. IV TAPE DECK together with the "fidelity" MODEL HF/TR2 TAPE AMPLIFIER (both illustrated on this page), and a Rola 10in. x 6in. P.M. SPEAKER.

PRICE... Including CRYSTAL MIKE and 1,200ft. reel of PLASTIC TAPE.

£49. 10. 0.

(OR £3 EXTRA WITH REV. COUNTER.)

● BEFORE CHOOSING YOUR TAPE RECORDER YOU SHOULD HEAR THIS MODEL—TRULY "HI-FI" RECORDINGS ARE OBTAINABLE and it is comparable to much higher priced Recorders.

Alternatively send S.A.E. for ILLUSTRATED LEAFLET.

Plus £11/10/- carriage and insurance, of which £1 is refunded on return of Packing case.)

CREDIT SALE: Deposit £12/8/- and 9m'thly payments of £4/10/8. HIRE PURCHASE: Deposit £24/15/- and 12 monthly payments of £2/5/11.

The "fidelity" TAPE AMPLIFIER Model HF/TR2 WITH POWER SUPPLY UNIT

PRICE **£16. 0. 0.**

(Carr. and ins. 6/-)

H.P. TERMS: Deposit **£8** and 9 months of **£1.**

CREDIT TERM:

Deposit **£4** and 9 monthly payment of **£1/6/4**. When ordering, please advise make of deck in use. Send S.A.E. for full details.

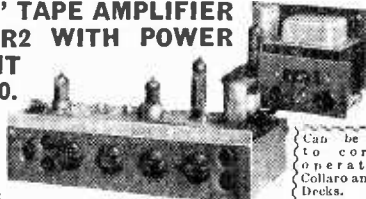

(Can be supplied to correctly operate with Collaro and Truvox Decks.)

The NEW TRUVOX MkIV TAPE DECK ONE OF THE BEST DECKS ON THE MARKET.

PRICE (Plus 10/- carr. and ins.) **£27. 6. 0.**

CREDIT TERMS: Deposit **£6/17/-** and 9 monthly payments of **£2/10/-**

H.P. TERMS: Deposit **£13/12/-** and 12 monthly payments of **£1/5/4**.

WE ALSO HAVE A FEW DECKS WITH REV. COUNTERS. Price **£30/9/-** Send S.A.E. for details.

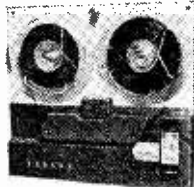

HOME CONSTRUCTORS We can supply a COMPLETE KIT OF PARTS to build this TAPE AMPLIFIER for **£12** (plus 5/- carr. and ins.). The Assembly Manual, Practical Diagrams, etc., are available for **2/6**. WE MAKE SPECIAL PRICES TO PURCHASERS OF TAPE EQUIPMENT (i.e., buyers of Deck and Amplifier together, etc., etc.). SEND YOUR ENQUIRY TO US... H.P. and CREDIT SALE TERMS ARE AVAILABLE.

WHY NOT HAVE A COMBINED "TAPE-RECORDER-RADIOGRAM" ?

We will quote for HIGH QUALITY AMPLIFIER-RADIO TUNING UNIT together with TAPE EQUIPMENT and GRAM UNIT (if required). This can be constructed for as little as **£70.0.0.** (plus Cabinet and Speaker). Send SAE with enquiry.

MODERNIZE YOUR OLD RADIOGRAM

The NEW ARMSTRONG PB. 409 A.M./F.M. Radiogram Chassis

"A chassis for those who want the highest quality." ● A 9-valve line up employing the latest MULLARD preferred-type valves. ● Provides complete coverage of the V.H.F. F.M. Transmissions plus the Short, Medium and Long Wavebands. ● Has Push-Pull Output with Negative Feedback for watts peak Output. ● Quick Action "Fine Key" Selectors and separate Bass and Treble Controls. ● Has "Magic Eye" Tuning Indicator. ● Dimensions 13in. x 9 1/2in. x 8in. high. Dial size 1 1/2in. x 5 1/2in. PRICE **£29. 8. 0.** TERMS: Credit **£7.7.0** and 9 monthly payments of **£2.14.0**. Plus 6/- carr. & ins.) H.P. **£14.14.0** and 12 monthly payments of **£1.7.3**. SEND S.A.E. FOR ILLUSTRATED LEAFLET.

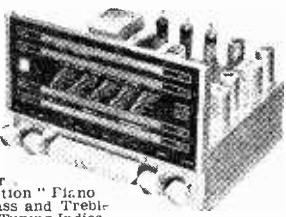

STERN'S "F.M." TUNING UNIT

A 5-valve Tuner incorporating the latest Mullard Permeability Tuning Sheet and a "Magic Eye" Tuning Indicator PRICE ASSEMBLED **£14.10.0.** READY FOR USE:

(Plus 7/6 carriage and insurance. TERMS: (a) Hire Purchase: Deposit **£7.5.0** and 9 monthly payments of **18/4**. (b) Credit: Deposit **£3.12.6** and 9 monthly payments of **£1.6.7**.



HOME CONSTRUCTORS—You can build this unit for **£10.0.0**. Full Assembly Instructions are available for **1/6**.

A TAPE PRE-AMPLIFIER and ERASE UNIT

STERN'S MODEL HF/TR1—A completely assembled Pre-amplifier with own Power supply. Can be supplied correctly matched for use with Truvox or Collaro Decks and incorporates Recording Level Indicator and Monitoring facilities. Please send S.A.E. with any enquiry. (Plus 5/- carr. and ins.) PRICE **£11. 10. 0.** SPECIAL PRICE REDUCTION WHEN PURCHASED WITH TAPE DECK.

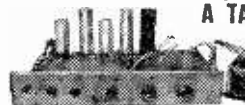

WE HAVE THE FULL RANGE OF DULCI CHASSIS IN STOCK

THE MODEL H.4. is illustrated but all Chassis and Tuners are similar—send S.A.E. for leaflets. H.P. and CREDIT SALE TERMS are available. Send S.A.E. for details. RADIOGRAM CHASSIS—These two Chassis are really well designed and reproduce most excellent quality on both Radio and gram. MODEL H.3. A 3 Waveband AM/FM CHASSIS **£20.17.0**. MODEL H.4. A 4 Waveband AM/FM CHASSIS **£24.6.6**. MODEL H.4/T. A 4 Waveband AM/FM TUNER with self-contained POWER SUPPLY **£20. 17. 0.**

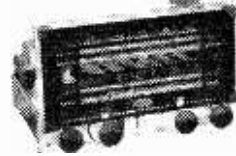

RECORD PLAYERS

at Greatly Reduced Prices Send S.A.E. for ILLUSTRATED LEAFLET "CASH ONLY" **£87.6.** (plus 5/- carr. & ins.)

THE VERY LATEST MODELS OFFERED

THE NEW 4-SPEED B.S.R. MONARCH

- A "MIXER" Auto-changer complete with High Fidelity Crystal "Turn-over" head.
- Incorporates the Manual Control position

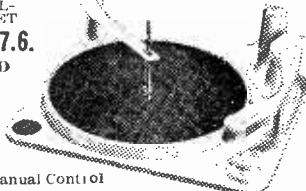

STERN RADIO LIMITED

COMPLETE KITS of PARTS for the "Hi-Fi" ENTHUSIAST

STERN'S REMOTE CONTROL UNIT

Designed in particular for use with the MULLARD 5-10 Main Amplifier

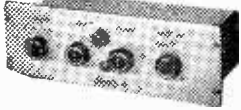

Ideally suited for simple domestic installation as an alternative to the more elaborate Pre-amplifier (shown and described opposite). Tone Control facilities are really excellent and in conjunction with the "5-10" Main Amplifier reproduction is of very high quality. Perfectly suitable for use with all the popular Record Players (B.S.R., Colaro, Gram) and the modern Radio Tuner Units. Front Panel contains: (a) Coloured Indicator, (b) Separate BASS and TREBLE CONTROLS, (c) 3 position Selector Switch, (d) Volume control. Inputs on back for Radio and Gram, and Gram equalising is incorporated.

FULL DATA is contained in the 5-10 MAIN AMPLIFIER MANUAL at 1/6.

The MULLARD "5-10" MAIN AMPLIFIER

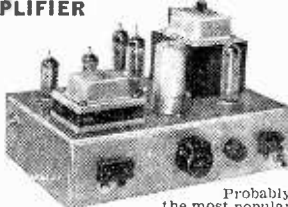

Probably the most popular and successful Amplifier yet designed and certainly needs no recommendation from us. Our kit is complete to MULLARDS specification including the latest ULTRA LINEAR OUTPUT TRANSFORMER and the recommended Mullard Valve line-up. All specified Components are supplied and Power Supply is available to drive a Radio Tuner Unit.

PRICE OF COMPLETE KIT OF PARTS (Plus 5/- carr. & Ins.) **£9.10.0** or alternatively we supply FULLY ASSEMBLED and TESTED for **£11.10.0** (Plus 5/- carr. & ins.). THE ASSEMBLY MANUAL containing FULL SPECIFICATION is available for 1/6. It also includes full data on the REMOTE CONTROL UNIT.

STERN'S "fidelity" PRE-AMPLIFIER TONE CONTROL UNIT

"A design for the Music Lover"



This unit can be used with any Main Amplifier. Briefly it has inputs for all types of MICROPHONES, HIGH and LOW GAIN PICK-UPS and a RADIO TUNING UNIT. It incorporates (a) GRAM EQUALISING CONTROL, (b) STEEPCUT FILTER, (c) Continuously variable BASS and TREBLE CONTROLS, a variable OUTPUT CONTROL which enables its use with any type of Amplifier, and Jack Sockets on Front Panel for TAPE RECORD and TAPE PLAYBACK.

Used with the "5-10" the reproduction is comparable to that normally associated only with the very expensive commercially made High Fidelity Amplifiers. PRICE **£6.6.0** OF COMPLETE KIT OF PARTS **£6.6.0** WE ALSO OFFER IT ASSEMBLED READY FOR USE, £8 (plus 5/- carr. & ins.). THE ASSEMBLY MANUAL contains full specification, and is available for 1/6.

BRITAIN'S FINEST "Hi-Fi" AMPLIFIER THE GENUINE WILLIAMSON

STILL SETS THE STANDARD FOR ALL AMPLIFIERS

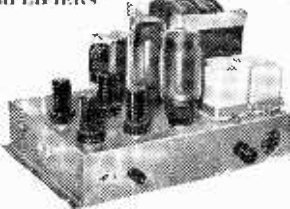

Many versions of the Williamson have been offered to the public at various low prices, but the "only Williamson" is the Amplifier built to the designer's specification and employing only the very high grade Components, i.e., PARTRIDGE TRANSFORMERS, CHOKES, etc., that he specifies. It is only in doing this that the exceptionally high standard that has made this Amplifier so famous, particularly in America, is obtained... WE HAVE DONE THIS... and we offer these KITS OF PARTS including Partridge and other high grade Components as follows:

- (a) To build the MAIN AMPLIFIER ONLY (illustrated above). **£14.10.0**
 - (b) To build the TWIN POWER SUPPLY UNIT ONLY (insufficient in space to illustrate this). **£13.10.0**
 - (c) COMPLETE KIT to build both above. **£27.0.0**
- We will also supply both COMPLETELY ASSEMBLED and will be pleased to quote. Credit and H.P. Terms are available. The complete SPECIFICATION and general ASSEMBLY INSTRUCTIONS are available for 3/6.

Our "fidelity" PREAMPLIFIER illustrated and described above (or alternatively the R.C.A. Pre-amplifier at £18.5.0) is recommended for use with the Williamson.

CALLERS ONLY

We have in stock various designs for HOME CONSTRUCTORS including F.M. Tuners, A.M., P.M. Tuners, Midrange Battery Portable, Mains Units, etc., etc.

(Dept. P.W.)

109 & 115 FLEET ST., LONDON, E.C.4.

Telephone: FL Eet 5812/3/4.

SPECIAL PRICE REDUCTIONS... WE OFFER YOU...

- (a) The COMPLETE KIT of PARTS to build both the MULLARD 5-10 and the REMOTE CONTROL UNIT for..... **£11.11.0**
 - (b) The COMPLETE KIT of PARTS to build both the MULLARD 5-10 and the "Fidelity" PRE-AMPLIFIER TONE CONTROL UNIT for..... **£15.15.0**
 - ALTERNATIVELY WE WILL SUPPLY ASSEMBLED and FULLY TESTED, as follows—
 - (a) The MULLARD 5-10 and the REMOTE CONTROL UNIT for..... **£14.0.0**
 - CREDIT SALE TERMS, £3.10.0 Deposit and 9 monthly payments of £1.5.8. 11.P. TERMS, £7 Deposit and 9 monthly payments of 17/9.
 - (b) The MULLARD 5-10 and the "Fidelity" PRE-AMPLIFIER-TONE CONTROL UNIT for..... **£18.18.0**
 - CREDIT SALE TERMS, £4.15.0 Deposit and 9 monthly payments of £1.14.7. 11.P. TERMS, £9.9.0 Deposit and 12 monthly payments of 17/6.
- WHEN ORDERING PLEASE INCLUDE 7/6 to cover cost of Carriage and Insurance.

THE MULLARD "3-3" QUALITY AMPLIFIER

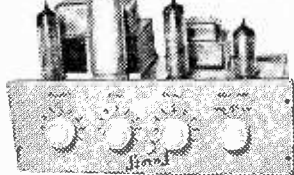

A small compact Amplifier capable of HIGH QUALITY REPRODUCTION on both RADIO and GRAM.

PRICE FOR COMPLETE KIT OF PARTS, **£6.19.6** (plus 6/6 carr. & ins.) Alternatively supplied ASSEMBLED and READY FOR USE **£8.12.6** (plus 6/6 carr. & ins.). The Complete SPECIFICATION and ASSEMBLY DIAGRAMS are available for 1/6.

Developed from the very popular 3 valve 3 watt Amplifier designed in the MULLARD LABORATORIES. We strictly adhere to the specification list; in addition we have added switched equalising for L.P. and H. Records and a position for Radio Inputs, plus additional power to feed a Radio Tuning Unit. Extremely simple to assemble and ideally suitable to incorporate with an F.M. Tuner or Record Player in a small installation.

- WE ALSO SUPPLY SEPARATELY—
 - (a) The 2-Stage (plus Rectifier) AMPLIFIER..... **£42.8**
 - (b) The PORTABLE CARRYING CASE..... **£3.17.9**
 - (c) 6in. P.M. SPEAKER..... **16/9**
- Carriage and insurance, 4/- extra. We also have a smaller PORTABLE CASE Ideal for Record Players. PRICE ONLY **£3.3.0** (plus 3/- carr. & ins.).

STERN'S "HIGH QUALITY" 8-10 WATT AMPLIFIER



Has power supply for Radio Tuning Unit

PRICE OF COMPLETE KIT OF PARTS (Plus 5/- carr. & ins.) **£7.10.0** SUPPLIED ASSEMBLED and READY FOR USE **£9.10.0**

Proved one of the most popular models yet offered to the HOME CONSTRUCTOR. Provides excellent reproduction up to 8 watts, employing 6V6's in push-pull, incorporating negative feedback. Provides for use of both 3 and 15 ohm speakers.

SPECIAL CASH ONLY OFFER !!

This very attractive PORTABLE AMPLIFIER CASE together with a good quality GRAM AMPLIFIER and a matched 6in. P.M. SPEAKER ALL FOR **£8.7.6** ONLY (plus 7/6 carr. & ins.).

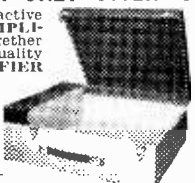

The Amplifier consists of a 2 Stage design incorporating the modern B.V.A. valves types ECC83, EL84 plus E280 Rectifier and has separate BASS and TREBLE CONTROLS. The Portable Case will also accommodate almost any make of Autochanger, and is attractively finished in Maroon and Grey colour Rexine.

TRANSISTOR TRANSFORMERS

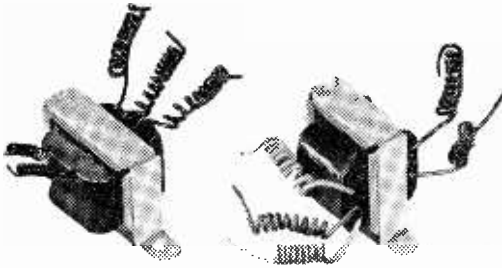

... two examples—a Driver and an Output type—from our miniature lightweight range.

150 mW Range	Size	Weight	Frequency	Price
Driver	1.11, 32"x13 16"x13, 16"	1oz.	120 c/s-17 Kc/s	13/-
Output	do. do.	do. do.	100 c/s-17 Kc/s	8/6
250 mW Range	Size	Weight	Frequency	Price
Driver	1.3, 4"x13, 16"x1.1, 8"	2oz.	50 c/s-16 Kc/s	14/6
Output	do. do.	do. do.	50 c/s-16 Kc/s	9/3

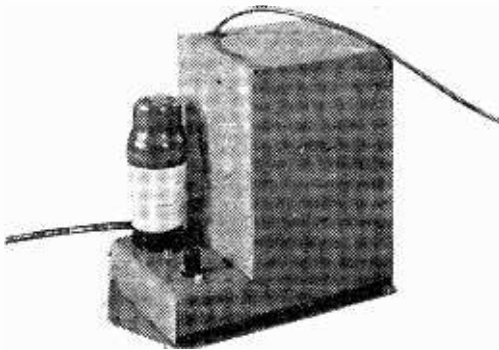

The NERA R.F. E.H.T. UNIT

... designed to provide a safe and reliable source of D.C. high voltage for all C.R.T.s including the new wide angle aluminised types. Output is continuously variable between 8-12 kV at approximately 500 μ A. Power supplies necessary are 6.3 v. at 1 amp., and 250/350 v. at 40 mA. Ample shielding prevents radiation and interference to broadcast receivers.

Price : £7 . 10 . 0

Coil and rectifier assembly only : £4 . 10 . 0

P.A.M Ltd MERROW · GUILDFORD SURREY
Tel. Guildford 2211

(One of the group of companies associated with the Southern Areas Electric Corporation Ltd.)

ELGE RADIO PEN

Versatile pocket Fault Finder

For Radio Television Amplifiers Transmitters Electronic Equipment

Combined Neon-Tester and Saw-tooth Generator

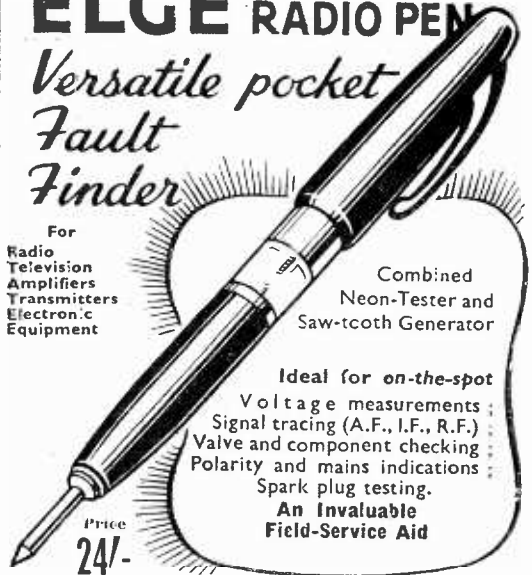

Ideal for on-the-spot Voltage measurements ; Signal tracing (A.F., I.F., R.F.) ; Valve and component checking ; Polarity and mains indications ; Spark plug testing. An Invaluable Field-Service Aid

Price 24/-

MERCIA ENTERPRISES LIMITED

Godiva House, Allesley Old Road, Coventry

Free leaflet on request.

Trade Enquiries invited

"ASPDEN" TAPE RECORDER KITS

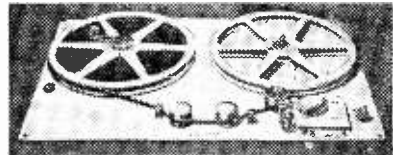

TAPE DECKS, 2-speed, twin track, easy to assemble kits with finest motor, Ferroxcube heads and full instructions.

MODEL 582 for 5in. spools, kit £8.5.0.

MODEL 782 for 7in. spools, kit £9.5.0.

Either model assembled and tested, 30/- extra.

AMPLIFIER kit, 2J watt, record/replay, 2 recording positions, neon indicator, etc., £5.18.0. Power pack kit for above, £2.18.6 (both without valves). Carr. and packing extra.

YOU CAN BUILD A QUALITY TAPE RECORDER

M.G. from Baghdad writes :—

"...really nice to have this amazing tap. deck."

D. B., Malaya, writes :—

"The recorder is now working as well as a commercial model and I am very pleased with it."

This tape deck and amplifier is being used in the Antarctic by an Expedition member.

Send stamp for full particulars to:—

W. S. ASPDEN Stanley Works, Back Cleveon Rd., BLACKPOOL, Lancs.

C.R.T. ISOLATION TRANSFORMER

Type A. Low leakage windings. Ratio 1:1.53 giving a 25% boost on secondary. 2 v., 10/6; 4 v., 10/6; 6.3 v., 10/6; 10.3 v., 10/6; 13.2 v., 10/6.
Type B. Mainly input transformer for use with 2 1/2 volt Tubes with falling emission. Input 2-2 1/2 volts. Output 2-2 1/2-2 1/2-3 volts at 2 amps. With Tag Panel, 17/6 each.
NOTE.—It is essential to use mains primary types with T.V. receivers having series-connected heaters.

TRIMMERS Ceramic. 30, 50, 70 pf., 9d.; 100 pf., 15 pf., 1/3; 200 pf., 1/6; 500 pf., 750 pf., 1/9.
RESISTORS. All values. 10 ohms to 10 meg., 5 w. 4d.; 1 w. 6d.; 1 w., 8d.; 2 w., 1/-.

12/6 PURETONE RECORDING TAPE

1,200 ft. on standard 7" Metal reels. Spools 5" metal, 1/6; 7" metal, 2/3- FERROVOIC 1,200 ft. Plastic Tape 25' on Platic Spools.

O.P. TRANSFORMERS. Heavy Duty 50 mA., 4/6. Mullinix, push-pull, 7/6. Miniature, 35d. etc., 4/6.
L.F. CHOKES 15-10 H. 60/65 mA., 5/-; 10 H. 80 mA., 8/6; 10 H. 150 mA., 12/6.
MAINS TRANS. 350-0-350, 80 mA., 6.3 v. tapped 4 v., 4 v., 5 v. tapped 4 v., 2 a., ditto 250-0-250, 22/6. Bargain 300-0-300 55 mA., 6 v., 4 a., 5 v., 2 a., 15/-.
HEATER TRANS. Tapped prim., 200/250 v., 3.3 A. 11 amp., 7/6; tapped sec. 2, 4, 6.3 v., 14 amp., 8/6; prim. 250 v. Sec. 6.3 v. 3 amp., 10/6.
ALADDIN FORMERS and core, 1in., 8d.; 1in., 10d. 6-3in. FORMERS 5897/8 and Cans TV1/2. 1in. sq. x 2in. and 3in. sq. x 1 1/2in. 2/- each, with cores.
TYANA.—Midget Soldering Iron 200/220 v. or 250/250 v., 16/9. Solon Instrument Iron 24/-.

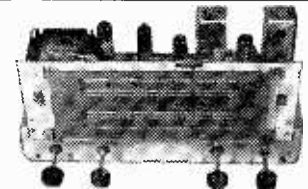

1957 RADIOGRAM CHASSIS

THREE WAVEBANDS. FIVE VALVES N.W. 16 m.—50 m. LATEST MULLARD M.W. 200 m.—550 m. ECH42, EF41, EB41, L.W. 500 m.—2,000 m. E141, E240. 12 month guarantee.
A.C. 200/250 v. 4-way Switch; Short-Medium-Long-gram. A.V.C. and Negative feedback 4.2 watts. Chassis 12 1/2 x 5 1/2 x 2 1/2 in. (Glass Dial) 10 x 4 1/2 in. horizontal or vertical available. 2 Pilot Lamps, Four Knobs, Walnut or Ivory. Aligned and calibrated. Chassis isolated from mains.

10 gns. Carr. & Ins., 4/6.

TERMS: Deposit £5.50 and six monthly payments of £1.
MATCHED SPEAKERS for ABOVE CHASSIS 5in., 17/6; 10in., 25/-; 12in., 30/-.

RECOMMENDED FOR ABOVE CHASSIS

* COLLARO * HIGH-FIDELITY AUTOCHANGER 1957 Model RC456 7in., 10in., 12in. Records 16. 33. 45. 78 r.p.m. 4 SPEEDS—10 RECORDS With Studio "0" pick-up BRAND NEW IN MAKER'S BOXES

OUR PRICE £9.150 post free
TERMS: Deposit £5.50 and six monthly payments of £1. Space required 14in. x 12 1/2in. 5in. above and 3in. below. Cut Out board. 6/-
GARRARD 4-SPEED RECORD CHANGERS RC120/4H 1957 Models Brand new and fully guaranteed 12 months.

AUDIO PERFECTION

Designed to play 16, 33, 45, 78 r.p.m. Records, 7in., 10in., 12in. Lightweight X-tal pick-up, turnover head, two separate sapphire styli for Standard and L.P., each plays 2,000 records. Voltage 200, 250 A.C.

OUR PRICE £10.150 each. Post Free.

Terms: Deposit £6 and 6 monthly payments of £1. Space required 14in. x 12 1/2in. 5in. above and 3in. below. Cut Out board. 6/-
AMPLIFIER—RECORD PLAYER CABINETS. Cabinet size 18 1/2in. x 12 1/2in. Ht. 8 1/2in. with motor board 14 x 12 1/2in., 23.3.0 post 3/-.

ALUMINIUM CHASSIS. 18 s.w.g. undrilled.

With 4 sides, riveted corners and latice fixing holes, 2 1/2in. sides, 7 x 4in., 4 1/2 x 6in., 5 1/2 x 11 x 1in., 6 1/2 x 9in., 8 1/2 x 11 x 1in., 10 1/2 x 15 x 1 1/2in., 12 1/2 x 18 x 1 1/2 x 3in., 16 1/2 x 21 x 3in.

TRANSISTORS. Audio, 10/-; R.F. 2.6 Me/s., 21/-. Mullard OCT1, 20/-.

SUPERHET COIL PACK. 27/6. Miniature size 2 1/2in. x 2 1/2in. x 1 1/2in. HIGH Q "Q" Dust coated Coils. Short, Medium, Long, Gram Switching. Single hole fixing with connection diagram and circuit. 465 Kc/s I.F.

COLLARO 4-speed Motor and Turntable with selecting switch for 16, 33, 45, 78 r.p.m. records. 200-250 v. A.C. 50 cps. Also HIGH FIDELITY Lightweight Pick-up Area X-tal turnover head, separate Sapphire styli for L.P. and Standard records. SPECIAL OFFER. THE TWO! £4.12.6. post 2/6. Cut Out Board, 1 1/2 x 12 1/2in. 6/-.
SUITABLE AMPLIFIER-PLAYER CABINET. Ready cut out for above. 45/-.

CRYSTAL MIKE INSERT by Acos, precision engineered. Size only 1 1/2 x 3/16in. Bargain Price 6/6. No transformer required.

CHAMPION VHF (FM) TUNER, 88-96 mc/s. 5 Mullard valves and superb tuning heart. Maroon and cream receiver styled cabinet 12 x 6 x 6 in. Features: This is a self-powered 250/250 v. A.C. VHF (FM) Amplifier with operating and servicing data and a screened lead for connection to pick-up sockets of any radio, radio-gram, or amplifier. Brand new with 12 months' guarantee. List price, 16 gns. Our price, 10 gns., carr. 4/6.

Volume Controls 80 ohm COAX Semi-pir spaced Poly-ethylene insulated. 1in. dia. Stranded core. 9d. yd. Losses cut 50% STANDARD 8d. yd. Lin or Log Tracks. 1in. Coax.

COAX PLUGS ... 1/- DOUBLE SOCKET ... 1/3 SOCKETS ... 1/- OUTLET BOXES ... 4/6 BALANCED TWIN FEEDER, yd. 6d. 80 or 300 ohms. DITTO SCREENED per yd. 1/-, 80 ohms only. WIRE-WOUND POTS, 3 WATT. Pre-set Min. T.V. Type. All values 25 ohms to 30 K, 3/- ex. 50 K, 4/-. (Carbon 50 K to 2 m., 3/-) WIRE-WOUND 4 WATT. Pots 2 1/2in. Spindle. Values, 100 ohms to 50 K, 5/6; 100 K, 8/6. CONDENSERS. New stock. 100 mfd. 7 kV., 10/4.5; 5/6; Ditto, 20 kV., 3/8; 100 pf. to 5,000 pf. Micas 6d.; Tubular 500 v., .001 to .01 mfd., 9d.; .05, .1, 1/-; .25, 1/6; .5, 350 v., 1/9; 1,500 v., 9d.; 1,600 v., 1/3; 1 mfd., 2,000 volts, 3/6. CERAMIC CONDS., 500 v., 3 pf. to .01 mfd., 10d. SILVER MICA CONDENSERS, 100 v. 5 pf. to 500 pf., 1/-; 500 pf. to 3,000 pf., 1/3. DITTO 19, 1.5 pf. to 600 pf., 1/9; 515 pf. to 5,000 pf., 2/-.

I.F. TRANSFORMERS 7/6 pair 465 Kc/s Slug tuning Miniature Can. 2 1/2in. x 1in. x 1in. High Q and good bandwidth. By Pye Radio. Data sheet supplied. Wearite M800 IF 465 Kc/s, 12/6 per pair.

Table with columns: TUBULAR, TUBULAR, CAN TYPES. Lists various electronic components and their prices.

NEW ELECTROLYTICS. FAMOUS MAKES. SENTERCEL RECTIFIERS. E.H.T. TYPE FLY-BACK VOLTAGES. K3/25 2 kV., 5/-; K3/40 3.2 kV., 7/-; K3/45 3.6 kV., 7/6; K3/50 4 kV., 8/-; K3/100 8 kV., 14/6. MAINS TYPE CONTACT COOLED 250 v., 50 mA., 8/6; 250 v., 85 mA., 9/6. CHL 45 Wearite, 4 1/2 in. 8/9, 3/- each. Osmer Midget, C.Q. Type add cost, 10/6 per 4/-.

TELETRON, J. & Med. T.R.P., with reaction, 3/6. FERRITE ROD AERIALS, M.W., 8/9; M. & L., 12/6. T.R.F. COILS A/H/F, 7/- pair. H.F. CHOKES, 2/6. FERRITE ROD 5in. x 3/8in., 2/6.

JASON P.M. TUNER COIL SET. 28" H.P. coil, aerial coil, Oscillator coil, two I.P. transformers 10.7 Mc/s. Detector transformer and heater choke. Circuit book using four 6AM6, 2/-; I.H. Chassis and Dial, 19/6. (Complete Jason P.M. Kit, 28.18.6.) With Jason superior calibrated dial, 28.15.0.

FULL WAVE BRIDGE SELENIUM RECTIFIERS 2.6 or 12 v., 11 amp., 8/9; 2 a., 11/3; 4 a., 17/6. CHL 45 TRANSFORMERS. Tapped 100 to 250 v. for charging at 2.6 or 12 v., 11 amp., 16/6; 2 amp., 17/6; 4 amp., 22/6. VALVE and T.V. TUBE equivalent, 6 s. TOGGLE SWITCHES, S.P. 2/-, D.P. 3/6. D.P.D.T. 4/-, WAVELENGTH SWITCHES. 5 p. 4-way 2 water, long spindle ... 2/6 2 p. 2-way, 3 p. 2-way, short spindle ... 2/6 2 p. 2-way, 4 p. 2-way, 4 p. 3-way, long spindle 3/6 3 p. 4-way, 1 p. 12-way, long spindle ... 3/6 VALVEHOLDERS. Pax. Int. Oct., 4d. EF50, EA30, 6d. B12A, CR1, 1/2. Eng. and Amer. 4, 5, 6, 7, and 9 pin, 1/- MOULDED MADE and Int. Oct., 6d. B7G, B8A, B8G, B9A, 9d., B7G with can, 1/4. VCR9, 2/6, B98 with can, 2/6. CERAMIC EF30, B7G, B9A, Int. Oct., 1/- B7G with can, 1/9. BLACK CRACKLE PAINT, air dries, 3/- tin

Table with columns: All Bored Valves New & Guaranteed. Lists various vacuum tube types and their prices.

NEW AND ENLARGED SHOWROOMS NOW OPEN OUR WIRELESS SPECIALISTS WITH EVERY PURCHASE. Please address all Mail Orders correctly as below.

RADIO COMPONENT SPECIALISTS 337 WHITEHORSE RD., WEST CROYDON

OPEN ALL DAY—(Wed. 1 p.m.) Catalogue 6/6. Tel. THO 1665. Buses 133 or 68 pass door. 43-hour postal service. P. & P. 1/-, over £2 post free. (Export Extra.) C.O.D. Service 1/6.

LASKY'S PAGE OF MONEY-SAVING OFFERS



COLLARO 4-SPEED MIXER AUTO-CHANGER

Latest model RC.456 incorporating auto and manual control enabling records to be played singly or automatically. Complete with Studio crystal P.u. and sapphire stylus. List £13 17/- LASKY'S PRICE **£8/19/6** Post 5/-.

TWO NEW LOW-PRICED SINGLE PLAYERS

B.S.R. TU9 4-speed motor and latest B.S.R. "Full-n" pick-up. £4 17/- Post 3/6. Motor only 59 6. Post 2 6. Pick-up only 37 6. Post 2 6.

COLLARO "Junior" 4-speed motor and pick-up with HGP59 cartridge. £4/12 6. Post 3 6.

BARGAIN OFFER! MINIATURE 6 to 12 v. MOTORS

Will work on any voltage from 6-12. Complete with gearbox. Overall size 2 1/2 in. long x 1 1/2 in. x 1 in. Ideal for models, remote control, etc. Original cost over £2.

SPECIAL PRICE **12/6** Post 1 6. Money refunded if not satisfied.

Teletron "Companion"

3 - TRANSISTOR POCKET RADIO. T.R.F. circuit covering medium and long waves, with balanced armature output, Ferrite aerial. Note small size: 4 1/2 x 3 x 1 in. Can be built for only **89/6** Full instructions and price list, 6d. post free. All components available separately.

LASKY'S F.M. TUNER

PRINTED CIRCUIT VERSION OF G.E.C. 912 "F.M. PLUS" TUNER FOR HOME CONSTRUCTION



TRANSISTORS

at a reasonable price

Hermetically sealed and unaffected by temperature variations. Tested and guaranteed efficient.

R.F. P.N.P. Junction Type, suitable for medium and low freq. oscillators, freq. changers and I.F. amplifiers (1.5 to 8 Mc s). **2/-** (Double spot—yellow and red.)

AUDIO P.N.P. Junction Type, suitable for high gain and low freq. amplifiers, and for output stages up to 250 milliwatts. **10/-** (Double spot—yellow and green.) Post Free.

Full operating data and circuit diagrams for receivers, oscillators, amplifiers, etc., supplied with each Transistor.



LASKY'S TRANSISTOR AMPLIFIER KIT

(200 milliwatts) FOR CONSTRUCTION ON PRINTED CIRCUIT

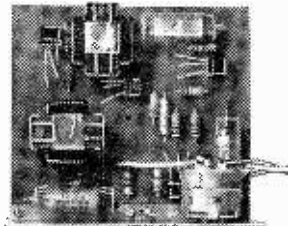

Miniature size: 3 1/2 in. x 3 1/2 in. Height can be under 1 in. Uses our hermetically sealed Transistors and operates from 6-volt battery. Output impedance 5 ohms. FULL DETAILS, circuit diagram and shopping list, 1/-, post free. All components available separately.

COMPLETE KIT including 4 Transistors, all brand new components, latest T.C.C. miniature condensers. PRINTED CIRCUIT and full instructions. **79/6**, post 3 6.

LASKY'S TRANSISTOR SUPERHET TUNER FOR HOME CONSTRUCTION

ON PRINTED CIRCUIT

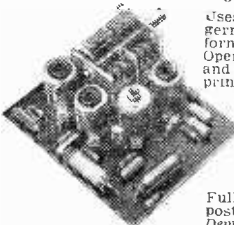

Uses 3 R.F. Transistors and 1 germanium diode, 3 I.F. transformers, Ferrite rod aerial. Operates from one 6 v. battery and one 1.5 v. cell. Size of printed circuit, 3 1/2 in. x 3 1/2 in.

CAN BE BUILT FOR ONLY

£5/12/9

Post 3/6

Full details and illustrations post free on request. Demonstrations at both addresses.

Note.—This Tuner in conjunction with our Transistor Amplifier (as above) makes an excellent Transistorised radio. Cabinets available.

CAN BE BUILT FOR ONLY 8 GNS.

Uses 5 valves, 2 germanium diodes and brand new T.C.C. condensers. The PRINTED CIRCUIT ensures that the I.F. and R.F. amplifiers are extremely stable at maximum gain and results are consistent on all tuners.

G.E.C. FM TUNER BOOK plus our full data and Shopping List, 2/6 post free. All parts available separately. ALIGNMENT SERVICE is available.

LASKY'S NEW MIDGET T.R.F.

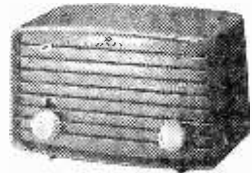

CAN BE BUILT FOR ONLY 99/6

Post & Pkg. 5/-

Handsome contemporary design case, overall size 3 1/2 in. wide, 4 1/2 in. deep, 5 in. high. 2 latest double-purpose valves EBF9 and ECL80, contact cooled rectifier. For A.C. mains 200-250 v. Med. and long wave. 3 in. F.M. speaker. Plastic cabinet in cream, pastel green, pink, blue. FULL DATA, instructions, circuit diagram and shopping list, 1/6 post free. All components available separately. CABINET only, as illus., 12/6 plus 4/6 post and pkg.

LASKY'S BATTERY PORTABLE



CAN BE BUILT FOR ONLY 7 GNS.

or as a main/battery job with 200 250 v. A.C. Power Unit for only 9 Gns.

Carr. and pkg. 3/6. Performance of this 3-valve, 2-wave superhet equals ready-built Portables costing pounds more. The PRINTED CIRCUIT supplied makes construction amazingly easy. Circuit diagram, full data, etc., 1/6 post free.

MULLARD 510 AMPLIFIER KIT WITH T.C.C. PRINTED CIRCUIT

All specified components used and you have your choice of transformers and chokes by Partridge, Haddon, W/B, Ellison or Gilson. Demonstrations given any time.

COMPLETE KIT

All parts and printed circuit for building the Mullard 510, from **9 Gns.**

Full details on request. Book, 3/6, post free. All components available separately. Also available built ready for use. Price according to transformers used.

LASKY'S RADIO

LASKY'S (HARROW ROAD) LTD.

42, TOTENHAM COURT ROAD, W.1. Telephone: MUSeum 2605.

370, HARROW ROAD, PADDINGTON, W.9. LADbroke 4075 and CUNningham 1979.

Open all day Saturday, early closing Thursday.

ALL MAIL ORDERS TO HARROW ROAD PLEASE

PRACTICAL WIRELESS

EVERY MONTH
VOL. XXXIII, No. 612, DECEMBER 1957
COMMENTS OF THE MONTH

EDITOR : F. J. CAMM

25th YEAR
OF ISSUE

BY THE EDITOR

THE SPACE AGE ARRIVES

AFTER years of scientific debate, the space age was born on October 6th by the successful launching by the Russians of their artificial satellite without a hitch. It has encircled the earth a large number of times at speeds estimated at 30,000 miles an hour. Although this issue goes to press some weeks in advance of publication, it may still be travelling on its orbit by the time these words appear.

It is a magnificent achievement and every credit must be given to the Russians for it. The space age has arrived, and this preliminary experiment, which must have far-reaching results, is but the precursor of many more experiments of a complicated nature which will lay the foundation of space travel, with the moon as the preliminary destination. The Bleep-bleep which has been received from its ingenious radio transmitter, itself a remarkable piece of mechanism, has given the whole world aural evidence that the satellite is functioning as it was designed to do. We have been able to witness its passage through the empyrean. It is travelling at an altitude of between 500 and 600 miles—the highest altitude ever attained by a mechanical object.

Notwithstanding the prior agreement by all nations that each would announce to the others when any such experiments were to take place, the Russians launched their satellite in secrecy, following it with the explanation that it was a doubtful experiment. The result was that all the observing posts throughout the world which were brought into existence in this geophysical year were unable in the early stages to make any observations, and our own radio telescope erected at enormous expense for this very purpose at Jodrell Bank was not able to make any contribution until some days had elapsed and the satellite had made some hundreds of circuits.

The experiment is of the highest importance to science, and it will have the effect of accelerating the activities in geophysics which is taking place in America and somewhat tardily in this country. It seems a pity that this country, which has done more than any other to advance the science of astronautics and probably knows more about it than any other, should have to take second place in a great scientific adventure of this sort because of lack of money. Had that money been forthcoming no doubt we should have been the first to have projected an artificial satellite into the heavens. It cannot be denied that the achievement of the Russians has greatly enhanced their world-wide prestige, even if it has caused some tremors in American scientific circles.

Incidental advantages which must follow from the launching of this satellite must benefit radio science. We shall know far more in the near future about cosmic rays and sun spots, and their effect on radio transmission. The advantage, of course, will be to short-wave, ultra-short wave and micro-wave transmissions, about which at present there is much to learn. In the course of the year there will be startling developments.—
F. J. C.

Our next issue, dated January, will be published on December 6th.

**Editorial and Advertisement Offices :
PRACTICAL WIRELESS**

George Newnes, Ltd., Tower House,
Southampton Street, Strand, W.C.2.
Phone : Temple Bar 4363.
Telegrams : Newnes, Rand, London.
Registered at the G.P.O. for trans-
mission by Canadian Magazine Post.

SUBSCRIPTION RATES

including postage for one year
Inland - - - 19s. per annum.
Abroad - - 17s. 6d. per annum.
Canada - - - 16s. per annum.

CONTENTS :

	Page
Editorial	679
Round the World of Wireless	680
Applications of OCP 71	682
Beginner's Constructional	
Course	685
Coil & Transformer Winder	689
Transistors in Practice	693
Tape Recorder Dictation	
Switch	697
On Your Wavelength	698
Transistorised Pulse	
Generator	701
Amplification at V.H.F.	703
Push Pull Gram Amplifier	706
Components, Faults and	
Testing	709
Microphones	713
Converting the Command	
Receiver	717
Inter-station Noise Suppres- sion	721
Transmitting Topics	725
Open to Discussion	733
Programme Pointers	737

The Editor will be pleased to consider articles of a practical nature. Such articles should be written on one side of the paper only, and should contain the name and address of the sender. Whilst the Editor does not hold himself responsible for manuscripts, every effort will be made to return them if a stamped and addressed envelope is enclosed. All correspondence intended for the Editor, should be addressed: The Editor PRACTICAL WIRELESS, George Newnes, Ltd., Tower House, Southampton Street, Strand, W.C.2. Owing to the rapid progress in the design of wireless apparatus and to our efforts to keep our readers in touch with the latest developments, we give no warranty that apparatus described in our columns is not the subject of letters patent.

Copyright in all drawings, photographs and articles published in PRACTICAL WIRELESS is specifically reserved throughout the countries signatory to the Berne Convention and the U.S.A. Reproductions or imitations of any of these are therefore expressly forbidden. PRACTICAL WIRELESS incorporates "Amateur Wireless."

Round the World of Wireless



By "QUESTOR"

Broadcast Receiving Licences

THE following statement shows the approximate number of Broadcast Receiving Licences in force at the end of August, 1957, in respect of wireless receiving stations situated within the various Postal Regions of England, Wales, Scotland, and Northern Ireland. The numbers include licences issued to blind persons without payment.

Region	Sound
London Postal... ..	1,140,231
Home Counties	1,151,120
Midland	873,507
North Eastern	1,144,139
North Western... ..	844,966
South Western... ..	725,247
Wales and Border Counties	457,839
<hr/>	
Total England and Wales	6,337,049
Scotland	824,797
Northern Ireland	192,178
<hr/>	
Grand Total	7,354,024

The Spacistor

FROM the U.S.A. comes news of a new semi-conductor amplifier. Resembling a valve rather than a transistor, this component is a reverse-biased p-n junction (negative voltage applied to the p section and position to the n section). The input and output impedances of the Spacistor are extremely high—about 30 megohms. Owing to the small output capacity it is expected that these components may be constructed to work at frequencies higher than 1,000 Mc/s.

VHF for Southampton

THE Southampton Harbour Board has awarded a substantial contract to Marconi's Wireless Telegraph Co. Ltd. for equipping the Port of Southampton Operation and Information Service with frequency-modulated V.H.F. radio. The equipment will conform to the standards laid down at the Hague Convention of January last and will form the basis of a new system of port communications that may eventually have a world wide application.

BBC Engineer Visits U.S.A.

THE BBC are sending their Head of Engineering Training Department, Dr. K. R. Sturley, to the United States to

study methods of training in broadcasting and radio engineering. He will see the work of the chief American broadcasting networks in New York and Chicago. The training methods used in industry and selected technical institutions in Washington, Cleveland, and Boston, will be examined. While there Dr. Sturley will be presenting three technical papers written by other members of the BBC Engineering Division for the Audio Engineering Society's Annual Convention in New York and for the Society of Motion Picture and Television Engineers' Convention in Philadelphia.

Private Mobile Radio Licences

AT the end of August there were 1,561 licences in force for private mobile radio services (excluding police and fire). These covered 1,805 base

stations and 13,010 mobile stations.

Details of the mobile stations from which messages are transmitted and received are as follows:—

Cars (including ambulances, cranes, taxis, etc.)	11,411
Ships (including small ships and tugs)	901
Hand portable stations	563
Transportable stations	133
<hr/>	
	13,008

A private mobile radio licence costs £3 for each of the first two stations and £2 for each additional station per year. Two new types of licence have recently been introduced; one, giving up to twenty-eight days coverage which makes it especially useful for shows and exhibitions, costs only £1. The other covers "inductive" paging systems and is used in hospitals and large buildings. The licence fee in this case is £2 for five years for an unlimited number of stations operated.



A contract, valued at £1,000,000 has been awarded to Marconi's Wireless Telegraph Co., Ltd. for the complete reorganisation of the L.F. broadcasting station at Ankara. The order includes the supply of a new 120 kW. L.F. transmitter which will be installed for parallel operation with the existing 120 kW. L.F. transmitter supplied by Marconi's in 1937, which has given extremely satisfactory service for 20 years. This illustration shows the transmitter hall at Etimesgut, Ankara, as it appears at present. The original 120 kW. transmitter supplied by Marconi's in 1937 can be seen on the left.

Award to Cossor Director

THE British Institution of Radio Engineers has announced the award of the 1956 Brabazon premium for the most outstanding contribution on radio and electronic devices for air-

receivers were up by 22 per cent.; for television receivers by 10 per cent. and for radiograms by 31 per cent.

The proportions of hire purchase and credit sales in August was 52 per cent. for television receivers (same as July); rose from 56 per cent. to 62 per cent. for radiograms; and fell from 36 per cent. to 33 per cent. for radio receivers.

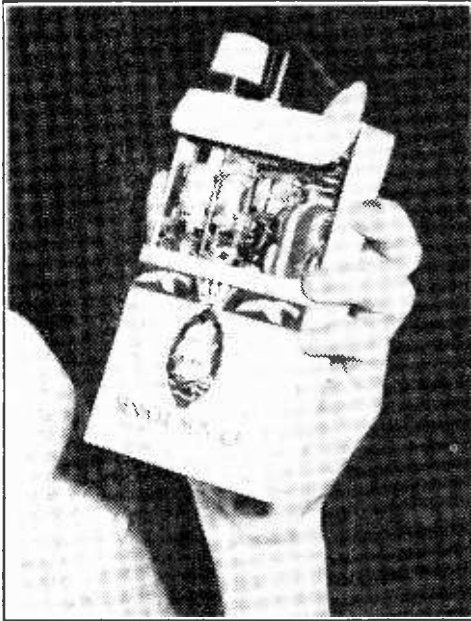

A miniature receiver seen at this year's Radio Show. It is not in production, but merely to show how small a receiver can be made. It was by Siemens-Ediswan and uses standard components.

craft safety to Mr. K. E. Harris, Technical Director of Cossor Radar and Electronics Limited, for his paper "Some problems of secondary surveillance radar systems."

This is the second such award in three years, as the 1954 Brabazon premium was given for a paper on "A high definition general-purpose radar" by four Cossor Engineers, Messrs. Jenkins, Evans, Chambers and Wallace.

Radio Sales Rise

RETAIL sales of radio and television receivers and radiograms for the first eight months of the year were higher than in the corresponding period of 1956. The monthly retail survey of the British Radio Equipment Manufacturers' Association shows that sales for radio

started 23 years ago. He leads not only in the designing and manufacturing of amplifiers, pickups and pre-amplifiers, but in the fundamental scientific research on sound reproduction. Recently he was awarded the "Dr. Norman Partridge Memorial Award" of the British Institution of Radio Engineers, for his paper on "High Fidelity Loudspeakers:

The Performance of Moving Coil and Electrostatic Loudspeakers." He is the only Britisher ever to receive the honour of being elected a Fellow of the Audio Engineering Society of America.

New Zealand Buys English Radar

FOLLOWING an exhaustive evaluation of equipment available both in Europe and America, the Civil Aviation Administration (Air Dept.) of New Zealand has awarded a contract to Marconi's Wireless Telegraph Co. Ltd., of Chelmsford, England, for the supply and installation of two complete surveillance radar systems.

One installation will serve the Cook Strait Zone and Rongotai Airport, which is currently under construction at Wellington, N.Z. The other is for use at Ohakea Airfield, a busy Royal New Zealand Air Force operational base. Both installations incorporate duplicate high-power (500kW) equipment of an entirely new type, the Marconi Type S264A.

Obituary

THE death is announced of Dr. Irving Langmuir at the age of 76. The inventor of the mercury vapour pump, he will be remembered for his pioneer work on high vacuum tubes.

Mr. Harold Leak to Visit the U.S.A.

MR. HAROLD J. LEAK, M. Brit. I.R.E., Chairman and Managing Director of H. J. Leak & Co., Ltd., is to visit New York.

He will spend much time at the New York High Fidelity Fair and will demonstrate some of the Leak equipment exhibited.

Mr Harold Leak is the doyen and leader in the field of Hi-Fi sound reproduction, having

LAST MINUTE CHRISTMAS GIFTS

There's still time to send your friends who are radio enthusiasts the ideal Christmas gift . . . a year's subscription for PRACTICAL WIRELESS. All through the year your gift will bring them repeated pleasure . . . every new issue, reminding them of your good wishes.

But hurry! You must send now to make sure that first copies arrive in time for Christmas. Simply send your friends' names and addresses, together with your own, and remittance* to cover each subscription to Subscription Manager (G.2), George Newnes, Ltd., Tower House, Southampton Street, Strand, London, W.C.2. An attractive Christmas Greetings Card will be sent in your name to announce each gift.

* RATES (INCLUDING POSTAGE) FOR ONE YEAR (12 ISSUES): U.K. 19s. 0d., OVERSEAS, 17s. 6d., CANADA 16s. 0d., U.S. \$2.50.

Applications of the OCP71

SOME USEFUL INFORMATION ON THE PHOTO-TRANSISTOR

By J. G. Ransome

THE photo-transistor is a normal p-n-p germanium junction transistor in which the inherent photo-electric effects are exploited. The normal transistor is sensitive to light, and it is for that reason that they are encased in a light-proof container. The photo-transistor has many advantages over the conventional vacuum or gas-filled types apart from those of a purely mechanical consideration. They are very much

the opaque coating damaged he may like to remove with acetone (nail-varnish remover) or a similar solvent, all of the covering material to expose the clear glass and try this modified transistor in the circuits shown. These may prove inferior, since the OCP71 has a special diffusing silicone grease to increase the sensitivity to light from all directions.

Characteristics

Dark current	300 μ A
Sensitivity with preferred direction of light	1.5—4mA
Cut off frequency	3 kc/s
Vc max.	-25 volts
Ic max.	-10mA
Pc max.	25 mW
Max. operating temp.	45°C.

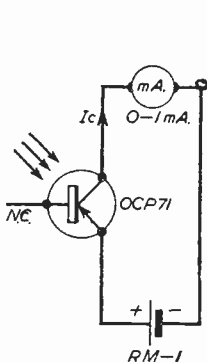

Fig. 1.—Basic circuit.

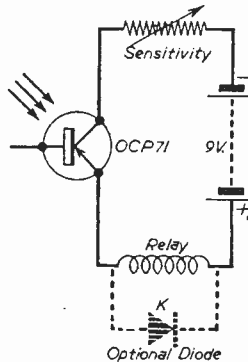

Fig. 2.—The alternative circuit.

COMPONENTS FOR FIG. 1

- 1 OCP 71.
- 1—Mallory cell type RM-1.
- 1 Meter 0-1 mA.

smaller, are much more sensitive, and do not need amplifiers to operate such devices as relays.

The photo-transistor to be used in the following circuits is the Mullard OCP71. If the constructor has a transistor of the OC70 or OC71 type which may have

First Circuit

The first application is for a small photo-electric exposure or luminous intensity meter. The circuit, in effect, measures the collector current, which varies with the degree of illumination on the junction. The whole unit was built inside the case of the meter, and the meter calibrated against a professional job borrowed from a friend. A small 1½ volt cell of the Mercury type was used, and proved very good, since the current drawn is so small and the life of the battery is almost shelf-life. Another advantage of this type of cell is that the outer case is positive, enabling the main metalwork of the meter movement to be used as a common "earth" point, the cap only being

COMPONENTS FOR Fig. 4

- R1—220 K Ω
- R2—680 K Ω
- R3—2.2 K Ω
- R4—500 K Ω variable.
- R5—220 Ω .
- C1—25 μ F 25 v.wg.
- C2—0.01 μ F 350 v.w.
- C3—25 μ F 25 v.wg.
- T1—Mic. Trans. 150 : 1.
- T2—Output Trans. 6V6 to 3 Ω .
- V1—EF 37A.
- V2—6V6.
- V3—OCP 71.
- Carbon Mic. 7.5 v. bulb.
- DPDT switch. 6 v. and 7.5 v. batteries.

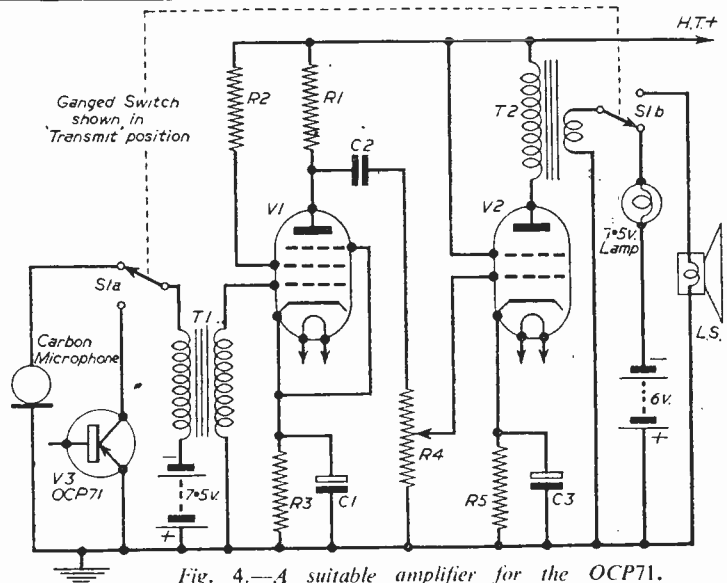

Fig. 4.—A suitable amplifier for the OCP71.

negative. The meter used was a fairly good quality type of sensitivity, 0-1mA.

As the dark current is so low, a switch was not found to be necessary. If, however, one is required, it may be wired in, in the normal way.

Second Circuit

Another use to which the photo-transistor may be put is the operation of a small relay. The photo-transistor is connected in series with a sen-

circuit as this have been enumerated in previous articles on the ordinary P.E.C., such devices as garage door openers, burglar alarms (a blue filter in front of the exciter lamp renders the beam almost invisible), liquid level controls, or even, with the relay adjusted and the sensitivity control very carefully set, as a smoke detector and fire indicator. In the original model the sensitivity control was found to be useful for experimental purposes. It may be dispensed with if desired.

Since quite a high degree of illumination is required by the cell, a simple lens system was

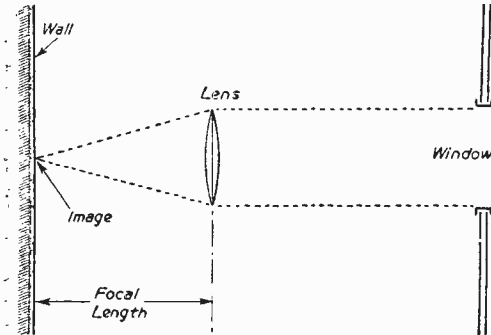

Fig. 3.—Finding the focal length.

sitive relay of about 3,000 ohms resistance, to a 9 volt battery. The relay must be sufficiently sensitive to close on about 2mA across a 9 volt supply. The one used in the prototype was a small ex Government relay P. 27258 which, after a little adjustment, closed on about 1½mA. The OCP 71 is employed in rather conservative circuitry for two reasons; it helps to avoid failures due to overheating when the cell is continually illuminated; second, for reasons of back EMF. When the photo-transistor is illuminated, a current of about 2mA is flowing through the relay coil. As soon as the illumination ceases the current drops to about 200µA. This causes a collapse in the magnetic field in the relay coil. This results in a "back-kick" of opposite polarity to that previously applied. This may be fairly large, of the order of 30 volts. Much of this is taken up in the relay coil itself, but some may appear in the circuit, which, unless a small "H.T." is used, may do damage to the photo-transistor. In order to reduce this back EMF an optional crystal diode may be connected, as shown.

The uses of such a

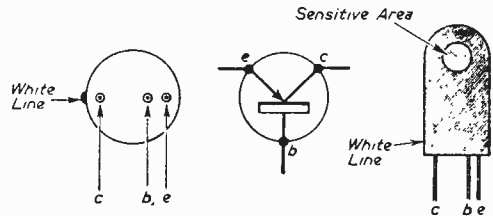

Fig. 6.—Connections of the OCP71.

found to be necessary. The system was not elaborate. A very scratched and battered lens was discovered. The focal length of the lens was found by focusing an image of a window on an opposite wall, see Fig. 3. The lens was mounted in a box which had been blackened inside, and the photo-cell mounted at the focus, this very simple arrangement was found to be excellent for the purpose. If a small arrangement is required the lens should be of short focal length. It must be remembered that with these lens systems it is inadvisable to direct the assembly at very high sources of luminous intensity, such as the sun, as the photo-transistor may become damaged. It might be worth mentioning that if an electric light bulb is held too near to the cell damage might result due to the heating effect of the lamp raising the temperature of the junction

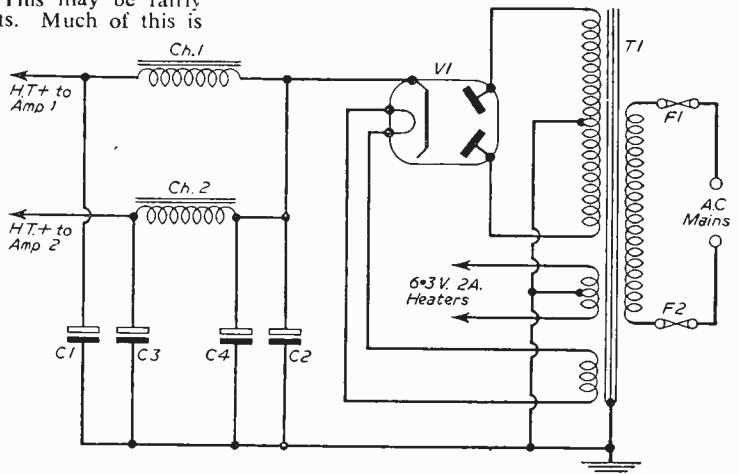

Fig. 5.—A power pack for the amplifier in Fig. 4.

- COMPONENTS FOR Fig. 5**
 T1—250-0-250 volts at 120 mA.; 6.3 volts at 2 amps.
 C.T.; 5 volts at 2 amps.
 Ch. 1 and 2—10H choke at 60 mA.
 C1 and C3—16 µF 350 v. wkg.
 C2 and C4—8 µF 450 v. wkg.
 V1—574.
 F1 and F2—500 mA. fuses.

causing a "run away," irreparably damaging the photo-transistor. When soldering these cells in circuit the normal precautions should be observed to prevent damage by heat. (A very efficient heat shunt has been devised by one firm. It consists of a slice of potato about $\frac{1}{4}$ in. thick, through which the wires are pushed and then soldered into circuit.)

COMPONENTS FOR FIG. 2

- 1—OCP 71.
- 1—Relay of about 3,000 Ω .
- 1—Variable resistor about 500 Ω .
- 1—9 volt battery.
- 1—OA 71 diode optional.

So far we have confined our activities to some simple projects, using the photo-transistor. The device about to be described has been used as a model demonstrating the underlying principles of radio communication and is a little more ambitious.

A Light Transmitter

The principles of operation are simple. A small pea-bulb is fed with current modulated with current fed from a small A.F. amplifier. The varying light from the lamp is transmitted by a suitable lens arrangement and passed on to the photo-cell. The photo-transistor converts the varying light into electrical pulses which is fed into another A.F. amplifier.

The range of the system depends, of course, upon the power of the lamp, and the lens efficiency. The larger the lamp the greater the modulating power, the lower the fidelity, due to

the thermal inertia of the filament. The range attained in a fairly carefully set-up arrangement was a little over 350ft. The system is a very long way from Hi-Fi, but is sufficient for the transmission of speech.

In the transmitting position the output from the amplifier is applied via the output transformer to a bulb and battery wired in series. The A.C. fed from the transformer varies the light output from the bulb in sympathy with the output from the microphone, and this may be regarded as "modulated light." The circuit is quite conventional as far as the rest of the circuitry is concerned. The original circuit was a "one way only" system, but as can be seen from the diagram, the system has been modified for two-way communication.

The photo-transistor is contained in a light-proof box to prevent "jamming" from sources such as 50 c.p.s. mains lighting. D.C. mains should not affect the system. The power pack was built on a separate chassis and was used to feed both amplifiers (two amplifiers of the type shown in Fig. 4 are needed).

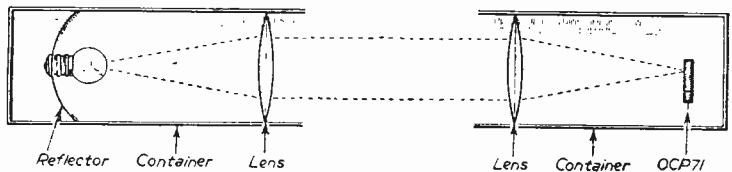

Fig. 7.—Details of a condenser lens.

A battery version of the circuit has been tried, but it was found to be very inferior to the mains model. For a long distance operation a condenser lens is required. A suitable arrangement is shown in Fig. 6. In Fig. 5 we give a circuit for a suitable power supply.

Experimental Standard Frequencies

AN experimental 60kc/s standard frequency broadcast, begun on July 1, 1956, at the Boulder (Colorado) Laboratories of the National Bureau of Standards, is opening up several interesting applications, some of which are already in use. A. H. Morgan, Chief of the Radio Broadcast Service Section of the NBS Radio Standards Laboratory, is supervising the experiment.

The Bureau has been broadcasting standard frequencies since 1923, when radio was in its infancy and very few people owned radio receivers. Through the years higher power and more frequencies have been added until at present the NBS standard frequency broadcasts are on six high frequencies (2.5, 5, 10, 15, 20, and 25 Mc/s) at WWV, Beltsville, Maryland; and on three (5, 10, and 15 Mc/s) at WWVH, Maui, Territory of Hawaii. Up to 10 kilowatts are radiated on some of the frequencies. Specialised radio receivers for these broadcasts have been commercially available for many years.

Measurements by the Boulder Laboratories and others have revealed that the regular standard broadcasts at high frequency (H.F.) are subject

to changes in frequency as they travel away from the transmitting aerial. This is sufficient to make these H.F. broadcasts unsuitable for many applications.

To meet this urgent situation, W. D. George, Acting Chief, Radio Standards Laboratory, initiated a plan to begin the experimental broadcasts at several low or very low frequencies. The 60kc/s frequency is being put into use first under the call sign KK2XE1.

The principal reason for studying standard frequency broadcasts at frequencies below about 100kc/s is to determine a practical method whereby the radio propagation errors are minimised and users may accomplish high-accuracy frequency comparisons in a shorter measurement time.

The experimental broadcast on 60kc/s, although on low power, has already presented several intriguing possibilities. With the co-operation of Professor Pierce, it has been possible to compare the NBS primary frequency standard, broadcast on 60kc/s, with the British standard, which is broadcast on 16kc/s and 60kc/s, to an accuracy of comparison which is better than two parts in one billion. This has been done almost continuously since the broadcasts began last July.

A BEGINNER'S CONSTRUCTIONAL COURSE

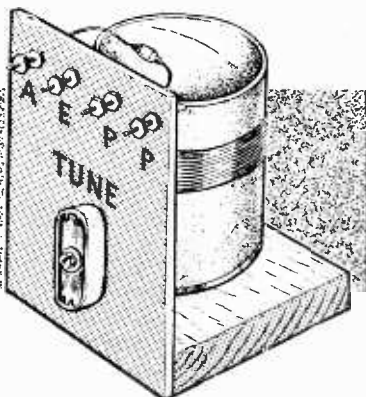

AS DISTINCT FROM A THEORETICAL COURSE, THIS SERIES STARTED WITH A SIMPLE CRYSTAL SET, WHICH IS GRADUALLY MODIFIED IN STAGES, UNTIL IT BECOMES A CRYSTAL AND TWO TRANSISTOR LOUDSPEAKER SET

By E. V. King

(Continued from page 604, November issue.)

Improving the Selectivity

YOU are now ready to make the receiver more selective. To do this, remove all leads soldered to the aerial tag. Fix another trimmer of about 500pF value above the other one. Fix one tag of the new trimmer (C1) to the aerial tag, remembering to solder all shims together on some types of trimmer. The other tag of C1 takes the leads which previously went to the aerial tag, i.e., one to the diode, one to the other trimmer C2, and one to the lead M of the coil (Figs. 17 and 18).

The trimmer C1 now becomes a variable selectivity control and C2 remains the tuning control. Naturally you may fit larger variable condensers with knobs if you wish, but the cost will be greater, the performance the same.

You will have to find by trial and error the best position for C1; as the selectivity improves the volume will drop. While this is a simple crystal set this is very important, but when a transistor is added selectivity becomes paramount as ample volume is readily available. Performance will be greatly improved on adding a transistor and volume con-

trol and modifying the coil to cover long waves as well as medium.

No doubt the experiments which have so far been given proved interesting and instructive as well as having given you much confidence. If you have not made up this radio you can easily do so now; if you are a real beginner do so only in stages and test each first.

It is assumed that you now have the simple radio working and that it is fitted with the aerial series condenser which has been mentioned. The front panel thus holds two trimmers (or variable condensers) and four terminals.

- PARTS REQUIRED**
(For the modifications given this month).
VR1—30 K or 50 K volume control.
Tr1—Red spot or OC71 transistor.
1 oz. 32 g. enam. copper wire.
S1, S2—2 toggle switches.
R1—1 220 K $\frac{1}{2}$ w. resistor.
R2—1 30 K or 33 K $\frac{1}{2}$ w. resistor.
One 500 pF Trimmer
1 T5 torch battery.

How to Modify the Coil to Receive Long Waves

In order to receive Droitwich and other Long Wave stations you must remove the coil and wind on another 120 turns of

32 s.w.g. enamelled copper wire in three piles of 40 wound in the same direction as the original 24 turns (Fig. 19). Each group of 40 turns is wound in a space of $\frac{1}{4}$ in. in a

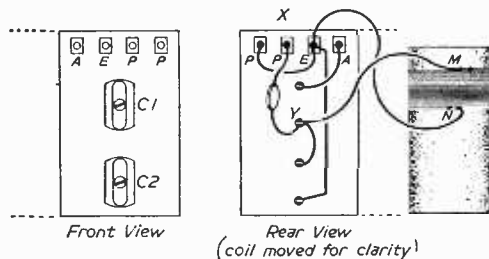

Fig. 17.—Practical wiring for the Fig. 18 circuit.

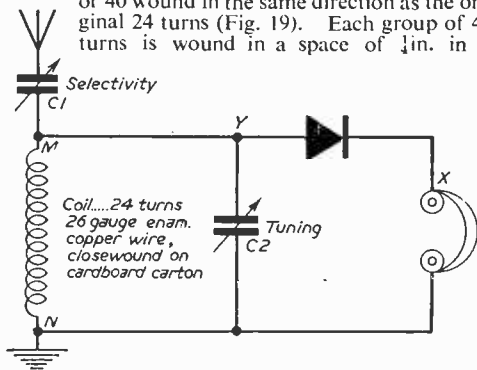

Fig. 18.—The modified circuit for improved selectivity.

pile and not side by side. The top of the new winding is carefully scraped and soldered to the bottom (N) of the old winding. There are now three connections to the coil, M, N and O.

The coil is now fixed back on the base and a wave-change switch is fixed to the front panel.

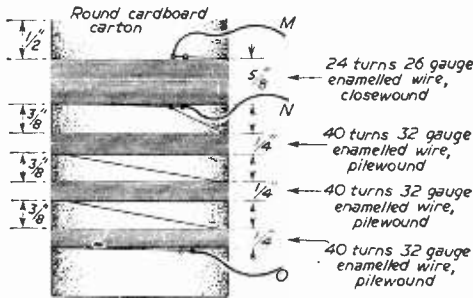

Fig. 19.—Modifying the coil for Long Waves.

and balanced-armature phones. The author received the Home programme in Surrey with such strength that a person ten yards from the phones could clearly hear speech or music! The Mullard OC71 is suitable, but the author used a 10s. Red Spot.

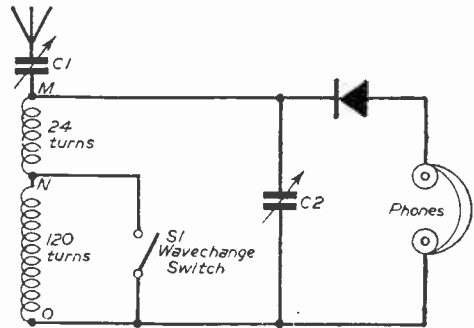
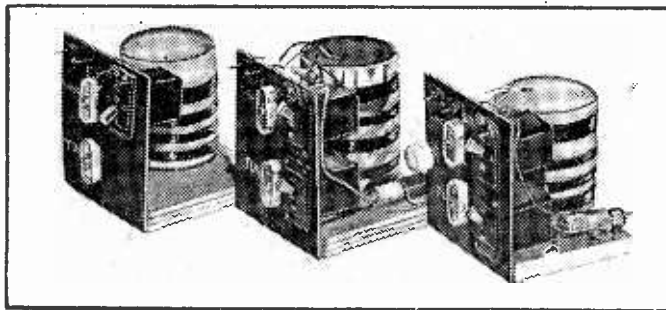

Fig. 20.—Theoretical circuit for dual range reception.

Any type of on/off switch will do. The writer had some rather large Air Ministry ones which he used. The switch position is shown in Fig. 21.

The wiring is completed (see Figs. 20 and 21b).

The "O" lead goes to the earthed tag of C2. The "M" lead goes to its previous position on C1. Lead "N" goes to one side of the switch, the other side going to the earth tag.



The three stages covered in this article.

Testing on Long Waves

Put the switch on (Medium Wave) and connect up phones, aerial and earth. The set should function just as it did before because the switch is shorting out the new long-wave winding. Now open the switch and do up C1 fairly tightly, then tune with C2. You will easily locate Droitwich, the author found that the Light Programme was better received on this band. Many Continental stations can also be received too, but some difficulty is experienced in separating them adequately.

How to Fit a Transistor for Much Greater Volume

Later, when a transistor is added, C1 can be loosened off and the selectivity thus improved. If you are using a very short aerial (i.e., a bedstead) and you have sufficient experience you could arrange to short out C1 when S1 is in the "off" position (Long Waves).

With one transistor fitted,

Power is drawn via another switch from a T5 torch battery which is fixed to the base behind the coil with a small tinplate clip (Fig. 24b).

The on/off switch, which may be of any type, is mounted underneath the wavechange switch (see Fig. 23). In future you will have to switch this one off when the set is not required or there will be a continual drain from the small battery. The current is, however, extremely small at about .1 or .2 mA according to the transistor used. The battery will last very many months.

Wiring the Transistor Circuit

Here is a suggested plan for the beginner to follow with the help of the theoretical and practical circuits of Figs. 24a and 22. Connect the earthy side of C2 to the newly fitted switch (S2). switch it off and connect the other side to the

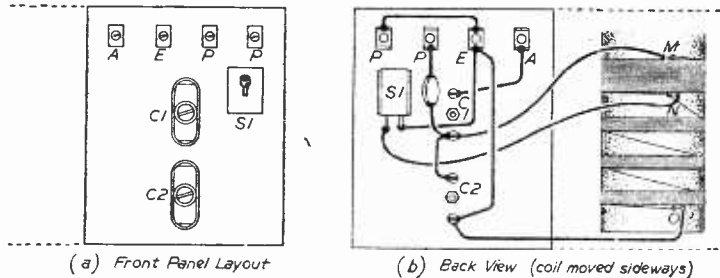

Fig. 21.—Practical wiring for Fig. 20.

brass cap (plus) of the T5 cell. Take a 33,000 ohm resistor and another of 220,000 ohms, shorten the leads to 1in. and join one lead of each together and take the spare 220k lead to the far phone tag and then to the

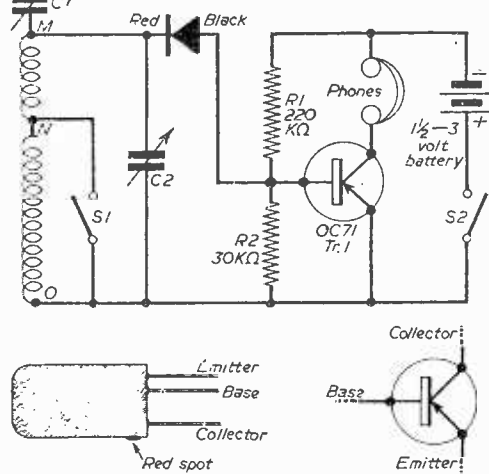
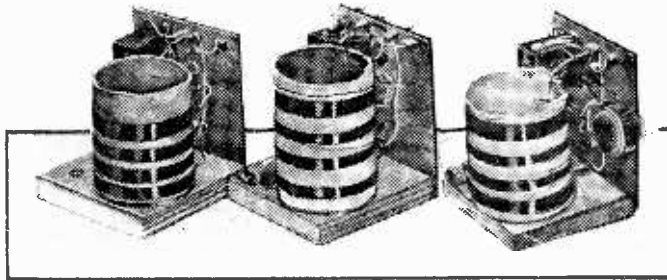

Fig. 22.—The theoretical one-transistor circuit.

negative side of the T5 cell. Join the spare 33k lead to the earth tag. The resistors are now freely suspended in the wiring with a solder blob where they join. The wire which previously joined one phone terminal to earth is removed. The diode is now unsoldered from the phone tag and is reconnected to the solder blob at junction R1 and R2. Make



Rear view of the units shown on the opposite page.

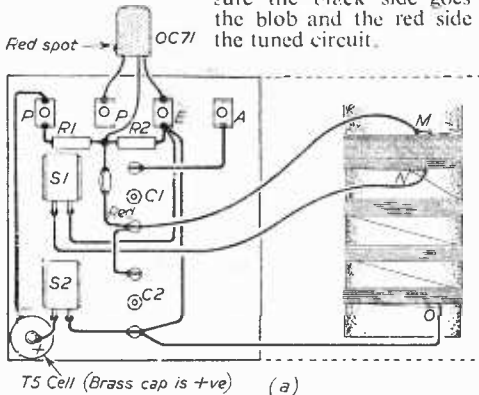

Fig. 24.—Rear view of the one-transistor receiver.

Now take the transistor and study it carefully with reference to the plans of Fig. 22. Leave the leads full length and slip some sleeving over them for protection against shorts. When soldering transistors you should always tin the parts they are to be fixed to, apply fluxite to the leads. Then take up some solder on the iron and quickly solder each lead in position. Do not let the hot iron warm up the body of the transistor, and if by any chance the soldering is not successful wait five minutes before having another go. The

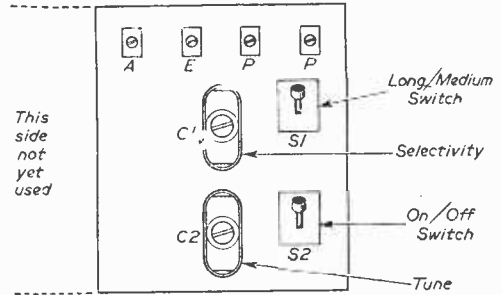

Fig. 23.—Front of panel layout for the one-transistor receiver.

writer is convinced that no special technique is really required in soldering transistors provided the operation is done quickly; he has had only one develop a fault in fixing out of hundreds which he has used. The beginner may like to play safe and make the sleeves on the short side so that he may hold each transistor lead with pointed pliers while it is soldered. This will take the

heat away and is known as a thermal shunt. Solder the collector (this is near the red spot) directly to the spare phone terminal tag where the diode used to be. The base (the centre lead) to the solder blob at junction R1 and R2, and the emitter (remote from the red spot) to the earth tag. The transistor is now freely suspended in the wiring, tuck it underneath but do not bend leads close to the body itself.

Check very carefully that you have wired up correctly; especially note that the battery is fixed the right way round.

Testing the Transistor Receiver

Connect up aerial, earth and phones and switch

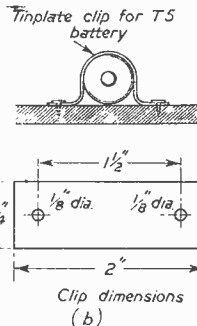

on S2. The receiver will now work with really super volume and clarity. You will find that you can, if you wish, receive local stations on quite short lengths of aerial and scores of Continental ones with a good long one. If you have a milli-

are taken respectively to the earth tag and the solder blob. R2 is now removed, for the volume control has taken its place. The circuit should now look like Fig. 25 except that the coil would actually hide the switches and trimmers. A

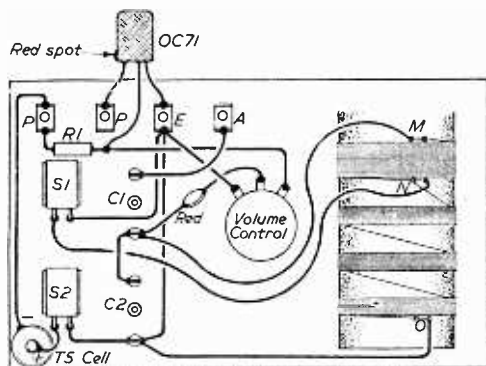

Fig. 25.—Rear view showing volume control.

ammeter you may check the transistor drain on the battery by fixing it in one of the leads to the battery

Fitting a Volume Control

Although the above set is now highly satisfactory you will appreciate the need for a volume control unless you put the phones underneath your pillow! (This is, by the way, a handy way of listening when in bed.)

The control, which is an ordinary 30k (50k will do) potentiometer and is fitted on the panel, the back view of which is shown in Fig. 25. The control should be just about under the aerial terminal.

The diode is disconnected from the solder blob and is connected to the slider (centre) of volume control. The remaining tags of the volume control

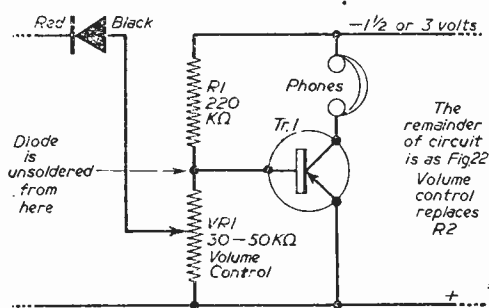

Fig. 26.—The circuit modified for use with volume control.

theoretical picture of the part of the circuit which is altered is shown in Fig. 26.

You may, if you wish, shunt the 50k volume control with a 100k resistor, the real value will then be 30k, but the author found very little difference in performance. If your control works the wrong way round simply reverse the connections to the outside tags.

The radio as it now stands will make a splendid standby receiver, bedroom, or camper's radio, if it is fitted in a wooden cabinet. The receiver is everlasting and the cell will last almost as long as it would on a shelf! You may, of course, fit normal condensers with knobs as previously stated.

Next month details will be given of fitting another transistor so that a loudspeaker may be worked at good volume.

(To be continued)

New Design of Radial Transducer

THE L.276, a new type of ultrasonic cleaning bath for small components and precision piece parts, is announced by Mullard Ltd. as being in full production.

The company's considerable experience in the development and application of ultrasonic techniques has shown a specific need for a compact, hand-fed cleaning bath to supplement conveyors equipment for the rapid and effective cleaning of small articles. Much of the design of this new bath is directly related to extensive field investigations undertaken to determine the precise requirements of many industries.

Ultrasonic Techniques

Although their history is relatively short, ultrasonic cleaning techniques have proved highly successful in all those industries where they have been adopted. In many cases, almost spectacular improvements in cleaning standards, with material reduction in processing times, have been achieved over conventional methods.

With the introduction of the L.276 even greater possibilities for the treatment of small components and precision piece parts are opened up.

New Design

The outstanding performance of the L.276 is attributable largely to a new design of low-frequency radial transducer, developed specifically for the equipment. This transducer has two important advantages, both of which result in improved cleaning efficiency and shorter processing times. First, it effectively focuses the cavitation intensity in the centre of the cleaning fluid container, where the component would be situated. Second, the cavitation effect is directed equally to all sides of the component simultaneously; therefore, unless exceptional requirements call for multi-stage processing, the entire surface area of the article can be cleaned with one dip.

The beaker is easily removable—it simply stands in position in the centre of the transducer annulus; multi-stage processing with a variety of cleaning agents when exceptionally high cleanliness is required can therefore be carried out by simple substitution of beakers.

The radial transducer incorporated in the L.276 is a low-frequency type operating at 20 kc/s. The choice of frequency (low as opposed to high) is dictated largely by the nature of the contaminations which the cleaning bath is intended to deal with.

Making a COIL & TRANSFORMER WINDER

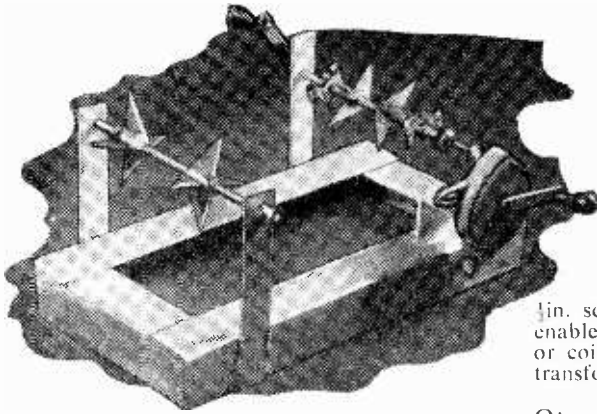

THE CONSTRUCTION OF HOME-MADE COILS, ETC., IS GREATLY SIMPLIFIED IF YOU HAVE A WINDING MACHINE SUCH AS THIS

By K. H. Parkes

1 in. sq. in. It will be seen that this flexibility enables almost any type of transformer bobbin or coil former to be wound, except, of course, transformers over $\frac{1}{2}$ kilowatt or thereabouts.

Operating Mechanism

The coil winding mechanism consists of a small grinding machine giving a turns ratio of 8 to 1. This grinding machine was obtained from the popular stores and should present no difficulty regarding purchase.

To fix this on the stand a small piece of angle iron was welded on, but a bracket of 16 s.w.g. iron can be bolted to the side serving the same purpose. A large brass nut is soldered on the $\frac{1}{2}$ in. spindle to screw on to the grinding machine, which is provided with a locknut. The other end of the driving spindle is filed square, as in Fig. 5, and tapped centrally 4 BA. A small handle is made

MOST constructors have tried winding their own coils and transformers, and the usual arrangement consists of a drill fixed in a vice and the cutting of wooden blocks to fit various formers and bobbins. The writer tackled a few filament transformers in this way but soon realised that some kind of machine was essential if transformer construction was to be carried out with any rapidity.

After trying and rejecting various methods and consulting one or two "old hands" about this phase of radio construction, the following machine was evolved. The materials used were odds and ends found in the spares box, and the few additional items should not cost more than fifteen or sixteen shillings.

The base shown in Fig. 1 consists of four pieces of angle iron, welded or bolted to form a skeleton-type chassis. The size can be varied, but in the original $1\frac{1}{2}$ in. angle iron was used, two pieces 14 in. long and two pieces 7 $\frac{1}{2}$ in. long. Three uprights of 16 s.w.g. mild steel are bolted on to form bearings for the spindles. Uprights are 6 in. long by 1 in. wide, drilled $\frac{1}{2}$ in. hole for shaft. The spindles are two lengths of $\frac{1}{2}$ in. rod, originally extension shafts for potentiometers. The rear one taking the bobbin of wire is 9 in. long and the winding spindle 7 $\frac{1}{2}$ in. long. Four brass bushes 1 $\frac{1}{2}$ in. long by $\frac{1}{2}$ in. thick drilled centrally with a $\frac{1}{2}$ in. hole are required for clamping the bobbins centrally around the spindles. These bushes could be brass spindle couplers. Each bush is given four saw cuts lengthwise to accommodate the brass vanes. Sixteen brass vanes are required in the shape of right-angled triangles, as in Fig. 3. These can be cut out of old brass condenser vanes. A hole is drilled in each bush in one of the spaces between the saw cuts and tapped 4 BA to take a grub screw. When this is done the vanes are carefully inserted in the slots and sweated in with solder. These chucks are self centring and will take any bobbin or former, round or square or oblong up to a maximum size of 4 sq. in. core dia. or a minimum of

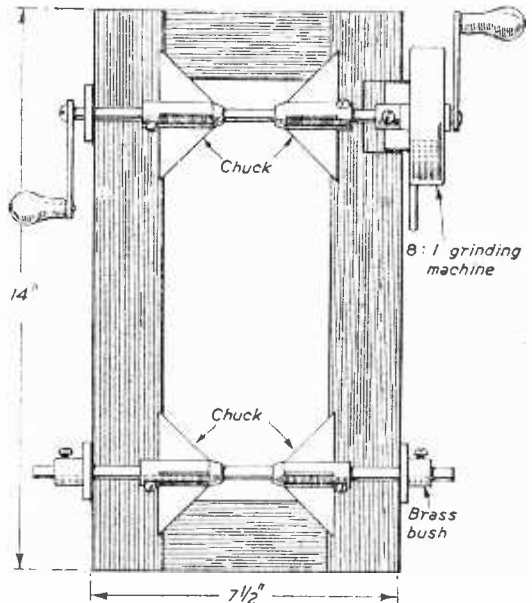

Fig. 1.—Details of the coil winder.

from a length of 16 s.w.g. strip $3\text{ in.} \times \frac{1}{2}\text{ in.}$, and using a square file a $\frac{3}{16}\text{ in.}$ hole at one end is filed square to fit the shaft. A short piece of 4 BA studding at the other end provides the

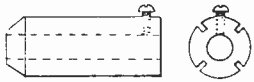

Fig. 2.—The boss which carries the chuck fins.

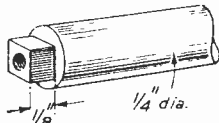

Fig. 5.—(Above) The boss which carries the handle, and Fig. 3 (right) details of the fins.

handle. When winding fairly heavy L.T. windings this handle is fixed on with a 4 BA bolt and enables the turns to be laid slowly and tightly.

On each end of the wire-carrying spindle two brass bushes taken from tuning knobs are fixed to prevent the spindle coming out of the upright bearings. These also serve as tension devices, due to the springiness of the uprights.

No provision has been made for counting turns, but a small rev. counter could no doubt be attached to the upright on the driving end.

Now that transformer construction can be undertaken with reasonable speed and confidence, it is surprising to find what materials are readily

obtainable. High cycle transformer laminations can be used. Field coils and relay bobbins provide a source of wire. Cardboard for bobbins, waxed paper from condensers, can be pressed into service.

Setting Up

A final word on how to set up the winder. Take a reel, bobbin or old transformer core containing the wire, slip off one brass bush and chuck, slide the bobbin on, replace chuck, tighten up, and replace brass bushes. Undo the small grinding machine slide off one chuck and fit bobbin or core to be wound. Tighten up chuck, replace grinder, and the machine is ready.

The usual precautions regarding transformer winding should be observed, i.e., insulation, dropped turns, etc.

Practice proves that this machine is very versatile and should more than pay for itself in next to no time.

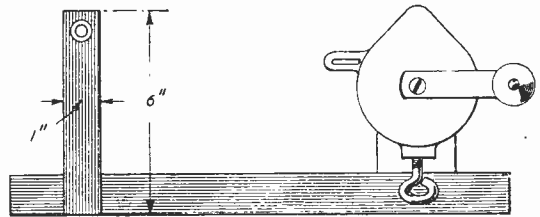

Fig. 4.—Side view of the winder.

News from the Clubs

THE NOTTINGHAM AMATEUR RADIO CLUB (G3EKW)
Hon. Sec.: F. V. Farnsworth, 32, Harrow Road, West Bridgford, Nottingham.

The club meets every Tuesday and Thursday at Woodthorpe House, Mansfield Road, 7.15 to 10 p.m., for practical construction work, noise training under expert tuition with latest equipment, lectures and discussions. The Club transmits on top band and after some reconstruction work hopes to be on other bands as well. Prospective members are very welcome to visit the club.

THE BURY RADIO SOCIETY

Hon. Sec.: Mr. C. L. Robinson, 56, Avondale Avenue, Bury.
MEETINGS of the above society are held on the second Tuesday of the month at the George Hotel, Kay Gardens, Bury, at 8 p.m.

Forthcoming meetings are:
November 12th. Mr. T. C. Platt (G2GA)—"An Old Timer Looks Back."
December 10th. A.G.M. and Junk Sale.

THE SLADE RADIO SOCIETY

Hon. Sec.: Mr. C. N. Smart, 110, Woolmore Road, Erdington, Birmingham, 23.

The club station (G3JBN) at the Church House is available every day of the week for the use of members. Instructional and constructional classes are held on every Tuesday and Wednesday evening. Extra Morse classes will be held on Monday evenings when the demand is sufficient. The "Slade Net" will be on the air on the following Friday evenings: November 29th; December 27th.

November 8th. "Astronomy and Cosmology," by the Astronomer Royal, and "Interplanetary Travel," by W. A. Scarr, M.A., (G2WS). Two recorded tape lectures from the R.S.G.B. Library; plus recordings of transmissions from G3BSP.

November 22nd. Annual General Meeting.
December 6th. "Air Traffic Control." A talk by an air traffic control officer from Birmingham (Elmdon) Airport.

December 20th. "Fun and Games," presented by Messrs. L. H. Blackwell and G. L. Turner (members).

SPEN VALLEY & DISTRICT RADIO & TELEVISION SOCIETY

Hon. Sec.: N. Pride, 100, Raikes Lane, Birstall, nr. Leeds.
The above club has altered its title to "Spenn Valley Amateur Radio Society."

The officials for the year are: president, J. Charlesworth (G3JJC); vice-president and hon. treasurer, Mr. I. A. Metcalfe; committee, Messrs. F. Varley (G2FCP), G. Crossley (G2CGR), and J. J. Rose.

The meetings for November are:
Wednesday, November 13th: Supper at George Hotel, Cleckheaton.

Tuesday, November 26th: A joint meeting with the Bradford Radio Society at Bradford Technical College by E. M. Price, M.Sc., on "Some Experiments with Microwaves."

Thursday, December 5th: Joint meeting with Leeds University Union Amateur Radio Society at Leeds University Union, when Messrs. Eddystone will lecture on Communication Receivers.

LIVERPOOL & DISTRICT AMATEUR RADIO SOCIETY

Hon. Sec.: Mr. W. D. Wardle (G3EWZ), 16, Mendip Road, Liverpool, 15.

AUTUMN programme is as follows:

November 5th—Debate,
November 12th—Films,
November 19th—Open Night,
November 26th—Construction Contest,
December 3rd—Junk Sale,
December 10th—Police Radio.

Meetings are every Tuesday at the Community Centre, Penny Lane, Liverpool, 15.

The Society are very keen to get more young members and SWLs. The Annual General Meeting was held on October 1st when Mr. Basil O'Brien, R.S.G.B. Regional representative, presented the Society with both the Region 1 Trophy and the Trophy for the highest score in National Field Day. This is the first time both have been won by the same Society in any one year.

SIGNAL GENERATOR

Coverage 120 kc.s. 84 Mc.s. Metal case 10in. x 6in. x 4in. Size of scale, 6in. x 3in. 2 valves and rectifier. A.C. mains 230-250 v. Internal modulation of 100 c.p.s. to a depth of 30 per cent., modulated or unmodulated R.F. output continuous variable 100 milli-volts. C.W. and mod. switch, variable A.F. output and moving coil output meter. Grey hammer finished case and white panel. Accuracy plus or minus 2%. £4 19 6 or 34 - deposit and 3 in thly payments 25 - P. & P. 4 6 extra.

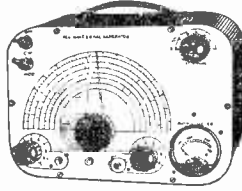

COMMERCIAL TELEVISION CONVERTER SUITABLE FOR ANY T.V. (except P.A.P.P.) WITHIN 35 MILES OF I.T.A. TRANSMITTER. ALL CHANNELS NO ALTERATIONS TO SET.

Complete with built-in power supply 230-250 v. A.C. mains. Crackle finish case 5 1/2 in. long, 3 1/2 in. wide, 4 1/2 in. high, incorporating gain control and band switch. Illus. with cover removed. **£3.19.6** Plus P. & P. 2s. Hire purchase available. 3 element folded dipole I.T.A. LOFT AERIAL 15/- P. & P. 2/- Coax cable 8d. yd.

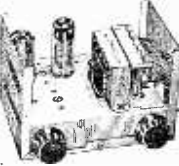

AC/DC MULTI-METER KIT

Comprising 2in. moving coil meter, scale calibrated in A.C. D.C. volts, ohms and milli-amps. Voltage range AC DC 0-10, 0-100 and 0-500, Milli-amps 0-10, 0-100. Ohms 0-1,000 and 0-10,000. Front panel, range switch, wire-wound pot (for ohms zero setting), two toggle switches, resistors and meter rectifier. In grey hammer-finish case

19/6 Plus P. & P. 1s. 6d.

Point to point wiring diagram 1 - free with kit.

4 VALVE ALL-DRY SUPERHET PORTABLE KIT

Incorporating Ferrite rod aerial Medium and long waves. In grey leatherette. Size 9in. x 7in. x 6in. Valve line-up: 1T4, 1R5, 1S5, 3V4. Complete kit of parts (less batteries).

£5.19.6 Plus. Post & Packing 3s 6d



COMPLETELY BUILT PORTABLE AMPLIFIER

approx. size 6in. x 2 1/2in., incorporating 2 valves, contact-cooled metal rectifier, bass and treble lift controls **39/6** Plus and double wound mains transformer 230-250 v. P. & P. 3s 6d 5" P.M. SPEAKER & O.P. TRANSFORMER, if purchased with the above, 18/6. Plus P. & P. 1s 6d.

COLLAR 4-SPEED AUTOMATIC CHANGER

Model 456 (suitable for use with above amplifier). A.C. mains. 200-250 v. turnover crystal head. Brand new, fully guaranteed. **£8.19.6** Plus or £3 deposit, plus P. & P. 5/- and 6 monthly payments of £1-4-0.

T.R.F. KIT IN PLASTIC CABINET

3 valve plus metal rectifier. A.C. mains 200-250 v. Medium and Long waves. In pastel blue or brown. Valve line-up: 2 VR60s and VT52. Size 15 1/2 in. long by 9in. high by 7in. deep. **£3.19.6** P. & P. 7s 6d.

Point to point wiring diagram 1.6. Free with kit.

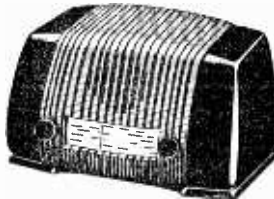

RADIO & T.V. COMPONENTS (Acton) LTD.

23 HIGH STREET, ACTON, LONDON, W.3
GOODS NOT DISPATCHED OUTSIDE U.K.

TRANSISTORS

JUNCTION TYPE P-N-P

(British Manufacture)

RED-SPOT 800 kc.s Audio Frequency.....	10/-
BLUE-SPOT 1.6 Mc.s Mixer and Frequency Changer.....	15/-
WHITE-SPOT 2.5 Mc.s R.F. and I.F. Amp.....	20/-

All Transistors are Tested and Guaranteed.

N.B. The Red Spot is similar to Mullard OC 71.

The New

"TRANSISTOR-8"

Push-Pull Portable Superhet Can be built for **£11/10/-**.

This Portable 3 Transistor Superhet is tunable for both Medium and Long Waves and is comparable in performance to any equivalent Commercial Transistor Set. Simplified construction enables this set to be built easily and quickly into an attractive lightweight cabinet supplied.

TEN STAR FEATURES

- ★ 3 Specially Selected Transistors
- ★ 250 Milliwatts Output Push-Pull
- ★ Medium and Long Waves
- ★ Internal Ferrite Rod Aerial
- ★ 1 x 4 Elliptical High Resistance Speaker
- ★ Drilled Plastic Chassis 8" x 2 1/2"
- ★ Point to Point wiring and practical layout.
- ★ Economical. Powered by 7 1/2 v. battery
- ★ Highly sensitive
- ★ Attractive lightweight contemporary case

N.B. Pair of Matched OC 72's or equiv. Supplied at additional cost of 40/-.

Call and hear demonstration model.

We can supply all these items including Cabinet for **£11 10/-** All parts sold separately.

Send for circuit diagrams, assembly data, illustrations and instructions, and full shopping list. **1/6.**

"EAVESDROPPER"

THREE TRANSISTOR POCKET RADIO (No Aerial or Earth required)

Variable Tuning. Total cost, as specified including Transistors, Transformers, Coils, Condensers and Battery, etc. with circuit and plastic case.

All items sold separately **77/6** POST FREE
With single phone. 82/6. With Acos Mike. 90/- With Min. Hearing Aid 92/6.

MINI-TWO

TWO-TRANSISTOR MINIATURE POCKET RADIO

The smallest Transistor set offered on the market. Variable Tuning. Drilled Chassis; Plastic Case size 3in. x 2in. x 7in., Miniature Hearing Aid. 2 Transistors and all components including 1 1/2 volt Battery. Circuits and full practical layout diagrams.

Total Cost **49/6** Complete

TRANSISTOR SIGNAL TRACER

Complete Kit with 2 Transistors. Components, Phones, with Circuit and plastic case. **42 6d.**

TRANSISTOR SQUARE WAVE GENERATOR

Complete Kit with 2 Transistors. Components, Circuit and plastic case. **25/-.**

QUARTZ CRYSTALS

5/- each
Send for Lists.

"HOMELIGHT" 2-TRANSISTOR PERSONAL PORTABLE

Variable Tuning
We can supply all components including 2 Transistors, Diods, Resistors, Condensers and Miniature Hearing Aid and Plastic Case size 4 1/2 x 2 1/2 x 1 1/2 in. and 1 1/2 v. Battery. **FOR 52/6**
All items sold separately.

6 v. VIBRATOR PACKS
Output 120 v. 40 mA., 12.6. Brand new.

R.F. 24, 10/- R.F. 25, 12.6.
R.F. 26 25/- Brand new with valves, carr. 2.6.

SEND STAMPS FOR NEW 1957 28-PAGE CATALOGUE OPEN MONDAY to SAT. 9-6. THURS. 1 o'clock.

HENRY'S RADIO LTD.

5 HARROW ROAD, EDGWARE ROAD, LONDON, W.2
TEL.: PADDINGTON 1008-9

TRANSISTORS *in Practice*

AN EXPERIMENTAL TRANSISTOR CHASSIS

By R. Hindle

(Continued from page 616 November issue)

It is important to remember that for the miniature battery portable for which purpose the transistor excels it will be as well to be satisfied with the 200mW. of power output that is easily available from commonly available transistors. A modern speaker of good efficiency can give a good account of itself on such an audio power. There is one application, however, that has, no doubt, sprung into the minds of readers. A car accumulator is quite happy with a drain in the order of amps. and the idea of avoiding the conversion of the battery voltage to a H.T. voltage by means of a vibrator should prove popular when transistors giving watts of power are available. It is hoped, in due course, to present such a design. But first of all some simple designs will be presented.

Transistors were first applied to audio amplification work for which, in view of the frequency limitations of the earlier models, they were particularly suited, and the constructor will be wise to try out such a circuit first to accustom himself to transistor conditions of operation. It seemed to the writer that something more than the usual form of completed design was called for in the present instance. The chassis here described was produced, therefore, as a basis for the experimental use of transistors. On this an audio circuit is first built, but from the beginning facilities are provided for developing a simple receiver in progressive steps.

The point was made in the preliminary explanation of transistor principles that these devices are very sensitive to temperature rise. Indeed, such a rise, whether due to operating conditions or to a source of heat applied externally, can destroy a transistor and consequently great care must be taken when doing constructional work, not to allow the heat from the soldering iron to damage them. It is not a pleasant prospect to think that transistors bought at their comparatively high present price should fail before they have even begun to give a good account of themselves. They can be soldered into the circuit and if care is taken no trouble will arise. This care amounts to the use of a heat shunt applied between the point of contact of the soldering iron and the transistor body to conduct the heat away. The method is identical with that adopted electrically when a low resistance shunt is put across a sensitive meter to conduct away the majority of the current and protect the meter. Quite simply, a pair of pliers forms a suitable shunt, so that all that need be done is to hold the transistor with the pliers gripping the connecting wire to be soldered—and of course nearer to the body of the transistor

than the point to receive the solder. Such a course is quite suitable when transistors are being soldered in for all time, but in the early days of transistor use there is a temptation to try out the components in different circuits. Continual soldering and unsoldering (particularly the latter—it always seems harder to take a component off than to wire it in) means exposing the device repeatedly to the risk of damage. This risk arises not only when the transistors themselves are being fixed or removed, but also when, say, a resistor adjacent to the transistor is being changed.

In the present case it was decided to avoid this risk by providing sockets for the transistors. This preserves the components for more permanent designs that will follow, using the same parts as the experimental first unit. The wires of the transistors were bent back on themselves about $\frac{3}{4}$ in. from the body. Holding each

Many readers experience difficulty in understanding how the modern transistor operates, and therefore this short series of articles has been prepared to explain their action—in theory and practice. This month we give an experimental transistor set.

such connecting wire in the jaws of the pliers as a heat shunt, in the manner previously described, solder was run on to the extremes of the wires to stiffen them. This was a once for all operation; the stiffened ends of the wires could then be plugged into

the sockets like valves (in fact miniature valve sockets were used for the purpose) and they could be withdrawn when modifications were being made to the chassis, or for incorporation in other devices. It is agreed that transistors used in this way do not look so elegant as when wired in, but at least they are preserved for subsequent use and, in fact, the leads are left long enough to be soldered in later when it is decided where they are to be put to permanent use. There is one word of warning about using transistors in this way. Care has to be taken to insert the wires in the correct sockets and not to force them in by means of the body of the transistor, for this may cause mechanical damage that would be just as bad as the electrical variety or, failing that, the wires that are very close together at the point of lead-out from the transistor may be pushed into contact. The safe procedure is to locate the wires in the top of the socket and then force home with a

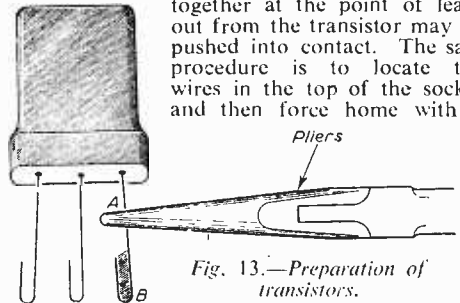

pair of fine-nosed pliers, gripping the wires at the top of the part that was stiffened by the solder. Fig. 13 indicates the technique, point A being the place to hold with the pliers whilst soldering the wires and when pressing them home into the sockets whilst, at point B where the wires are bent back, the solder is run in.

Facilities Provided

The audio amplifier that it is proposed to build on this chassis has two stages, both of low power. It can be used by itself in the early stages, and later it can feed a power output stage. A position for a third transistor is provided in readiness for the later stages in the development of the design and there is room for a fourth should this be required subsequently. No provision is made for the power stage on the present chassis. If the constructor wished he could make the chassis somewhat larger with this in view but it seems better to relegate this to a separate panel. The writer is experimenting with a somewhat different method of construction that seems particularly suited to transistor work when the first excitement of experimental work is over and a design is made up more permanently; the power stage is being made on these new lines and will attach to the present chassis if required.

In addition to the transistors themselves, some means for tuning is provided in readiness for the next stage. Until recently the transistors available in this country were not really suited for medium-wave work and some experimental receivers have been described working on long waves only. It seemed better, however, to await some genuine H.F. specimens and these now being to hand, medium waves can be operated without difficulty. Consequently there is every reason to provide tuning facilities and a miniature two-gang capacitor is built on to the chassis. The first tuner circuit on this chassis uses only a single section but the second section will be useful later on.

The Chassis

The chassis produced with this purpose in mind is not so small as a transistor design will allow but it is still quite small, whilst allowing sufficient room for alteration and experiment and leaving open access to components. After all, it is an experimental chassis. The particular dimensions were chosen because they happened to fit the small cabinet used for the Mini-four and Mini-amp designs appearing in PRACTICAL WIRELESS some time ago. The battery, and the power stage later to be described, stow away in the lower compartment and the speaker incorporated in the earlier designs can then be used for the transistor experiments. This cabinet is not necessary, however, and the chassis as described stands by itself.

Fig. 14 gives the dimensions of the chassis and the layout of the major components to be mounted upon it. It will be seen that there is provision for a second control in addition to the tuner. If desired, a switch could be mounted at this second control position to control the battery. The hole is used, in fact, in the next stage for a regeneration control and, as this is resistive, a volume control potentiometer is used. This naturally incorporates a switch and is actually a

25KΩ component. It is suggested, therefore, that the constructor should mount such a control at the outset and at this early stage use only the switch.

A place is also left on the chassis for a miniature transformer at the output position. The amplifier is likely to be used in the first instance with a pair of phones, which can be connected directly into the collector circuit but for alternative uses a transformer will be specified. The component allowed for is a miniature version produced by Belclere especially for transistor work at a very satisfactorily low price. The transistor being fundamentally a power producing rather than a voltage producing device, and therefore matching conditions being important for best efficiency, the provision of a transformer is desirable. As the input transistor characteristic demands current instead of voltage, the circuit feeding a power output transistor has to be looked upon as a driver stage, in the same sense that a driver stage is considered necessary before a class B valve stage in which grid current is allowed to flow. The present amplifier can be looked upon

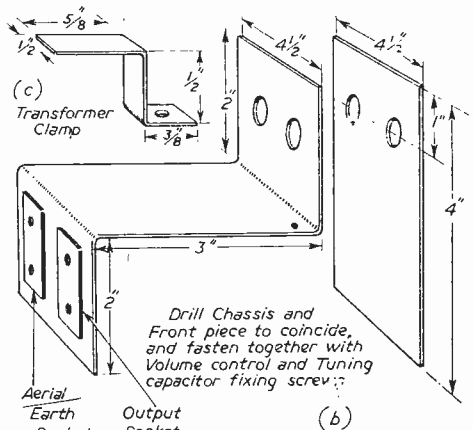
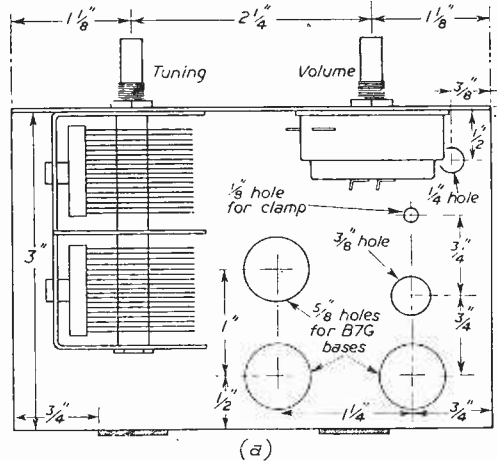

Fig. 14.—Aluminium chassis and layout. (Top of chassis.)

therefore, as a driver for the following circuit and the transformer will permit the transfer of maximum power. These miniature transformers have no mounting brackets. They can be held in place by the wiring, as will be seen in the permanent circuit versions planned, but for this experimental model the component is fixed by means of a small aluminium clamp which is also illustrated in Fig. 14. Both parts of the chassis are made of sheet aluminium.

Amplifier Circuit

The circuit used for the amplifier part of this design is given in Fig. 15. Both stages operate in the common emitter configuration as shown previously in Fig. 12, except that a transformer load is indicated for T2. The inter-stage coupling is by resistance/capacitance as previously described, and D.C. stabilisation by the preferred method is provided at both stages. A battery supply of

except that the bias is in the form of a current. There is an upper and a lower limit to the collector current excursion—an upper one set by the maximum dissipation permissible, as specified by the transistor manufacturer (audio transistors of the type used in this amplifier are rated at 50mW.) and this is governed by the permissible rise in junction temperature. In case the reader should be inclined to quibble about the rating given for the dissipation limit of 50mW., this is the upgraded limit now specified by Mullard for the OC71, which was previously rated at 25mW. Assuming .3 volts across the transistor (the remainder will be lost in the load and feedback resistors) this would seem to allow a working range of collector current up to about 15mA. The lower limit is set by the leakage current that passes even when there is no current at the input position. As this current flows at the collector without any current at the base, clearly

it is not subject to control by the base and consequently the base must swing with the input signal only over a range that will cause a collector current greater than this leakage current for the common base circuit is the only one specified by the makers in their literature, this being the current that flows through the diode formed by the collector and base by virtue of the fact that the resistance to a reversed voltage is not infinite, as we so often like to think it. The leakage current for common base connection is, in fact, quite small. For the common emitter circuit, however, as here used, this leakage current is subject to amplification of the order

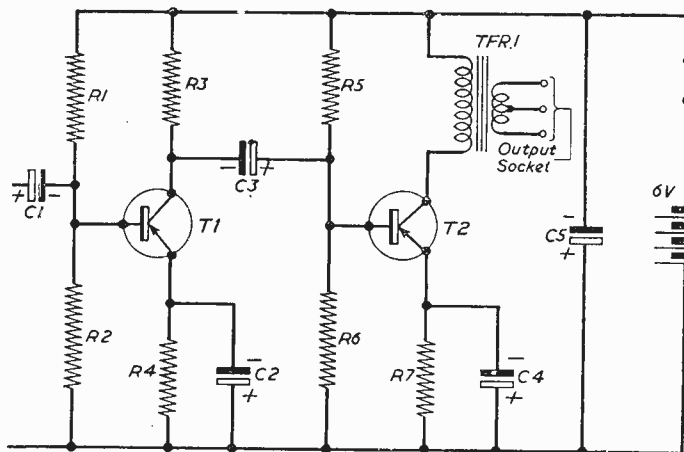

Fig. 15.—Circuit diagram of the amplifier described in this article.

6 volts is chosen, this being a convenient value giving economical working.

R4 is a D.C. feedback resistor for stabilisation purposes and is chosen to provide the degree of stabilisation required, having in mind the manufacturing spread and the likely variation in operating conditions. A voltage drop across the resistor of between ½ volt and 1½ volts is generally chosen for this purpose—it must not be too high or there will be insufficient voltage left to operate the transistor satisfactorily. The actual value depends on the emitter current flowing through it, and this current is practically the same as the collector current, the difference being accounted for by the base current.

What value of emitter and collector current has to be taken, then? In valve technique, it is well understood that a bias has to be applied to the grid so that the anode voltage can swing on either side of the quiescent voltage in conformity with the input signal, the excursions above and below the no-signal condition being equal for minimum distortion. Failure to apply such a bias results in distortion to the signal in the form of clipping of the positive half-cycles. The transistor also requires a bias at its base and for similar reasons,

of the current amplification factor (α^1) of the common emitter transistor and, under these conditions, is of the order of 150 μ A.

A range of between 150 μ A. and 15mA. leaves quite a choice. In the interests of economy, however, as low a current as is likely to be satis-

COMPONENT LIST FOR FIG 15.

R1—22K R2—4.7K R3—3.3K R4—1.8K } 1 watt
R5—12K R6—4.7K R7—470 Ω

C1, 2, 3, 4 10 μ F 6 volt Daly H2 5:1
C5 50 μ F 12 volt Daly E2 15:2

T1, 2 OC71 Mullard
TFR1 BN1826 Belclere Interstage.

ALSO REQUIRED :

- 1 chassis as described.
- 1 Two gang miniature tuning capacitor, 500pF Osmor.
- 1 Volume control 25K linear law with single pole switch.
- 3 Valve holders miniature 7 pin.
- 1 Tag strip, 1 plus earth.
- 2 Knobs.
- 1 6 volt battery.

factory will be adopted. There is an additional virtue in low consumption that is likely to be considered even more important. The transistor tends to introduce noise in proportion to collector current and so economy leads to better signal/noise ratio. One would expect to see, therefore, in cascaded transistor amplifiers, that each stage along the chain would have progressively more collector current as the signal was amplified and each stage was being driven by a greater signal current than its predecessor. The first stage is commonly designed around a current of $500\mu\text{A}$, which will permit a signal output of up to about the same figure peak to peak. Current gain being of the order of 50 times in the average case, the stage can be expected to accept an input signal of up to $10\mu\text{A}$, and the base current in the quiescent state, i.e., the bias to be provided, would be around $10\mu\text{A}$. This condition of working is used for the first stage of this amplifier.

Though the emitter current is equal to the collector current plus the base current, the latter is so small comparatively ($10\mu\text{A}$, compared with $500\mu\text{A}$) that its effect is negligible—after all, the normal resistor tolerance is more than the proportion of collector to base currents. So, to drop 1 volt across the emitter resistor with a current of $500\mu\text{A}$, the resistor should be $2\text{K}\Omega$. An easily available size must be chosen for R_4 , however, so $1.8\text{K}\Omega$ is specified.

The collector load resistor, R_3 , if one were to

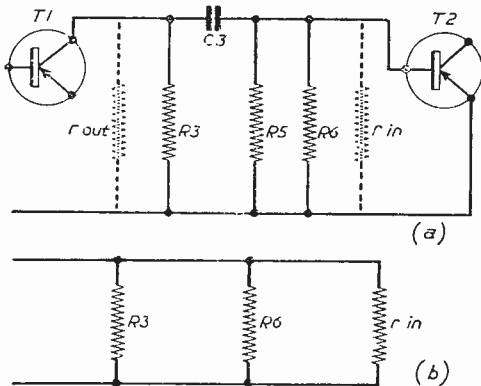

Fig. 16.—Circuits of the equivalent load on T1.

aim at taking off the maximum signal voltage, as in the case of a valve, would be made as high as possible. The aim, in the case of a transistor feeding a following transistor is, however, to pass on the maximum signal current to the second stage. Any signal current flowing through R_3 is, therefore, wasted because a current cannot flow through this and also through the next transistor base circuit when both are in parallel. The larger R_3 is made, the less will be the current that will flow through it in preference to taking the intended path to the next transistor base so, as in the case of the valve, the collector resistor should be as large as possible. From the point of view of D.C., however, this resistor is the only path from the battery to the collector, C_3 effectively blocking the alternative path to D.C. It

has already been decided that $500\mu\text{A}$, should flow to the collector. The battery supply is 6 volts and almost 1 volt has been taken up in the emitter resistor. A value of $10\text{K}\Omega$ at R_3 would mean that 5 volts would be dropped across it for a current of $500\mu\text{A}$, (by Ohms Law), leaving nothing for the transistor, which is obviously absurd. Therefore, R_3 must be less than $10\text{K}\Omega$.

The actual load on T1, from a signal point of view, is quite complex and is in the form given at Fig. 16(a), where the component identities are the same as in Fig. 15. If the value of C_3 is properly chosen so as to have negligible reactance at the frequencies to be operated it can be neglected for the present purpose and it will be seen shortly that R_5 is many times greater than R_6 , so consequently it is of little importance from the point of view of T1 load. The input resistance of T2 (i.e., r_{in}) is likely to be about $1\text{K}\Omega$. The output resistance of T1 (i.e., r_{out}) is high and consequently has little effect as a shunt. Thus the load given at Fig. 16(a) reduces to that given at Fig. 16(b), the aim being to put the maximum current through r_{in} . So long as R_3 is at least three times r_{in} it is not likely to affect the signal gain seriously and, on the other hand, is not so large as to starve T1 of volts and so R_3 is made $3.3\text{K}\Omega$. This, and the emitter resistor, leave about 2 volts across the transistor which is reasonable for the low level of signal expected at this stage.

Cheap Transistors

R_3 and R_4 thus account for about $4\text{K}\Omega$ in series with the transistor across 6 volts supply. Now if the whole of this voltage were to be dropped across these resistors only $1\frac{1}{2}\text{mA}$, could flow, so obviously no more current can pass when the transistor is also in series. This is well within the rating of the transistor, which is thus fully protected from damage by excessive current. It might be thought, therefore, that no D.C. stabilisation is really necessary. This would be quite true if the conditions for operation of the transistor were to be set in the first instance by means of a meter to suit the particular component used and if, when the transistor was changed, the setting up procedure were to be repeated. Stabilisation is introduced, however, to cover variations due to manufacturing spread and variations in normal operating temperatures. Cheap transistors are available from many sources; these are generally outside the spread quoted by manufacturers and results cannot be guaranteed in these cases. Users of such transistors could satisfy themselves that their operating conditions are not widely different from those quoted by measuring the collector current flowing. The safety of the transistor is ensured by the series resistors, so users without a suitable meter need not worry on that score. In all fairness, it should be stated that the amplifier here described has been worked with every satisfaction using two transistors of the kind obtainable at a cost of 10s. each from a well-known supplier and without changing any component values.

The current gain of the first stage transistor has been quoted as about 50 times, but it could be as low as 30 times, due to manufacturing spread.

(To be continued)

A TAPE RECORDER DICTATION SWITCH



A SPEECH-OPERATED MOTOR CONTROL
TO CONSERVE TAPE By Hugh Guy

(Continued from page 627 November issue)

THE first resistors to be mounted are R3, R2, R8 and R9. The remaining resistors are mounted above or alongside these four as indicated in the under chassis view. Resistors R4, R5, R6, which are connected to VR1, are best left until the support panel has been attached to the chassis. When this is done C5 and C6 can then be connected and the three resistors coupled to the control, VR1. The connection to V2a cathode from C5 is taken via the 8 BA hole in the chassis by V3. The loudspeaker can also be wired to the transformer primary.

Remaining connections are associated with cable A, which forms a flexible lead from the unit terminated in a four-pin battery plug to mate with the corresponding socket specially mounted for this purpose on the tape recorder.

The socket SK1 is an optional extra and on the unit described in this article has been replaced by a flying lead terminated in a jack plug for direct connection to the tape recorder. Temporary leads can be connected in the first instance to test the unit, a procedure which can now be attempted.

In the final completed wiring the only connections yet to be made are those coupling up the override switch to the appropriate part in the circuit. These are made through the $\frac{3}{16}$ in. diameter hole in the support panel, the override switch itself being mounted in this design on the front panel and therefore lying in the space between the support panel and front panel.

Testing the Unit

The circuit is designed to operate from 250 to 300v. H.T. After plugging in the valves and switching on, the circuit should be left for some five to ten minutes to warm up and stabilise. The 6,000 ohm relay may either be open or closed during this period, but after this time has elapsed rotation of VR1 should cause it to click in and out as a certain point on the track is passed. In a correctly functioning circuit and in reasonable silence the proportion of track covered going from one relay condition to the other, and back again, should be very small and is representative of the "backlash" of the circuit. This degree of "backlash" is very important in determining the sensitivity of operation, and if it is found excessive, resistance R10 should be replaced by one of value 6.8 K.

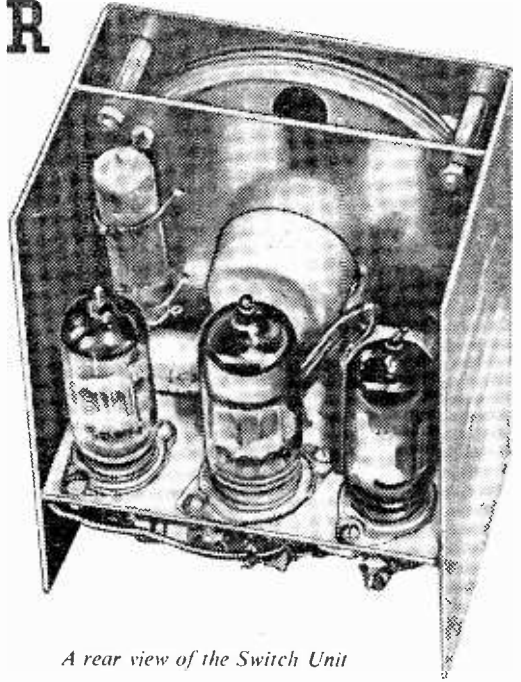

A rear view of the Switch Unit

Adjust the control VR1 so that the relay RL1 just closes. A snap of the fingers in front of whichever is being used as a microphone will now cause the relay to open for about a second. Similarly, speech should cause the relay to open for the duration of the signal. It should not be necessary to bellow into the microphone to make it work, but on the other hand the voice should not be allowed to fall during the use of the device as a more or less constant level is required.

The time for which the relay is operated is controlled by the combination C6, R8. If it is found that the time given by the present combination is not long enough, then C6 should be increased in value. It should be pointed out here that an electrolytic condenser of reasonably low leakage (i.e., one in good condition) should be used here as the leakage resistance of the condenser itself can modify the characteristics of the circuit.

The presence of C4 is to assist in the speed of operation of the circuit. As the diversion of current from V3b to V3a commences the potential at V3b anode rises and this initial rise is fed back to V2a in such a manner as to assist the overall switching of V3 anode current and thereby the switching of motor contacts.

Final Notes

Although the device is direct-coupled, drift problems are practically non-existent once the unit has warmed up, because, unlike a D.C. amplifier, the D.C. levels in the circuit are only critical to within half a volt or so. It is only important in this respect to ensure that the H.T. supply provided by the tape recorder remains at a fairly constant level.



'On Your Wavelength'

BY THERMION

The Ban on Mugeridge

I OBSERVE that the BBC decided not to interview Malcolm Mugeridge on his controversial article written for an American periodical in which he discussed the question of the monarchy and whether Great Britain really needed one. If this question needed to be discussed at all Mr. Mugeridge should not have been allowed to set himself up as an authority on the topic and to discuss the matter as though he were a spokesman for the British nation. He is a self-appointed critic and his views must necessarily be his own, since he cannot have had an opportunity of discussing the subject on a national basis. As such, the RBC was remiss in arranging the interview at all. It should have known, after the resentment felt when Lord Altrincham and the youthful Lord Londonderry voiced their noxious opinions, that such a broadcast would be unpopular. The BBC, however, without any regard for public sentiment and learning of the article which was to be published during the Queen's tour of Canada, thought that it would be a scoop to interview the author of it. There can be no doubt that this was their point of view, because on the evening in question, when the interview was booked to take place, Mr. Mugeridge was to have appeared in another programme where he was to have been the interviewer. At the last moment, it was announced that he was to be interviewed on his article. Had the speaker been someone of the standing of Sir Winston Churchill, the Prime Minister, or someone having national status one could perhaps understand, without excusing, the BBC giving programme time to it. Instead, Mr. Malcolm Mugeridge, who after all is only a BBC entertainer, was considered to be a suitable person to debate such a controversial topic. He is a political nobody and is certainly not qualified to speak to the nation on this subject, upon which his views are of no more value than that of an ordinary citizen. No weight, therefore, could be attached to his views. Mr. Mugeridge, we are told, was paid handsomely for his article. He says that he had no idea, when he wrote his article, that its publication would coincide with the Queen's tour. He might, with a little thought, however, have anticipated such events, and have made it clear that publication should not coincide with the Queen's tour even though when he wrote it the tour had not been finally decided upon.

There is a tendency amongst too many of these BBC entertainers to be controversial. They are all endeavouring to imitate that comic character, the late Cyril Joad. Gilbert Harding is endeavouring to follow in his footsteps and now we have Mugeridge, the ex-editor of a humorous paper, endeavouring to follow suit.

The BBC's judgment in these matters has been

consistently unsound over a long period of years. It has allowed curious people to expound curious views. Quack Joad, for example, was allowed to justify a person taking his own life, in spite of the fact that it is against the law. Lord Altrincham, Lord Londonderry, and even Mr. Mugeridge, as well as the BBC, seemed delightfully ignorant of *lèse-Majesté*, under which, of course, it is an offence to attack the sovereign. The words actually mean "injured Majesty." If such questions attacking the constitution need to be discussed, and I suggest they do not, they should be discussed by competent people, and I opine that Mr. Mugeridge, Lord Altrincham, and the youthful Irishman, Lord Londonderry, are not the people to do so. If the noble Lords are sincere in their expressions of opinion, they should renounce their titles.

The BBC should seek other methods of attracting a listening or viewing audience, and not descend to the level of the yellow press.

Radio and D.I.Y.

FOR many years, the radio trade has adopted the narrow attitude of the closed shop as far as radio repairs are concerned. They will not issue circuit diagrams nor service data to anyone except their recognised dealers, and in some instances will not even supply the press. This is, however, a D.I.Y. era, and the building trade as well as the motor trade, which have adopted a similar policy, are beginning to recant. The exorbitant charges and quite often questionable charges made by some radio dealers for repairs, some of them mythical, have forced many people to endeavour to service their own receivers, as well as their own cars and their own domestic apparatus. The motor trade particularly is beginning to supply service data to members of the public and I suggest that the time is ripe for the radio trade to bring their ideas into line with modern tendencies, especially in these days of high taxation and money shortage.

After all, several firms now make quite a business of hiring out or selling service manuals and sheets, many of which are merely typed or copied prints, and it would thus be in the firm's interests to make certain that authentic sheets were supplied. Of course, out-of-date manuals are a different category and could be hired in the same way as motor-car manuals.

A NEW HANDBOOK AMPLIFIERS; DESIGN & CONSTRUCTION

By F. J. CAMM
17/6, Post 18/-

Containing Designs for Radio, Gramophone, Tape-Deck,
P.A. Amplifiers, with a special chapter on D.C. Amplifiers.

From GEORGE NEWNES, LTD.
Tower House, Southampton Street, Strand, W.C.2



FOR VALVES

6Z1 5/6	5Z43 10/-	6B94 7/6	6U56 8/6	12AT7 9/-	35Z5 9/-	6CL6 9/-	6X4 8/-	6Y5 8/-	6Z5 8/-	6Z6 8/-	6Z7 8/-	6Z8 8/-	6Z9 8/-	6Z10 8/-	6Z11 8/-	6Z12 8/-	6Z13 8/-	6Z14 8/-	6Z15 8/-	6Z16 8/-	6Z17 8/-	6Z18 8/-	6Z19 8/-	6Z20 8/-	6Z21 8/-	6Z22 8/-	6Z23 8/-	6Z24 8/-	6Z25 8/-	6Z26 8/-	6Z27 8/-	6Z28 8/-	6Z29 8/-	6Z30 8/-	6Z31 8/-	6Z32 8/-	6Z33 8/-	6Z34 8/-	6Z35 8/-	6Z36 8/-	6Z37 8/-	6Z38 8/-	6Z39 8/-	6Z40 8/-	6Z41 8/-	6Z42 8/-	6Z43 8/-	6Z44 8/-	6Z45 8/-	6Z46 8/-	6Z47 8/-	6Z48 8/-	6Z49 8/-	6Z50 8/-	6Z51 8/-	6Z52 8/-	6Z53 8/-	6Z54 8/-	6Z55 8/-	6Z56 8/-	6Z57 8/-	6Z58 8/-	6Z59 8/-	6Z60 8/-	6Z61 8/-	6Z62 8/-	6Z63 8/-	6Z64 8/-	6Z65 8/-	6Z66 8/-	6Z67 8/-	6Z68 8/-	6Z69 8/-	6Z70 8/-	6Z71 8/-	6Z72 8/-	6Z73 8/-	6Z74 8/-	6Z75 8/-	6Z76 8/-	6Z77 8/-	6Z78 8/-	6Z79 8/-	6Z80 8/-	6Z81 8/-	6Z82 8/-	6Z83 8/-	6Z84 8/-	6Z85 8/-	6Z86 8/-	6Z87 8/-	6Z88 8/-	6Z89 8/-	6Z90 8/-	6Z91 8/-	6Z92 8/-	6Z93 8/-	6Z94 8/-	6Z95 8/-	6Z96 8/-	6Z97 8/-	6Z98 8/-	6Z99 8/-	6Z100 8/-
---------	-----------	----------	----------	-----------	----------	----------	---------	---------	---------	---------	---------	---------	---------	----------	----------	----------	----------	----------	----------	----------	----------	----------	----------	----------	----------	----------	----------	----------	----------	----------	----------	----------	----------	----------	----------	----------	----------	----------	----------	----------	----------	----------	----------	----------	----------	----------	----------	----------	----------	----------	----------	----------	----------	----------	----------	----------	----------	----------	----------	----------	----------	----------	----------	----------	----------	----------	----------	----------	----------	----------	----------	----------	----------	----------	----------	----------	----------	----------	----------	----------	----------	----------	----------	----------	----------	----------	----------	----------	----------	----------	----------	----------	----------	----------	----------	----------	----------	----------	----------	----------	----------	----------	----------	-----------

TRANSISTORS RED SPOT 10/- ea. YELLOW AND GREEN SPOTS 10/- ea. YELLOW AND RED SPOTS 21/- ea.

PACKING AND POSTAGE 6d. per valve. SAME DAY SERVICE.

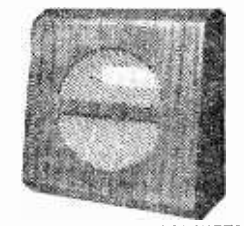

LOUDSPEAKER CABINETS
This attractive walnut finished cabinet is available for 6" or 8" speaker units. Metal speaker feet, complete with back and rubber feet. 6" type. Measures 4" x 8 1/2" x 4 1/2" at base. Price 17/6 each.
8" type. Measures 10 1/2" x 10 1/2" x 5" at base. Price 21/6 each.
5" type. Very similar design. Price 16/6 each.
Postage—any type—2/- each.

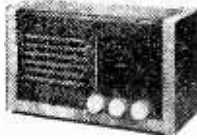

BUILDING A "SECOND" SET
THIS IS THE CABINET TO GIVE YOUR RECEIVER THE COMMERCIAL LOOK. WALNUT FINISHED CABINET—Size 11 1/2" x 7 1/2" x 3". Supplied with Chassis (out on reels), Dial, Back Plate, Drive Cord, Dial Drum, Pointer. Price 27/6 complete—Post 3/-.
WE "STENTORIAN" HIGH FIDELITY SPEAKER UNIT
Model H.F. 1012
10" Discast unit, incorporating 12,000 gauss magnet. £4.10.9.

HEADPHONES-MICROPHONES

EX-GOVERNMENT HEADPHONES AND MICROPHONES
C.L.R. Low resistance type 120 ohms, 7/6 pair.
Throat Microphones, American surplus, complete with strap, lead and plug type. Type 3, 3/- ea.
High Resistance Phones, 1,000 ohms, 13/6 pair.
High Resistance C.L.R. Phones, 16/- pair.
EX-R.A.F. Microphone, Type 48 with Switch, 3/6 each.



LOUDSPEAKER UNITS

Make	Type	Size	Price
Elac	Square	3 1/2 in.	19/6 each
Lee Irons, Hesseey	Round	5 in.	17/6 each
Goodmans, Plessey	Round	6 1/2 in.	18/6 each
Goodmans, R. & A.	Round	8 in.	19/6 each
Plessey, R. & A. Elac	Round	10 in.	25/6 each
Plessey	Round	12 in.	35/- each
Roba	Elliptical	9 in. x 1 in.	19/6 each
Elac	Elliptical	10 in. x 6 in.	25/6 each

All the above are PM units with 2 to 3 ohm speech coils.
R.P.U. 12in. Heavy Duty 20 watts model. 12in. 8 ohms.
Speech Coil, £5.5.0.
5in. Mains Energised Speaker, £1.
6in. Mains Energised Speaker, 17/6.
8in. Mains Energised Speaker, £11.0.
All have field coils of approx. 600 ohms.
SPECIAL OFFER
Just a few 5in. units by Goodmans and Lectrons fitted with standard output transformer, £11.6 each.

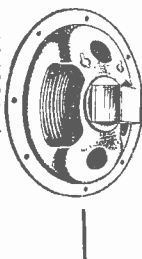

THE "EKE" QUALITY 3 WATT AMPLIFIER

Three International Octal Valves 6BM6, 6V6GT, 6X5GT. A.C. mains fully isolated, negative feedback (voltage and current) controls, volume and tone, input network for modern crystal. Really low hum level and even frequency response. Price 84/- plus 3/- Packing and Post.



RECORD PLAYER UNIT

B.S.R. MONARCH
Four speed automatic record changer. Unit Plays 7in., 10in. and 12in. records automatically with "MAGI-DISK" 3 factor Turn-over Pick-up Unit. Plate 12in. x 10 1/2 in., £8.15.0.
Carriage on above units, 4/6.



COLLARO
Three speed single player. Automatic stop, fitted with "Studio T" pick-up. Cream finish, £8.19.0.
Carriage on above units, 4/6.



COLLARO
Four speed automatic record change unit. A fully mixing automatic changer with many advanced features. Unit plate 12in. x 13 1/2 in., £9.15.0.
Carriage on above units, 4/6.

TERMS: Cash with order or C.O.D. Postage and Packing charges extra, as follows:
Orders value 10/- add 1/-;
20/- add 1/6; 40/- add 2/-; £5 add 3/- unless otherwise stated. Minimum C.O.D. fee and postage 3/-. All single valves postage 6d. Personal Shoppers Monday-Friday 9 a.m. to 5 p.m.



103 LEEDS TERRACE
WINTOWN STREET
LEEDS 7

INTRODUCING THE COMBINED POWER PACK AND AMPLIFIER FOR THE 'MAXI-Q' PRE-SET OR VARIABLE F.M. TUNER WHICH NOW OFFERS YOU A COMPLETE RECEIVER

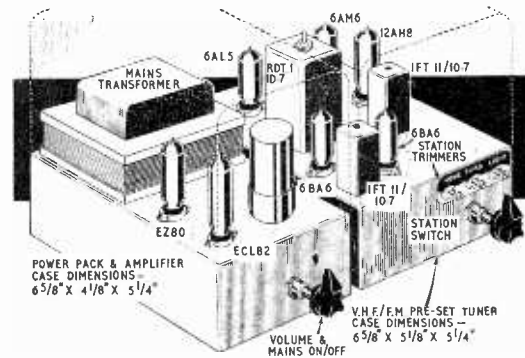

Full constructional details, point-to-point wiring diagrams and alignment instructions for building the "MAXI-Q" COMBINED POWER PACK AND AMPLIFIER, PRE-SET F.M. TUNER and also the VARIABLE TUNED version are given in Technical Bulletin DTB.8, 1.6.

POWER PACK AND AMPLIFIER. This unit consists of Mains Transformer, EZ80 and ECLB2 valves, Volume Control complete with mains on/off switch and is housed in a gold-finished case. Power supplies available for any tuner—Heater 1.5 amps at 6.3V. H.T. from 220V. at 50 mA to 265V. at 20 mA.

The unit is available completely wired and ready for use at £5, 10/-, plus 2/6 carriage or available in kit form at £5.

PRE-SET F.M. TUNER. Completely punched chassis, screens and bronze-finished cover, 19/- Station Indicator Plate, 1, 1. Three-position switch, 4/3. Station Condenser Trimmers, 3-9 pF, 2/-.

RATIO DISCRIMINATOR TRANSFORMER. RDT 1-10.7 Mc s. Secondary winding of bifilar construction, iron dust core tuning, polystyrene former, silver mica condensers. Can size 1 1/2 in. sq. x 2 1/2 in. high, 12/6.

I.F. TRANSFORMER. IFT.11/10.7 Mc s. Miniature I.F. of nominal frequency 10.7 Mc/s. The "Q" of each 1.6.

winding is 90 and the coupling critical. Can size 13/16 in. sq. x 1 1/2 in. high, 6/6.
COILS, TYPE L1, T1 and T2. Specially designed for use in this unit, are wound on polystyrene formers complete with iron dust core tuning, 3/11 each.

THE "MAXI-Q" PRE-SET F.M. TUNER is available completely wired, assembled, valved and housed in a sturdily made gold-finished cover at £8/11/5, plus £3/8/7 P.T. = £12.

VARIABLE F.M. TUNER completely assembled at £7, 17/2, plus £3 2 10 P.T. = £11 (carriage 3/-, terms c.w.o.).

GENERAL CATALOGUE covering technical information on full range of components, 1/-, post free.

TRADING TERMS for direct postal orders, c.w.o., plus appropriate postal charge. Please send s.a.e. with all enquiries.

DENCO (CLACTON) LTD. (Dept. P.W.), 357/9 Old Road, Clacton-on-Sea, Essex

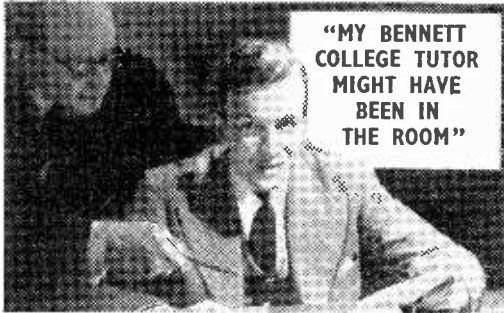

"MY BENNETT COLLEGE TUTOR MIGHT HAVE BEEN IN THE ROOM"

PERSONAL POSTAL TUITION

WHAT CAREER DO YOU WANT?

Architecture	Surveying
Building	Telecommunications
Carpentry	Television
Commercial Art	
Diesel Engines	Book-keeping
Draughtsmanship	English
Electrical Eng.	Geography
Electric Wiring	Journalism
Forestry	Languages
Locomotive Eng.	Mathematics
Machine Design	Modern Business
Mechanical Eng.	Methods
Motor Engineering	Police Subjects
Plumbing	Salesmanship
Quantity Surveying	Shorthand
Radio Engineering	Short Story Writing
Sanitary Science	and many others

OR WHY NOT OBTAIN A QUALIFICATION?

A.M.I.C.E.	A.M.I. Mun. E.	A.C.I.S.
A.M.I. Mech. E.	A.M.S.E.	A.C.C.S.
A.R.I.B.A.	A.A.C.C.A.	A.R.I.C.S.
A.M.I. Struct. E.	A.C.W.A.	A.A.J.
GEN. CERT. OF EDUCATION & R.S.A. Exams.		

Every Bennett College student enjoys this friendly, intimate coaching right through his Course. A few of the Courses are listed opposite. Tell us your subject. We will send you The Bennett College Prospectus and the famous FREE book "Train your mind to SUCCESS." This will show you how you can advance to a better, finer future by Personal Postal Tuition. Fill in and post the coupon today.

BENNETT COLLEGE
 (Dept. L. 104 PT) SHEFFIELD

Please send me the Prospectus on..... and my free copy of "Train your mind to SUCCESS."

NAME.....
 ADDRESS.....
 TOWN.....
 ADDRESS.....
 AGE (if under 21).....
 Please write in BLOCK letters

Post this coupon NOW!

EDDY'S (Nottm.) LTD.

(DEPT. P.W.)

172 ALFRETON ROAD, NOTTINGHAM

THIS MONTH'S SPECIAL OFFERS

SINGLE-PIECE THROAT MIKES. 1/- each, post, etc., 3d each. Could be used for electrifying Musical Instruments.
RECORDING TAPE. 1,200ft. reels, 9/11 each, postage, etc., 1/- extra.
GERMANIUM DIODES. New and Guaranteed. 1/- each, 10/- a dozen, post extra 3d.
MIDGET BATTERY ELIMINATORS. To convert all low-consumption Portables for Mains operation. Mains input 220/240 v. A.C., H.T. output 85 v. 10 mA. L.T. output 1.3 v. 125 mA. Size 3.7 in. x 2.5 in. Actually smaller than H.T. battery alone! Amazing price of 55/-, plus 2/6 extra post and packing. ALL NEW AND GUARANTEED.

Any parcel insured against damage in transit 6d. EXTRA.

NEW AND GUARANTEED

VALVES

All Tested before dispatch.

Post, etc., 6d. per valve extra. Over £2 FREE.

1RS	7/11	6X5GT	7/6	958	3/11	EF80	8/-
1S5	7/3	7B7	8/6	AZI	12/11	EF41	9/3
1T4	7/3	7C5	8/6	DAF96	9/6	EF86	12/11
3Q4	8/11	7C6	8/6	DF96	9/6	EF89	9/6
354	8/6	7H7	8/6	DK96	9/11	EF91	6/11
3V4	8/6	757	9/6	DL96	9/6	EL84	8/11
5Z4G	9/6	7Y4	7/11	DM70	7/11	EZ80	8/-
5Y3GT	7/3	10F9	11/9	EABC80	7/6	GZ32	12/6
6BA6	6/6	1457	12/11	EB91	6/11	PCC84	8/-
6B16	7/6	25L6GT	10/6	ECC81	8/11	PY81	8/11
6B8G	3/6	35L6GT	9/11	ECC82	8/11	PY82	8/3
6F15	13/11	35A5	10/6	ECC83	8/11	UBF80	9/6
6K7G	2/11	35W4	0/11	ECC84	10/11	UCH42	9/11
6Q7G	7/11	35Z4G	8/3	ECC85	9/-	UF41	8/11
6Q7GT	8/3	954	1/6	ECH35	10/6	UY41	7/11
6U4GT	13/11	955	3/11	ECH42	9/6	U25	13/6
6V6GT	5/11	956	2/11	ECL80	8/6	VU111	2/6

A Transistorised Pulse Generator

THIS UNIT HAS MANY APPLICATIONS IN MODERN ELECTRONIC TECHNIQUES

By B. E. Wilkinson



ORIGINALLY designed as the basis of a winking light system for a motor car, the device has been found of great use where short duration pulses of fairly low frequency are required.

The generator consists essentially of a capacity, charged through a resistance and suddenly discharged, the frequency of the pulsing being dependent upon the values of the charging capacity and resistance. The circuit is shown in Fig. 1. An unusual feature is the use of the coils of the relay as transformer windings. In the first model built, a transformer was necessary. The relay windings, however, were found to be separate, and an attempt to use these as a 1:1 transformer proving successful, the transformer was abandoned. The components required are as follows: One relay type AP 52257 (resistance of each coil 250 ohms), obtainable from Electronic Precision Equipment, 1, Sutton Road, Eastbourne, one 250 K Ω miniature potentiometer, 25 μ F electrolytic condenser, A.F. red spot transistor, 47 K Ω $\frac{1}{2}$ watt resistor, small strip of aluminium, wire for wiring, 30 volt battery.

Constructional Data

Since the relay forms the chassis for the pulse generator, we will begin with a short description of this component. There are five leads from the relay, two to the coils, a common contact and one make and one break. The terminal block (as in Fig. 2) carries four tags, two of which are among the five lead out connections. These four tags go directly to the coils. In order that the coils shall be connected in series, there is a small piece of wire joining two of these tags. It should be removed, so that the relay coils become separate. Underneath the terminal block are three tags. These correspond to the make, break and common lead to the contacts of the relay. The relay is designed to be mounted by means of two 4 B.A. screws, which will fit two tapped holes on the right-angled projection of the relay frame. If the screws are not provided it is well to obtain some, since they are necessary for affixing an aluminium bracket which will carry the potentiometer. The various screw adjustments of the relay should not be touched until the unit is complete.

Construction

The aluminium bracket must be made first. Fig. 3 gives the actual shape and dimensions. A suitable piece of aluminium can probably be found in almost any spares box. The thickness is immaterial so long as the bracket is fairly rigid. The potentiometer should now be fixed to the bracket through the $\frac{3}{4}$ in. hole and the bracket fixed to the relay by means of the 4 B.A. screws. The transistor leads should be trimmed to measure $\frac{3}{4}$ in. and short lengths of sleeving put over them. Having trimmed the ends of the leads, taking care not to overheat the transistor, it may now be soldered into position. The collector lead goes to the outermost of the four tags while the emitter lead goes to the innermost tag (the illustration shows this). The base lead is connected to the 47 K Ω resistor, which is then taken to the fixed side of the potentiometer. The other side of the potentiometer is joined by a lead, passing under the transistor and the relay

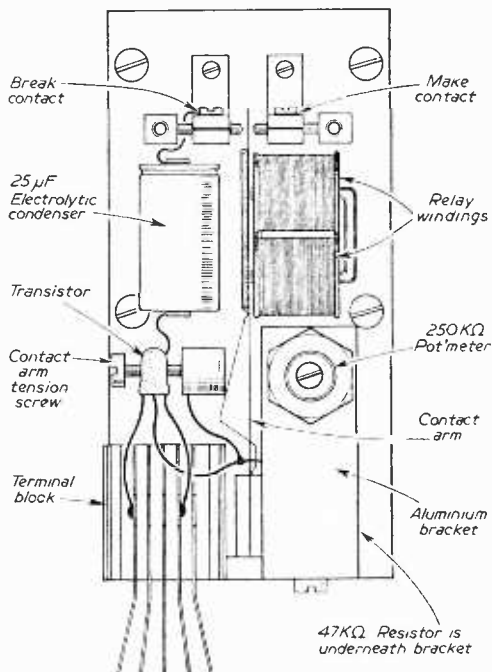

Fig. 2.—Lay-out and wiring.

contact arm, to the second tag (next to the collector tag). The third tag is connected by a short lead to the outermost tag underneath the terminal block. This tag, it will be seen, is connected to the break contact. The condenser is now connected, positive lead to the break contact, and negative lead to the junction of the emitter lead and the 47 K Ω resistor. This resistor cannot be seen in the illustration as it is underneath the bracket.

The power supply lead may now be taken from the unit.

Of the five lead out connections to the relay, the upper two form the power supply connections. The right-hand one, being connected to the emitter, is obviously the positive connection, the left-hand one being the negative. One should be very careful of this polarity, since confusion over it may lead to the incorrect application of voltage, and the transistor will then be ruined. It is a very good plan to use coloured wire—black for negative and red for positive—since, once the connections have been correctly made, one need not then worry about confusion over polarity.

Connections

Before connecting to the power supply, check the circuit once more. When satisfied that all has been connected correctly, the 30 volts may be applied. If the unit is functioning correctly the contact arm will be pulled

from the break contact and released at a particular frequency. Varying the potentiometer values will either increase or decrease the frequency. Failure of the unit to function will be due (assuming that the transistor and other components are not faulty) to:

- Bad adjustment of the contact arm, or
- Phase reversal in the collector and base circuits.

Three screws are provided for tension adjustment, though if it is suspected that such adjustment is necessary, one should place a finger on the contact arm with the unit switched on. One can then feel the pulsing of the generator. Should adjustment prove necessary, the screws on the make and break contacts should be slackened off and the contacts unscrewed slightly. The tension screw just beneath the transistor should be loosened and then gradually tightened until the generator is pulsing correctly. Movement of the arm should be seen as a clean, sharp jump. Once the motion of the arm is satisfactory, the contact screws may be tightened until the action of the unit causes the break and make contacts to operate once per pulse. Finally, the screws holding the contact tight should be secured.

If no pulsing of the arm can be detected, and it is certain that the circuit is not functioning,

then the fault lies in the phasing of the collector base circuits. To remedy this merely entails reversing the coil connections to tags 1 and 2. To do this the collector lead and potentiometer lead must be disconnected, then the coil leads can easily be removed and reversed. The collector and potentiometer leads can then be soldered back in their original position.

The effect of this action is to bring the collector in phase with the base. There is now no reason why the pulse generator should not work correctly.

The frequency of the pulse generator depends on the values of R, C, and increase of either of these values produces a lower frequency. The frequency range of the unit as described is approximately $\frac{1}{3}$ cycle per second to 10 cycles per second. This may not be suitable for every purpose, but the reader will easily find, by variation of C, which range is to him most desirable. The lowest frequency the author could achieve was 1 cycle per 35 seconds! C was 1,000 μ F, and the potentiometer was disconnected, making R effectively infinite.

As to supply voltage, the 30 volt deaf aid batteries work the unit admirably and were chosen because of their availability. If it is desired to work the unit from a lower supply voltage, the Ever-Ready B.1578 12-volt recorder battery is admirable. The pulse generator will function from a 4.5 flashlight battery. However, it must be pointed out that the lower the supply voltage, the less distinct will be the movement of the arm, until finally, when the voltage is very low, the current flowing in the circuit will be insufficient to operate the arm.

One final point—when using the pulse generator do not allow the current flowing through the make or break contacts to an external circuit to become excessive. They are not designed to carry heavy currents, and, if forced to, would soon burn away. If it is desired to use the generator in a circuit carrying heavy current, such as a motor car winking light system, the contacts should be made to operate a further relay capable of carrying more current.

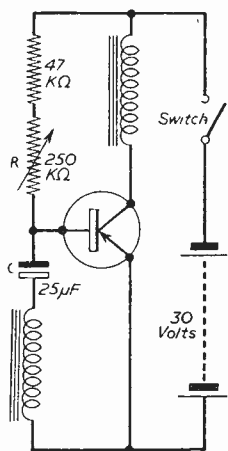

Fig. 1.—Theoretical circuit.

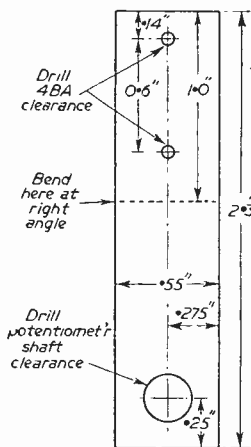

Fig. 3.—The aluminium bracket.

Ideal for The Beginner

Eighth Edition

WIRELESS TRANSMISSION

By F. J. CAMM

6/-, by post 6/4

From

GEORGE NEWNES, LTD.,

Tower House, Southampton Street, Strand, W.C.2.

Amplification at V.H.F.

THE POPULARITY OF F.M. HAS RE-AWAKENED INTEREST IN V.H.F. SOME CIRCUITS ARE DISCUSSED HERE

BY the term "Very High Frequency" is meant that portion of the frequency scale that lies between 30 and 300 Mc/s. or waves having a wavelength of from 10 metres to 1 metre. Now this band of frequencies covers the higher frequencies on a short-wave receiver, the television and the frequency modulation sets, so an insight as to their working is of interest.

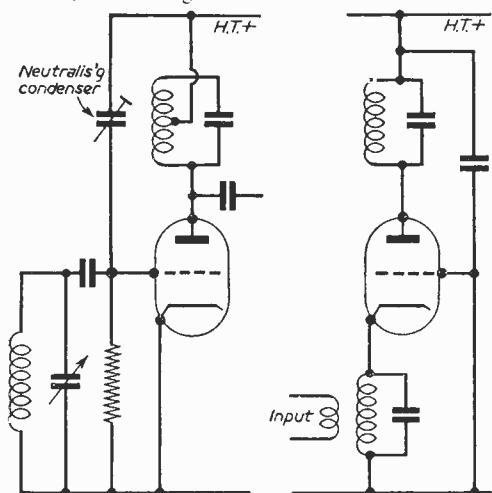

Fig. 1.—Triode neutralised stage. Fig. 3.—Cathode input, or earthed grid stage

When amplifying radio frequencies, the higher the frequency the more difficult it is to do so. The reasons for this are:

- (i) The transit time for electrons to pass from cathode to anode of a valve becomes an appreciable fraction of a cycle, and thus gives rise to losses.
- (ii) The inter-electrode capacitances, though small, can cause oscillation.
- (iii) Tuning capacitors must have very low self-inductance.
- (iv) The input resistance of the valve at very high frequencies, falls, thus damping the grid circuit and reducing the anode load of the preceding stage. This calls for more power to drive it.
- (v) Skin effect. This is due to the fact that very high frequencies tend to travel only on the outside of the conductors, thus increasing their effective resistance.
- (vi) The wiring to the valve itself has appreciable reactance.

Triode Used as V.H.F. Amplifier

The triode if used as an amplifier for very high frequencies has to be neutralised. This is due to the fact that the anode/grid capacitance of the valve itself gives a feedback between the input and

output circuits. This generally causes oscillation or severe loss of gain. Fig. 1 shows a triode as a neutralised triode amplifier. Here the neutralising condenser provides another feedback path of opposite phase and stabilises the circuit. Unfortunately this will not hold good over a wide range of frequencies, so the neutraliser must be altered when changing frequency.

Using a balanced push-pull amplifier and cross-neutralising, this can be overcome and the circuit will be stable over a wide band. Fig. 2 shows this circuit.

Grounded Grid Amplifiers

In the normal amplifying circuit, the input is applied between grid and cathode, with the cathode near or at earth potential. In this type of amplifier, however, the grid is earthed and the input applied to the cathode (Fig. 3). It will be noticed here that the anode/grid capacitance is across the tuned output circuit, so there is no feedback and neutralising is not required. The fault with this circuit is that its low input impedance heavily damps the aerial circuit, so causing very low aerial circuit gain. It also gives poor selectivity. As the cathode is "hot" in a grounded grid stage, the heater/cathode capacitance will call for chokes in the heater leads.

The Cascode Amplifier

This circuit has developed from the grounded grid amplifier and is now used in most tuner units of television sets and in some frequency modulation receivers. Fig. 4 shows one using two separate triodes and Fig. 5 a double triode valve.

As will be seen from the circuit, the first triode is an ordinary triode amplifier followed by a grounded grid triode. This ensures a low noise output and also the grounded grid triode acts as

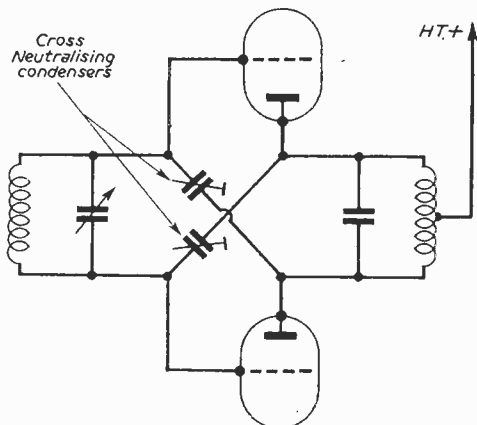

Fig. 2.—A cross-neutralised stage.

buffer between the oscillator and the aerial and thus prevents radiated oscillation. As the anode load of the first triode is low, due to the low impedance input of the second triode, neutralising is not necessary.

grid/cathode capacities of the valve. There will be no feedback.

It will be noticed in Fig. 7 that the grid is effectively shorted to earth by a capacitor at the frequency used. This should be of a low series inductance type. The gain of this amplifier is quite good and has the advantage of low noise. When a double triode valve is used the two triodes are generally screened from each other and care is taken to minimise capacity between them.

Fig. 4.—The cascode amplifier stage—familiar to TV enthusiasts.

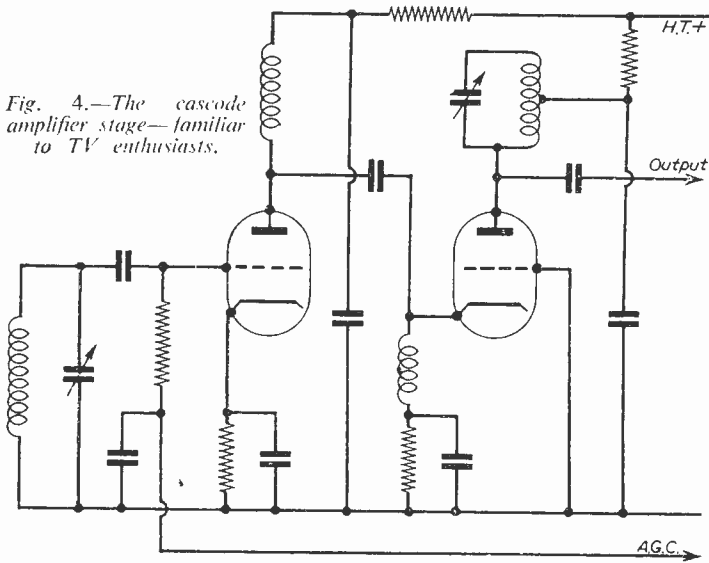

Precautions to be Taken

The capacitors used as decouplers must offer a low impedance at the frequency used. Low inductance is of more importance than high capacity. If instability occurs it may be necessary to decouple heaters by means of chokes and condensers to prevent

In Fig. 6 is shown a direct coupled cascode amplifier. This circuit is more efficient, for if automatic gain control is applied, it increases the anode cathode voltage of V2 and thus increases the value of grid bias required for anode current cut off. The valve thus has variable μ . It will be noticed that neutralising is necessary here but an alternative circuit as shown in Fig. 7 renders this unnecessary, as if the two condensers C1 and C2 are in the same ratio as the anode/grid and

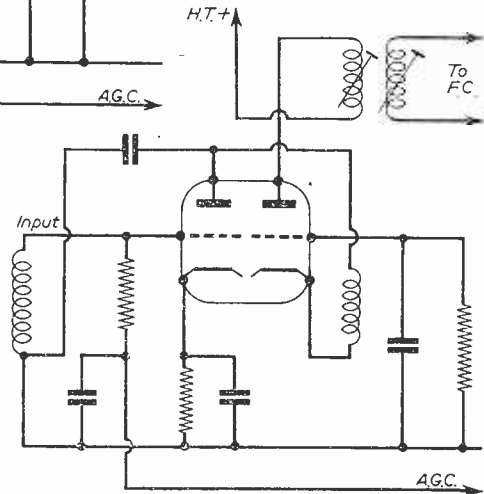
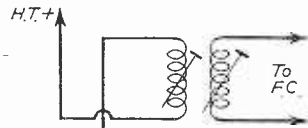

Fig. 5.—A double triode in the grounded grid arrangement.

feedback between the various stages. Earths should be taken to the nearest point on valveholders and in the tuning circuits be careful that the chassis is not a part of the circuit. For instance, the earth end of the input coil should be connected to the same point as the cathode decoupling condenser. Leads should be kept as short as possible as at very high frequencies even the shortest has an appreciable reactance.

Frequency Changing

At very high frequencies it is usual to employ a local oscillator valve and a mixer valve. The oscillator frequency is nearly always above the signal frequency. The circuits employed in the

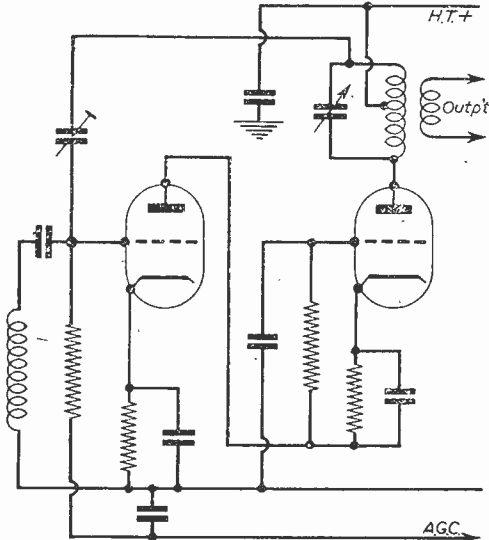

Fig. 6.—A direct-coupled cascode amplifier.

oscillator are either Hartley or Colpitts. The main problem encountered in these circuits is drift. Receivers should always be allowed to warm up for quite a time before any alignment takes place. It is usual to have condensers of

a pentode, but when a triode is used it is necessary to neutralise it, owing to feedback being set up at the intermediate frequency. This can be achieved either by a capacitor between the load resistance of the mixer and ground or by means

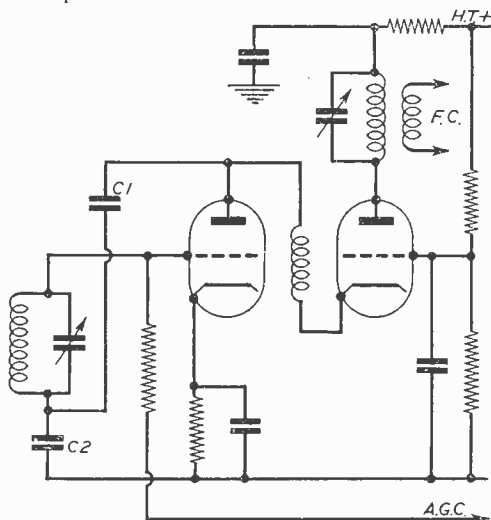

Fig. 7.—A modified Fig. 6 to avoid neutralising.

positive and negative co-efficients, combined to combat this drift. A circuit of a V.H.F. oscillator and mixer is given in Fig. 8. Here the mixer is

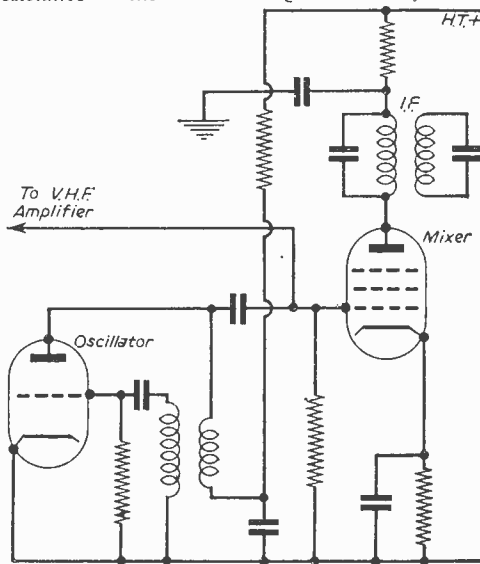

Fig. 8.—A V.H.F. oscillator—mixer stage, of an extra winding on the I.F. transformer, coupling the I.F. to the cathode of the mixer.

Speeding Circuitry Design

RAPIKON, the rapid construction electronics chassis system, has been released by Shandon Electronics Ltd.

Departing entirely from the concept of the conventional box chassis, Rapikon gets down to basic fundamentals in chassis construction, eliminating all preparatory metal work. The component parts—which are firmly held on a rack—require only to be screwed together, assembled in a matter of minutes.

Pre-punched holder plates take such focal components as valves, etc. These plates are individually placed where required. One end is pronged so that they can be slipped into position behind tag panels and components and just as easily moved if necessary. Wiring can consequently be kept short. The slotted plates and girders are mounted vertically on the rack to any required layout.

Because of this vertical layout, components are always accessible for wiring, replacement or measurement. Layouts can easily and rapidly be modified. Several chassis or circuits can be simply connected to one another without taking up bench space and with no flying leads.

But Rapikon is more than just a "chassis-in-minutes" kit. It is a carefully designed method for the experimental assembly of complete electronics systems, with each chassis forming a block of the system block diagram. A modified version of any block can be constructed and inserted when ready—without disrupting work on the system as a whole.

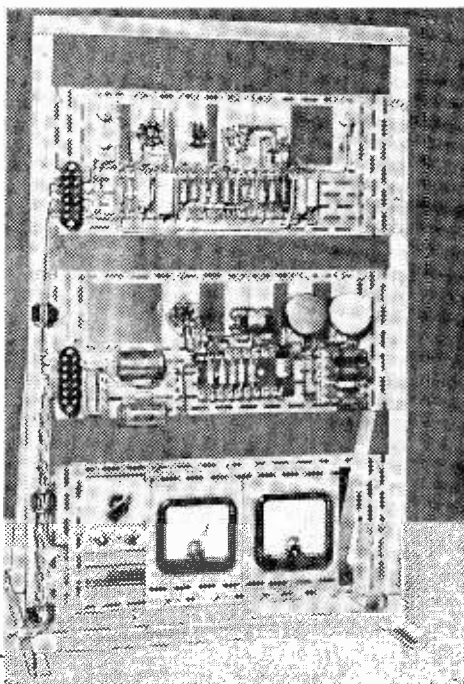

The "Rapikon" chassis

THERE are available nowadays very reasonably priced record players, especially those with crystal pickups, and they are capable of giving excellent quality when used with a good amplifier and speaker system. I wanted such an amplifier, but my enthusiasm, like that of a great many of us, is often severely damped when the cost involved is considered. I therefore set out to see what could be accomplished with ordinary standard components and valves that I had on hand, and which, anyway, are cheaply and easily obtainable. I had in mind the following basic features:

- (1) About 6-8 watts push-pull output maximum.
- (2) Negative feedback where possible.
- (3) Simple controls for compensation of record characteristic.
- (4) Straightforward circuitry with no tricky adjustments.

The circuit which I finally drew up satisfies these conditions, and details are shown in Fig. 1.

Circuit Details

V1 is a pentode voltage amplifier working at high gain, and an EF37A was used here because I had one, but if preferred a 6J7 could be used instead. Simple switched bass-boost and top-cut compensation is provided by S1 and S2 respectively. V2 (6SL7) is a "floating" paraphase type of phase splitter, and this circuit is to a large degree self-balancing, and also contributes some gain. Another advantage is that the output from each triode has only to be half the input grid-to-grid drive voltage to the output valves. The output stage employs a pair of 6V6's connected in class AB1 push-pull. Negative feedback is taken from the secondary (15-ohm) winding of the out-

A PUSH PULL

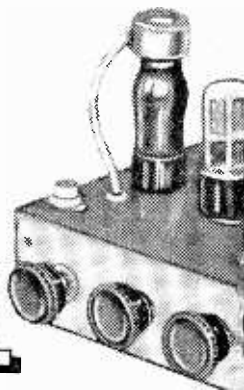

GRAMPHONE AM

PRIMARYLY DESIGNED FOR RECORDS, THIS RADIO AMPLIFICATION

put transformer via R23 to the cathode of the first half of V2. The power pack is conventional and a 5Z4 is used as a full wave rectifier.

Construction

I possessed a four-sided aluminium chassis 12in. X 8in. X 2½in. and the layout used on this is shown in Fig. 2. This chassis is perhaps a little large, but my mains transformer (a drop-through type) was a hefty one, and if an upright type is used this usually takes up less chassis room. In

order to minimise any possibility of interaction between mains transformer and L.F. choke, the mounting of these components should, if possible, be arranged so that their axes are at right angles. In this respect the output transformer has been mounted well away from the power pack. The valves should be well spaced from one another and to act as a guide, suggested dimensions for positioning the valveholders are shown in Fig. 3. I always find it easiest, when deciding on the size of chassis, to arrange the main components on a sheet of paper. Then when the chassis is obtained those components are again arranged to facilitate marking out. An important point which should be borne in mind is that electrolytic capacitors should not be mounted too near output or mains rectifier

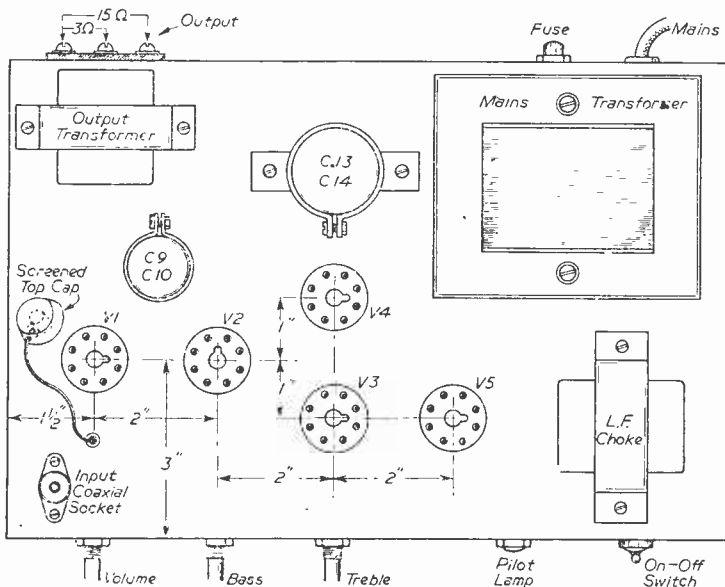
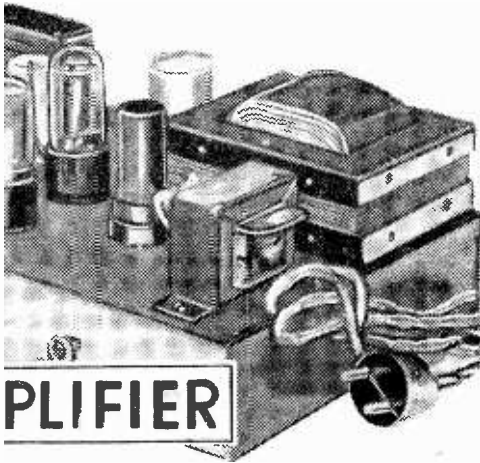

Fig. 2.—Layout and drilling data.



AMPLIFIER MAY ALSO BE USED FOR

By C. Newport

valves as the heat generated may in time cause these capacitors to "dry up."

The heater leads were run in well-twisted pair and dressed hard against the chassis bottom, well away from grid pins. One side of the 6.3 volt heater supply was connected to chassis at the mains transformer—this is essential, as otherwise

a mysterious harsh form of hum becomes apparent. A 500-ohm "humdinger" was tried across the 6.3 volt supply, but I could detect no difference with it in, and it was subsequently removed. Of course, if the 6.3 volt winding on your mains transformer has a centre tap, this is connected to chassis.

All the earth returns associated with V1, that is, the bottom ends of R1, C1, R5, C2, are returned to a single tag fixed under one of the bolts holding the input socket, as in Fig. 3. Insulated screened cable is used where indicated and the metal braiding is earthed at one end only, as shown in Fig. 3. V1 should be a shielded type valve, and pin. No. 1 on the valve-holder is earthed; a screened top-cap is used for V1. The tone compensating capacitors should be grouped in front of their respective switches. The wiring here should be kept as short as is practicable, to avoid hum pick-up, even though the negative feedback will help to cancel this. No screened leads were found necessary in the wiring of the tone compensating circuit.

All the resistors used were ± 20 per cent. tolerance except for R15 and R16, which should ideally be ± 2 per cent. high stability types—the closest tolerance I had were ± 5 per cent., and these were used, but I hope to replace them later. You have to watch that you do not wire R15 and R16 to the wrong output valves, as they have different values. To be effective the grid and screen stoppers R19, R20, R21, R22, should be wired directly on to their respective valveholder tags

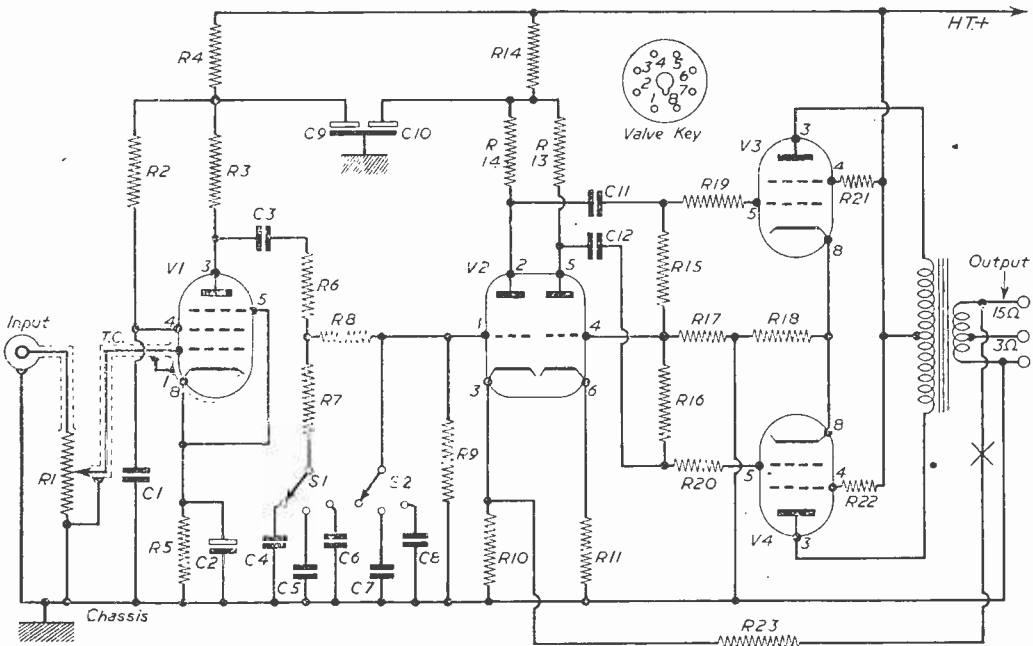

Fig. 1.—Theoretical circuit of the amplifier.

with a short wire-end between tag and resistor—the length of the opposite wire-end is immaterial.

Most of the under chassis components were wired self-supporting between valveholder tags, etc., and where this was not practicable, 3- and 5-point tag strips were used for support.

Negative Feedback

There is a limit to the amount of feedback that can be used when employing the ordinary comparatively inexpensive output transformer. as if this is increased too much there is the danger of oscillation due to phase shift. This oscillation is supersonic and is very hard to detect without an oscilloscope. For this reason R23 should not be lower than 39 K ohm. I actually reduced R23 to 22 K ohm in my amplifier and there was no sign of instability checked on a scope. Unless, however, you

(Concluded on page 734)

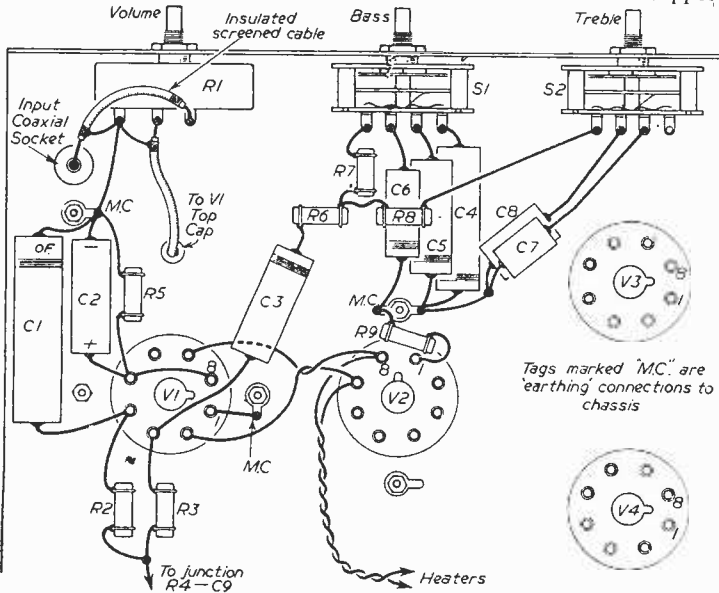

Fig. 3.—Wiring details of V1 and the tone control circuits.

The coupling capacitors C3, C11, C12 should be beyond reproach as regards leakage, and it is better not to trust used ones, unless you have a means of checking their insulation resistance. Incidentally, a very simple way to check this is to connect the capacitor from the H.T. + line via a voltmeter (switched to 250 volts) to chassis. If there is the least sign of a steady reading on the voltmeter, the capacitor should be scrapped.

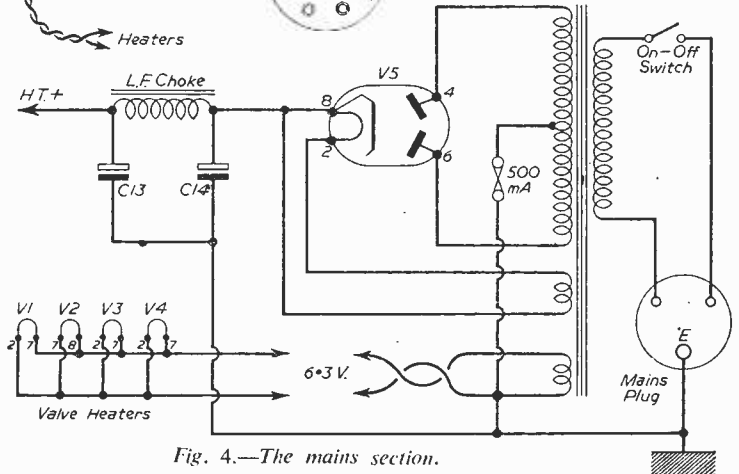

Fig. 4.—The mains section.

COMPONENTS LIST

- RESISTORS** (All $\frac{1}{2}$ w. $\pm 20\%$ unless stated otherwise.)
 R21 22—100 Ω
 R18—250 Ω 3 w.
 R5 10 11—2.2. K Ω
 R19 20—4.7 K Ω
 R14—10 K Ω *
 R4—22 K Ω
 R23—39 K Ω
 R7—47 K Ω
 R8 12 13—100 K Ω .
 R3 17—220 K Ω
 R15—220 K Ω $\pm 5\%$
 R16—270 K Ω $\pm 5\%$
 R6—470 K Ω
 R2—680 K Ω
 R9—1 M Ω
 R1+ .1 M Ω volume control

- SWITCHES**
 2 S.P. 3-way rotary
- VALVES**
 V1—EF37A or 6J7
 V2—6SL7
 V3/4—6V6
 V5—5Z4

- CAPACITORS**
 C7—200 pF mica
 C8—750 pF mica
 C6—0.01 μ F 350 v. paper
 C5—0.05 μ F 350 v. paper
 C3, 4—0.1 μ F 350 v. paper
 C11, 12—0.1 μ F 500 v. paper
 C1—0.25 μ F 350 v. paper

- C9, 10—8 + 16 μ F 350 v. electrolytic
 C13, 14—32 + 16 μ F 450 v. electrolytic
 C2—50 μ F 6 v. electrolytic

- PUSH-PULL OUTPUT TRANSFORMER**
 To match 6V6's to 3 Ω and 15 Ω speakers.

- MAINS TRANSFORMER**
 250-0-250 v. 100 mA
 6.3 v. 3 A.
 5 v. 2 A.

- L.F. CHOKE**
 10 H. 100 mA.

Components—Faults and Testing

A CLASSIFIED LIST OF THE MORE COMMON FAULTS MET WITH IN A RADIO RECEIVER, AND THE TESTING OF ORDINARY COMPONENTS

THE basic components of a radio receiver may at times have faults that cause either poor reception, or perhaps complete failure of the receiver. These faults can be classed as under.

Resistors

Open-circuit caused through excessive power dissipation, deterioration, or developing high or low resistance at wide variance from their stated ratings.

Condensers

Short-circuit or D.C. leakage. Open circuit through breaking of internal connections, loss of capacity as in electrolytics through "ageing."

Transformers

Open-circuit windings through excessive power dissipation or bad manufacture, short-circuiting of turns or sections, loose turns causing inductance to vary, or loose laminations of core.

Coils

Open-circuit windings, poor insulating material of formers causing poor Q.

Now all of these components, if faulty, can be replaced, but if one is dealing in repairs to radio receivers, it is as well to be able to check these parts to see whether they are faulty or not.

The purpose of this article is to explain how small and not elaborate test apparatus can be made up to check these components. With one exception, the Megger, all these testing layouts can be easily and quickly hooked up.

Resistors

It is presumed that nearly all readers have a multi range ohm-voltmeter, in which case the values of resistors up to 5 or 10 megohms can be checked, but for very accurate resistance testing a bridge is perhaps best. Fig. 1 gives a "Wheatstone Bridge" for resistance measurement. Here are four resistances in a closed square, with

a small D.C. voltage applied across corners A and C. A galvanometer is connected across B and D. The current from the battery divides and through path A B C will be $V/(R_2+R_3)$ whilst through path A D C we have $V/(R_1+R_4)$.

The voltage across BC = $\frac{R_3}{R_2+R_3} V$ and across DC = $\frac{R_4}{R_1+R_4} V$ whence $R_4 = \frac{R_1}{R_2} R_3$

So that if R4 is the unknown resistance, R3 is variable and can be adjusted so that this condition is complied with, there will be no difference of voltage between points B and D, the galvanometer will not read and the bridge is balanced. R1 and R2 are the ratio arms. If they are equal in resistance then $R_4=R_3$, but by making them, say, $R_2=100R_1$ we shall balance if $R_3=10R_4$. By varying the ratio of R1/R2 we can measure from 1 ohm up to 1 megohm according to this ratio. R3 can be made up in a series of 10—1 ohm steps, 10 of 10 ohms, etc., of it can be a calibrated rheostat. The resistance across the galvanometer is to prevent it being damaged when the bridge is off balance.

Condenser Testing by Bridge Methods

In Fig. 2 a simple bridge for capacitor testing is given. This is known as a Wien bridge. C1 and C2 are the ratio arms, C3 is a calibrated variable condenser and C4 the condenser under test. The oscillator or source of A.F. is switched on and the standard variable capacitance altered until no sound is heard in headphones, then if $C_1=C_2$ then $C_3=C_4$. If no silent point is reached then the unknown is either larger or smaller than the limits of C3. If so, C1 must be made unequal to C2 so that C3 may be unequal to C4 in the same proportion. That is

$$C_4 = \frac{C_2}{C_1} C_3$$

Another type of capacity bridge does not need a calibrated variable condenser (see Fig. 3). The ratio arms here are the resistance arms. R1 should be about 10K ohms. If R2 is 10K ohms and R is 1K ohm, the ratio of

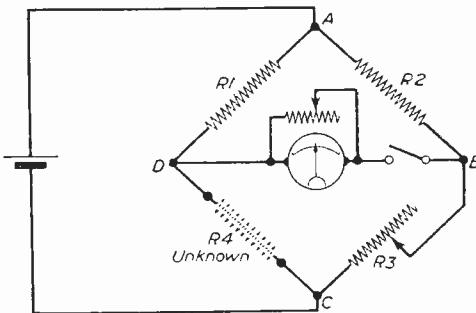
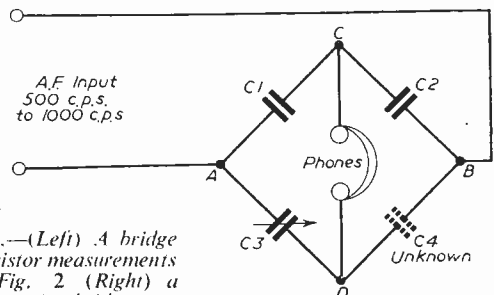

Fig. 1.—(Left) A bridge for resistor measurements and Fig. 2 (Right) a capacity bridge.



the bridge is variable from 1.1 to 1 down to 0.1 to 1. C is a standard fixed condenser and should be of absolute correct capacity. Here $Unknown = \frac{R1}{R + R2} \cdot C$. Thus if $C = 100\text{pF}$, capacitances can be measured from 91 pF to 1,000 pF. If R1 is changed to 1,000 ohms the range is 9.1 to 100 pF whilst with R1 at 100,000 ohms the range is 910 to 10,000 pF. For the standard condenser use a silver mica type.

Testing Large Condensers Not Electrolytics

For condensers over .01μF the A.C. method is quite satisfactory. See Fig. 4. Here the current flowing is measured. The capacity is given by

$$C = 159 I/Vf \text{ microfarads.}$$

where V = applied voltage

I = current in milliamps

f = frequency of supply.

Care should be taken that condenser under this method is not short circuited, and that the voltage applied is not too high for it.

Insulation of Condensers

Insulation, especially of paper condensers, is liable to deterioration. A good check can be obtained by testing its capabilities of holding a charge. Place a battery of about 100 volts across it and on removing the battery the condenser should be able to retain its charge for about five minutes, even longer in the case of a high-class condenser. Should there be a leakage, either surface or internally, the charge will leak away. If a high resistance voltmeter set to volts reading was placed across the condenser immediately the battery was removed, it should show a high reading and gradually drop as the charge leaked away through the resistance of the voltmeter. This should be done two or three times, and if the condenser is O.K., there should be little or no divergence between the maximum readings.

Transformer Tests

The main tests to be carried out on suspected faulty transformers should be for insulation between windings. This should be done with a Megger. Checking voltages on secondaries should be carried out with an A.C. voltmeter with a load across it equal to the normal load. A no-load check should also be taken. This is the magnetising current of the transformer and should not exceed 25 per cent. of the full load. If excessive,

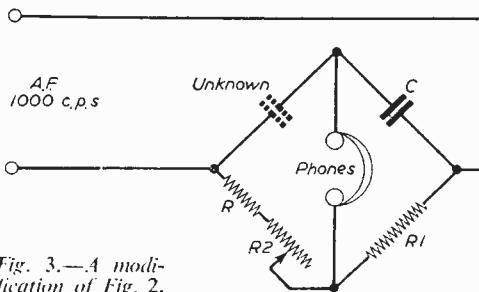

Fig. 3.—A modification of Fig. 2.

it can be that there is insufficient iron in the core or there are short circuited turns.

A Neon Tester

Fig. 5 shows a comparison tester. A neon lamp is connected in series with a high resistance R across a D.C. supply of 200 volts. The neon lamp will not conduct till the voltage reaches a certain value. The condenser C charges, but the

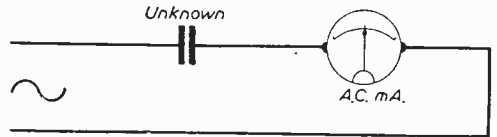

Fig. 4.—The A.C. method of measuring large condensers.

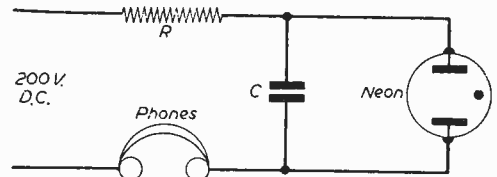

Fig. 5.—A simple neon tester.

charge is delayed by R. When the voltage reaches the striking value of neon it conducts and partially discharges C. This process goes on, charge and discharge in regular sequence. If the value of C and R cause this to take place hundreds of times a second a note will be heard in the phones. If R is of known value and is replaced by another resistance of the same value, the note will be the same. If the new resistance is higher, note will be lower and if of lower value, the note will be higher. To give an approximation, if the product of C in microfarads and R in megohms is about .001, then a musical note will be heard. For high values of C and R, clicks of discharge frequency can be counted.

PRACTICAL TELEVISION NOV. ISSUE NOW ON SALE PRICE 1s. 3d.

The main feature in this month's issue of our companion paper **PRACTICAL TELEVISION** deals with the construction of a modern switched TV and F.M. receiver. This will consist of a fully detailed constructional article, and in this month's issue the circuit is explained and the preliminary constructional details are given. All the coils in this receiver are home-made.

An Improved Band III converter, utilising two EF50 valves and one EC52 valve is also described.

The location of faults is well covered in this issue, one article dealing with Simplified Servicing, one with the Oscilloscope and TV Servicing, whilst yet another deals with the location of faults by means of a neon screwdriver. The Servicing article in this issue completes the notes on the K.-B. KV35 receiver.

A correspondent reviews some of the exhibits at the Radio Show, whilst the issue is completed with Telenevs, Underneath the Dipole, Readers' Correspondence and Your Problems Solved.

HOME RADIO OF MITCHAM

187 LONDON ROAD, MITCHAM, SURREY. MIT 3282

Exciting Gift for Any Boy or Girl

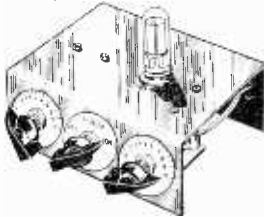

R.E.P. 1 valve all-dry battery set, gives excellent results. Complete kit of parts, including valve, only 33/6. Combined H.T. and L.T. battery, 8/3. Headphones, 14/- . Full constructional details and price list, price 9d.

Loudspeakers for Transistor Sets

Now in stock, the new WB Stentorian mini-speakers. Ideal for personal sets. S.175. Diameter 1 1/2 in., depth 1 in., 3 ohms, 26/9. S.2X3. Elliptical 2 1/2 in. x 1 1/2 in. Depth 1 1/2 in., 3 ohms, 32/- . Full range of REPANCO transistor components in stock, also kits for THREE DEE and TRANSEVEN, details on request.

W.B. STENTORIAN HF1012

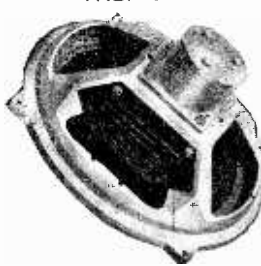

The most popular Hi-Fi speaker on the market to-day. Top quality at realistic cost. 10 in. diecast unit with 12,000 gauss magnet. Response 30 to 14,000 cps. 10 watts handling. Universal speech coil for 3, 7 and 15 ohms.

PRICE £4-19-9 (Plus 2/- post)

We also carry a comprehensive range of WHARFEDALE and GOODMANS Hi-Fi speakers and tweeters, and cross-overs. The amazing LORENZ LPH65 tweeter brings life and realism to your reproduction. Only 39/6 with instructions. Easily connected to your existing speaker through 2 mfd. condenser, 3/- .

THIS MONTH'S BARGAINS

New ELAC miniature output transformers for mains pentode, 4/- , plus 9d. post.
 Single screened microphone cable. Black P.V.C. covered, 6d. yard, plus 1/- post.
 S.130P voltage stabilizers. New in boxes, 3/- each, plus 9d. post.
 New Franklin multiratio output transformers, individually boxed, 5/- , plus 1/- post.
 7 in. x 4 in. elliptical speakers, 3 ohms ELAC, 15/- , plus 2/- post.
 1,200 ft. P.V.C. recording tape. New and boxed. 20/- , plus 1/4 post.

A new JASON F.M. TUNER—THE MERCURY

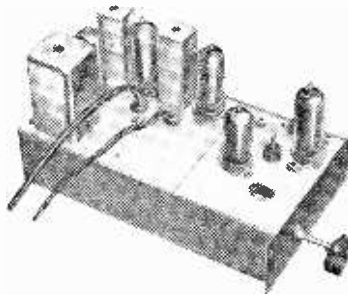

AM/FM Tuner chassis with own power supply. Designed for highest quality reproduction. Built to highest technical standards. Full Specification on request. PRICE £20-17-0. We also carry the other DULCI tuner, receiver and amplifier chassis and the ARMSTRONG PB409 and AF105. Call for demonstration.

CHRISTMAS OFFER

Brand new focusing torches with novel device giving Red, Green or White beam at touch of a button. Ideal for motorists. A wonderful gift for any boy or girl. Takes two U2 batteries. Less batteries ONLY 5/- post paid.

F.M. at its simplest and best. The programme you want at the turn of a switch. Automatic frequency control prevents drifting and the Foster-Seeley discriminator gives top quality. Enjoy crystal clear Hi-Fi reception at all times. Full data and price list 2/- . All parts available separately. Complete kit £10-0-0.

DULCI MODEL H4T

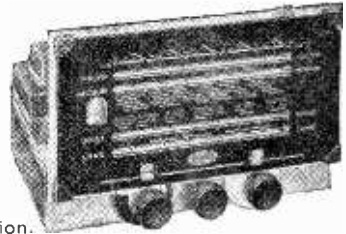

THE HIWAYMAN ALL-DRY PORTABLE



A well-tryed portable, using high efficiency ferrite rod aerial. 2 waveband. 4 valves. Build it during the dark evenings ready for the spring. Full constructional data and price list 1/6. Total building cost £7-10-0.

W.B. STENTORIAN CABINETS

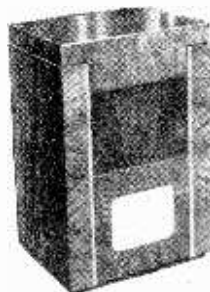

A full range of beautifully-finished cabinets for housing record players, tuners, and amplifiers. PRICES FROM 12 gns. Bass reflex and corner speaker cabinets from 9 gns. Send 3d. stamp for illustrated leaflet, including the new "Prelude" contemporary models. These cabinets are packed flat in cartons and can be quickly and easily assembled using only

a screwdriver. Despatch by return to anywhere in U.K., carriage charge 5/- .

We are stockists for : EDDYSTONE receivers and components, PANDA transmitters, including the CUB and EXPLORER. Also the PANDA G4ZU MINIBEAM.

I.T.A. CONVERTER. All I.T.A. stations, wired ready for use, complete with power pack, fine tuner, etc., £4/7/6, as illus. Metal cabinet, stove enamel grey hammer finish. Walnut cab., £4/17/6. Lizard rexine, £4/12/6. Chassis (less cub.), 77/6. All with two ECC81. All plus 3/- p. & p. (C.O.D. 2/- extra) Clip on I.T.A. aerial to existing mast, or mount in loft. 3 element, 27/-; S.E., 35/-; 8.E., 55/-; low loss coaxial, 8d. yd. Terms on complete converters one-third down and balance, plus 5/-, payable in 4 equal monthly instalments. Postage with first payment

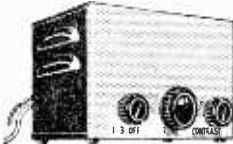

RADIO SET. 4 valves. UY41, UAF42, UL41, UCH42. Covers 4 selected stations; aerial included. 200-250 v. A.C./D.C. mains. Chassis 9in. x 5in. x 2in. high (5½in. over speaker). 5in. P.M. speaker. On-off/vol. 35/- down and 3 monthly payments of £1. Walnut cabinet to fit, 20/-

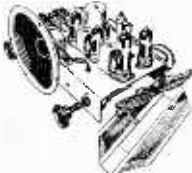

Reduced price due to new purchase £4/10/0 (3/- p. & p.; 2/- C.O.D.)

AUTOMATIC RECORD CHANGERS are in short supply. Collaro RC456 Studio turnover crystal pick-up. 4-speed mixer. A.C mains 200-250 v., see illus. ALSO Collaro single player AC3/554. 3-speed, turnover crystal pick-up with "T" head. £6/16/6 (3/6 p. & p.).



£8/16/6 (5/- p. & p.)

GLADSTONE RADIO

HIGHLY SUCCESSFUL 13-CHANNEL CONVERTER.

Designed and made by a world-famous organisation regardless of expense. Tunable over the whole of Band I and Band III to give one Band I and two Band III stations at the turn of the switch Acts as Two-valve Pre-amplifier on Band I. Valves PCC84 and PCF80. No drift. In Moulded Bakelite Cabinet, 8½in. x 4½in. x 6in. high. With full operating instructions. Built-in Power Pack added by us. Separate gain controls for I.T.A. and B.B.C. (P. & p. 3/-, C.O.D. 2/-.)



£5-5-0

AS ABOVE LESS POWER PACK 72/6 (P. & P. 3/-) CONVERTER available for Philips receivers to above specification complete with built-in power pack, at £5/5/- P. & p. 3/-.

ELECTROLYTICS 25 mf. 25 v. tub. wires, 9d.; 12-12 mf. 275 v. tub. wires, 2/3; 32-32 mf. 350 v., 1½in. can, 3/-; 200 mf. 6 v. ¼in. can, 9d.; 16-24-9 mf. 350 v., 1½in. can, 3/-; 100-200 mf. 275 v. can, 7/6.

MAINS TRANSFORMER. 290.0-290 v. 60 m.a., 6.3 v. 2½ A. and 6.3 v. 1 A., 12/6 (p. & p. 3/-).

BATTERY ELIMINATOR. 90 v. 15 m.a. and 1.4 v. 125 m.a. for 4 low consumption valves; 5½in. x 3½in. x 2in. for 200-250 v. input. 35/- (p. & p. 2/6).

SMALL QUANTITY I.T.A. converter chassis by one of our largest manufacturers for London and Winter Hill areas only, valve rect. & ECC81 & PCC84; with power pack, and direct switching I.T.A. to B.B.C. Chassis size 8in. x 5½in. x 4½in. ONLY 70/-; Walnut cab. 10/- extra.

Ex-W.D. PERISCOPIES, fixed, giving rise of 10in. Price 4/6 (p. & p. 3/-).

ALL NEW GOODS; POSTED ORDERS TO CAMBERLEY, PLEASE.

3 CHURCH RD., REDFIELD, BRISTOL AND 82b HIGH STREET, CAMBERLEY, SURREY

BUILD THIS AUTHENTIC

JASON SWITCHED F.M. TUNER

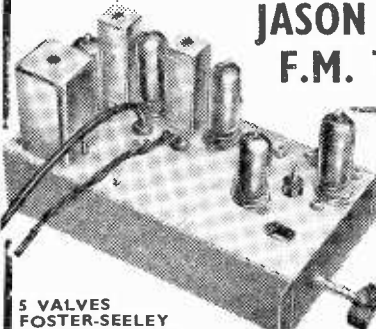

JASON MERCURY

5 VALVES FOSTER-SEELEY DISCRIMINATOR

When built, this new Jason F.M. Tuner provides choice of the three B.B.C. programmes at the turn of a switch, with a fourth position for "OFF." It is a stable unit, free from drift and of high quality. The Switch Tuned Front End is supplied wired, tested and aligned, complete with 2 valves and station-indicating plate. Chassis ready punched. In conformity with all Jason F.M. Units, this model is completely stable and offers the highest possible standards of reproduction.

CONSTRUCTOR'S SWITCH-TUNED KIT including assembled Front End with two valves and all parts as specified and priced. **£9.0.0**

SWITCH-TUNED FRONT END with two valves, complete. **£6.5.0**

(incl. £1 15 0 P. Tax.)

Data Publication Book of the Tuner (Post Paid 2/-)

JASON POWER PACK KIT £2.1.9

FROM LEADING STOCKISTS, or in cases of difficulty:

THE JASON MOTOR & ELECTRONIC CO. Phone: SPE 7050
328, Cricklewood Lane, London, N.W.2.

GUARANTEED VALVES

CV6	1/-	EL32	6/6	PZ30	16/-	SAB8	9/-	GP28	20/-
DF91	7/6	EL33	15/-	RK34	3/6	6A7C	6/6	6Q7	8/6
DET119	1/6	EL38	22/-	RL37	5/-	6A8J8	5/-	6R7	7/6
DET25	5/-	EL41	10/-	SF61	5/-	6AK9	8/6	6SA7	8/-
DF14	7/6	EL42	10/-	TT11	10/-	6AC5	6/6	6SH7	7/6
DL92	7/6	EL99	7/-	LB01	20/-	6AK5	6/6	6SJ7	7/6
DL93	7/6	EL91	8/6	UBC41	10/-	6A15	6/6	6SK7	7/6
DL95	7/6	EN91	7/6	UB41	10/-	6AM6	7/6	6SL7	6/6
EA50	1/-	EY51	11/6	UCH42	10/-	6AQ5	7/-	6SN7	7/6
EALC63	9/-	EZ73	8/-	UF41	10/-	6AT6	8/-	6SS7	7/6
EB31	2/6	EZ40	8/-	UP42	10/-	6A16	7/6	6V6	7/6
EB91	6/-	EZ81	8/6	UL41	10/-	6BA6	8/6	6X4	7/6
EBC33	10/-	EZ90	7/6	U8	20/-	6BE6	8/-	6X5	7/6
EBC41	10/-	FC13C	7/6	UY41	8/-	6BF6	8/6	6D2	4/6
ECB91	8/-	KT33C	8/6	VP13C	4/6	6BH6	7/6	12A6	7/6
EBP80	9/-	KT44	7/6	VR116	6/-	6BS7	8/6	12A18	10/-
ECC81	9/-	KTW63	7/6	VR150-30	7/6	6BW3	7/6	12AX7	8/6
ECC82	9/-	PL38	52/-	VU111	2/-	6B8	5/-	12AU7	9/-
ECC83	9/-	PL81	10/6	X65	10/6	6C4	6/-	12AX7	9/-
ECC84	11/-	PL82	10/6	IL4	7/6	6CH6	8/6	12BH7	8/6
ECG91	7/-	PL83	10/6	IT4	7/6	6F32	5/-	12C8	1/-
ECH35	10/-	PY80	9/-	10Q6	7/6	6F83	7/6	12DE6	9/6
ECH42	10/-	PY81	8/6	IU5	7/6	6G6	5/-	12J5	5/6
ECH81	9/-	PY82	8/6	2C31	3/6	6H6	2/6	12J7	7/6
ECF82	11/-	PCF80	10/-	DD21	7/6	6J5	5/-	12K7	7/6
ECL80	9/-	PCF82	10/-	2X2	4/-	6J6	7/-	12K8	17/-
EC52	5/-	PC84	11/6	3A4	7/6	6K7	5/6	12K7	7/6
EC54	5/-	PCL82	10/-	3Q4	7/6	6S8	7/6	12SK7	7/6
EC90	6/-	Pen48	8/6	4D1	4/6	6L6	10/-	12SG7	5/-
EF38	6/-	PC183	10/-	5U4	8/-	6N7	7/6	12SH7	5/-
EF37A	10/-	PG1	5/-	5Z4	10/6	6N8	9/-	12SJ7	5/-
EF39	6/-							12SK7	5/-
EF41	10/-							35Z4	8/6
EF42	10/-							58	6/6
EF43	5/-							58	5/-
EF54	7/6							76	5/-
EF80	8/6							85A2	10/-
EF85	10/6							80C1	8/-
EF91	7/6							807	7/6
EF92	5/6							832	40/-
EF93	8/6							954	5/-
EF94	7/-							955	5/-
EF95	6/6							7193	5/-
EF96	6/6							8012	10/-
EK90	8/-							1003	5/-

MEGGER TYPE OHMMETERS, with scale 0 to 10 K., hand generator and Brand new. £4 ea., or with new leather carrying case, £4.10. Post free.

18" SETS. Still available at £5 with power unit and brand new. 12.6 C. and P.

CO-AXIAL CABLE. Standard 75 ohm. 8d. yd. Airt spaced at 9d. yd. Cheaper quality at 6d. yd.

Post & Packing 6d. Free over £1. C.O.D. 2/6 extra.

LAWRENCE ELECTRONICS
15B, CHIPSTEAD VALLEY ROAD, COULSDON, SURREY.
UPLands 9075. Open to personal callers on Saturdays only.

All About Microphones

AN EXPLANATION OF TYPES AND USES

By J. Brown

THE carbon mike is probably the cheapest on the surplus market, in various forms from button to the Post Office insert type as used on telephones. The latter seem to be in the majority, giving reasonable quality on speech, the response being roughly 200-4,000 cycles per second. The output is quite high, but it has many disadvantages, these being (1) Limited response. (2) Rather noisy in operation, due to the carbon granules (we have to give the mike a shake at intervals to free the granules). (3) Needs

30-10,000 cycles per sec. This is very good indeed, but the output voltage is very low, and we either need a very high gain amplifier or a high gain pre-amplifier stage before feeding to the apparatus with which we intend to use the mike. A circuit, Fig. 6, is given which has sufficient gain for this purpose: the power supply can come from the main amplifier. The quality from this type of microphone is first-class if we have enough gain in the main amplifier. Type 2 of the crystal mikes is the diaphragm mike. As Fig. 5 shows,

the crystal cell is fitted to the main body of the microphone, and the little diaphragm is connected to the crystal, similar to the cone on a loud-speaker. This cone collects the incoming sound and vibrates the crystal. The response is slightly lower than the floating cell type, roughly between 40-6,000 cycles per second. Due to the collective action of the diaphragm the output of the mike is quite high and may be fed direct to any reasonably high gain amplifier. There are, however, on the market, as surplus, a large number of crystal inserts. These are actual microphones, being surplus from the well-known Government Medresco hearing aid so far as the

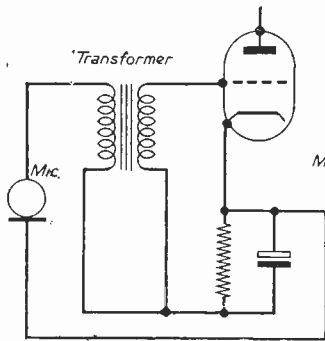

Fig. 1.—Cathode bias is used here as the polarising voltage for a carbon mike.

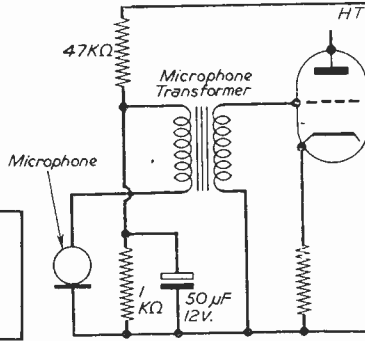

Fig. 2.—A potential divider across the H.T. supply furnishes the polarising voltage here.

a D.C. voltage to polarise the mike, this being 3-8 volts. (4) Needs a transformer with a step-up ratio of 60-1, preferably screened.

The biggest drawback is the D.C. voltage supply. We could, however, use a battery externally. This is most inconvenient, so we give three ideas for obtaining this D.C. supply from the main amplifier. Figs 1, 2 and 3 are the easiest ways and they may be built into a circuit.

Fig. 1 shows the supply from the cathode of the 1st audio amplifier, making use of the voltage developed by the bias resistor. Fig. 2 shows the voltage being extracted from a potential divider across the main H.T. D.C. supply, the resistors being about 4 watts. Fig. 3 shows the voltage being borrowed from the cathodes of the output valves, two in push-pull, the voltage being variable by adjusting the 10K resistor. These are all practical ways of obtaining this required voltage, and have all been used with success.

Crystal Mikes

These are in two categories. 1. The floating cell type (Fig. 4), where the crystal cell is suspended inside the mike housing by rubber bands; and 2. the diaphragm type (Fig. 5), where there is a cone fitted to the actual crystal. We have given sketches of these two types. The first mentioned, the floating cell type, is the most expensive, giving a frequency response of

about 80 to 6,000 cycles, the main accent on the sibilants, letters like S, T, V, etc., that have a higher frequency than letters like the vowels, so with some tone correction these can be used very successfully. A circuit for the tone correction is given in Fig. 7. This can be fitted as part of the circuit, or a value of condenser suitable is selected and fitted. In all cases of using a crystal mike we must have a grid resistor of 1-5 megohms, the lower values giving a slightly less bass response. Again we can suit our individual needs. Before passing on, we should point out that a crystal mike is excellent

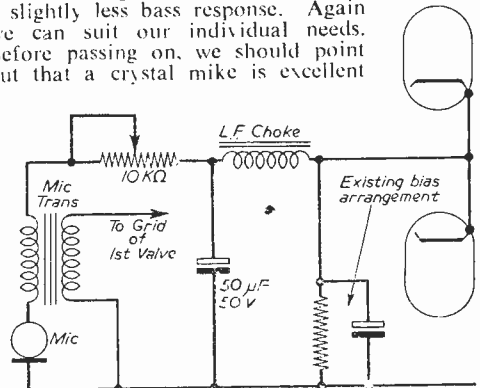

Fig. 3.—Another polarising circuit.

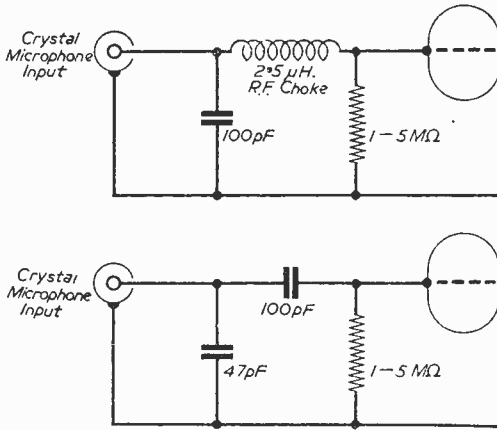
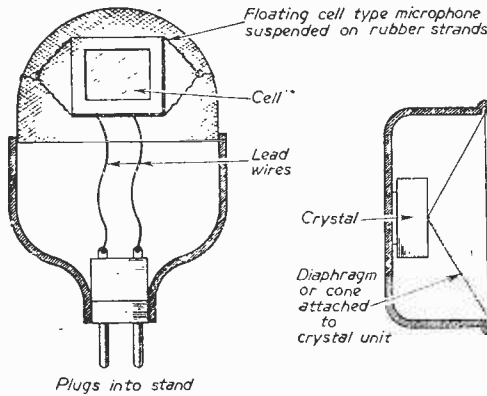

Fig. 9.—Two further matching circuits for a crystal mike.

but fragile and must not be abused, and always handled with care, as the crystals will easily fracture. The common symptom is loss of gain: Should this occur the answer is to return them to the manufacturer, as crystals cannot be repaired successfully.

Moving-coil Mikes

These are far from being unpopular, and are again available on the surplus market. Again we need a step-up transformer, the ratio being 100:1 step-up. One essential factor when using a moving-coil is



Figs. 4 and 5.—Two alternative forms of crystal mike construction.

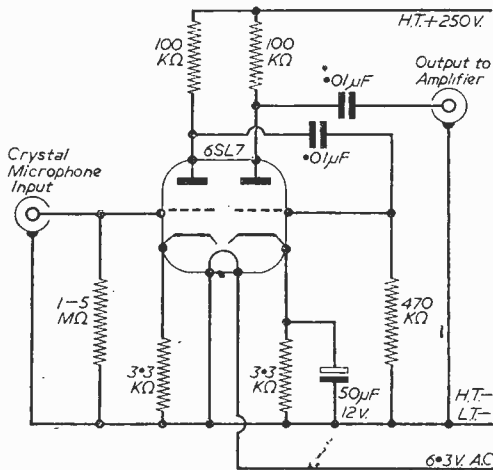

Fig. 6.—A pre-amplifier using a double-triode.

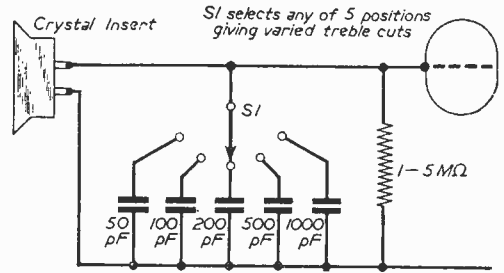
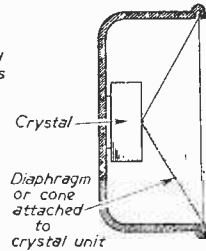

Fig. 7.—A tone correction circuit.

complete shielding of leads and transformer, as hum is very easily introduced. One side of the primary and secondary must be earthed to chassis at the same point, the grid lead to be also screened. As Fig. 8 shows, all leads, etc., are screened, also the mike lead. A moving-coil mike used on a high gain amplifier, if unscreened components are used, can be a real hum maker, and it is better if the amplifier is also earthed, then it should be hum free.

Transverse Current Mikes

These are little used these days and may be treated with the similar characteristics as the carbon mike. Ribbon mikes are, however, a different proposition. These require a considerable amount of gain, but the quality of 100 per cent. The price ranges from £8-£50, and they are made in different value outputs from 20 ohms to a value which will match into



the grid. Most ribbon mikes have a transformer built in at the bottom of the case, to bring the impedance of the ribbon to a value which is easier to handle, as the impedance of the ribbon itself without this transformer is very low.

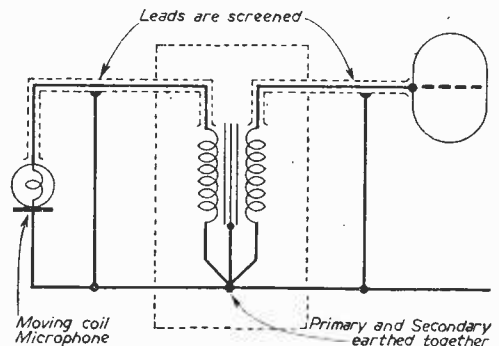
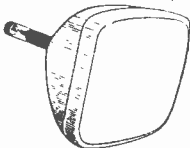

Fig. 8.—Note the screening which is needed with a moving-coil mike.

TELEVISION TUBES

COMPLETE RECTANGULAR T.V. TUBES



12 MONTHS' GUARANTEE

17" £7.10.0. 14" £5.10.0

6 months full replacement 6 months progressive. Made possible by the high quality of our tubes. Ins. carr. 15/6.

SPECIAL OFFER OF 14" 15" 16" T.V. TUBES £5

Convert your 9in., 10in., 12in. to the above sizes. Details on how to "Do-It-Yourself" in our FREE Catalogue. 12in. T.V. Tubes £5. Guaranteed. 15/6 ins., carr. on all tubes. Also T.V. Tubes with burns from 15/-. State type and size required. Ins. carr. extra.

17" T.V. CHASSIS £19.19.6



Latest improved circuits. Higher E.H.T. (brilliant picture). Improved sensitivity (for greater range). Chassis easily adapted to any cabinet. 17in. rectangular tube on adapted chassis. All channels. TURRET TUNER 50-extra. Valve line up (5 valves): 6X5N7G, 6V6, EY51, 2-6D22. Others: 6L18, 6L38, 7-6P1s. Chassis size 11 1/2in. x 14 1/2in. x 11in. 12 MONTHS GUARANTEE on tube. 3 months guarantee on valves and chassis. All channels. Less valves. With 5 valves £21.19.6. With all valves £25.19.6. Ins. carr. 25/- (incl. tube). Slate B.B.C. channel (and I.T.A. if turret tuner required).

14" T.V. CHASSIS, TUBE AND SPEAKER £13.19.6

As above with round type tube. Modified ready working. Less valves. 3 months guarantee. With 5 valves £15.19.6. With all valves £19.19.6. Ins. carr. 25/- (incl. tube). Turret Tuner 50/- extra.

BEAUTIFUL EXTENSION SPEAKERS 29/9

Complete fitted with 8in. P.M. Speaker "W.B." or "Goodmans" of the highest quality. Standard matching to any receiver. (2-5 ohms.) Flex and switch included. Unrepeatable at this price. Money refunded if not completely satisfied. Ins. carr. 3/6.

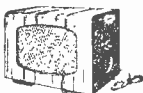

ELECTRIC CONVECTOR HEATER 99/6

Cleaner, cheaper, safer than paraffin. A.C. D.C. Switched for 1 or 2k watts. Illuminated grille. Ins. carr. 10/6.



ELECTRIC FIRES 17/6

Hammered finish. A.C. D.C. 200-250 volt. 750 watt. Post 3/6.

PORTABLE ELECTRIC FIRES 27/6

Penic element. 1 k watt, beautiful finish, reflector type. A.C. D.C. 200-250 volt. Post 3/6.

ARGOSY PUSH PULL R/GRAM CHASSIS 139/6

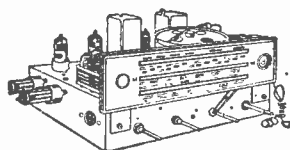

Valves: 2EBF80, 2EL42, ECH81, EZ80, EBC41, EM34.

8 valve latest models. 3 wband and gram. switched. Over 10 watts output. Full tone range. 4 knob control. Size: 14in. x 9in. x 7 1/2in. Less valves. Ins. carr. 5/6.

HOME RADIO 79/6

5 valve (octal), superhet. 3 wave-band receiver. A.C./D.C. Universal mains can be adapted for gram. P.U. in wooden cabinet. 18 1/2in. x 11 1/2in. x 8 1/2in. Ins. carr. 7/6.

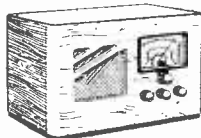

CONSTRUCTOR CHASSIS UNITS

POWER PACK AND AMPLIFIER 19/6. O.P. stage 6V6 with O.P. trans. Smoothed H.T. 350 v. 250 mA., 6.3 v. 5 a., 22 v. 3 a., 6.3 v. 4 a., 4 v., centre tapped. Less valves. FREE drawing. Carr. 5/6.

TIMEBASE 7/9. Including scanning coil locus unit, etc. Less valves. FREE drawing. P. & P. 2/6.

SOUND & VISION STRIP 19/6. S'het. Complete's vision strip. Less valves. FREE drawing. P. & P. 2/6.

POPULAR RADIO OR R/GRAM CHASSIS 39/6

3 wband and gram. S'het. 5 valve. International Octal. Ideal table gram, but still giving high quality output. 4 knob control. 8in. P.M. Speaker 7/9 extra. set of knobs 2/-. Chassis size 15 1/2in. x 9in. x 6 1/2in. Less valves. Ins. carr. 4/6.



MAINS TRANSFORMERS

350-0-350 v. 80 mA. 4 v.-4 v. heaters. 200-250 v. Prim. ... 3/9

350-0-350 v. 80 mA. 12 v.-4 v. heaters. 200-250 v. Prim. ... 2/9

250-0-250 v. 80 mA. 6 v., 4 v., 4 v. 200-250 v. Prim. ... 5/9

Drop through type. Half shrouded. All above 2/3 post. 425-0-425 v., 5 v. 6 a., 6.3 v. 12 a., 6.3 v. 6 a., 200-250 v., 17/6. Screened primary. P. & P. 2/6.

O.P. TRANSFORMERS 1/3. Standard size (2.5 ohms). Post 1/-, 20 for £1. P. & P. on 20. 5/6.

CO-AX CABLE. Ed. yd. Good quality. Cut to any length. 1/6 post on 20 yds., 45/- per 100 yds., post 3/6.

Boxed VALVES 3 MONTHS GUARANTEE

1A5	2/9	6N7GT	4/9	CV18	3/9	EF37	4/9
155	4/9	6S67	3/9	DF83	5/9	EF41	8/9
3A3	3/9	77	3/9	EB34	1/9	EF50	2/9
4D1	2/9	8D3	3/9	EBC1	6/9	EL32	6/9
6B8	3/9	8D3	3/9	ECC81	8/9	EL91	3/9
6F12	7/9	12AU7	5/9	ECH32	8/9	PEN45	6/9
6D2	6/9	12BE6	6/9	EF38	6/9	TT11	6/9
6HM	1/9	12SC7	1/9	EF11	8/9	X66	3/9
6K7	2/9	12S37	1/9	EP91	7/9	Z77	7/9

American Types. U.X. All at 3/9 each.

18	75	80	25RE
42	78	1D6	6A7
		6D6	6CS

Barretters 361 and 302 also at 3/9 each.

8in. P.M. SPEAKERS, 8/9. Let the lady of the house listen to that T.V. or radio programme. Complete with O.P. trans., 10/- P. & P. 2/8.

P.M. SPEAKERS, 12/9. Elac. or Goodmans. High quality. 2-5 ohms. Complete with O.P. trans. 14/- P. & P. 2/9.

COIL PACK SETS, 3/9. This bargain includes 3 band coil pack, pair 455 I.F.s std. 2-gang condenser. Printed dial. P. & P. 2/3.

HEADPHONES, 1/9. Single earphone and headband. C-LR type. Ideal for crystal sets, extension on radio, etc. P. & P. 1/3.

Terms available

Liverpool St.—Manor Park—10 minutes.

Send for our FREE 1958 catalogue.

Open Saturday all day.

DUKE & CO. (Dept. 4), 621/3, Romford Road, Manor Park, E.12.

Tel.: Ilford 6001-3

COLLINS TCS TRANSMITTERS. Special offer of these famous American Transmitters. Frequency Range 1.5-12.0 Mc/s in 3 bands. Employs 7 valves, 2 of 1625 in P.A. Stage, 1625 buffer and 1625 modulator stage, 3 of 12A6 in Oscillator stage. Radio Telephone or Radio Telegraph. Provision for VFO or Crystal Control. 4 Crystal positions. Has Plate and Aerial Current meters. IN BRAND NEW CONDITION. ONLY £12.10.0 (carriage, etc., 15/-).

WIRELESS SET NO. 19 Mk. II.—The famous Army Tank Transmitter-Receiver. Incorporates "A" Set (TX/RX covering 2.0-9.0 Mc/s, i.e., 37.5-150 metres), "B" Set (VHF TX/RX covering 230-240 Mc/s, i.e., 1.2-1.3 metres) and Intercommunication Amplifier. Complete with 15 valves as follows: 6 of 6K7G, 2 of 6K8G, 2 of 6V6G, and 1 ea. 6B8G, 6H6, E1143 EF50, 807, and booklet giving circuits, notes, etc. Size 17 1/2 in. x 8 1/2 in. x 12 1/2 in. Magnificently made by famous American firms. IN BRAND NEW CONDITION. ONLY 65/- (carriage, etc., 10/6). **12 VOLT POWER UNIT** for the above available, 25/- (carriage, etc., 5/-).

MARCONI SIGNAL GENERATORS TF-390G. Frequency coverage 16-150 Mc/s. BRAND NEW IN MAKER'S ORIGINAL TRANSIT CASES, with instruction manual. For normal A.C. mains operation. A unique opportunity to acquire Laboratory Equipment at a fraction of original cost. ONLY £27/10/-.

MARCONI BAND III CRYSTAL CALIBRATORS. Frequency range 170-240 Mc/s. Incorporates 5 Mc/s crystal for better than .001 per cent. accuracy. Directly calibrated dial, internal A.C. mains pack. Complete with spare set of valves and instruction manual in maker's transit cases. BRAND NEW. ONLY £4/19/6.

POWER UNIT TYPE 3. Primary 200/250 v. 50 cycles. Outputs of 250 v. 100 mA. and 6.3 v. 4 amps. Fitted with H.T. current meter and voltmeter. For normal rack mounting and has grey front panel size 19 in. x 7 in. ONLY 70/- (carriage, etc., 7/6).

6 v. VIBRATOR PACKS. Output approx. 130 v. at 30 mA., fully filtered and smoothed. Complete. ONLY 12/6.

RII55 SUPER SLOW-MOTION TUNING ASSEMBLY. As used on all late model 1155s. Easily fitted to "A" sets, etc. ONLY 12/6.

RF UNITS TYPE 26. Similar in all respects to RF UNIT 27 required for "Practical Wireless" FM FEEDER UNIT, with exception of Frequency Range. Covers 65-50 Mc/s (5-6 metres). Complete with valves, and BRAND NEW IN MAKER'S CARTONS. ONLY 25/- each.

CLASS D WAVEMETER. Another purchase of this famous crystal-controlled wavemeter which has been repeatedly reviewed and recommended in the "R.S.G.B." Bulletin, as being suitable for amateur transmitters. Covers 1.9-8.0 Mc/s, and is complete with 100/1,000 kc/s crystal, 2 valves ECH35, two 6-volt vibrators and instruction manual. Designed for 6 v. D.C. operation, but simple mod. data for A.C. supplied. BRAND NEW IN MAKER'S TRANSIT CASES. ONLY £5.19.6. Transformer for A.C. modification, 7/6.

EHT TRANSFORMERS. 5.5 kV. (Rect.) with 2 v. 1 a., 79/6. 7 kV. (Rect.) with 2 v. 1 a., 89/6. 2.5 kV. (Rect.) with 2-0-2 v. 1.1 a., 2-0-2 v. 2 a. (for VCR97 tube, etc.), 42/6 (postage 2/- per trans.).

L.T. HEAVY DUTY TRANSFORMERS. Ex-Admiralty, with 230 v. 50 cycles primary. Secondaries 5, 10, 15, 20, 25, 30 volts at 5 amps. ONLY 29/6. (Postage 2/9).

INSULATION TESTERS (MEGGERs). Read up to 20 megohms at 500 volts pressure. Overhauled and in perfect order ONLY £8.10.0.

A.C./D.C. BLOWERS, 220/250 volts 300 watts Complete with filter pads, branch for dividing outlet, flexible hoses, etc. BRAND NEW ONLY £4.19.6.

POCKET VOLTMETERS.—Read 0-15 volts and 0-300 volts A.C. or D.C. BRAND NEW AND UNUSED. ONLY 18/6.

WALKIE TALKIE TYPE 18. Covers 6.0-9.0 Mc/s. Transmitting and receiving units in metal case, complete with valves. In excellent condition. ONLY 79/6.

CRYSTALS. British Standard 2-pin 500 kc/s, 15/-; Miniature 200 kc/s and 465 kc/s, 10/- each.

U.E.I. CORPORATION

138, Cray's Inn Road, London, W.C.1 (Phone: TERminus 7937)

Please include carriage costs on ALL items.

(Open until 1 p.m. Saturdays. We are 2 mins. from High Holborn (Chancery Lane Station) and 5 mins. by bus from King's Cross.)

HANNEY

offers

Components for

OSRAM 912 PLUS AMPLIFIER
OSRAM 912 PASSIVE UNIT
OSRAM 912 PRE-AMPLIFIER
OSRAM F.M. PLUS TUNER

MULLARD 510 AMPLIFIER
MULLARD 510 "A" PRE-AMPLIFIER
MULLARD 510 "B" PRE-AMPLIFIER
MULLARD 3/3 AMPLIFIER
MULLARD F.M. TUNER UNIT

"WIRELESS WORLD" F.M. TUNER UNIT
DENCO MAXI-Q F.M. TUNER UNIT

Manuals available:

912 PLUS AMPLIFIER—4/-; OSRAM F.M. PLUS TUNER—2/6; MULLARD HIGH QUALITY AMPLIFIER MANUAL (contains F.M. details)—3/6; DENCO F.M. TUNER—1/6.

Send 3d. postage, stating lists required. General Components list also available.

L. F. HANNEY

77, Lower Bristol Road Bath

RST

MAIL ORDER DEPARTMENT
211 Streatham Road, Miteham, Surrey.
ALL VALVES LISTED ARE NEW STOCK. CASH WITH ORDER
AND POST FREE. MITCHAM 6201

AZ1 11/3	EF9 21/-	MKT45	UC683 23/8	6F13 21/-
B65 12/4	EF22 10/3	6or 7 21/-	UF41 11/-	6J5G 5/-
D41 8/-	EF37A	8P41 12/8	UF80 12/6	6J7GT 9/-
DAC2 9/6	10/6	MU14 10/-	UL41 10/-	6K7 8/-
DAP91 9/-	EF4 15/-	N47 15/9	UL84 11/-	6K8GT 12/-
DAP96 9/6	EF41 9/-	N78 11/8	UC8 24/8	6L1 12/6
DF31 9/8	EF42 12/6	N142 10/-	UY41 7/6	6L6G 12/-
DF97 9/-	EF50 8/6	N153 11/4	UY85 7/6	6L18 12/6
DF929 8/-	EF53 9/8	N154 11/4	VP2B 13/6	6L19 15/-
DF91 8/9	EF86 12/6	N727 8/-	W17 7/-	6M3 7/-
DF96 9/-	EF89 11/6	PCS4 9/-	W77 12/-	6N17GT 7/6
DH719 9/8	EF91 8/6	PCF80 12/6	W81M 15/-	6N7GT 8/-
DK32 12/3	EF92 9/6	PF082 11/6	W142 11/-	6U4GT 11/8
DK91 9/-	EF95 14/-	PCL82 12/-	W719 9/6	6X4 8/-
DK92 11/6	EL28 24/6	PCL83 18/6	W727 8/6	6X5GT 9/6
OK96 10/-	EL41 10/-	PL46 15/-	X18 11/6	7R7 13/-
DL23 9/6	EL42 9/-	PL38 24/8	X78 19/-	787 14/-
DL82 9/-	EL81 12/6	PL82 10/-	X79 11/6	7Y4 9/6
DL92 8/-	EL84 9/-	PL83 11/4	Z21 10/8	813 8/6
DL94 8/9	EL80 10/-	PL83 11/4	Z27 8/6	10C1 15/10
DL96 8/9	EM89 10/6	PM80 8/3	Z152 8/6	10C2 19/6
DW4500	EM81 11/6	PM81 9/6	Z719 8/6	10F1 24/6
11/8	EM85 15/6	PM82 3/-	ZD152 9/-	10L D11
EAB680 9/3	EY4 11/6	PM83 9/-	1C2 11/6	14/9
EAC91 10/9	EY41 10/-	PZ99 25/-	1P5 7/-	10P15 17/6
EAF42 10/3	EY84 13/6	R89 20/6	1P5 9/6	12A5 11/4
EB41 10/6	EY91 9/-	R19 18/-	JT4 8/9	12A7 8/6
EB91 5/9	EZ35 9/6	8P41 11/6	5U4G 10/8	12A77 9/-
13BC41 9/3	EZ40 8/6	8P61 3/6	5Y8GT 9/6	12A77 9/9
13BF89 9/-	EZ41 10/6	TD14 17/8	5Z4G 10/8	12AX7 10/-
13BF99 9/6	EF89 8/6	TP22 10/8	6ACGT 14/-	12BA6 8/8
EB121 21/-	EZ1 8/-	TP22 18/-	6AL5 5/9	12BB6 9/6
EB131 21/-	EZ99 7/6	U16 11/6	6AM6 8/6	12BH7 11/-
EC91 8/8	EC2 13/-	U25 13/6	6AN5 5/6	12J7 9/6
EC93 10/6	PC18 14/6	U74 7/6	6AQ5 8/-	12K7GT 10/8
EC40 13/-	PC19 10/-	U142 7/6	6AT9 8/3	12K7GT 10/8
EC81 9/-	GZ2 11/8	U145 7/6	6B8 4/-	12KS2 12/-
EC82 9/9	H30 4/9	U147 9/6	6B8A 8/6	12Q7 10/8
EC83 10/-	H63 10/6	U153 8/6	6B8G 8/3	12Q7GT 10/8
EC984 10/9	HLB90 8/6	646 9/6	6B8J 7/6	12Q7GT 10/8
EC985 9/9	HL92 11/8	U94 8/-	6B8T 14/-	14H7 10/8
EC989 12/6	HL139 9/6	UC81 20/6	6B8V 8/4	15D1 14/-
ECF82 14/6	HL139 11/6	UABCS9	6B8W 8/6	15D1 14/-
ECB21 21/-	HY90 7/-	10/-	6B8X 8/6	20E2 21/-
ECB55 12/6	KB63 10/-	UAF42 10/8	6C06G	20L4 15/-
ECF42 9/-	KB30 12/6	UBC41 8/-	27/-	50F5 12/6
ECF61 9/-	KF51 17/6	UBF80 11/6	6I2 5/9	53W1 7/6
ECF89 9/8	LZ31 8/9	UCH42 10/8	6P1 24/6	33Z1 8/6
ECF82 21/-	ML1 8/9	UCH41 10/6	6P12 8/8	60L5 11/-

Quotation given for all types not listed. Obsolete and old types a speciality, send for lists.

Converting the COMMAND RECEIVER

MODIFICATIONS OF THE BC455 FOR
DX USE By R. E. S. Coulson

(Continued from page 608 November issue)

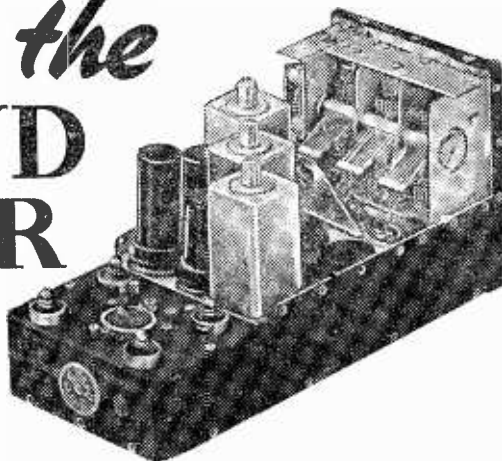

THE output transformer has an output impedance of 4,000 ohms, so will feed nicely into a pair of H.R. phones. (Try this and you will see the need for two potentiometers.) If, however, it is desired to use a loudspeaker, it is preferable to feed the output into an amplifier, which may consist of a 6V6.

Addition to RF24

The set thus modified, when connected to a suitable power supply (12 volts .9 amps, 300 volts 60 mA) is an excellent receiver for the 40-metre band; many British and European amateur and short-wave broadcast stations can be heard with it. It can be

worked also on the most useful DX bands, 10 and 15 metres, by the addition of the RF24. This comes supplied with three valves, SP61s (6.3 volts) and ready to work. All that needs to be done is the wiring up.

At the rear of the RF24 will be found a six-pin Jones plug. The power leads (carrying 6.3 volts 1.8 amp. and 200 volts 10 mA) and the I.F. output are taken through this plug. Connections are given on the circuit diagram (Fig. 3). The I.F. output is taken by about 1ft. 6in. of coaxial to the aerial terminal on the BC455. The coaxial socket on the front of the RF24 may be left, or replaced by a "drop-through"

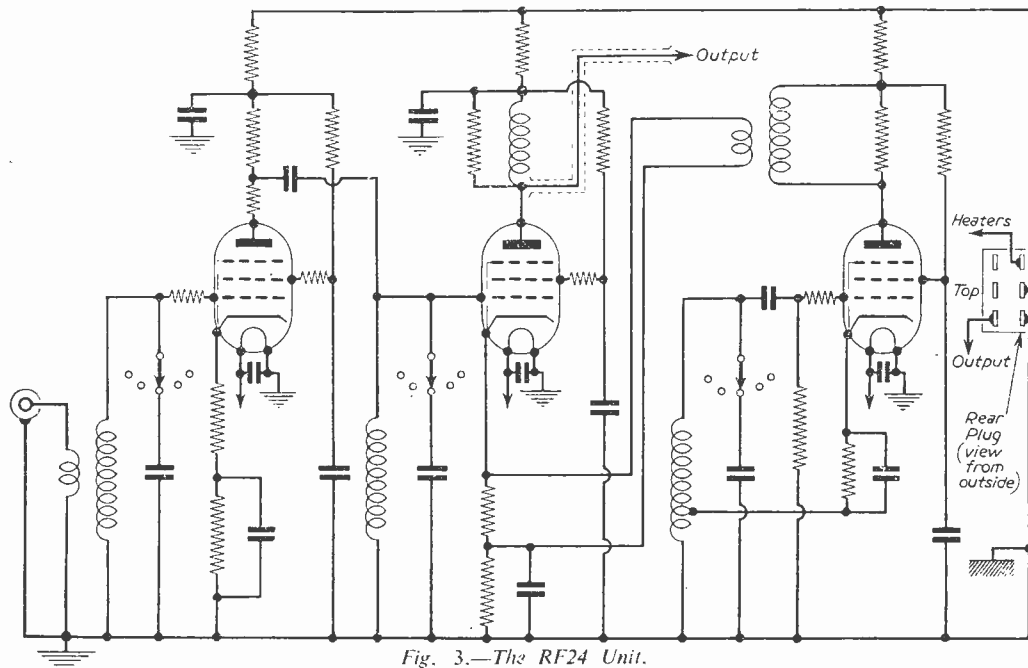

Fig. 3.—The RF24 Unit.

type of normal coaxial socket. A dipole aerial is then connected to the RF24 via the coaxial socket, the power switched on, and the RF24 switched to range 5. The BC455 is then tuned patiently from 7 to 9 Mc/s (over the 10-metre band). When a station is found, the trimmers of range 5 are adjusted to peak it up. The 15-metre band is explored in the same way, with the RF24 switched to range 1, and the BC455 tuned from about 8 to 8.5 Mc/s.

Aerials

Any short-wave receiver performs best on an aerial which has been cut for the band in use. The command set is no exception, and so if one has enough space one can erect some aerials of very high efficiency. The ideals are an aerial for each band, 10, 15 and 40 metres. A fairly good substitute is a dipole for 10 and a 66ft. top for the other two. As an alternative one could press into use the domestic television aerial, or the one normally employed for the reception of the BBC F.M. signals.

It would perhaps be as well to study the article which begins on page 725 in this issue.

Performance

As already mentioned, signals have been heard from many countries, both on C.W. and phone. The sensitivity seems to be better than a lot of factory made receivers, as I have heard amateurs discussing conditions over the air and saying that "the ten metre band seems to be bad": on turning to that band I usually find it "wide open" and have heard some of my best D.X. then. One day I heard a GB2 calling CQ on top of a QRP CN8, also calling CQ DX. That GB2 has a well-known commercial short-wave receiver and lives only about 12 miles away from me.

Additional Notes

It may be found that the gain of the RF24 is too high, in which case a third gain control may be fitted. This is best carried out by removing the name plate of the RF24 and cutting a $\frac{3}{8}$ in. hole in the front panel where it was fixed. It should have a value of about 10K Ω .

It is regretted that we are unable to suggest any further modification in the case of this particular receiver.

LIST OF PARTS FOR FIG 2 (d)	
C23—180pF	C35—750 pF
C38—17 pF	R14—100 K Ω
C24—200 pF	R15—20 K Ω
C15C—.05 μ F	R16—100 K Ω
C26—100 pF	R17—100 K Ω
C27—335 pF	R18—510 K Ω
C28—34 pF	R19—100 K Ω
C29—.006 μ F	R20—2 M Ω
C30—.15 μ F	R21—1.5 K Ω
C20B—.01 μ F	

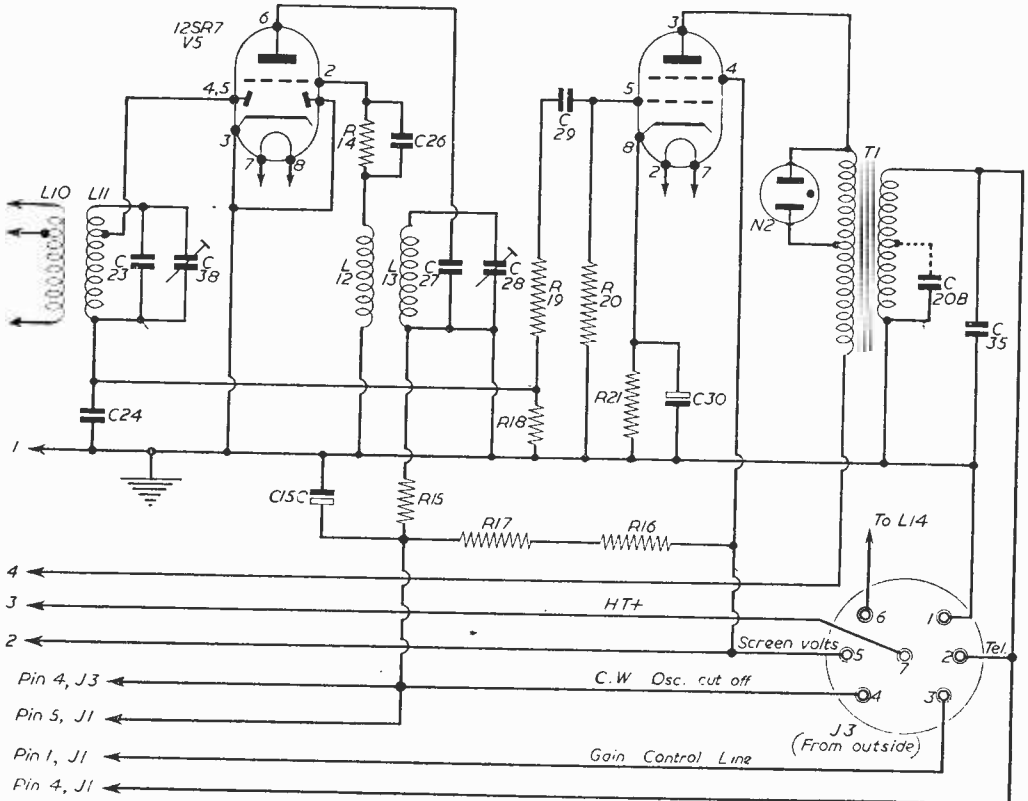

Fig. 2 (d).—Detector, B.F.O. and output stage. A list of parts is repeated above, for this section.

RETURN-OF-POST SERVICE

NEW JASON "MERCURY" FM SWITCHED TUNER KIT

Three switch positions—BBC Light, Home & Third.

This fine new kit gives superb results and provides all the BBC programmes at the turn of a switch. A very effective automatic frequency control circuit ensures that no drift occurs. The front-end unit which includes RF Stage, Mixer-oscillator and the reactance valve is supplied already built and aligned. We supply complete kits or any of the components separately as required. Fully detailed list sent upon request. **NOTE**.—All resistors kits are supplied labelled with position and value.

COMPLETE KIT, £9.19.0, POST FREE

CREDIT TERMS. Deposit £1.10.6 and seven monthly payments of £1.7.0.

Separate items available as follows:

JASON.—Front end unit. Complete with valves and lined up. £6.5.0. Drilled chassis and panels, 9/6. Heater Chokes, 1/6 pr. IF Transformers, L4. Two required. 5/9 each, L12, 11.6.

VALVES.—EF80. Three required. Mullard, 19/-. Alternative, 10/- ea

CONDENSERS.—Kit of 14, 9/-. Any value separately, 9d.

RESISTORS.—Kit of 15. All labelled, 5/-. Any value separately, 4d.

CRYSTAL DIODES.—GEC GEN34. Two required. 4/- each.
See our list for other items.

MULLARD 510 AMPLIFIER

INSTRUCTION MANUAL.—Gives full details of the 510 and Pre-amplifiers. 3/6, plus 4d. postage.

RESISTORS.—LAB Kit for Main Amplifier. Includes all fixed resistors and three potentiometers. 39/-.

CONDENSERS.—TCC Kit for Main Amplifier, 45/-. Our Kit for Main Amplifier. Contains all brand new condensers of good manufacture. 29/6.

MAINS TRANSFORMERS.—Elstone. MT510 for Main Amplifier only 42/-. MT MC for Main Amplifier with Pre-amplifier or FM Tuner, 45/-.

CHASSIS.—Denco. Fully drilled. Complete with base and screen. 19/6

OUTPUT TRANSFORMERS.—Partridge. P367. For 6,000 and 8,000 ohms. 52/6. Gilson W086A for 8,000 ohms. 47/6. Gilson W069B for 6,000 ohms. 47/6.

OUTPUT TRANSFORMERS.—ULTRA LINEAR.—Gilson W0710: 8K, 32/6. W0692. 62/6. Partridge P4014. 98/6. P5302. 95/-. Elstone OT ML, 45/-.

PLUGS AND SOCKETS.—Elcom. 6-pin Chassis Socket S06, 4/3. 6-pin Flex Plug S061, 5/6. 4-pin Chassis Socket S04, 3/3. 4-pin Flex Plus S041, 5/-. Bulgin P310, 4/6. P390, 4/3.

VALVES.—EF89 Mullard, 24/4. Our alternative, 15/-. ECC83 Mullard, 19/-. Our alternative, 10/-. EL84 Mullard 16/-. Our alternative 12/-. EZ80 Mullard, 11/10. Our alternative 8/6. EZ81 Mullard 11/10.

OTHER COMPONENTS.—Full details of the other components required are given in our four page list available free upon request.

COMPLETE KITS.

KIT A. Complete kit of components with alternative valves and condensers with Elstone MT510 Mains Transformer and Gilson Output Transformer, £14.0.0.

Other kits available. See list for full details.

PRE-AMPLIFIERS.—We have all items for both Pre-amplifiers. Full details in list.

MULLARD TAPE AMPLIFIERS

All components for these Amplifiers as described in the Mullard Publications are always carried in stock.
AMPLIFIERS TYPES A & B.—See our Advert. in P.W. October issue for detailed prices or send for free price list.
AMPLIFIER TYPE C.—This is a new version of the Type B Amplifier. Send for free price list and details.

GRAMOPHONE EQUIPMENT

BSR MONARCH RECORD CHANGERS.—The latest four-speed model with turn-over crystal pick-up. £3.2.6. Credit Terms, Deposit £1.5.0 and seven monthly payments of £1.2.6.
RECORD CHANGERS AND PLAYERS.—We have a selection of these by various makers with some at special prices. Write for our latest list of offers.

TEST INSTRUMENTS

AVO METER MODEL 8.—This finest of all Test Meters is always in stock. Cash Price, £23.10.0. Credit Terms, Deposit £3.9.0 and seven monthly payments of £3.3.0.

NEW AVO MULTIMINOR

A Brand New Meter at a very attractive price. A.C. & D.C. volt, D.C. current, 2 ohms ranges. Movement is 100 μ A (10,000 ohms per volt). Illustrated leaflet available. Cash Price £9.10.0, credit terms. Deposit £1.8.0 & 7 monthly payments of £1.6.0.

RECORDING TAPE

All sizes of tape and empty spools by the following makes are stocked. BASF, Emitape, Ferrograph, MSS and Scotch Boy. We have a list of these available which includes details of many Tape Accessories which we also carry.

TRANSISTORS

SURPLUS TYPES
Special offer of the famous Red Spot, 7/6 each. Four for 27.6. RP Junction Type. Red Yellow Spot, 21/-. AP Junction Type. Yellow Green Spot. Pair in push-pull give 250 mW. 10/- each.

MULLARD TYPES

OC70, 21/-. OC71, 24/-. OC72 Matched Pairs, 60/-.
All transistors post free.

TRANSISTOR COMPONENTS

We have many types of miniature and sub-miniature condensers and other components. Fully detailed list available free.

CREDIT TERMS

Any of the above items can be supplied on Credit Terms. Details are as follows:—

SEVEN MONTHLY PAYMENTS. Deposit 3/- in the £ and balance plus a small service charge (10% of balance, but minimum charge £1) payable in seven monthly payments.

THREE MONTHLY PAYMENTS. Deposit 6/- in the £ and balance plus a small service charge (5% of balance, but minimum charge 10/-) payable in three monthly payments.

TERMS OF BUSINESS.—Cash with order or C.O.D. Postage extra under £3. We charge C.O.D. orders as follows. Up to £3, postage and C.O.D. fee, minimum 2/5. Over £3 and under £5, C.O.D. fee only 1/6. Over £5 no charge.

WATTS RADIO (MAIL ORDER) LTD.

54 CHURCH STREET, WEYBRIDGE, SURREY

Telephone: Weybridge 4556

PLEASE NOTE. POSTAL BUSINESS ONLY FROM THIS ADDRESS.

THE LINEAR 'DIATONIC'

A 10-WATT HIGH FIDELITY ULTRA LINEAR AMPLIFIER WITH INTEGRAL PRE-AMP

A special feature is the compactness of the unit. Full advantage has been taken of latest component miniaturisation developments to produce a 10-watt Hi-Fi push-pull amplifier incorporating tone control pre-amplifier stages within the measurements of 9 x 7 x 6½ ins.

In addition two high impedance input sockets are provided for microphone and gram, etc. Each input has its associated vol. control, five B.V.A. (Mullard) valves are employed ECC83, ECC83, EL84, EL84, EZ81, H.T. and L.T. power supply point is included for a radio tuner.

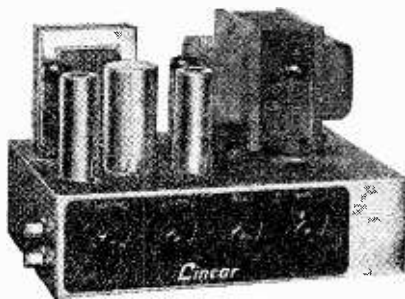

FREQUENCY RESPONSE
± 2 d.b., 30-20,000 c.p.s.

MAXIMUM POWER OUTPUT

In excess of 14 watts.
RATED OUTPUT 10 WATTS.

SENSITIVITY

Volume (1) 22 millivolts for rated output.

Volume (2) 220 millivolts for rated output.

TREBLE LIFT CONTROL
Continuously variable ± 6 d.b. to -13 d.b. at 12,000 c.p.s.

BASS CONTROL

Continuously variable ± 13 d.b. to -18 d.b. at 15 c.p.s.

HUM LEVEL

Referred to maximum output and including integral pre-amp -60 d.b.

HARMONIC DISTORTION

0.19%, measured at 6 watts.

NEGATIVE FEEDBACK

Total 32 d.b. including 24 d.b. in main loop.

Weight 12½ lbs. Power consumption 90 watts. For 200-230-250v. 50 c.p.s. A.C. mains.

Outputs for 3- and 15-ohm speakers.

Chassis finish stoved Blue-Grey hammer.

HIGHEST QUALITY!

Retail price

MAXIMUM RELIABILITY!

AT A PRICE YOU CAN

AFFORD. Available through

your local dealer, leading mail order firms, or direct from us. Send S.A.F. for descriptive literature.

12 GNS.

TRADE ENQUIRIES to

L45 MINIATURE 4/5-WATT QUALITY AMPLIFIER

Size only 6 x 5 x 5½ in. high. 12 d.b. Negative Feedback, Sensitivity 30 m.v. for full output. 3 Mullard valves, ECC83 Twin Triode, EL84 Power Output, EZ90 Rectifier. Separate Bass and Treble Controls. Mains switch incorporated in control. For 200-250 v. 50 c.p.s. A.C. Mains. An ideal unit for use with Gram. or 'Mike.' Output matching for 2-3 ohm speakers.

Retail Price **£5-19-6**

Also available: LG3 3-watt Gram Amplifier. 49.9. LT.45 Complete Tape Amplifier. 12 gns.

LINEAR PRODUCTS LTD. 5-9 MAUDE STREET, LEEDS, 2.

Tel. 23116

FIRST-CLASS RADIO COURSES...

GET A CERTIFICATE!

QUALIFY AT HOME—IN SPARE TIME

After brief, intensely interesting study—undertaken at home in your spare time—YOU can secure your professional qualification. Prepare for YOUR share in the post-war boom in Radio. Let us show you how!

FREE GUIDE

The New Free Guide contains 132 pages of information of the greatest importance to those seeking such success-compelling qualifications as A.M.Brit.I.R.E., City and Guilds Final Radio, P.M.G. Radio Amateurs, Exams, Gen. Cert. of Educ., London B.Sc. (Eng.), A.M.I.P.E., A.M.I. Mech.E., Draughtsmanship (all branches), etc., together with particulars of our remarkable Guarantee of

SUCCESS OR NO FEE

Write now for your copy of this invaluable publication. It may well prove to be the turning point in your career.

FOUNDED 1885—OVER

150,000 SUCCESSSES

NATIONAL INSTITUTE OF ENGINEERING

(Dept. 461), 148, HOLBORN, LONDON, E.C.1.

TELETRON TYPE FX.25



Self-tuned, Dual-wave Ferrite Rod Aerial, 15/- each.

Designed for use in pocket Transistor receivers. Descriptive folder with circuit-component layout, and wiring instructions for a three-Transistor regenerative receiver. Price 6d. NO aerial, earth or tuning condenser required. Operates speaker from 3 Penlight cells. All parts, including cabinet and chassis, available from component stockists.

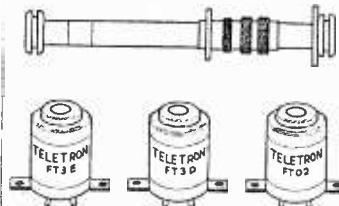

Miniature Transistor IFTs & Osc coil for 315 kc/s, 6/6 ea. FRM.2 Transistor Ferrite Rod Aerial. 10/-. Available from component stockists. Stamp for complete lists and circuits.

THE TELETRON Co. Ltd.
266 Nightingale Rd., London N.9

HOW 2527

ALFRED PADGETT

40, MEADOW LANE, LEEDS, 11

Tel. : CLECKHEATON 99

VALVE TESTERS.—Ex R.A.F. Type 4A, complete with case and meter. Not tested. £3 17/6, carriage 7/6.

BRAND NEW TX TYPE 440B.—Freq. 86.3 mc., complete with 3 Det. 19, 2 6N7 and 1 6G6 valves, 17/6, carr. 7/6.

Make a set of Fairy Lights. Bulbs 24 volt miniature, 4/6 per doz. Post 1/-.

BRAND NEW EF50 VALVES.—Four on a strip with valveholders and locking rings, 10/-, post 2/-.

CIROKE.—3 hy., 150 mill, 1/6, post 1/6.

8-WAY JONES PLUG AND SOCKET, 1/-, post 1/3.

MIXED B.A. NUTS AND BOLTS.—Half a pound for 1/6, post 1/6.

PAPER BLOCK CONDENSERS.—3 mf., 500 v. working, 3/-, post 1/6.

NEW RED SPOT TRANSISTORS, 7/6. Diodes 10d. each. Not rejects. Post 3d.

OCTAL VALVEHOLDERS.—Removed from new sets. Amphiphal Type, 2/6 per doz., post 9d. Int. or Mazda.

NEW T.C.B. PARTS.—Mike Drives, Vernier Drives, 2/6. Switch and knob 1/-, Handles, 9d. each. Coil former Pot., 6d. Post 1/- each extra.

VALVES, GUARANTEED GOOD.—5U4, 6/6; 5Z4, 6/6; 6V6, 6/-; 6SN7, 5/-; EF50, 2/6; 6J5, 2/6; 6J6, 3/6; 6C4, 2/6; 6D6, 3/-; 6C3, 3/-; 6B8, 2/-; 6H6, 6d.; 6K7, 2/-; 6G6, 3/-; VR65, 1/6; VR66, 1/-; VR137, 1/-; 954, 1/3; Pen 46, 2/6; VR150 30, 4/-; ARP12, 3/6; QP220, 1/6; VS110, 1/-; AC6 Pen, 2/6; VR32, 9d.; DL-S10, 2/6; 2X2 1/6; VR54, 9d.; 12S7M, 4/-; 12SG7M, 4/-; 12SH7M, 3/-; 12HM, 1/3; 12CN, 4/-; 12ABM, 4/6. All valves 9d. post.

Inter-station Noise Suppression on F.M. Receivers

METHODS OF OVERCOMING A DIFFICULTY IN HIGH-QUALITY RECEIVERS

A FREQUENCY-MODULATED receiver, as long as it is tuned in accurately to a station, will have no background noise. Unfortunately, between stations the input voltage will consist of random noise which, if a limiter is used, will be too weak to operate the limiter enough to cut it out, but the noise will be sufficient to cause a certain amount of irritation. This is due to the fact that under these conditions, the limited functions as an amplifier, and

grid. Valves capable of high current flow should be used. Triodes are shown in diagram, but pentodes can be used.

Another Method

In a frequency modulated receiver there are several points where the required negative biasing voltage to control the squelch valve, may be obtained. One point is the grid circuit of the limiter stage. In Fig. 2 the grid of the squelch valve is directly connected to the grid circuit of the limiter. The negative voltage developed here is sufficient, with a signal, to keep the suppressing valve V2 at, or beyond, cut-off. During these periods the section of the audio amplifier operates normally. As soon as the negative voltage is removed from the grid of the suppressing valve, a large current flows through R1 and biases the audio amplifier to cut-off. This suppressing valve should have a high mutual conductance, in the range of 8 to 10,000 micro-ohms, so that it is capable of large currents with comparatively small negative volt changes on its grid. R2 and C1 form a filter to prevent I.F. currents from reaching the suppressing grid (V2).

An Alternative

As mentioned previously, there are other points from which this required negative biasing voltage can be obtained. In Fig. 3 it is the D.C. voltage available at the discriminator that is utilised for control. If we examine the individual polarity across the two discriminator resistors, we notice that point A will always be negative with respect to point B, as long as a signal is being received. It should be noted that we are only referring to the voltage appearing across the lower resistor and not across both resistors, as for the audio output. The voltage obtained from point A consists of an audio component due to the frequency

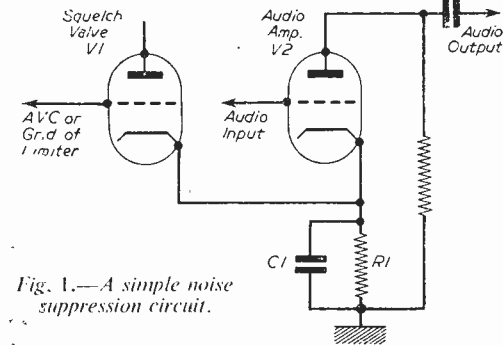

Fig. 1.—A simple noise suppression circuit.

these amplitude modulated voltages produce a loud hiss in the speaker. There are several methods of suppressing this inter-station noise. The basic idea behind these suppression systems, involves the use of a valve that is maintained at cut-off point as long as sufficient signal voltage is being received. When the input signal decreases, as one tunes off the station, the valve will conduct. The current through the valve is then made to flow through the audio amplifier cathode resistor and biases this valve to cut-off point. This condition is maintained until the signal strength of the receiver again increases (as when tuned to a station).

Fig. 1 gives a simple arrangement of this. In this circuit V1 is the suppressing or squelch valve and V2 the audio amplifier. Both valves have a common cathode with resistor R1 and condenser C1. As long as V1 is maintained at cut-off by a negative voltage on its grid, V2 functions as usual, but removal of the voltage on grid of V1, or a decrease of it, will bring V2 to cut-off point, because of the higher voltage across R1. This cut-off lasts until V1 again has a negative voltage applied to its

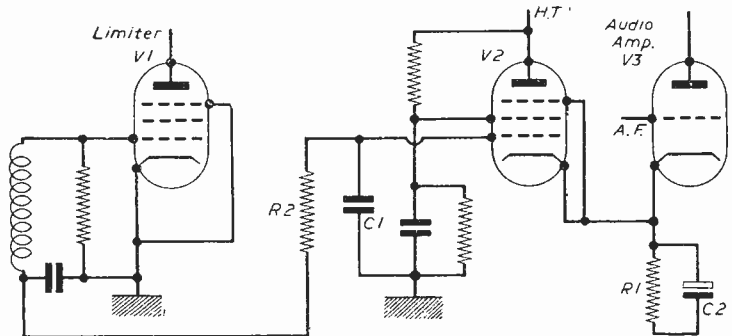

Fig. 2.—An alternative to the arrangement in Fig. 1.

shift of the signal and a D.C. component arising from the magnitude of the signal. Whilst the signal possesses sufficient amplitude to operate the limiter at saturation, the negative voltage present at point A will be strong enough to keep the suppressing valve V2. at cut-off. This will permit the audio amplifier V3 to function normally. When, however, the signal is tuned out, the voltage at point A drops, V2 begins to conduct and the audio amplifier V3 is stopped from functioning. R1 is a resistor common to both V2

and V3. A filter circuit is put in between point A and the grid of V2 to eliminate the audio component of the voltage at point A and thus present a D.C. voltage to V2.

It must be appreciated that these inter-station suppression circuits will not be needed in a receiver using a ratio detector, where the signal noise between stations is fairly low. These circuits are very useful in the type of frequency modulation receivers using limiters and discriminators.

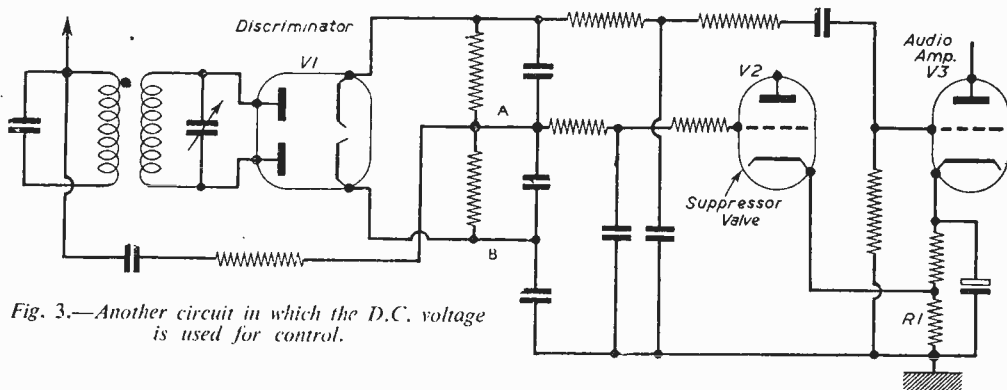

Fig. 3.—Another circuit in which the D.C. voltage is used for control.

Recent Solar Activity

CONSIDERABLE interest, largely aroused by the inauguration of the International Geophysical Year, has been shown by the public in the recent solar activity. In order to see this in its proper perspective it is necessary to obtain a general background picture of the Sun's behaviour.

It has been known for over a century that solar activity rises and falls in an approximately 11-year cycle. By 1850 it was also realised that the Sun strongly influenced the variations in the Earth's magnetic field, the activity of which closely follows the solar cycle.

The most obvious manifestation of the Sun's activity is the appearance of sunspots. These are small, disturbed areas on the Sun which, being cooler than the adjacent surface, show up by contrast as dark spots. The life of a sunspot may be anything between a few hours and several months.

The Sun rotates about its own axis in just over 27 days (as seen from the Earth) and so a spot lasting for a passage of the disc will be seen for about a fortnight.

Sunspots vary greatly in size and frequency during the solar cycle. At times of minimum activity the Sun may be spotless for as many as 200 days in a year, while at maximum there may be more than 20 groups visible at once, many consisting of several individual spots.

The larger groups are easily visible to the naked eye when the Sun's light is cut down by fog or when viewed through a dark glass.

Solar flares are shortlived, sudden increases in the intensity of the surface brightness in the neighbourhood of sunspots and can be normally

seen only in the light of particular wavelengths, for example, the hydrogen line in the red part of the Sun's spectrum.

Flares are very common at peak solar activity, the frequency even rising to an average of a flare every two hours for considerable periods.

Most flares are small and of short duration, having a life lasting a quarter of an hour or so. The individual influence of such a flare is negligible, but in the case of big flares (the longest-lived of which have lasted about 7 hours) their ultra-violet radiation affects the ionosphere, or electrically charged layers lying some 80 miles above the Earth's surface.

Communication Affected

As radio waves are reflected by the ionosphere, disturbances caused by solar radiation interfere seriously with radio communications. These sudden short-wave fadeouts are coincident with flares (this has been known for more than 20 years), but there is also a secondary effect which may occur a day or so after a large flare, due to a stream of corpuscles from the neighbourhood of the flare reaching the Earth.

If sufficiently intense, the effects give rise to world-wide magnetic and ionospheric storms which may last for a few days and cause serious and prolonged disruption of radio signals.

At any maximum of the solar cycle, therefore, continued periods of fairly frequent disturbances can be expected.

The International Geophysical Year has been timed to coincide with such a period of activity so that the effects on the Earth can be assessed. The disturbances at the beginning of July and September were caused by several medium-sized sunspot groups and associated large flares.

PREMIER RADIO COMPANY

B. H. MORRIS & CO. (RADIO) LTD.

OPEN TILL
6 P.M. SATURDAYS

(Dept. P.W.12) 207, EDGWARE ROAD, LONDON, W.2

Telephone:
AMBASSADOR 4033
PADDDINGTON 3271-2



The "Petite" PORTABLE

A completely new design with the all star feature from the firm with 45 years of experience in the supply of designs for the home constructor.

MAY BE BUILT FOR

£7.7.0

Plus p. & p. 3/-.

Batteries Extra. H.T. 10- (type B126) or equivalent. L.T. 1.6 (type AD35) or equivalent.

- ★ Size only 8 in. x 6 in. x 4 in.
- ★ Weight including batteries 5 lb.
- ★ 4 Valves of the economy type.
- ★ Medium and Long wave superhet circuit.
- ★ High Q frame aerials.
- ★ High sensitivity on both wavebands.
- ★ Preamplified I.F. transformers.
- ★ 5" Speaker of the latest type.
- ★ Automatic on/off switch operated by lid.
- ★ Simple to construct using normal soldering methods.
- ★ Mains Unit will be available later.
- ★ Instruct. Book 1/6.

MAINS UNIT NOW AVAILABLE for ONLY 37/6 plus 2/- D.P.

The NEW De - Luxe TAPE RECORDER TR3

for

£5.18.0

Deposit and 2 monthly payments of £5.16.3.

or Cash 45 sus. Plus 2/- post and packing.

Case finished in Red and Cream with gilt styling and fittings. Size 18 in. x 15 in. x 9 in. for A.C. Mains 200 250 v. 50 cycles.



TRADE ENQUIRIES WELCOME

BUILD THE PREMIER 1-VALVE BATTERY RECEIVER

As shown on B.B.C. T.V. This receiver contains a DAF 96 valve and a pair of 4,000 ohm headphones, and is powered by a combined 67 and 1 1/2 volt battery. Price complete with headphones but less battery 45/-. Battery 8/3 extra. Send for free diagram.

STIRLING V.H.F./F.M. TUNER UNIT

A cleverly designed unit suitable for installation either in existing equipment or as an external Unit. Completely self-contained with its own power supply. The latest type permeability tuned circuit is used, tuning drift being negligible. Size 7 1/2 x 7 1/2 x 2 1/2 in. Cash Price £13.13.0. Postage & packing 2/6 extra. Cr. Terms £1.15.0 deposit and 8 monthly payments of £1.13.6. Plus postage & packing of 2/6.

THE TELETRON "COMPANION" 3 TRANSISTOR POCKET RECEIVER

This receiver may be built for **89/6** complete. Postage and packing 1/6.

New F.M. TUNER for the Home Constructor

A new design using the latest circuit techniques. Includes 4 valves plus magic eye tuning indicator, permeability tuning and an integral power supply. Two controls only, a gear driven slow motion tuning control and an output volume control with on/off switch. Suitable for fringe area reception. All components may be purchased for **£8.15.0** plus packing & postage 3/6. OR Less Mains Transformer & Rectifier **£7.12.6** plus packing & postage 3/-. Power requirements HT 230 v. 50 mA. LT 6.3 v. 1.5 A. Dial size 3 1/2" x 1 1/2". Overall size 11 1/2" long, 5 1/2" deep, 4 1/2" high. Send 1/6 for Booklet.

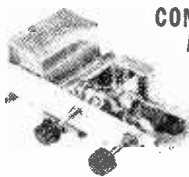

COMPACT GRAM AMPLIFIER

Complete ready to connect to any type of Pick-up and Speaker (3 ohms) A.C. Mains 200 250 v. Volume and tone control fitted with knobs. Overall size 7 1/2 in. long x 3 1/2 in. wide x 2 1/2 in. high.

Suitable speaker 7 x 4 in. elliptical 21/0. Plus packing and postage 2/6.

£2.19.6

4-WATT AMPLIFIER

MAY BE BUILT FOR **£4.10.0** Plus 2/6 Pk. & Carr. Instruction Book 1/- post free.

A steel case is now available, complete with enameled panel, for 15/6 extra. The amplifier may be supplied complete for **£5.5.0** plus pkg. and post 3/6, or fitted in case at **£6** plus pkg. and post 3/6.

2-BAND T.R.F. RECEIVER

MAY BE BUILT FOR **£5.15.0** Plus 3/- Pk. & Post.

3-Band Superhet Receiver may be built for **£7.19.6** plus pk. & carr. 1/- These two receivers use the latest type circuitry and are fitted into attractive cabinets 12 in. x 6 in. x 3 in. in either walnut or ivory bakelite or wood. Individual instruction books 1/- each, post free.

WRITE FOR DETAILS OF PREMIER TAPE RECORDER KIT FOR ONLY **£38.15.0**.

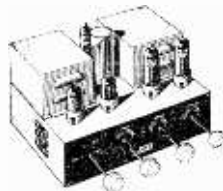

8 WATT AMPLIFIER

This design includes 5 miniature valves of the latest types, an ultralinear output transformer suitable for Speakers of 3 and 15 ohms and a very attractive perspex front panel with gold lettering, complete set of parts

Postage & packing **£8.8.0** 5 - extra. or **£10.19.6** built and tested. Send 1/6 for Booklet.

B.S.R. T.U.8 3-speed Record Player **£4.12.6** plus 2/6 post and packing. P.C. complete with arm. 36/-

THE LATEST COLLARO 4-SPEED SINGLE PLAYER UNIT COMPLETE WITH PICK-UP AND TURNOVER CARTRIDGE. **£4.12.6**. PLUS 2/6 P.K. & CARR.

Why not make the best! MULLARD AMPLIFIER KIT

Now supplied with ultralinear output transformer.

All the components for Model 510, plus pre-amplifier, on one chassis (total six valves), chassis gold hammer finished. May be purchased for **£12.12.0** plus pkg. and post 7/6. This version complete and tested. **£15.15.0**. Or pre-amplifier and tone control in a separate unit **£14.12.0**, plus pkg. and post 7/6.

FM at its best — with HOMELAB

The **NEW** frequency modulation tuner

● The new **HOMELAB** Frequency Modulation Tuner conforms exactly to the famous Mullard design.

● A **volume control** is incorporated and also switching for gramophone, AM tuner and tape deck in addition to FM.

● The **tuner** is fitted with a pleasing bronze-finished escutcheon and a lead fly-wheel is coupled to the tuning knob to ensure smooth and accurate tuning in conjunction with a magic-eye tuning indicator.

● The **unit** can be supplied with or without power supply.

PRICE **£12-10-0** PLUS 5/-
POSTAGE & PACKING

(INCLUSIVE OF POWER SUPPLY)

Please send stamped addressed envelope for full details.

Homelab Instruments Ltd

615-617, High Road, Leyton, E.10.

Telephone: LEYtonstone 6851

MANUFACTURERS OF INSTRUMENTS FOR THE RADIO AND ALLIED INDUSTRIES

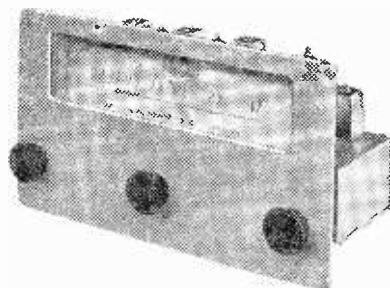

REPANCO HIGH GAIN COILS

Dual Range Crystal Set Coil, Type DRX1	...	2/6
Dual Range Coil with Reaction, Type DRR2	...	4/-
Matched Pair Dual Range T.R.F. Coils, Type DRM3	... pair	8/-
Pair Dual Range Superhet Coils, Type SH4	... pair	8/-
Miniature Iron Dust Cored Coils, Type "R":—		
Range	Aerial	H.F.
800-2,000m.	RA1	RHF1
190-550m.	RA2	RHF2
70-230m.	RA3	RHF3
15-50m.	RA4	RHF4
		Osc.
		RO1
		RO2
		RO3
		RO4
Ferrite Rod Aerial, Dual Range Type FR1	...	12/6
Miniature I.F. Transformers, Type MSE (465 Kc/s)	... pair	12/6
Standard I.F. Transformers, Type TCG (465 Kc/s)	... pair	13/6
Three Waveband Superhet Coil Pack, Type LMS	...	36/-
E.M. Coil Set	...	25/6
(All components boxed complete with circuits.)		
Send S.A.E. for complete list of Repanco components.		

Making your own radio set as featured on B.B.C. Children's Television. All components for this receiver in Stock. Send S.A.E. for complete price list.

RADIO EXPERIMENTAL PRODUCTS LTD.
33 MUCH PARK ST., COVENTRY.
Tel. 62572.

Train for a Wonderful future
in **RADIO & TELEVISION...**

...with **E.M.I.**

Radio and Television techniques are continually advancing and their applications ever increasing. These fields offer to the trained technician a career with an assured and remunerative future. Here is your opportunity to enter for:—

1 YEAR COURSE Full-time day course in the Principles and Practice of Radio and Television. Mainly designed for the training of Radio and Television Servicing Engineers. Next courses commence on 7th January, 1958.

THE E.M.I. COLLEGE OF ELECTRONICS

Dept. 32, 10 Pembroke Square, London, W.2
Telephone: BAYswater 5131/2

The College is part of the E.M.I. Group... Britain's foremost electronic engineers... Pioneers of the world's first public television service



TRANSMITTING TOPICS

MORE ABOUT AERIALS

By O. J. Russell, B.Sc., A.Inst.P. (G3BHJ)



THE keen beginner is likely to retreat into the line of least resistance and erect dipoles for each band he desires to cover. There is a limit to this, of course, as a dipole for topband requires some 265ft. of wire. Moreover, an array of dipoles for each band is liable to occupy space on a grand scale, and to cost a tidy sum for the feeders for each dipole as well. Further, there is no special merit in a dipole aerial, and it does not guarantee good results on the band for which it is cut. In fact no aerial will guarantee good results, and unless "other factors" are carefully considered no aerial is likely to give good results.

It is as well to examine some beliefs and superstitions concerning aerial systems, in order to establish some firm facts about them. First the question of radiation efficiency. Let it be firmly established that any aerial whatsoever, if efficiently fed, will radiate all the energy, with the exception of that energy consumed in losses in the resistance of the aerial and the coupling system. To reduce this to absurdity, if the energy is not radiated or lost in R.F. losses it can only be returned to the transmitter, and therefore has not been fed to the aerial! Thus an efficiently fed aerial—apart from R.F. losses in insulation and resistance—radiates the R.F. energy, and it does not matter if the aerial is an inch long or a mile long—the available energy is radiated. However, before a topband aerial an inch long is pressed into service, it is well to point out that inevitable resistive losses in the coupling system would absorb 99.999 per cent., or thereabouts, of the available R.F. energy. The tiny difference would be radiated. In fact a

superconductive aerial coupling system might enable even a very short aerial to radiate a good proportion of R.F., so that an efficient topband aerial might only be a foot or so long. What is not realised is that this also applies to reception, and but for circuit losses, a very short aerial is about as good for reception as a halfwave dipole. However, here again the circuit losses become so huge if impossibly short aerials are used, that a practical aerial has to be of a "reasonable" length. In fact an aerial must be a "reasonable" fraction of a halfwave dipole, and by the time an aerial is only a tenth of a wavelength long, it is already rather "short!"

In many millions of homes an outside aerial of, say, 30ft. is a rarity, and indeed many broadcast sets operate with only a few odd feet of wire as aerial. Nobody stops to consider that when receiving on the long waves an aerial of around some 2,500ft. represents a half-wave dipole, and that even a "better than average" domestic aerial represents something like one hundredth of a wavelength. By comparison this is using a foot of wire or so for topband reception, or equivalent to a few inches of wire on 10 metres! Clearly there is some sizeable fly in the ointment, for even under ideal conditions a few inches of wire is virtually useless on 10 metres, while the "proportionally equivalent" long wave aerial serves quite satisfactorily. The idea that a large aerial gets a "better grip" on the ether seems to have some substance. Or

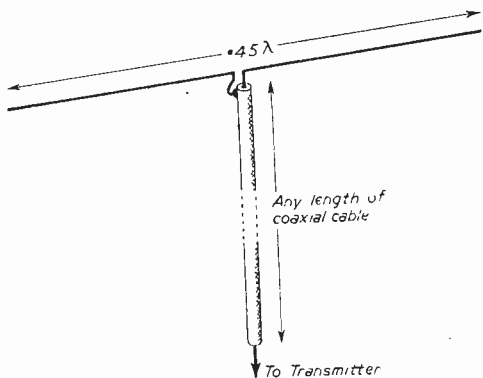

Fig. 1.—The simple coax-fed dipole. The unbalanced feed is not altogether satisfactory.

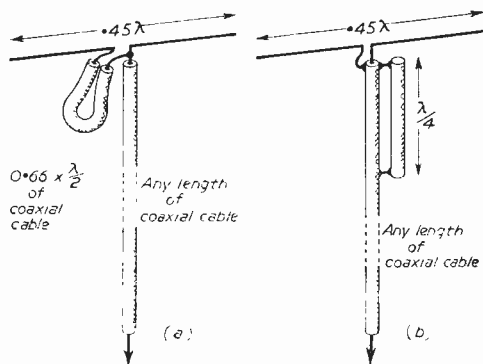

Fig. 2(a).—One method of balancing the feed to a coax-fed dipole. The length assumes that solid insulation coax is used.

Fig. 2(b).—The "bazooka" method of ensuring balanced feed. The quarter wave section may be the outer sheath of a piece of coaxial cable.

rather than a "reasonable" length of wire is a useful aerial on almost any wavelength, regardless of whether it is a microscopic fraction of a half wavelength or not.

An Explanation

The facts behind the above reasoning or intuitions are as follows. Consider aerials in free space, to avoid any nonsense about ground reflections. Now if we take halfwave dipoles and feed them with the same amount of R.F. power, then the field strength at a given point at the same distance from the dipoles will be the same. That is to say, whatever the wavelength (within reason) the same amount of R.F. power is equally well radiated by a halfwave dipole. Thus if we were in free space, 10 watts to a 160-metre half-wave dipole would produce at, say, 100 miles a given field strength. Similarly a 10-metre dipole fed with 10 watts of 10-metre R.F. will produce exactly the same field strength at 100 miles as we have from the 160-metre transmission. It should be noted also, that at 100 miles the 10-watt signals will be good signals, with a solid field strength of over 100 microvolts per metre. The essential point is that halfwave dipoles fed with the same amount of R.F. radiate in precisely the same way, and if fed with R.F.

receiver using a 10-metre dipole, despite the fact that the R.F. field strengths are the same. That is, our signal intercepted on 10 metres is 24 db or 4 S points down on the signal intercepted by our 160-metre dipole on the 160-metre transmission, despite the fact that the field strength of the two signals is the same.

Clearly our large 160-metre dipole has a "better grip" on the ether for 160-metre transmissions than a 10-metre dipole has for 10-metre transmissions! Also this is no small difference, but the actual voltage to operate our receiver has fallen off to one sixteenth, exactly the ratio of the lengths of the aeriols concerned! Moreover, the power ratio is, of course 16, or 256 times, so on 10 metres we have intercepted just 1/256th of the energy intercepted on 160 metres. Of course, the textbooks go into this in a little more highbrow fashion and substitute "effective capture area" for "getting a grip on the ether." But the net result is the same, we need a modest 2,560 watts, say 2½ kilowatts radiated on 10 metres, to give the same effect on our receiver as a 10-metre dipole, as a modest 10 watts radiated to a 160-metre dipole and receiver on the 160-metre wavelength! Somebody should surely be complaining that in view of all this it should be difficult not to work fabulous DX on topband, and impossible on 10 metres! However, this is not so, as ionospheric and other matters interfere to confuse the issue which, in free space, is crystal clear.

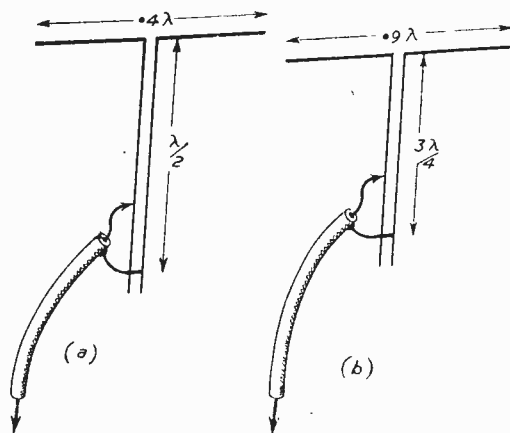

Fig. 3a.—A tunable stub enables a balanced feed to be assured, and also permits adjustment for multi-band operation.

Fig. 3b.—The tuning stub set for operation on the second harmonic.

at the frequency for which they are cut, will produce the same field strengths at the same distances. Thus, if "economy of wire" is a point, it would seem that a VHF transmission only needs a small aerial to produce the required field strength, and that VHF is ideal for communication . . . at any rate in free space!

However, a shock is in store for us when under the above conditions we use a halfwave dipole for reception. Thus with a 160-metre dipole on the 160-metre transmission we find the signal voltage developed across the grid of our receiver is 16 times that of the 10-metre

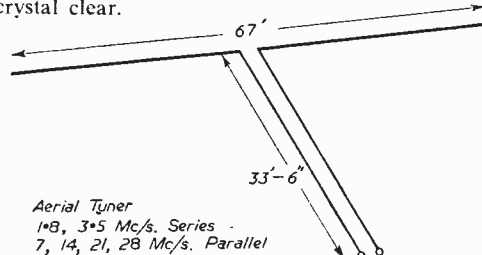

Fig. 4.—The 40-metre dipole, which is usable not only on harmonics of 7 Mc/s., but on the lower frequency bands as well.

No present-day amateur guide bothers to explain the actual vast "fall off" in capture area or "ether gripping" properties of a dipole with frequency. It is perfectly true that the signal voltage developed by a half-wave dipole falls off directly with the wavelength of operation, and that the power intercepted falls off as the square of the length of a halfwave dipole! A little quick thinking will reveal that a halfwave dipole on the long waveband is collecting something like ten times as much signal voltage, and hence 100 times as much signal power as an amateur using a halfwave dipole on top band. It is now clear why even a very "short"—electrically speaking—aerial on the long-waves gives quite a respectable signal. Even at 1 per cent. efficiency it would deliver as much power to a receiver as a full halfwave dipole would on 160 metres. Moreover, the long wave stations on the broadcast band operate with hundreds of kilowatts rather than

(Continued on page 729)

SKILLED MEN!

HERE'S A NEW WAY
TO BETTER YOUR INCOME!

Up to £25 tax-free bonus plus first rate wages for two weeks of your time

Are you in a skilled trade? Then you can probably add a tidy sum to your income by joining the Army Emergency Reserve. For one thing, you get pay and allowances at full Regular Army rates whilst in camp. And the more your skill's worth in civilian work, the higher your Army rank and pay. Better still, you also get £9-£25 bonus tax-free (£50 if you are an electronic specialist). For this you just spend 15 days a year at

a camp, working on your own speciality. And money's not the only profit you get from that. You get a grand refresher course, giving you a lot of new ideas, and putting you right in touch with the latest Army developments. And you get a welcome break from the usual routine, with sports, games and a great social life. For the place is full of people with the same interests as yourself. Don't miss this chance! Send off the coupon now to: H.Q., A.E.R., R.E.M.E., Broxhead House, Bordon, Hants.

VACANCIES
FOR
ARMAMENT ARTIFICERS
RADIO · RADAR
AND
ELECTRICAL CONTROL

POST THIS OFF RIGHT AWAY

Please send me—without obligation—the illustrated booklet telling all about the Army Emergency Reserve.

NAME

ADDRESS

TRADE

PW/AER

Perth SETS THE HIGHEST STANDARD

... for enthusiasts and those who appreciate the finer qualities of perfect sound reproduction, Perth Radios, manufacturers of electronic equipment, provide the complete answer with their fully guaranteed components at the keenest prices.



Perth
RADIOS LTD
COMPONENTS DIVISION



SEND FOR ILLUSTRATED CATALOGUE AND PRICE LIST

- COMPLETE RADIOGRAMS and RECORD PLAYERS
- ★ FREQUENCY MODULATED VHF and STANDARD AM RADIO RECEIVER and TUNER CHASSIS
- ★ CABINETS IN THE LATEST CONTINENTAL and BUREAU TYPE STYLING
- ★ HIGH FIDELITY and STANDARD SPEAKER UNITS
- ★ AUTOMATIC RECORD CHANGERS
- ★ DISC PLAYERS
- ★ AMPLIFIERS
- ★ LOUDSPEAKERS

MARTEN HOUSE
39-47 EAST ROAD, LONDON, N.1
Telephone : CLERKENWELL 2413/4



G2AK This Month's Bargains

D104 CRYSTAL HAND MIKES List £6

Complete with 6 ft. cord and plug. Very limited quantity. **ONLY £3.10.0** each.

CRYSTAL HAND MIKES in silver hammer case with polished grille and handle, complete with 4ft. screened lead, 22/6 post free.

HI-FI EQUIPMENT. Amplifiers, speakers, pick-ups by Grampian, Leak, Quad, Rogers, R.C.A., Spectone, W.B., Wharfedale, etc., available for immediate delivery.

HEADPHONES. H.R. Type 4,000 ohms, very sensitive. Only 12/6 pr. Post 1/6. C.L.R. type (low res.) 8/6. Post 1/6.

100 kc/s CRYSTALS, by famous American makers in 3-pin based holder. New condition. Worth £3/10/0. **ONLY 25/-** post free.

SEMI-MIDGET COMBINED I.F. TRANSFORMERS, 10.7 Mc/s and 465 kc/s (can be used on 10.7 Mc/s or 465 kc/s only). 9/11 per pair, postage 9d.

AERIAL WIRE. Copper, 7-25 stranded : 140ft., 10/-, 70ft., 5/-, Hard Drawn 14g. : 140ft., 17/-; 70ft., 8/6. P. & P. 2/-.

RIBBED GLASS 3in. AERIAL INSULATORS, 1/6 ea., or 6 for 7/6, 12 or more post free. Small shell porcelain, 4 1/2d. each or 4/- doz.

CONDENSERS. 8 µF 600 v. Trop. 750 v. normal condensers. NEW, ex W.D. stocks, 5/6. P. & P. 1/6.

ABSORPTION WAVEMETERS, 3 to 35 Mc/s in 3 switched bands. Complete with indicator bulb. 17/6 post free.

No C.O.D. on orders under £1.

Please Print Your Name and Address.

CHAS. H. YOUNG LTD.

Dept. 'P' 110, Dale End, Birmingham, 4. (CEN. 1635)

Taylor

JUNIOR UNIVERSAL METER



Model 120A

A small 21-range instrument ideal for the enthusiastic amateur. Sensitivity is 1,000 o.p.v. A.C. and D.C. Accuracy: 2% D.C.; 3% A.C.

Size: 4 1/2" x 3 1/2" x 1 15/16"
Weight: 14 ozs.

RANGES

Volts D.C. : 0-25-50-100-250-500-1,000-2,500.

Volts A.C. : 0-10-50-250-500-1,000-2,500.

Milliamps D.C. : 0-1-10-50-500-5,000.

Resistance : 0-2,000 ohms, 0-200,000 ohms. Can be extended to 20 megohms. Automatic overload protection fitted to meter movement.

PRICE £9.15.0. PROMPT DELIVERY

CREDIT TERMS: Nine monthly payments of £1.4.4.

ALL TAYLOR instruments available on HIRE PURCHASE and 7 DAYS' APPROVAL.

UNIQUE OFFER: You can part-exchange an old Taylor Instrument for a new one—write for details and catalogue.

TAYLOR ELECTRICAL INSTRUMENTS LTD.

Montrose Avenue, Slough, Bucks.
Telephone: Slough 21381. Cables: Taylins, Slough

the 10 watts of the amateur upon 160 metres, so that even with aerial efficiencies that actually are minute fractions of 1 per cent., the receiver still has a large actual R.F. input applied to it. It also becomes clear why in the early days of radio there was a mad rush to the longer and longer waves, and the amateurs were relegated to the "useless" wavelengths below 200 metres. Fortunately for the amateurs, "other considerations" intruded, and the shorter wavelengths proved to be useful for very long distance communication through the agency of ionised layers.

Influence of Frequency

It is salutary to remember that in fact a receiving dipole intercepts less energy as the frequency increases. Thus on the VHF's, where the radiation from a dipole is precisely the same in free space

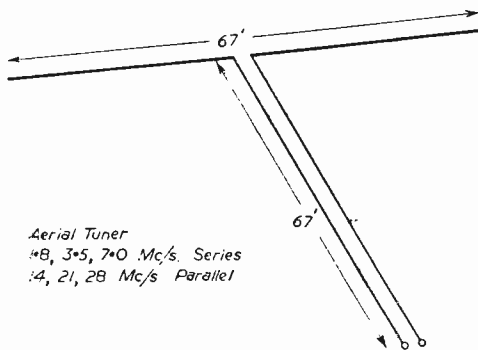

Fig. 5.—This alternative version of a centre-fed 40-metre dipole is also usable on all the usual communications frequencies.

as for any other dipole at any other frequency, the energy intercepted by a receiving dipole is minute. Thus at 1 metre it intercepts one hundredth of the energy, and one tenth of the voltage is generated for the receiver that would be intercepted on 10 metres. Thus a large receiving aerial array is needed in order to make up the 20 db difference from the dipole to dipole case on 10 metres. This is why beginners on the VHF bands may radiate a readable signal easily enough, but run into difficulties on reception. A dipole or simple Yagi is scarcely good enough. This difference in behaviour of aerial arrays on reception and transmission may account for the "one way" effects noted where a signal is transmitted and read at a distant station, but the other station is not heard, and transmission is called "one way." Obviously even a simple dipole will radiate effectively on the VHF's, but intercepts such a tiny amount of energy from incoming signals, that reception is just not possible. Moreover, the well-known difficulties with building sensitive low-noise VHF receivers and the rapid attenuation with distance complicate the VHF picture. Thus the "advantage" of the VHF's in that multiple element high-gain aerial systems may be built compactly is unfortunately offset by the fact that it is upon such frequencies that large high-gain aerial systems are essential. In order that the receiving end can intercept a useful fraction of the

incoming signal. In fact, for "average" results on almost any band it is necessary to occupy a fair space with the aerial system, in order to intercept a reasonable amount of energy at the receiver! As we have seen for transmission, a halfwave dipole radiates effectively whatever the frequency, so that even on VHF's the tiny dipole is an effective radiator.

While the above facts may be somewhat new to many, they do at least accord with the "intuitive" view that a large aerial "gets a better grip" on the ether. While this intuition is largely borne out in practice, it is actually not fundamentally true. Thus the real crux of the matter is the operating frequency, as even a tiny aerial is ideally just as effective a receiver or radiator as a half-wave dipole at the frequency of operation. This in practice is only an ideal conception, as with very short aerials the effect of tiny resistive losses becomes of astronomical importance. Thus, when to radiate effectively with only a few watts of R.F. power it is shown that this involves R.F. currents of thousands of amps in the wire, it is clear that even a fraction of an ohm will consume virtually all the power fed to the aerial, and, as is found in practice, virtually none is radiated. However, if the ideal "very short" aerial is fed by a circuit free from losses, it would radiate effectively and about as well as a full-sized halfwave dipole. However, practically one should not expect near miracles, even if these might be realised by superconducting components and ultra low loss dielectrics. An analysis of beam arrays shows that a "super-gain" compact beam array of high gain and very sharp directivity could be achieved if one is prepared to envisage currents of millions of amps circulating in the elements for modest input powers! Needless to say, "super-gain" arrays of this nature are unlikely to be realised. Similarly, when very short aerials are fed in an attempt to obtain radiation, the R.F. current in the aerial rises to very high values. When one is concerned with aerials that really are short, such as the whip aerials used for mobile topband use, then halving the length of the aerial just about quadruples the losses. Thus the tip for mobile operators is to use as tall a whip as possible, or to operate on as high a frequency band as possible, if effective radiation is desired. But for other reasons, 10 metres would be a very much preferable band to topband for RAEN mobile use, and topband "mobileers" could refer to back issues, where the importance of a little extra height in mobile whip aerials has been discussed. This shows conclusively that any striving for efficiency in the transmitter on topband operation is very secondary to increases in the height and radiation resistance of the whip radiator.

Some Examples

The newcomer may very truly object that he is not worried about mobile operation just now, but is interested in some form of aerial so that he can commence operations upon some band or other. The usual aerial suggested is a coaxial fed dipole (Fig. 1). This is not altogether as simple as it appears, as while a coax feed is regarded as the last word in efficiency, this is sometimes a delusion. Briefly, the trouble with

coax is that it is an unbalanced feeder, and the centre of a dipole needs a balanced feed. The coaxial "bazooka" is one means of providing a balanced feed (Fig. 2b). The halfwave length of coax provides a phase reversion section so that the two halves of the centre-fed dipole are fed correctly. Without some such device the unbalance of a simple coax feed may cause R.F. currents to travel on the outer sheath of the coax and thus cause a variety of troubles.

Correctly used, the coax feed is useful, in that even harmonics are not efficiently fed, so that combined with the screening provided by the

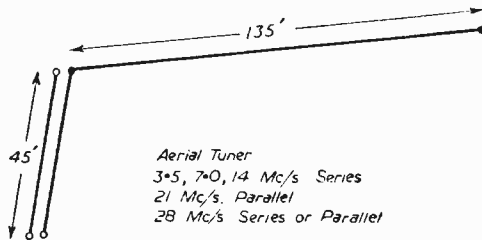

Fig. 6.—The Zepp fed aerial, which is a useful performer on all the usual DX communication bands.

cable, harmonic and TVI troubles are largely eliminated. For this reason a coaxially fed dipole is more or less a "one-band" device, although third or odd harmonic operation is possible. Thus a coax fed 40-metre dipole might also serve as a radiator for 21 Mc/s as well.

To avoid the uneconomic necessity of having separate aerials and feeders for each band is thus a problem with coaxially fed dipoles. One could have a plug and socket system to plug one main feeder into a number of dipoles, although this would still require "bazookas" to obtain symmetrical feeding of the dipoles. The stub of coax is unsightly and awkward, and is also quite an expensive item when several aerials are used. One can retain the convenience of coaxial feed, and get multiband operation by using a tunable matching stub Figs. 3 (a) and (b). The "tuning-up" of the stub on several bands and the transfer of the matching point may be effected in a few seconds, and enables a single aerial to operate with coaxial feed on several bands. Small clips or tapping points fixed at the experimentally determined positions enable the point of connection for each band to be accurately located. Moreover the tuning facility offered by adjustments of the shorting link in the stub enables the top to be resonated exactly on each band, so that good matching to the coax feed may be obtained. To indicate resonance on preliminary tuning-up tests, a low power bulb may be tapped across the shorting stub. Do not put the bulb in series with the stub, as it will absorb power excessively, and not necessarily give a good or accurate resonance indication. However, if the bulb is a low power flash-lamp type, good indication will be given if it is either shunted by a piece of wire, or—what is the same thing—clipped directly across the existing stub. This "loose coupling" of the bulb enables the stub to be tuned without disturbing the correct matching points, and the

bulb may even be left permanently in position. The stub, of course, may be made from bare wires with feeder spreaders at intervals, so that the tuning short may be moved up and down for adjustments.

For "multiband" operation, centre-fed dipoles are quite practical. As previously explained, a 40-metre dipole may be centre-fed and operated upon its harmonics, so that it may be used on 7, 14, 21 and 28 Mc/s. However, as has been previously explained also, such a centre-

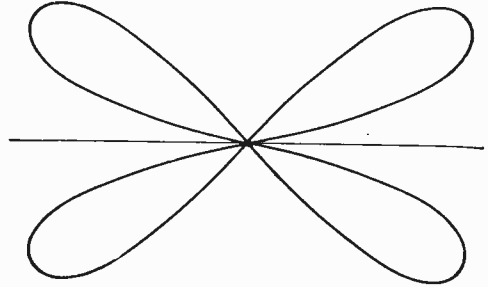

Fig. 7.—The approximate free space polar diagram of the Zepp aerial of Fig. 6, when operated on the higher frequency bands.

fed 40-metre dipole may be tuned up also on 80 metres and upon topband, and will radiate efficiently. Two popular versions are shown in Figs. 4 and 5. Despite the repeated "news" that a 40-metre aerial of this type will operate perfectly happily on 80 metres and topband, it still comes as a surprise to many. A little thought, of course, will show that the Fig. 4 aerial is actually a halfwave overall on 80 metres if we include the feeder length as well, so there should be no surprise that it tunes and loads up easily on 80 metres! Moreover, with recollections of our early discussions, these aerials are just as efficient radiators as full wave dipoles on 80 and 160 metres, and in fact have almost identical polar diagrams to the full length aerials!

The Zepp

One further old faithful standby aerial is the Zepp, and Fig. 6 shows the dimensions of one "sure fire" performer for all bands, 80 to 28. For topband use, the feeders may be tied together and the whole system tuned up Marconi fashion against ground or a counterpoise. Note that the system is a "long wire" on the H.F. bands, and will have a polar diagram roughly as shown in Fig. 7 on 21 and 28 Mc/s. A "long wire" is after all an aerial several half waves long . . . the antithesis of a "short" aerial. The long wire, in addition to the main lobes sketched roughly on the diagram, also has several minor lobes, depending upon length, and generally provides a fair coverage in many directions. Many leading DX workers use such aerials. However, one point to note is that the height of the aerial is quite important, both for the H.F. DX bands and the lower frequency bands. The effort to obtain, say, a 45ft. high aerial, over the customary 30ft. of many aerials, is well worth while.

There is a future
for YOU with the

LANCASHIRE DYNAMO GROUP

One of Britain's leading electrical manufacturing organisations

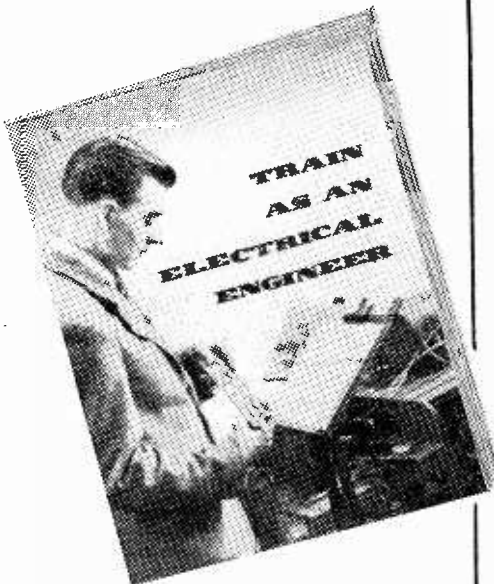

*send for a copy of this booklet
to : Secretary, Dept. PW,
Lancashire Dynamo
Group Apprenticeship Committee.*

LANCASHIRE DYNAMO HOLDINGS LTD

St. Stephen's House,
Victoria Embankment, London, SW1

Facilities for sandwich course training

*Companies in the
Lancashire Dynamo Group*

Lancashire Dynamo Group Sales Ltd.
London, S.W.1.

Lancashire Dynamo & Crypto Ltd.
Trafford Park, Manchester.
Willesden, London, N.W.10.
Irchester, Northants.
Kirkby, Lancashire.

Foster Transformers Ltd.
Wimbledon, London, S.W.19
Leatherhead, Surrey.

Foster Electrical Supplies Ltd.
Wimbledon, London, S.W.19.

Lancashire Dynamo Nevelin Ltd.
Hurst Green, Oxted, Surrey.

Crypton Equipment Ltd.
Bridgwater, Somerset.

Crypto Ltd.
Stonebridge Park, London, N.W.10.

Lancashire Dynamo Electronic Products Ltd.
Rugeley, Staffs.

J. G. Statter & Co. Ltd.
Amersham, Bucks.

Minerva Mouldings Ltd.
Amersham, Bucks.

Dynamo & Motor Repairs Ltd.
Wembley, Middx.
Birmingham, Warwickshire.

Malcolm & Allan (London) Ltd.
London, W.C.2.

Lancashire Dynamo South Africa (Pty.) Ltd.
Johannesburg, S. Africa.

Lancashire Dynamo Central Africa (Pvt.) Ltd.
Salisbury, S. Rhodesia.

Associated Companies

Bepco Canada Ltd.
Montreal, Canada.

Lancashire Dynamo Coates (Pty.) Ltd.
Melbourne, Australia.



PRECISION-BUILT COMPONENTS

JACKSON LGP GEARED DRIVE

This geared drive gives a 9in. pointer travel with only a 3/4in. diameter pulley. The LGP geared drive can be fitted to the standard range of L type condensers. Price LGP2 complete 18/9. LGP3 complete 24/-.

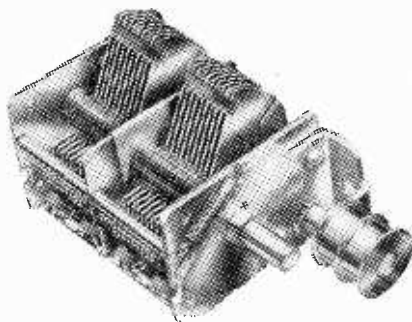

IT'S RELIABLE IF IT'S MADE BY JACKSONS!

Please write for illustrated catalogue.

JACKSON BROS. (London) LTD.

KINGSWAY . WADDON . SURREY

Telephone : CROydon 2754/5

YOU can build any of these at Low Cost!

A MINI TRANSISTOR RADIO

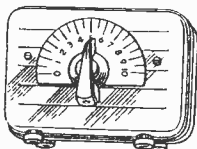

IDEAL XMAS PRESENT

A two-stage highly sensitive circuit uses a new super high gain transistor coil and mini tuning condenser. Gives remarkable performance. With step-by-step instructions. Beginners can't go wrong.

Total building costs **37/6**

Get your order in while prices are low. Send 2/- for wiring diagram and component price list.

includes Plastic case, mini ear-piece, Batteries etc. All parts sold separately.

Ideal for :

- Late night listening.
- Children's nursery, etc.

TRANSISTOR POCKET RADIO



The ideal low cost transistor pocket radio for the beginner. The Two-Stage circuit utilises the new R.C.S. VARILOOPSTICK transistor coil. A specially designed miniature .0005 tuning condenser permits the receiver to be in a case which fits in the palm of your hand. Works for months off

small battery costing 30/-

7d. Can be built in 30 minutes. PRICE

All components are sold separately, full construction data, including plan to parts for 2/-.

1v. WORLDWIDE SHORT-WAVE RADIO

EXPLORE THE WORLD ON SHORT WAVES!

Can be built from our list of components which can all be purchased separately, covers 10-100 metres and is capable of receiving speech and music from all over the world. Price includes the famous 954 acorn valve and one coil covering 40-100 metres. Provision is made to increase to two or three valves and all components are colour coded. Send 2/- for point to point wiring diagram, layout and price list.

30/-

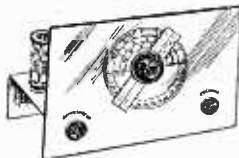

PERSONAL PORTABLE RADIO

THE SET FOR PERSONAL LISTENING

This little set was designed to give you a real personal portable radio that you can listen to anywhere without disturbing others. Use it on camping trips, in bed, in your office. Supplied with detachable rod aerial, it covers all the medium waves 200-500 metres. Average building time one hour. PRICE

30/-

Send 2/- for specification, point to point circuit and parts price list.



Post and packing : Under 10/- add 9d. : under 40/- add 1/6 : over POST FREE.

R.G.S. PRODUCTS (RADIO) LTD., 11, OLIVER ROAD, LONDON, E.17. (Mail Order only)

Open to Discussion



The Editor does not necessarily agree with opinions expressed by his correspondents

Musical Frequency and the Satellite

SIR,—I was very interested to read your article in "Round the World of Wireless" on "Standard Musical Pitch," describing the service given by two short-wave stations for musicians, etc.

At about 10.35 p.m. (G.M.T.) on Tuesday, October 8, I was listening on an ordinary domestic receiver for signals from the Russian satellite. I had listened previously without success, and I did not know that the satellite had ceased to transmit at the time. Imagine my surprise when there, clear as a bell, was an interrupted note sounding right on the satellite's frequency. I left my tape recorder on and then later the note changed. After 20 minutes recording I switched off.

Te-night, when I was replaying the recording, as I couldn't understand what I had been receiving when the satellite was silent, I was amazed to hear a voice announcing that it was station WWV broadcasting the 440 c.p.s. and 600 c/s. tones as you stated in the article.

The satellite has been transmitting on approximately 20 and 40 megacycles/sec., and WWV broadcasts on 20 megacycles/sec. as one of its frequencies. Do you not agree, therefore, that many people, like myself, who thought they were listening to the satellite's signals, have been listening to WWV station? This seems especially true since domestic receivers cannot differentiate between the 20 Mc/s of WWV and the 20,005 Mc/s of the satellite transmitter. I think that this disappointing fact should be made known.—John A. Hawkins (Tamworth).

A New Component Suggestion

SIR,—I wonder if manufacturers of radio wire, tapes and similar materials would please consider making:

1. A conducting wire with an improved magnetic path all around it, such as a plastic insulation containing Ferrox cube dust or powders of various kinds for radio-frequency and Stalloy dust, Mu-metal, or radio-metal, etc., for audio frequency purposes.

2. Plastic tapes containing various ferrous powders for interleaving coil layers when using ordinary insulated wires.

3. A plastic solution and/or cements concentrated with ferrous dusts for painting over

layers of coils or for impregnating purposes and other such uses.

4. An insulated ferrous alloy wire wound around a current conducting wire, or may be you have some better ideas.

The advantages are obvious. Litz wire having each strand insulated with Ferrite plastic is bound to be much more efficient. Any shape of coil, torroidal, etc., can be wound to any desired size diameter or form and it carries with it the correct amount of ferrous dust. Bulk or overall dimensions are bound to be reduced since all the Ferrite is just where it is wanted and all wiring is automatically suitably spaced for best efficiency. In most cases cores and laminations

would be dispensed with. And there are other useful applications for such wires.

There are no patents. My idea is freely given. Please, manufacturers, let me know when you have anything like it, I want some. Comments are welcomed.—R. F. GRAHAM (Bedford).

A Transistor Tester

SIR.—A point of interest concerning the Transistor Test Set (October, 1957), is the lack of provision I have made for the safety of the meters. Fundamentally, of course, the unit is complete, but provision for short-circuited transistors, or accidental shorting of the terminals while switched on, might avert the price of a new meter, microamp or milliamper, or possibly both. This has been pointed out to me by a reader, and I feel that my recommendations to him may be of interest to other readers.

A short circuit between base and emitters might well ruin the microammeter, since if the variable resistance R was set at a low value, the current flowing would be high. With R at a maximum, i.e., 10K Ω , the maximum current that could flow would be about

$$I = E/R \quad I = 1.5 \text{ amps} = 1.5 \times 10^2 = 150 \mu\text{A.}$$

$$10^4$$

This could not, of course, damage the microammeter. Thus before testing a transistor it would be wise to keep R at a maximum and reduce it to a minimum, when it is clear that there is no base/emitter short. The milliammeter may be protected by a series resistor in the collector circuit. A collector/emitter short would cause a heavy current to flow through this meter.

Whilst we are always pleased to assist readers with their technical difficulties, we regret that we are unable to supply diagrams or provide instructions for modifying commercial or surplus equipment. We cannot supply alternative details for receivers described in these pages. WE CANNOT UNDERTAKE TO ANSWER QUERIES OVER THE TELEPHONE. If a postal reply is required a stamped and addressed envelope must be enclosed with the coupon from page iii of cover.

Since the full scale deflection is 10 mA, it is clear that a resistor could be switched in initially to limit the maximum possible current flowing to 10 mA. The instrument would thus never pass more than this value. Assuming a collector/emitter short, the resistor required to limit the collector current to 10 mA would be $R = E/I$ $R = 1.5 \times 10^2 = 150\Omega$. A 150Ω resistor then with a shorting switch can be connected into the collector circuit, either between the collector and the milliammeter or between the milliammeter and the battery.

Instructions for testing a transistor under these conditions would be:

1. Set R to maximum. Switch in 150Ω resistor.
2. Connect up transistor. Switch on.
3. If collector current well below 10 mA, and base current well below $150\mu A$, reduce R to a minimum and short 150Ω resistor.
4. Test transistor as instructed in article.—B. G. Wilkinson (Exeter).

Beginner's Course

SIR.—At last I see you have given us what has for long been wanted. As a complete tyro on radio, I have read dozens of books which are labelled for the beginner, but I can't understand half of them. I don't want to know all about megohms and milliwatts, all I want to do is to make a set, with a fair idea of what I am doing. The Beginner's Course seems the answer, so long as it goes on to decent sets and does not stop at the crystal set. I should like to thank you on behalf of many beginners for this new series, which, I am sure, fills a long-felt want.—H. R. BERTIN (N.W.5).

Tone Formant Wanted

SIR.—I recently completed an electronic organ, in which the output from the generator and dividers is a reasonably good saw-tooth. I have made a number of tone formants for flute, oboe, etc., but have been unable to get a really good tibia tone—something comparable with a pipe organ. I wonder if any reader has found a suitable circuit and would be willing to pass it on? I think this is one of the most fascinating of the electronic hobbies and offers unlimited scope to the keen amateur.—E. M. WATTS (N.W.).

Correspondent Wanted

SIR.—I am thirteen years of age and attend grammar school and would very much like to correspond with amateurs of my own age. I am interested in wireless, especially short wave.—DAVID COO, 279, Louth Road, Scarthoe, Grimsby, Lincs.

Ex-Service Equipment Variations

SIR.—It was with interest and some amusement that I read Rev. C. H. Arnold's letter with special reference to his remarks concerning F.M. and F.M. feeder units. He mentions the "373" I.F. strip conversion which was described recently in PRACTICAL WIRELESS, by "Mark Time." In the article your contributor states that there are seven wires leading to the power-plug as follows:

red and black H.T., brown and grey heaters, and three yellow leads for AVC and bias.

I have two of these units and both have eight leads to the power-plug, the extra wire being blue. There was no circuit diagram with either of these units and I would like to know, therefore, what the blue is for and whether it has any part in the final conversion.—J. POLDEN (Sussex).

R.109A

SIR.—I wonder if there are any readers who have any gen about working the receiver R.109A off A.C. mains.—D. E. JONES, 6, Talybout Road, Llanruist, North Wales.

Indicator Unit 255

SIR.—Could any reader give me some information on the Indicator Unit No. 255? I wish to make a "scope." I have been unable to pick up or buy literature from dealers selling such on surplus equipment.—F. R. CROSSLEY (4, Steele Avenue, Staveley, Chesterfield, Derbyshire).

A Peculiar Fault

SIR.—Reading the letter sent in by Mr. Trail reminds me of the unusual behaviour of a German civilian radio receiver which we had in our barrack room when I was stationed in G.H.Q., B.A.O.R., more than ten years ago.

One evening, while we were listening to the American Forces Network on one of its wavelengths, someone walked into the room, went over to the set and spun the tuning knob. The pointer came to rest by sheer coincidence on the other A.F.N. wavelength and we heard about half a dozen words of the programme repeated. We tried it several times and the same thing happened. Afterwards we found that we could go to the set any time and do this if the same programme was being radiated by the two stations simultaneously.

What could cause a time lag of about five or six seconds? It may be worth while investigating even after all these years, to see whether any of our readers stationed in Germany have experienced it, also.—E. YEATES (Bromsgrove).

A PUSH-PULL GRAMOPHONE AMPLIFIER

(Continued from page 708)

have such a means of checking, it is safer to have R23 with the higher value. If you want to use an output transformer with only a 3 ohm secondary winding, the feedback will obviously have to be taken from this, and then you can safely reduce R23 to 22 K ohm because you will be getting reduced feedback anyway.

The completed amplifier should be checked first of all with the feedback disconnected at "X" in the circuit diagram, and it should be perfectly stable in operation. The feedback is then connected up, and if there is a high-pitched whistie, the connections to the output transformer secondary winding should be reversed, as one way round, positive, instead of negative feedback is applied. This is the only setting-up operation required.

THE MULTIMINOR

The "Avo" tradition of pioneering enterprise again finds expression in a new multi-range meter of compact size, robust construction, and thoroughly sound design.

It is a rectifier moving coil instrument, simple to use, easy and quick to read. A single rotary switch selects any one of the 19 ranges. One pair of connection sockets deals with any measurement. One scale is provided for current and voltage readings and another for resistance.

19 RANGES

D.C. Voltage	A.C. Voltage
0—100 mV.	0—10 V.
0—2.5 V.	0—25 V.
0—10 V.	0—100 V.
0—25 V.	0—250 V.
0—100 V.	0—1,000 V.
0—250 V.	
C—1,000 V.	D.C. Current
	C—100 μ A
	C—1 mA
	C—10 mA
	C—100 mA
	C—1 A

Sensitivity :
10,000 Ω /V on D.C. voltage ranges.
1,000 " " A.C. " " " "

Accuracy :
On D.C. 3% of full scale value.
On A.C. 4% " " " " " "

List Price :

£9' 10s.

Designed and Manufactured by

AVO Ltd.

complete with Test Leads and Clips.

AVOCET HOUSE

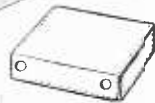
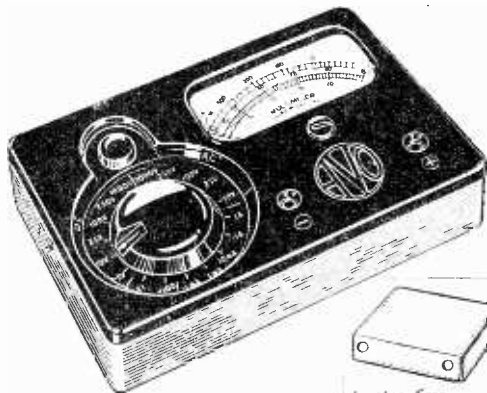

Pocket size: 5 1/2 x 3 1/2 x 1 1/2 ins.
Weight: 1 lb. approx.

Leather Case if required 32/6

a Great little **AVO** Instrument

Telephone: VICTORIA 5404 (9 lines)

92-96 VAUXHALL BRIDGE RD. LONDON S.W.1

VALVES • SAME DAY SERVICE

All Guaranteed New and Boxed

1.4v. midget, 1R5, 1S5, 1T4, 384, DAF91, DF91, DK91, DL92, DK92, DL94, ANY 4 for 27.6	12.6 B36	20. EF38	6. PCF82	11.6
1A7GT 12.6	6L18 12.6	6B36 12.6	6. PCF82 11.6	
1C5GT 15.8	6Q7GT 9.6	6CL33 16.9	9.6 PCL82 12.6	
1H5GT 11.6	6SN7GT 7.6	6F42 10.6	10.6 PCL83 9.6	
1N5GT 11.6	6U4GT 12.6	6F50 6.6	6. PEN46 6.6	
1R5 8.6	6V6G 7.6	6DAC32 11.6	6.6 PL38 22.6	
1S5 7.6	6V0GT 7.6	6DAF36 8.6	9.6 PL81 12.6	
1T4 7.6	6X4 7.6	6DF33 11.6	8.6 PL82 9.6	
3Q4 8.6	6X5GT 6.6	6DF96 8.6	6EF85 7.6	10.6
3Q5GT 9.6	6Y6 10.9	6DH76 7.6	6EF86 11.6	6PY80 8.6
3S4 7.6	6Y7 8.6	6DH77 8.6	6EF89 9.6	6PY81 8.6
3V4 8.6	6Y8 8.6	6DK32 12.6	6EF91 6.6	6PY82 7.6
5U4 9.6	6Y86 8.6	6DK92 8.6	6EF92 5.6	6PY83 9.6
5V4 11.9	6Y87 8.6	6DK96 9.6	6EL32 5.6	6PZ30 13.6
5Y3GT 7.6	6Y87 9.6	6DL33 9.6	6EL38 22.6	6SF41 3.6
5Z4 9.6	6Y87 8.6	6DL35 15.6	6EL41 9.6	6SF61 3.6
6AB8 7.6	6ZAH8 9.6	6DL96 8.6	6EL42 10.6	6U25 12.6
6AR5 4.6	6ZAT7 5.6	6DM70 8.6	6EL84 9.6	6U26 12.6
6AL5 6.6	6ZAU7 7.6	6EAB80 7.9	6EM34 18.6	6U50 7.6
6AM5 5.6	6ZAX7 8.6	6EAF42 10.6	6EM80 10.6	6U76 7.6
6AM6 6.6	6ZBA6 8.6	6EB91 6.6	6EY51 9.9	6U78 7.6
6AQ5 7.6	6ZJGT 10.6	6EBC33 7.6	6EY86 10.6	6UABC80 9.6
6AT8 8.6	6ZKTGT 7.6	6EC41 9.6	6EZ40 7.9	6UAF42 10.6
6BA8 7.6	6ZKGT 14.6	6EB90 8.6	6EZ41 9.6	6UBC41 8.6
6BE8 7.6	6ZQGT 7.6	6EBF89 9.6	6EZ80 7.6	6UBF80 9.6
6BJ6 7.6	6Z23 7.6	6ECC81 8.6	6EZ81 9.6	6UCH42 8.6
6BR7 8.6	6Z5LGT 9.6	6ECC82 7.6	6GZ32 12.6	6UF41 8.6
6BW6 7.6	6Z5ZGT 9.6	6ECC83 8.6	6KT33C 8.6	6UF89 10.6
6BW7 9.6	6Z6GT 9.6	6ECC84 10.6	6KT44 6.6	6UL41 9.6
6CH8 7.6	6Z5LGT 9.6	6ECC85 9.6	6KT61 14.6	6UL84 9.6
6F1 15.6	6Z5ZGT 9.6	6ECC86 10.6	6KT63 6.6	6UY21 15.6
6F8G 6.6	6Z5ZGT 7.6	6ECC87 11.6	6KTW61 6.6	6UY41 7.9
6F12 6.6	6Z5ZGT 13.6	6ECC88 14.9	6MH4 6.6	6UY85 7.6
6F13 13.6	6Z5ZGT 8.6	6ECC89 9.6	6MU14 8.6	6VP41 7.6
6F15 14.9	6Z5LGT 8.6	6ECC89 8.8	6N18 8.6	6W76 7.6
6J6 5.6	6Z5LGT 8.6	6ECC81 8.6	6N78 12.6	6W77 5.6
6K7G 4.6	6AC/TP 20.6	6ECL80 8.6	6PCC84 8.6	6X79 11.6
6KGT 6.6	6AZ31 11.6	6EF37A 8.6	6PCF80 8.9	6Y63 6.6
6K8G 7.9				777 6.6

Postage 6d. per valve extra.

Any Parcel Insured Against Damage In Transit 6d. Extra.

READERS RADIO

24, COLBERG PLACE, STAMFORD HILL, LONDON, N.16 STA. 4587

MAYCO ELECTRIC CO.

Now in Stock

The New STIRLING F.M. TUNER

£13 - 13 - 0

Retail

Complete with its own power pack and polished wooden cabinet. Nothing else to buy. Will work with any amplifier, record changer, radio or gramophone. Full clear instructions with each tuner. Fully guaranteed.

Also in Stock

STIRLING I.T.A.-B.B.C. TELEVISION CONVERTER

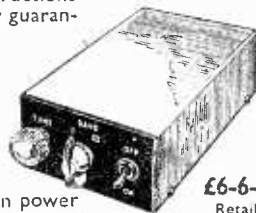









£6-6-0

Retail

Complete with its own power supply. Easily fitted. Guaranteed with Full Instructions.

Cash with Order. We pay the postage.

MAYCO ELECTRIC CO., 43 Rosebery Avenue LONDON, E.C.1. TEL.: 8355-5958.

<h3>High "Q" Coils</h3>  <p>4/- EACH Iron dust cores. Clip in fixing. EXTREMELY SMALL AMAZING EFFICIENCY For Superhet T.R.F. or Transistor operation.</p>	<h3>Potted Coils</h3> <p>Iron dust cores, clip-in fixing.</p>  <p>5/- EACH THE LATEST in modern technique. Ideal for crystal tuners.</p>	<h3>All coils for Collaro Tape</h3> <p>Transcripator pre-amp.</p>  <p>BIAS OSC. Coil 7/6 Type QT9</p>	<h3>STATION SEPARATOR</h3> <p>HOME-LIGHT-THIRD-LUX ETC.</p>  <p>10/6 Not a guaranteed cure but — A positive answer to selectivity problem.</p>	<h3>STOP! T.V. Patterning</h3> <p>10/6</p>  <p>An easily fitted— Simple Remedy</p>
<h3>FERRITE Rod Aerials</h3> <p>MW 8/9 M-LW 12/6</p>  <p>Also Flat wound High 'Q' frame aerials MW 2/6 each LW loading 4/-</p>	<h3>I.T.A. Converter</h3> <p>To fit inside T.V.</p>  <p>65/- complete £4 Very efficient. Can be built in an evening. Full instructions etc.</p>	<h3>Dial assembly for OSMOR Coils</h3> <p>24/6 complete Escutcheon in bronze finish 4/- Other dials 5½ x 5½ 3/6 each includes spot markings for trawler band.</p> 	<h3>OSMOR (Frequency Controlled) F.M. Switch-tuned Feeder.</h3> <p>Dimensions 4½" x 4½" (5½" deep). A completely stable drift-free unit for adding to existing radio or Hi-Fi amplifier. EASY TO BUILD. Wiring diagram & circuit on request.</p>	

OSMOR COILS FREE!
ARE BEST FOR
Selectivity & Performance

Send 10d. (stamps) for fully descriptive literature including OSMOR DESIGNS—5-Valve S'Het, Miniature ditto, Battery and Battery/Mains Receiver, Mains T.R.F. S'Het and T.R.F. Feeders. Band 3 Converters, Wiring Diagrams, Chassis Templates, Coil & Coilpack information and price lists and information on circuits in "Wireless World," "Practical Wireless," "Radio Constructor." Full Circuits included. See also Classified Advs. on page 740



(Dept. PW 17) 418 BRIGHTON ROAD,
SOUTH CROYDON, SURREY
CROYDON 5148/9

MULTIMETER KIT. 23 A.C./D.C. Ranges for your 1 mA. meter. Volts A.C./D.C. up to 500; mA. up to 1 Amp.; three ohms ranges up to 5 Meg. Kit comprises 1". High Stability. Wirewound, shunt resistors; ohms zero control, rectifier, circuit instructions. 38-. Switches 11/- extra.

PRECISION WIREWOUND RESISTORS. Eureka wound on strip; 1 to 1,000 ohms. 0.5%, 3/-; 0.2%, 4/3; 1K to 5K, 0.5% 3/6; 0.2%, 4/9; 5K to 20K, 0.5%, 4/3; 0.2%, 6/-; 1% tolerance at 0.5%, prices less 3d.. The above have low inductance value and are suitable for use at all audio frequencies. Your value wound to order.

RESISTORS FOR RESISTANCE BOXES. 12 Wirewound resistors. 1, 2, 2.5, 10, 20, 20, 50, 100, 200, 200 and 500 ohms to give any value between 1 and 1,110 ohms in 1 ohm steps. 0.5%, 33/-; 0.2%, -0.01 ohm, 48/-; Ditto, but 10 to 1,100 in 10 ohm steps. 0.5%, 34/-; 0.2%, 49/6. Ditto, but 1 to 1,110 in 1 ohm steps (16 resistors). 0.5%, 45/-; 0.2%, -0.01 ohm, 65/-. Ratio Arm Resistors 10, 90, 900 ohms, set of six to give ratios 10, 10, 1.0, 0.01 to 1, 0.5%, 16/6; 0.2%, 24/-.

1% HIGH STABILITY RESISTORS. Any value from 100 ohms to 1 Megohm, including non-standard values 1w., 2/3.

1% SHUNT FOR 1 mA 100 ohm METER. Ranges 10, 100, 1,000 mA., 7/6.

1% SHUNT FOR 500 µA 500 ohm METER. Ranges 5, 50, 500 mA., 7/6.

1% SHUNT FOR 100 µA 1,000 ohm METER. Ranges 10, 100, 1,000 mA., 7/6.

1% SHUNT FOR 5 mA. 20 ohm METER. Ranges 50, 500 mA., 2.5 A., 7/6.

Shunts for any meter with ranges to your specification. Reasonable prices.

SWITCHED DECADE RESISTOR UNITS. Yaxley type switch with wirewound resistors mounted. 100 ohms 1% in ten 10-ohm 1% steps. 17/6; ditto, but 1,000 ohms max., 17/6; ditto, but 10,000 ohms max., 20/-.

Postage extra. S.A.E. with enquiries, please.

TRANSISTOR CIRCUITS

22s. Postage 9d.
by R. P. TURNER

TAPE RECORDERS & TAPE RECORDING. By H. D. Weiler. 30s. Postage 10d.

THE OSCILLOSCOPE AT WORK. By A. Haas & R. W. Hallows. 15s. Postage 10d.

TELEVISION ENGINEERS' POCKET BOOK. By E. Molloy & J. P. Hawker. 10s. 6d. Postage 8d.

4TH EDITION REFERENCE DATA FOR RADIO ENGINEERS. By I. T. & T. Corp. 50s. Postage 1/9.

TELECOMMUNICATIONS: PRINCIPLES & PRACTICE. By W. T. Perkins. 21s. Postage 9d

G.E.C. VALVE MANUAL (Part I). 7s. 6d. Postage 1/-.

TELECOMMUNICATIONS. By W. Fraser. Introductory Textbook for Engineering Students. 65s. Postage 1/6.

RADIO VALVE DATA. By "VW." 5s. Postage 9d.

THE MODERN BOOK CO.

BRITAIN'S LARGEST STOCKISTS of British and American Technical Books

Complete catalogue 6d.
19-23 PRAED STREET, LONDON, W.2
Phone: PADDINGTON 4185
Open 6 days 9-6 p.m.

BENSON'S BETTER ARGAINS

RELAYS. co-axial, types "F" or "G," 12 v. 10 - plus to fit. 1/6 set. Type 85: 5 pole changeover, 6 12 v. Heavy duty contacts, 7 6 (post each 2 6).

TEST SETS: 7A with 10 valves, V.C.R., 100a and 50 cycle power pack; fair condition. 50 - (curr. 8/6). Type 5B, with 2 valves and 1 mA. meter, new 35 - (curr. 5/-). Wavemeters, 100 250 mcs. with 2 valves, 1 mA. meter, new, grey crackle, 40 - (curr. 5/-). Transceivers, V.H.F. 10 valves, 50 cycle power pack, new, 45 - (curr. 8/6). ECI008 V.H.F. Receiver, valves 2 957, 1FD8GT, new, 15 - (post 3/6). TRANSFORMERS: Ratio Pri. 3.5:1 (two sees. Potted 4 -), ditto 1.5:1 open, 4 - . Pri. 50 v. 50 v. to 10, 15, 20, 25, 30, 50 v. 2A, 7/6 (post 2/6). "C" core: 220 v. in; outputs: 210-0-215 v., 60 mA., 5 v. 2 a, 6.3 v. 1.5 a., 25 - (4p. 3/6). Input 200 250 v. Outputs: 12 v., 3a., & 5v., 2A, 12 6; 2-0-0-200v. 200mA. & 4v. twice, 17 6. Transmitter Receivers No. 18, with valves, 50 - (less attachments, curr. 7/6). CAR RADIO (Command Receiver, Medium wave) circuit and modification data. 1 6. COMMAND RECEIVERS, brand new, with 6 valves, B/451, 3/6 mcs., 45 - . Med. wave 0.2-1.5 mcs., 97 6. used 82 6 (post 3/6). Vibrapacks, 6 v. D.C. to 180 v., 50 mA., smoothed, cased, 22 6 (post 3/6). INDICATOR UNITS, new, with VR97, 3VTR91, 2 VY18, 2 VRS4, 24 - (curr. 7/-). Responder Z/8951, 100 190 mcs. with valves, 15 - (curr. 7/6). VIBRATORS, Maltby 629C 12 v. 4 pin, 7 6. THROAT MICS., New, 2 6. BRAND NEW RF 26, 27, 25 - (post 3/3). RP25, 10 6. RP26, 27 good cond. 20 -. DYNAMOTORS (post 3/6): 12 v. to 250 v. 65 mA., and 6.3 v. 2.5 A., 11 6; 6 v. to 250 v. 80 mA., 12 6. 12 v. to 200 v. 75 mA., cased, 15 - . METAL RECTIFIERS: 200 v. 100 mA., 4 - 240 v., 30 mA., 3 6. 1,000 v. 20 mA., 7 6. 120 v., 2 A. Bridge, 30 -. R155 S.M. TUNING DRIVES "M" type, brand new, 10 6. CHOKES, L.F., 10H, 120 mA., screened, 7 6. 10H, 80 mA. 7 6. 5H, 200 mA., 4 6. SWITCHES, water, 1p 6w 5b 2 6. 1p 11w 2b, 6p 2a 4b, 3 6. 1p 11 v ceramic, 2 6. Stud type, Muirhead 1P-1VW, 7 6.

LIST AND ENQUIRIES—S.A.E. please 1 Terms, C.W.O. Postage Ex. Immediate despatch

Call or post: W. A. BENSON (P.W.)
138, Rathbone Road, Liverpool 5. S.E.P. 6330
Callers: SUPERADIO (W'chapel) LTD.,
116, Whitechapel, Liverpool, 2. R/O 1130.

PLANET INSTRUMENT CO.
25, DOMINION AVE., LEEDS, 7.

Programme Pointers

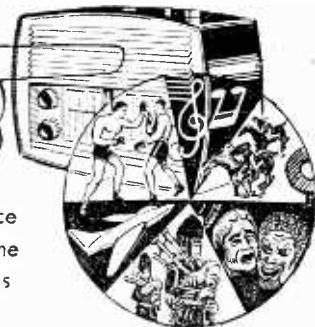

A Fall in Listeners

A LARGE fall in wireless listening figures, even if less catastrophic than was at first reported, gives cause for thought and arouses serious reflection. What are the reasons? Leaving aside television competition (the worst effects of which may only be temporary and may not last beyond the novelty stage of the new medium) and keeping strictly to radio broadcasting, my own reflections are as follows:

Thousands have grown sick and weary of constantly being "talked down to"; they are tired of comedians and some others summoning them, and the whole nation, to the microphone with a portentousness worthy of more important things and with a signature tune that grows more nauseous with every weekly repetition; they are sick of the endless "credits" at the end of each show, every word of which is in the "Radio Times"; they are annoyed with much poor material at the peak hours of broadcasting; they are weary of the repetitiousness of announcing and of many programmes; they resent the weather forecasts, a high percentage of which are very untrustworthy, and they consequently feel frustrated, "taken for a ride," taken too much for granted. They think, and rightly, that things could, and should, be much better than they are.

Whether television will succeed in keeping all those who are at present turning to it for relief and change is at least debatable. But if the fall in blind radio listening gives its purveyors a good rousing and shaking-up, much benefit should accrue.

French Revolution

Sardou's late Victorian pastiche of sex and history—with probably more of the former than the latter—"Madame Sans-Gene" (real name Catherine Hubscher) made good entertainment, though it was presented without conviction or historic colouring. The "effects," Marseillaise sung *not* by revolutionary mobs, firing, "down with the aristocrats," etc., can be discounted as they are the standard background to all French Revolutionary stories. Miriam Karlin played the laundress Katherine, who marries Sgt. Lefebvre and who, when that unworthy is ennobled, becomes Duchess of Dantzig and twists the easily twistable Napoleon round her little finger, with some charm and a realisation of the character. But Noel Johnson, as Napoleon, was never for one moment either a Corsican by birth or an Emperor by usurpation, though we were grateful that he didn't play the part in pidgin-English. The remainder of the cast were: R. Hurdnall, R. Delgado, T. Martin, Kathleen Helme, Violet Loxley, Virginia Winter and M. Hayes. Translators, Norman Ginsbury and John Sand. Producer, Wilfred Grantham. But Corno di Basetto's description of the play, sixty-odd years ago, as "Sardoodledum" is definitive.

Our Critic, Maurice
Reeve, Reviews Some
Recent Programmes

The Egoist

On the other hand, Jean Morris's adaptation of Meredith's beautiful novel, "The Egoist," was much more satisfactory. To start with, of course, the Englishman was a much greater writer than the Frenchman. The acting made the story and the characters sound a bit too much like Sunday evening Trollope, but it was very enjoyable, none the less. Cast: Lydia Sherwood, Peggy Thorpe-Bates, Hestor Paton Brown, P. Wyngarde, Hilary Mason, Clare Austin, C. Hobbs, F. Windsor, W. Fox, R. Willett and T. Martin. Producer, Mary Hope Allen.

Birds in Britain

Birds in Britain, edited and introduced by James Fisher, is a delightful programme, taking us back to the charm and fascination of the things that matter and which are all around us if we take the trouble to look for them. The last one I heard was of the birds of St. Kilda. Mr. Fisher is an expert at such things, nor must we forget the producer, Winwood Reade.

Alistair Cooke

Alistair Cooke, on gramophone records, "played, sung, whistled and talked about some of the music that has given him pleasure"—albeit lowbrow—in a charming quarter of an hour.

Third Listening

Mary Hope Allen's adaptation of Henry James's novel, "The American," made stimulating and entertaining "third" listening. David Knight, Rachel Gurney, Gladys Young, Roger Delgado and Kathleen Helme headed a long cast. But oh! those American accents!

Famous Trial

"The Trial of Madeleine Smith" was a dramatisation of a famous trial for murder exactly one hundred years ago. Consisting almost entirely of three characters, the prosecution, the defence and the narrator, it lacked dramatic variety in consequence. Three other members in the cast, including the accused girl herself, were very minor. The story of the trial, concluding with Madeleine's acquittal, was exciting enough. It was instructive to note the omissions in the defence the instant the prosecution seized upon them. Cast: Bill Crichton, Ian Stewart, James McKechnie, Claire Isbister, Helena Gloag and Edith Macarthur. Play by John Gough.

A WONDERFUL MONEY-SAVING OPPORTUNITY FOR READERS OF PRACTICAL WIRELESS!



Now's the time to join the
SCIENTIFIC BOOK CLUB

You BUY Books published at 10/6, 12/6 and more—for **ONLY 4/-**

FULL LENGTH FULL SIZE

The Scientific Book Club is owned and controlled by Foyles, the world-famous book sellers.

LOOK AT THESE GREAT TITLES!

Recent and forthcoming selections include:

INSIDE THE ATOM

By Isaac Asimov
Published at 12s. 6d.
4s. TO MEMBERS

AUTOMATION: ITS PURPOSE & FUTURE

By Magnus Pyke
Published at 16s.
4s. TO MEMBERS

WINDOW IN THE SEA

By Ralph Nading-Hill
Published at 13s.
4s. TO MEMBERS

SCIENCE UNFOLDS THE FUTURE

By J. G. Crowther
Published at 18s.
4s. TO MEMBERS

Each month, the Scientific Book Club brings to its members the fascinating story of the march of modern science, told in thoroughly dependable books by the front-rank scientific writers of our time—vivid, vital, constructive contributions to Man's unceasing struggle to solve the problems of the Universe. And although the ordinary editions of these books are sold to the general public at 10/6, 12/6 15/-, or more, THE PRICE TO MEMBERS OF THE SCIENTIFIC BOOK CLUB IS ONLY 4/-. Remember, too, that Scientific Book Club selections are full-length and unabridged. They are printed on good quality paper, well bound, with an attractive picture jacket. These are, we say with certainty, books that you will be glad to read, proud to own. The Scientific Book Club brings these great books to you each month; helping you to build up, at remarkably low cost, a first-class collection of scientific books. *Now is the time to join!*

FREE! You can obtain the famous **CONCISE OXFORD DICTIONARY** (published at 18s.) FREE if you enrol a friend in the Club. Send your friend's name and address with 5s. (4s. plus 1s. postage) for first book, mentioning this offer, and your gift will be sent to you.

—FILL IN THIS ENROLMENT FORM TO-DAY!—

To The Scientific Book Club, 121 Charing Cross Road, London, W.C.2

I wish to join the Scientific Book Club, and agree to purchase the book issued each month to members at a cost of 4s. (postage 1s.). I agree to continue my membership for a minimum of six books and thereafter until countermanded.

Prac. Wireless/Dec. '57.

- *I will pay for selections on receipt.
Or if you wish to save time, postage and postal order costs you may send an advance subscription. 6 months 30s.; 12 months 60s.
- *I enclose 30s./60s. (Strike out amount not applicable.)
* Place ✓ in the space above, as required.

NAME
(Block letters, please)

ADDRESS

Overseas enrolments (prices as for inland) should be accompanied by an advance subscription.

FOR THE BEST VALUE in TAPE RECORDERS

... we recommend the



55 GNS.

or 55/- deposit

NO INTEREST TERMS

4 watts output—3 hours playing time—3 speeds. Completely automatic operation. All other makes of Tape Recorders in stock.

Write for details to:—

E & G THE RADIO CENTRE
33, Tottenham Court Rd., London, W.1
Telephone: MUSEum 6667

CHASSIS

Let us supply the chassis for your set. We are specialists in this field and actual makers of aluminium chassis. Supplied either plain or with the large and awkward holes already drilled. We can also supply covers and cabinets in metal, clips for rectangular shaped condensers, and mumetal screens of all types.

UNDRILLED ALUMINIUM CHASSIS

4 sides, welded corners.

7in. x 4in. x 1 1/2in. deep	... 4/3 ea.
9in. x 6in. x 1 1/2in. deep	... 5/6 ea.
11in. x 7in. x 1 1/2in. deep	... 6/6 ea.
10in. x 8in. x 2 1/2in. deep	... 7/- ea.
16 1/2in. x 8 1/2in. x 2 1/2in. deep	... 9/- ea.

2 sides only.

7in. x 4in. x 2in. deep	... 3/- ea.
9in. x 6in. x 2in. deep	... 4/- ea.
10in. x 8in. x 2 1/2in. deep	... 4/9 ea.
16 1/2in. x 8 1/2in. x 2 1/2in. deep	... 6/9 ea.

Prices are subject to postage being charged extra.

Send sketch of your requirements for prices by return to:—

Oliver & Randall LIMITED
53 Perry Hill, London S.E.6

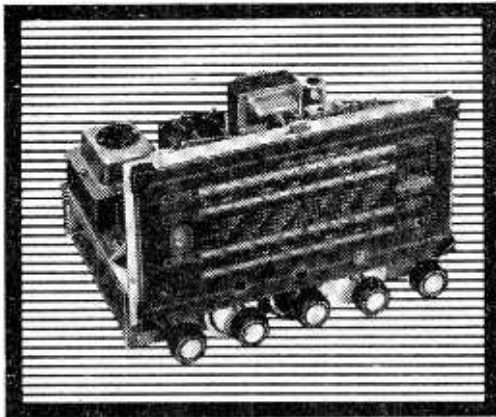

Model H3. Three waveband model (inc. VHF), 6 valves for 3 ohm. speaker. Chassis immensely sensitive and stable, giving highest quality reproduction. Wide range Tone Control, with pick-up, extension speaker and gram motor sockets. **£20. 17. 0 inc. P.T.**



HIGH FIDELITY AT ITS FINEST

◀ **Model H4PP.** NEW! A complete Dulci High Fidelity radiogram chassis, combining sensitivity, selectivity and stability to delight the most discerning listener. Outstanding record and VHF reproduction, 4 wavebands. Ultra linear amplifier gives ample power output. Push-pull system, wide frequency response, bass and treble controls. Fits easily into any existing cabinet. The perfect chassis for modernising your radiogram.

AM/FM Model H4PP. Price: **£29. 3. 10 inc. P.T.**

Model H4. AM/FM Radiogram chassis. 7 valve, 4 waveband superhet with FM (VHF). Magic eye tuning indicator. High sensitivity. Dial size 11 1/2" x 5 1/2". Sockets for speaker (3 and 15 ohm.). Mains for motor. **£24. 6. 6 inc. P.T.**

Write for full details

distinctly **DULCI** quality products

THE DULCI COMPANY LTD., 97-99 VILLIERS ROAD, LONDON N.W.2.

Telephone: WILlesden 6678/9

FREE TO AMBITIOUS ENGINEERS!

This 148-page Book

Have you sent for your copy?



'ENGINEERING OPPORTUNITIES'

is a highly informative guide to the best-paid Engineering posts. It tells you how you can quickly prepare at home on "NO PASS—NO FEE" terms for a recognised engineering qualification, outlines the widest range of modern Home-Study Courses in all branches of Engineering and explains the benefits of our Employment Dept. If you're earning less than £18 a week you cannot afford to miss reading this unique book. Send for your copy to-day—FREE.

WHICH IS YOUR PET SUBJECT ?

- Mechanical Eng.
- Electrical Eng.
- Civil Engineering
- Radio Engineering
- Automobile Eng.
- Aeronautical Eng.
- Production Eng.
- Building, Plastics, Draughtsmanship, Television, etc.

GET SOME LETTERS AFTER YOUR NAME!

- A.M.I.Mech.E.
- A.M.I.C.E.
- A.M.I.P.E.
- A.M.I.M.I.
- L.I.O.B.
- A.F.R.Ae.S.
- B.Sc.
- A.M.Brit.I.R.E.
- CITY & GUILDS GEN. CERT. OF EDUCATION etc., etc.

--- FREE COUPON ---

Please send me your FREE 148-page "ENGINEERING OPPORTUNITIES"

NAME
ADDRESS

Subject or Exam. that interests me.....

British Institute of Engineering Technology, 509 B, College House, 29-31, Wright's Lane, Kensington, W.8.

BIET

SOUTHERN RADIO'S WIRELESS BARGAINS

TRANSRECEIVERS. Type "38" Mark II. Just arrived, new purchase. New condition, 5 valves, in case, less attachments, 37/6.
ATTACHMENTS for Type "38" Transreceivers. ALL BRAND NEW. Headphones, 15/6; Throat Microphones, 4/6; Junction Boxes, 2/6; Aerials No. 1, 2/6; No. 2, 5/-; Webbing, 4/-; Haversacks, 5/-; Valves—A.R.P.12, 4/6; A.T.P.4, 3/6. Set of FIVE VALVES, 19/- set.
TRANSRECEIVERS. Type "18" Mark III. Two Units (Receiver & Sender). Six Valves, Microammeter, etc., in Metal Carrying Case. Untested, without guarantee but COMPLETE. £2.18.6.
ATTACHMENTS for "18" Transreceivers. ALL BRAND NEW. Phones, 15/6; Microphone, 12/6; Aerials, 5/- Set of SIX VALVES, 30/-.
RECEIVERS R109. S.W. Receiver in Case. 8 valves. Speaker and 6-v. Vibrator Pack. Untested. No guarantee but COMPLETE, £2.18.6.
RESISTANCES. 100 Assorted useful values. New wire end, 12/6.
CONDENSERS. 100 Assorted. Mica, Tubular, etc., 15/-.
BOMBSIGHT COMPUTERS. Ex-R.A.F. NEW. Hundreds of Components, Gears, etc. Ideal for Experimenters. £3.
LUFBRA HOLE CUTTERS. Adjustable 2in. to 3 1/2in. For Metal, Plastic, etc., 7/-.
QUARTZ CRYSTALS. Types F.T.241 and F.T.243. 2-pin, 1/2in. Spacing. Frequencies between 5 675 kcs. and 8 650 kcs. (F.T.243.) 20 Mc/s and 38.8 Mc/s (F.T.241, 54th Harmonic), 4/- each. ALL BRAND NEW. TWELVE ASSORTED CRYSTALS, 45/- Holders for both types, 1/- each. Customers ordering 12 crystals can be supplied with lists of frequencies available for their choice.
MORSE TAPPERS. Standard type, 3/6; Extra Heavy on Base, 5/6; Midget, 2/9.
TRANSPARENT MAP CASES. Plastic, 14in. x 10 1/2in. Ideal for Maps, Display, etc., 5/6.
DINGHY AERIALS. Ex-U.S.A. Reflector Type, 4/6.
STAR IDENTIFIERS. Type I A-N covers both Hemispheres, 5/6.
CONTACTOR TIME SWITCHES. 2 Impulses per sec., in case, 11/6.
 Postage or Carriage extra. Full List of RADIO BOOKS, 3d.
SOUTHERN RADIO SUPPLY LTD.
 11 LITTLE NEWPORT ST., LONDON, W.C.2. GERRARD 6653

RECEIVERS & COMPONENTS

ONE COMPLETE ex-R.A.F. airfield G.E.C. speech Broadcasting Unit, total output 1,080 watts from 6 180-watt output units; complete with priority relay panel and emergency equipment; all in good condition, but less valves; price £200, ex-works. o.n.o. **WHITETRADE LIMITED**, Maidstone Rd., Rochester. (Chatham 4638.)

Elstone Transformers from M. FOY.

NEW and used Valves and Components at low prices; all guaranteed; s.a.e. list. Service Sheets, s.a.e. enquiries, **J. PALMER (PW)**, 32, Neasden Lane, London, N.W.10.

ATTENTION! The famous Sonomag "Adaptatape" pre-amplifier is now fitted to the Collaro MK. TV Tape deck and now incorporates push-pull oscillator, complete with power pack, 38 gns. Easy terms and full specification on request. **SOUND TAPE VISION**, The Tape Recorder and Hi-Fi Specialists, 71, Praed Street, London, W.2. (PAD 2807.)

TAPESOUNDING. Exchange tape recorded messages home/overseas. Details **EWART**, 87, Terrace, Torquay.

SERVICE MANUALS/SHEETS. Tel/Radio for hire, sale and wanted. S.A.E. enquiries, **W. J. GILBERT (P.W.)**, 24, Frithville Gardens, London, W.12.

Replacement Components from M. FOY.

T.V. TUBES, 30/., with cathode heater shorts; 45/., with burn; carr. extra. Ideal for testing; good picture; all types and sizes. Please enquire. **DUKE & CO.**, 623, Romford Rd., Manor Park, E.12. (GRA 6677.)

"OSMOR NEWS." Components lists for "P.W." Consul Car Radio, "P.W." "The Chorister" and "R. Constructor," "Beginners S. Wave 1 Valver" on request. **OSMOR**, 418, Brighton Rd., S. Croydon. (CRO 5148.)

MIDDLESBROUGH. Largest stocks on N.-East coast. Radio, TV components, FM Kits, Gram. Cabinets, Tape Decks, Leak Amplifiers, Valves, etc. Callers only. **PALMERS**, 106, Newport Road. (Phone: 3096.)

MAKING YOUR OWN? Telescopes. Enlargers, Projectors, or in fact, anything using lenses. Then get our booklets "How to use Ex-Gov. Lenses & Prisms," price 2/6 ea. Comprehensive lists of optical, radio and scientific equipment free for s.a.e. H. W. **ENGLISH**, Rayleigh Rd., Hutton, Brentwood, Essex.

SERVICE SHEETS FROM M. FOY.

BARGAIN-TEST INSTRUMENTS.—I have available: Cossor 339A Double Beam Oscilloscope, £18. Taylor 45A Valve Tester, complete with up-to-date adaptors, £9/10/-. Metrix Model 430 Multi Meter, 20,000 o.p.v., brand new, £18/10/-. Triplett AM/FM Signal Generator, Model 3433 (110v. A.C.), 100 Kc/s-120 Mc/s in 10 ranges, 240 Mc/s on harmonic, £20. Telegonomet Model WG4 T.V. Pattern Generator, £20. G.E.C. Frequency Meter, 0-45 Kc/s in 4 ranges, rack mounting, £6/10/-. Taylor Model 190A Audio Oscillator, 20 c/s-20 Kc/s—£10. Funke Field Strength Meter with antennae, 45-230 Mc/s with meter calibrated 0-500 uV. (battery operated), £12/10/-. Taylor Model 260A T.V. Wobulator combined with Oscilloscope, 10 Mc/s-70 Mc/s on fundamentals, £19/10/-. Webster Portable Tape Recorder, £22. All instruments are in good or excellent condition with manuals and accessories. Apply, **E. STRAUSS**, 5, Gloucester Avenue, South, Bucks.

RATES: 5/6 per line or part thereof, average five words to line, minimum 2 lines, Box No. 1/- extra. Advertisements must be prepaid and addressed to Advertisement Manager, "Practical Wireless," Tower House, Southampton St., Strand, London, W.C.2.

BRAND NEW 38 Sets. The Army's Famous Walky Talky, complete with 5 valves, throat microphone, headphones and junction box, 39/6, p. and p. 3-. **ELECTROSURE**, 120, Fore St., Exeter SE6887.

LOUDSPEAKERS repaired promptly. **MODEL LOUDSPEAKER SERVICE**, Bullington Rd., Oxford.

VALVES, 6SN7GT, 6Q7GT, 5/- each. Various Transformers, Valve-holders, Resistors and Caps. S.A.E. for list. **PRESTO SUPPLIES (PRESTON)**, 145, Hammond St., Preston. (Tel.: 56753.)

POWER IN PACKETS. Note new prices due to postal increases. 37 x 64 x 4 1/2, 10/9; 120v. small, 2/4; 5 for 8/9; 105 x 1 1/2, 10 for 8/6; 67 1/2, 4/6; 90 x 45 x 3 x 1 1/2, 6/9; 22 1/2, 2/4, 6 for 10/9. Transformers, ex Navy, 230v. Prim. 500-0-500 at 80 mls. 250-0-250 at 220 mls. 70-0-70 at 50 mls. 24/- ea.; 230/6.3 at 9 amp., 6.3 at 2 amp., 4v., at 5 amp., 24/- each. **DIGGINS**, 129/131, Radnor Street, Manchester, 15.

ANNAKIN

BENDIX TRAX, TA12G—300 kc/s-9 mc/s in 4 bands, 7 valves. A bargain at £5/15/-.

105V. R28-ARC/5—100-150 mc/s, 10 valves. With relays, motor, etc. Cheap at £2/10/-.

A.F. OSCILLATOR TRANSFORMERS, 2-20K, for electronic organs, etc. New. Boxed, 1/6.

INERA RED IMAGE CONVERTORS—O.K. but with loose dehydrating crystals, 6/-, Or with faulty caesium cell and sold for the 2 lens only, at 3/-.

TANNOY METAL HANDSET—Power carbon mike, moving coil phone, pressel switch. New, 17/-.

RHEOSTAT—50 ohms. New. Boxed, 10/3. **RHEOSTAT**—44 ohms. New. Boxed, 9/-.

OK for Model Pathways. **105V. VARIABLE CONDENSERS**—30 pF, used, 1/6. 30 pF two gang, used, 2/- Both have short shafts. Post or Carriage Free. Mainland only. S.A.E. for List or Enquiries, please.

25, ASHFIELD PLACE, OTLEY, Yorks

FOR SALE

TELEVISIONS NEEDING ATTENTION, 9in.-10in. models, £4/10/- each. 12in. models £6/6/- each. 15in. models and Philips Projection models £11/10/- each; immediate despatch; carriage paid. **BARKERS**, 325, Brockley Road, S.E.4. (TD 6752.)

RECORDING TAPE, 1,200ft. P.V.C. 7in. reels. Leading makers cancelled export; listed 35/-, 22/6 only; guaranteed; p.p. 1/- **RADIOVISION**, 4, Praed St., W.2.

FIELD STRENGTH METERS, 50 micro amp. movement, T.S. 509 (U.S.A.); brand new, boxed; frequency 100/400 M/c. instructions, etc. £8. 302 Power Units, 230v., A.C. input, fully smoothed output; 700v., 120 M.A., 2 rectifier valves; brand new, but fuses on front may be damaged, 55/-, carriage paid; s.a.e. for list. **H. JAMES**, 175, Brettenham Road, Walthamstow, E.17.

100 APPROXIMATELY good second-hand 3/5 watt moving coil Loud Speakers with output transformers in individual wooden box baffles; price 11/- each, post and packing extra. **WHITETRADE LIMITED**, Maidstone Rd., Rochester. (Chatham 4638.)

NEON INDICATOR LAMPS, AM10E6, striking voltage 70/90, 10/- per dozen. Exposure Meter Photo-cells, 40 x 22mm., 7/6 each. **G. R. PRODUCTIONS**, 22, Runnymede Avenue, Bristol, 4.

CAR CIGARETTE LIGHTERS, 6 or 12 volt, 8/6, post free. **WHITSAW ELECTRICAL PRODUCTS**, 18, Woodrow Close, Greenford, Middlesex.

T/V TUBES

All Types and Sizes in Stock

First Class picture guaranteed, all sizes £6 each. With 6 months full guarantee. Terms C.W.O. or C.O.D. All orders dispatched within 3 days.

GRANTS

104, Church Road, Tranmere, Birkenhead.

GUARANTEED TELEVISION, 12in. 5-Channel models, first-class picture. £26 each, carriage paid. **THE GRAMOPHONE SHOP**, 19-21, Brockley Rise, London, S.E.23.

UNREPEATABLE OFFER—12in., 5 Channel T.V., £15; 14in., £22, good working order. **C. EDWARDS**, 1070, Harrow Rd., London, N.W.10. (Phone: LADbroke 1734.)

HI-FI TEST TAPE. Check your recorder with the B.R. Test Tape. Frequency response check, 50-10,000 cycles; transit and quality test 600ft. reel recorded at 7 1/2 or 3 1/2 in. per sec.; 20/-, post free. **BISPHAM RADIO LTD.**, 153, Red Bank Rd., Blackpool.

TAN IN 24 HOURS.—Super-ionic Sunray Lamps. Ultra-violet Infra-red combined; automatic exposure; controlled emission; all mains. Listed £7/10/-. Our price, 30/-, S.A.E. illustrated brochure. Dept. 100. **SCIENTIFIC PRODUCTS**, Cleveleys, Lancs.

New, Larger Catalogue from M. FOY.

VALVE CARTONS.—Miniatures, 10/6; "GTs," 12/-; "Gs," 14/- per 100 plus 2/- p. and p. Lists free. **RHS**, 155, Swan Arcade, Bradford, 1.

CABINETS
for
EQUIPMENT
SPEAKERS
PYE BLACK
BOX
RECORDS

Write for Catalogue

A. L. STAMFORD (Dept. L29), 20, College Parade, Salisbury Road, London, N.W.6

AMERICAN MAGAZINES. Year's subscription "Audio" 35/-, "High Fidelity" 50/-. Spec. copies 4/- & 5/- ea. Cat. free. **WILLEN LTD.** (Dept. 40), 9, Drapers Gdns., London, E.C.2.

TELEVISIONS, 9in. models £7/10/-, 12in. models £13/10/-, 12in. 5-channel models £19/10/- each; all working; carriage paid. Send for list. TOMLINS, 127, Brockley Rise, Forest Hill, S.E.23. (FOR 5497.)

SERVICE SHEETS

DO YOU EVER repair Radios and T.V.s? Then you require a Service Sheet. We have 1,000s and 1,000s of the actual ones used by the trade, for sale or hire; s.a.e. with enquiry. You also require our new, larger Catalogue, packed with exact replacement and servicing components, price 1/-. M. FOY, 6, Wykebeck Gardens, Leeds. 9.

ELECTRICAL

ASBESTOS RESISTANCE WIRE, 10, 30, 40, 65, 220 ohm. Per yard, 1/3, p.p. **SEMPLE**, The Mount, Heswall, Cheshire.

WANTED

VALVES WANTED, EY51, EY86, PCP80, PCC84, PCI83, U25, 10F1, 10C1, 10C2, 10P14, 5Z4G. Prompt cash; brand new only. R.H.S., 155, Swan Arcade, Bradford, 1.

WANTED, Transmitters BC191, Receivers BC312; Power Supply Units BD77; Transmitter/Receivers, types 1934, 1935 and 1936; Receivers, type 100; Teletype Equipment. R. GILFILLAN & CO. LTD., 7, High St., Worthing, Sussex. (Tel.: Worthing 30181.)

WANTED VALVES

All types for prompt cash. Must be new. State quantity.

WILLIAM CARVIS LTD.

103, North Street, Leeds, 7.

WANTED, Glass Dial for Ferguson Radio 204UX, 5 wavebands, medium and 4 short. Box No. 284, c/o PRACTICAL WIRELESS.

The "NEW WAVEMASTER"

Seven Transistor ALL Wave Superhet Portable with the Finest Performance of them All.

Negligible Running Costs; operates from 6v. Dry Battery. Absolutely no Aerial or Earth Required.

Fully tunable F.C. stage with efficient A.C.C. 3 I.F. stages, double wound, tapped, balanced and dotted I.F.T.s 470 K.C.s.

Push-pull output, negative feedback with 7" x 4" speaker. Easily assembled on prefabricated Paxolin chassis. Can be built for a total cost of £14 including cabinet.

All Components sold separately. Circuit and assembly data with component list 1/6.

TRANSISTORISED PUSH-PULL AMPLIFIER

200 M.w. for use with pick-up, mic. or as output for tuner, powered by 6v. dry battery.

Complete kit of parts, including prefabricated chassis, 4 transistors with new miniaturised components, etc. (less battery and speaker), 75/-.

Circuit with assembly data and component list 1/6.

Transistor transformers for the Mullard 200 M.w. circuit. Miniature interstage at 8/-, output at 7/6. Sub-miniature interstage 12 6. output 12/-.

Trade and Mail Order Lists.

OSMABET LTD.

14 Hillside Rd., Tottenham, London, N.15.

ALL TYPES of Valves required for cash. State quantity and condition. **RADIO FACILITIES LTD.**, 38, Chalcot Road, N.W.1. (PRImrose 9090.)

GLASGOW, Cameras bought for cash or taken part exchange for Tape Recorders, Players, or Amplifiers. **VICTOR MORRIS**, 406, Argyle St., Glasgow, C.2.

EDUCATIONAL

LEARN IT as you do it—we provide practical equipment combined with instruction in Radio, Television, Electricity, Mechanics, Chemistry, Photography, etc. Write for full details to E.M.I. INSTITUTES, Dept. PW47, London, W.4.

T/V and RADIO—A.M.Brit.I.R.E., City and Guilds, R.T.E.B. Cert., etc. on "no pass—no fee" terms. Over 95% successes. Details of exams. and home training courses in all branches of radio and T.V. write for 144-page handbook free. B.I.E.T. (Dept. 242G), 29, Wright's Lane, London, W.8.

THERE IS a national shortage of Mercantile Radio Officers. Why not make Communications your career? You can be assured of a sea-going appointment after qualifying at The School of Marine Radio and Radar (A.S.T.), Hamble, Southampton. For details, apply Commandant, quoting A.12.

CITY AND GUILDS (Electrical, etc.) on "no pass—no fee" terms. Over 95% successes. For full details of modern courses in all branches of Electrical Technology send for our 144-page handbook—free and post free. B.I.E.T. (Dept. 242A), 29, Wright's Lane, London, W.8.

ASTRAL RADIO PRODUCTS

HOME RADIO, 32-page illustrated booklet. Simple wiring instructions for Crystal Set, 1, 2, 3 Valves, 2-, post 3d. TRF COILS, Specified for Bed-side Push-button 4-, All Dry 3 Band, 3" Push-button 4-, etc., 6/6 pr., post 6d. Push-button Unit with modification data 7/-.

DIAL WAVE, HF coil, specified for Summer All Dry Portable, Modern 1 Valve, Modern 2 Valve, A.C. Double Triode 1-, etc., 4/3, post 3d.

IFT's Miniature, 1 x 11" x 21" in cans, Extra high Q, Special offer, 8/6 pr., post 6d.

K COILS, A.C. B' Bass 3-, 3/3 each, post 6d.

FRAME AERIALS, M.W., 5-, post 4d.

COIL PACKS, L.M.S., 36-, post 1/-.

Crystal Set Coils, L. & M.W., 2/6, post 3d.

82 Centurion Road, Brighton

H.A.C. SHORT-WAVE EQUIPMENT

Noted for over 18 years for S.W. Receivers and Kits of Quality.

Improved designs with Denco coils:
One-Valve Kit, Model "C" Price 25/-
Two " " " " " " " 50/-

All kits complete with all components, accessories and full instructions. Before ordering call and inspect a demonstration receiver, or send stamped, addressed envelope for descriptive catalogue.

"H.A.C." SHORT-WAVE PRODUCTS

(Dept. TH), 11, Old Bond Street, London, W.1.

WIRELESS—Day and Evening Class instruction for P.M.G. Certificate of Proficiency and Amateur Wireless Licence. Morse instruction only if required, also postal courses. Apply B.S.T., LTD., 179, Clapham Rd., London, S.W.9.

FREE! Brochure giving details of Home Study Training in Radio Television, and all branches of Electronics. Courses for the Hobby Enthusiast, or for those aiming at the A.M.Brit.I.R.E., City and Guilds, R.T.E.B., and other Professional examinations. Train with the college operated by Britain's largest Electronics organisation. Moderate fees. Write to E.M.I. INSTITUTES, Dept. PW28, London, W.4.

A.M.I.P.R.E.—For details of suitable study courses (only a limited number of students accepted) send for free Syllabus of Instructional Text. I.P.R.E. Conditions of Membership Booklet, 1/-. "The Practical Radio Engineer" Journal, sample copy, 2/3. 6,000 Alignment Peaks for Superhets, 6/-. All post free from SECRETARY, I.P.R.E., 20, Fairfield Rd., London, N.8.

A.M.I.Mech.E., A.M.Brit.I.R.E., City and Guilds, etc. on "no pass—no fee" terms; over 95% successes. For details of exams, and courses in all branches of engineering, building, etc., write for 144-page handbook, free. B.I.E.T. (Dept. 242B), 29, Wright's Lane, London, W.8.

WIRELESS. See the world as a Radio Officer in the Merchant Navy; short training period; low fees; scholarships, etc., available; Boarding and Day students. Stamp for prospectus. **WIRELESS COLLEGE**, Colwyn Bay.

SITUATIONS VACANT

THERE IS a national shortage of Mercantile Radio Officers. Why not make Communications your career? You can be assured of a sea-going appointment after qualifying at The School of Marine Radio and Radar (A.S.T.), Hamble, Southampton. For details, apply Commandant, quoting A.12.

COVENTRY RADIO

Component Specialists since 1925

We have now trebled the size of our premises in order to supply a larger range of Components, Amplifiers and Hi-Fi Equipment.

Send your enquiries to:

189-191 Dunstable Road,
Luton, Beds.

New Telephone No.:
LUTON 7388-9

SEE THESE FINE BARGAINS AT *The Walk-around Shop*

38 SET TRANSMITTER/RECEIVER

7.4 to 9 Mc/s. This Walkie Talkie is offered complete with throat microphone, headphones and collapsible aerial. Fully valved with 4 VP23 and 1 ATP4. Including leads and canvas carrying bag. **Brand New 65/-**, plus 5/- p. & p.

SMALL HEARING AID 3-VALVE AMPLIFIER

Containing crystal Microphone. 2-505AX, 1-507AX valves. This unit can be converted into a miniature receiver with aid of the following components:

Ferrite Rod, 5". 250 pF Trimmer Condenser, 1/6. 100 pF Condenser, 6d. 2-megohm Resistor, 4d. Balanced Armature Earphone, 3/6.

Voltage required is 30 to 45 volts H.T. and 1.5 volts L.T. Circuit and conversion diagrams sent free with each Amplifier. Price of Unit, less outer case, £1. Components for conversion, 10/6 extra, or sold separately.

SIGNAL GENERATOR AND WAVEMETER

Type W.1649. Frequency of signal generator: 140 to 240 Mc/s. Accuracy ± 0.5 Mc/s. Frequency of Heterodyne Wavemeter: 155 to 255 Mc/s. Accuracy ± 0.2 Mc/s. Containing VR135 and 4-VR91, 5 meg. crystal. Retractable aerial. Power requirements: 6.3 volts and 120 volts. Unit housed in copper lined wooden case. Size: 1 1/2 in. x 1 3/4 in. x 1 1/2 in. In good condition. £2.10.0, plus 10/- packing and carriage.

GYRO UNIT AND INVERTER

Inverter: 12 volt D.C. input, 3-phase 190 cycle output. (These inverters can be used successfully as 12 v. D.C. Motors for Models.)

Gyro Unit: Operates on 3-phase output from Inverter. Peak speed 11,400 r.p.m. Caged. Precision-made equipment. These units are ideal for experimenting and demonstration purposes. Size: Inverter, 4 in. x 3 in. x 3 in.; Gyro, 4 in. dia., including cage. Price 12/6 pair, plus 3/- p. and p.

No. 19 SET TRANSMITTER/RECEIVER

Covering 2 to 8 Mc/s. Fully valved and in As New condition. £35.0, plus 10/- p. & p.

RECEIVER UNIT Ex 1143A

10.72 Mc/s I.F.s. Frequency 100-120 Mc/s. suitable for conversion to 2 metres and Wrotham. Owing to a large purchase we can offer these units fully valved, with circuit diagram, at 25/- each, plus 3/- post-packing. Valve line-up: (4) EF50, (1) EL32, (2) EF39, (1) EBC33, (1) EA50.

Crystal Microphone Inserts. Suitable for connection directly into pick-up sockets of Radio or Gramophone Amplifier. No transformer required. Very sensitive. Guaranteed. 4/6 each, post paid.

MALLORY VIBRATOR PACKS 12 v., 150 v., 40 mA. Brand new and boxed, size 5 1/2 in. x 5 1/2 in. x 3 in., 12/6 each p. p.

Two 400 microamps Meter Movements. American Beam Approach Indicator containing two separate movements, one 200-0-200 microamps the other 400 microamps F.S.D. with shunt removed, two S.B.C. Neon Holders. New and boxed, 10/-, post paid.

Meters (Oil Temperature Indicator). 2 1/2 in. sq. Panel mounting. Basic movement 1 mA. or better. New and boxed, 5/- each, post paid.

HEAT TRANSFORMERS

6.3 volt, 1 1/2 amps., brand new, 6/6, plus 1/- p. p.

SMALL MAINS TRANSFORMERS

Input 230 v. 50 cycles. output 250 v., 40 mA., 6.3 v., 1.5 a. Size 3.9 in. x 2.4 in. x 2 in. Ideal for TV converters. Price 12/6 each, plus 1/- p. p.

CHARGER TRANSFORMERS

For 6 or 12 volt: 230 volt 50 cycles input. 9 and 17 volt 3 amp. output. Price 15/6 each, plus 1/- p. p.

PROOPS Bros. Ltd. Dept. P. 52, Tottenham Court Road, London, W.1. LANgham 0141.
Hours 9-6 p.m. Thursday to 1 p.m. Open all day Saturday

REPANCO

HIGH GAIN TRANSISTOR COMPONENTS

STANDARD RANGE

Ferrite Slab Aerial Type FS2. Designed for Long and Medium Wave reception with transistor portable superhet receivers. Slab size 5 1/2 in. x 7 in. x 5/32 in. Complete with fixing brackets, 13/6.
Combined Oscillator and 1st I.F. transformer Type OT1. 13/16 in. sq. x 1 1/2 in. I.F. Frequency 315 kc/s., 11/6.
2nd I.F. Transformer (315 Kc/s.), Type TT2, 5/-.
3rd I.F. Transformer (315 Kc/s.), Type TT3, 5/-.
I.F. Transformers enclosed in iron dust pots with slug tuning.
Push Pull Interstage Transformer Type TT4. Ratio 1 : 1 C.T. Stack size 1 1/2 in. x 1 1/16 in. x 7/16 in., 8/6.
Push Pull Output Transformer, Type TT5. Ratio 15 : 1 C.T. (Size as TT4.) Matched to 3 ohm speaker, 8/-.
MINIATURE RANGE.—For pocket receivers.

Ferrite Slab Aerial Type FS3. Medium Wave only. With fixing grommets. Size 3 in. x 7 in. x 5/32 in., 7/6.
Oscillator Coil Type XO8. Medium Wave only. Overall size 1 in. dia. x 1 in. Enclosed in Ferrite pots, 5/-.
I.F. Transformer Type XT6. Suitable for 1st and 2nd I.F. 455 Kc/s. Size 1 in. sq. x 1 1/16 in., 10/-.
I.F. Transformer Type XT7. Designed for 3rd I.F.T. or detector I.F.T. 455 Kc/s. Size as XT6, 10/-.
Push Pull Interstage Transformer Type TT9. Ratio 1 : 1 C.T. Radiometal Core. Size 7 in. x 7 in. x 13/32 in., 12/6.
Push Pull Output Transformer Type TT10. Ratio 8 : 1 C.T. Matched to 3 ohm speaker. Size as TT9, 12/6.

Practical and Theoretical circuits enclosed with each Repanco Transistor Component.
Send S.A.E. for complete list of Repanco Quality Components.

Mail Order and Trade:
RADIO EXPERIMENTAL PRODUCTS, LTD.,
33, Much Park St.,
COVENTRY
Tel.: 62572

Wholesale Enquiries and Export:
REPANCO, LTD.,
O'Brien's Buildings,
203-269, Foleshill Rd.,
COVENTRY
Tel.: 40594

radio upkeep and repairs

By Alfred T. Witts, A.M.I.E.E., etc.,
8th Edition. This practical handbook explains in an easy-to-follow style how to locate faults, how to remedy them and how to keep modern radio receiver apparatus in the best possible working condition. It forms a most valuable book for radio service engineers and mechanics, and for all who require a practical book of "do's and don'ts." 15/- net. "This little book is a god-send . . ."—Engineer.

PITMAN Parker St., Kingsway, London, WC2

Wanted!

QUALIFIED MEN AND WOMEN

Industry & Commerce offer their best posts to those with the necessary qualifications—such posts that will bring personal satisfaction, happiness, good money and security. As part of a modern industrial organisation, we have skilled knowledge of what is required in industry to-day and the best means of training personnel for its present day and future requirements. We specialise also in teaching for hobbies, new interests or part-time occupations in any of the subjects listed below. Make your own choice and write to us to-day for further information. There is no obligation of any kind.

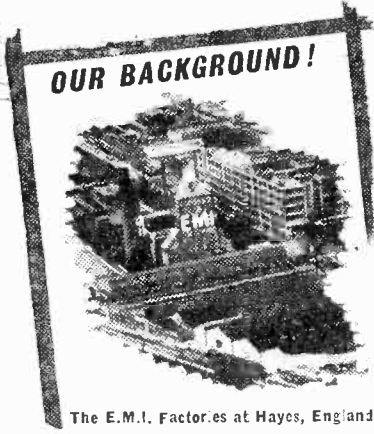

OUR BACKGROUND!

The E.M.I. Factories at Hayes, England.

The only Home Study College operated by a world-wide manufacturing organisation

EMI INSTITUTES

PERSONAL & INDIVIDUAL TRAINING IN—

- | | | | |
|---------------------------------------|----------------------------|------------------------------------|----------------------------------|
| Accountancy | Customs Officer | Languages | Refrigeration |
| Advertising | Draughtsmanship | Management | Sales Management |
| Aeronautical Eng. | Economics | Maintenance Eng. | Sanitary |
| A.R.B. Licences | Electrical Eng. | Mathematics | Engineering |
| Art (Fashion, Illustrating, Humorous) | Electrical Installations | M.C.A. Licences | Salesmanship |
| Automobile Eng. | Electronics | Mechanical Eng. | Secretaryship |
| Banking | Electronic Draughtsmanship | Metallurgy | Shorthand & Typing |
| Book-keeping | Eng. Drawing | Motor Eng. | Short Story Writing |
| Building | Export | Painting & Decorating | Short Wave Radio |
| Business Management | Heating & Ventilation Eng. | Photography | Sound Recording & Reproduction |
| Carpentry | High Speed Oil Engines | P.M.G. Certs. | Telecommunications |
| Chemistry | Industrial Admin. | Police Production Eng. | Television Time & Motion Study |
| City & Guilds Exams | Jig & Tool Design | Production Planning | Tracing |
| Civil Service Commercial Subjects | Journalism | Radar Radio Amateurs (C&G) Licence | Welding Workshop Practice |
| Commercial Art & Drawing | | Radio & Television Servicing | Works Management and many others |

Also courses for GENERAL CERTIFICATE OF EDUCATION, A.M.I.H.&V.E., A.M.S.E., A.M.Brit.I.R.E., A.M.I.Mech.E., A.M.I.E.D., A.M.I.M.I., A.F.R.Ae.S., A.M.I.P.E., A.M.I.I.A., A.C.C.A., A.C.I.S., A.C.C.S., A.C.W.A., City & Guilds Examinations, R.T.E.B. Serv. Cert., R.S.A. Certificates, etc.

NEW! Courses with PRACTICAL EQUIPMENT

in RADIO · TELEVISION · MECHANICS CHEMISTRY · ELECTRICITY DRAUGHTSMANSHIP · PHOTOGRAPHY (tc., etc.)

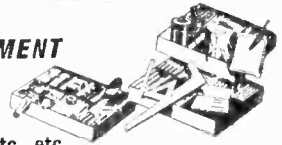

COURSES FROM 15/- PER MONTH

POST THIS TODAY

FREE

E.M.I. INSTITUTES, Dept. 32K, London, W.7

NAME _____ AGE _____ (if under 21)

ADDRESS _____

Subject(s) with/without equipment _____

BLOCK CAPS PLEASE

DEC. 57 We shall not worry you with personal visits

IC 92

-Part of "His Master's Voice", Marconiphone, etc. etc.

Trace the Trouble
in a Trice



PIFCO

ALL-IN-ONE
RADIOMETER

- ★ Circuit Test
- ★ L.T. & H.T. Tests
- ★ mA Test
- ★ Valve Test

Use the PIFCO All-in-One RADIOMETER for the practical testing of all types of radio and electrical apparatus. You can carry out continuity and resistance tests, check H.T., L.T., and G.B. voltages, also Household Appliances, Car Lighting Systems, Bell Circuits, etc. May be used on A.C. or D.C. mains.

Obtainable from your local dealers.
Write for informative folder to:—

★ ONLY
32/6
COMPLETE

PIFCO LTD., WATLING ST., MANCHESTER, 4
36-37, UPPER THAMES ST., LONDON, E.C.4

AT LAST, A REALLY PORTABLE
POCKET LOUDSPEAKER SET

The famous Teletron "Companion" is a receiver of unique design and extreme portability. Contained in a neat plastic case, measuring 4 1/2 x 3 x 1 1/2 inches approximately, it gives loudspeaker reception on long and medium wavebands, and requires no aerial or earth. Using three transistors, the total power supply is obtained from three tiny 1 1/2 volt penlight cells. Complete Kit of Parts, 89/6, postage 1/6 extra. Or send four 1d. stamps for Illustrated Folder and Circuit Diagram. This offer applies only to Great Britain and Northern Ireland.

CENTRAL RADIO SALES
CENTRAL CHAMBERS, 11 SMALL ST.
BRISTOL, 1

NEW CATALOGUE
"60 Pages of Spares"
Price 1/- Post Free.

It includes 118 exact replacement Potentiometers and Mains Droppers, Line Output Transformers, Tools, Servicing Aids, Etc., Etc. For example.

MAINS DROPPERS. For Ultra Twin—SMD.6, 1,690 ohms, 1,450 ohms, 5/3; SMD.7, 175 ohms, 340 ohms, 410 ohms, 5/3, Etc., Etc.

OUTPUT TRANSFORMERS. For Ultra Twin, 11/9. Philips 290 U., 12/9. Etc., Etc.

ELSTONE TRANSFORMER RANGE. CRT Isolation, Mains Primary, 2 v., 4 v., 6.3 v., 10.8 v., 13.3 v., optional 20 per cent. boost, 22/- State CRT voltage required. Etc., Etc.

Minimum Postage 6d.

M. FOY
6, Wykebeck Gardens, Leeds, 9.

The "TYANA"
Standard Soldering Iron



- Adjustable Bit.
- Weight approx. 4 oz.
- Heating Time 3 min.
- 40 Watt economy Consumption.
- Standard Voltage Ranges. 16/9

Replacement Elements and Bits
always available.

"DIPLOMA" HEADPHONES



Lightweight
High Resistance (4,000 ohms). Complete with cord. 17/6

Ideal for CRYSTAL SETS and also for use with TAPE RECORDERS.

KENROY LIMITED
152/297 UPPER ST., ISLINGTON,
LONDON, N.1.

Telephone: Canonbury 4905-4663

Forrest

Transistor Transformers for
Quality Equipment

H. W. FORREST (Transformers) Ltd.
349, Haslucks Green Road, Shirley,
Solihull, Warwicks. Tel.: Shirley 2483.

TELEVISION

The advance of Radio Technique will offer unlimited opportunities of high pay and secure posts for those Radio Engineers who have had the foresight to become technically qualified. How you can do this quickly and easily in your spare time is fully explained in our unique handbook.

Full details are given of A.M.Brit.I.R.E., City & Guilds Exams., and particulars of up-to-date courses in Wireless Engineering, Radio Servicing, Short Waves, Television, Mathematics, etc., etc. We guarantee "NO PASS—NO FEE." Prepare for to-morrow's opportunities and future competition by sending for this very informative 144-page guide NOW—FREE and without obligation.

**BRITISH INSTITUTE OF
ENGINEERING TECHNOLOGY**
(Dept. 242), COLLEGE HOUSE,
29-31, Aright's Lane, Kensington, W.8

AMAZING OPPORTUNITY



to install your own I.T.V. 3 and 5 element folded dipole array for loft or gutter board mounting, especially made to our own specification by well known manufacturer.

State channel when ordering.
21- & 32 6. Postage and Packing 2-. 75Ω coaxial cable 8d. yd.

Also, BBC/ITA "Panorama" room aerial, complete with vert. your set to a transportable. 12/9. Postage and packing 1/-.
Trade enquiries invited.

K.V.A. ELECTRONICS
159, Kent House Road, Beckenham,
Kent. SYD 2488.

SPARKS' DATA SHEETS presents

THE "331"
A.C. SHORT WAVE
4-VALVE T.R.F. RX.

"Cathode-coupled" Regeneration ensures amazing Sensitivity and Selectivity plus 100% Stability. 10 to 220 M. Switched Coils, Separate Power Pack. Data Sheet (27" x 22", showing every detail in simplified form. Plus full Instructions, etc. 3/6 Post Free.

THE "COX'N"
A.C. D.C. 3-VALVE

A New design offering New Thrills and Interest. 60 to 220 Metres covering Ship-to-Shore, Aeronautical Bands. 80/100 Amateurs, Trawlers and Int. Call and Distress Bands, Etc., Etc. Data Sheet. Etc. 3/3 P.P.

L. ORMOND SPARKS (P)
Valley Road, Corfe Castle, Dorset.

Fidelia HAND BUILT

Fidelia genuine hand built real high fidelity equipment for those people who desire the finest.
Major AM/FM 12 valves, £44.
De-Luxe AM/FM 11 valves, £34/10/0.
Imperial, high fidelity amplifier and VHF tuner, £34.
Full details willingly but 6d. in stamps is appreciated.

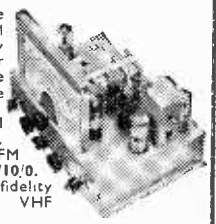

ELECTRO ACOUSTIC DEVELOPMENTS
2, Amhurst Road, Telscombe Cliffs, Sussex.

EXPRESS ELECTRONICS

11 MEADWAY, WARLINGHAM, SURREY.

THE SPOT THE SPOT

G3EKX DERBY

TERMS: C.W.O. TEL: 41361

VALVES NEW, TESTED AND GUARANTEED

1AC6	8/6	6BR7	10/6	12AU7	6/9	ECC81	8/6	N18	7/6
1C1	7/6	6BV6	7/6	12AX7	8/6	ECC82	6/9	N19	7/6
1C2	8/6	6BW7	8/-	12K7GT	8/-	ECC83	8/6	PCCR4	9/-
1C3	9/-	6CH6	7/-	12K8GT	10/6	ECC84	10/6	PCF80	10/6
1F1	8/6	6C10	9/-	12Q7GT	8/-	ECC80	10/6	PCF82	10/6
1F3	7/6	6D1	1/6	35L6GT	8/6	ECC82	10/6	PL81	11/6
1FD1	8/6	6D2	6/9	35W4	8/6	ECH42	10/-	PY81	8/-
1FD9	7/6	6F12	6/-	35Z4GT	8/-	ECH81	8/6	PZ30	17/6
1P1	9/-	6F15	9/-	5763	10/6	ECC80	8/6	U52	8/6
1P10	7/6	6I5G	5/6	D77	6/9	EF37A	9/-	U76	8/-
1P11	7/6	6K7G	5/6	DAF91	7/6	EF39	5/-	U78	7/-
1R5	7/6	6K8GT	9/6	DF91	7/6	EF41	9/-	UBC41	8/6
1T4	7/6	6L6G	10/6	DF95	8/6	EF80	8/6	UCH42	8/6
1S5	7/6	6Q7GT	9/-	DH76	8/-	EF91	6/-	UF41	8/6
1U5	7/6	6SA7	8/-	DH77	7/6	EF92	5/6	UL41	8/6
3Q4	7/6	6SL7GT	7/6	DH142	8/6	EL37	19/6	UY41	7/6
3S4	7/6	6SN7GT	8/-	DH150	10/-	EL38	20/-	W76	8/-
3V4	7/6	6V6G	7/6	DK91	7/6	EL41	10/-	W77	5/6
5U4G	8/6	6V6GT	7/6	DK92	8/6	EY51	9/6	W142	8/6
5Y4G	7/-	6X4	7/-	DK96	9/-	EZ35	6/6	X17	7/6
5Z4G	9/6	6X5GT	6/6	EAS0	1/6	EZ40	8/-	X18	8/6
6AL5	6/9	757	8/6	EABC80	8/6	EZ80	8/-	X142	8/6
6AM6	6/-	8D3	6/-	EB91	6/9	EZ33C	9/-	X150	10/6
6AT6	7/6	12A8H	10/6	EBC41	10/-	KT33C	11/-	Z77	6/-
6BA6	7/6	12AT6	8/6	EBF80	9/6	KT66	7/6	ZD17	7/6
6BE6	8/-	12AT7	8/6	ECC35	7/6	N17			

Please Send Extra for Carriage, etc. S.A.E. for Lists
ALLOY TUBING.—3/8" O.D. 8d. per foot. 1/7, 1/4, 1/2, 3/4, 1, 1.5, 14 foot 2" O.D. masts. 52/6. We stock nearly every part to make any amateur aerial. And we send tubing, etc. to any part of the country. Any size or quantity.

EDDYSTONE RECEIVERS AND COMPONENTS now stocked. Full vision V.F.O. dials. 24/6. Replacement parts for your old 600. Part exchanges. Eddystone catalogue and price list (send large S.A.E.) on request.

REPANCO TRANSVEX.—Booklets. 1/6. All components in stock. Suitable transistors. Yellow and green. 10/- Yellow and red spot. 21/-. Both in printed packets and characteristics given inside, definitely superior job. All 7 oiled at £4 with germanium diode. Post free.

TELETRON COMPANION POCKET TRANSISTOR. Booklet. 6d. Ferrite rods. 15/-. Ardent transformers. 10/- ea. Cabinet, chassis, speaker grill. 8/6, etc., etc.

GELOSO RX 207, £83 valved. TX 65GNS less valves, V.F.O.'s and calibrated dials. £72/6. Geloso mikes, floor stand, 6 mns. Table stand, 41 mns. Inserts. 30/-

BRITISH HEAD & BREAST SETS, 16/-, in case, 2/- postage. AR77.—£30. SX28. £35 (both with manuals).

BLACK & DECKER.—1" drills, £5.19/6. 5" saw attachment £3.11/6. Polishers, lathe, etc., etc. All by return. Please add carriage.

TRUVOX.—Mk. 4. Deck. £27/6-. Amplifier type C. £17/17/- in stock. 10" carr. and ins.

ASPEN TAPE DECK KITS, £9/5-. plus 5/- carriage. New improved model. Matching amplifier kit, £5/18/-. less valves. Power supply kit, £2/18/6. Carriage extra.

JASON F.M. KITS.—Argonaut. Tunable and switched models, all in stock. Send 2/6 P.O. for booklet. Parts can be supplied separate.

Please send us your requirements. We will always send goods by return whenever possible. Give us a call when in town. Just ask for 'The Spot'. We are next to Lloyds Bank.

NORMAN BIRKETT LTD., THE SPOT, DERBY

MATCHED PAIRS

KT66 27/6. 6V6G and GT 17/-, 6BV6 18/- per pair.

SETS OF VALVES

DK91, DF91, DAF91, DL92 or DL94.....	27/6
IR5, IT4, IS5, 354 or 3V4.....	27/6
6K8, 6K7, 6Q7, 6V6, 5Z4G.....	35/-
12K8, 12K7, 12Q7, 35L6, 35Z4.....	35/-

Postage and packing, 6d. Over £1 post free. C.O.D. 2/6.

W. B. SUPPLIES

MAIL ORDER DEPT.
 22 SWAN STREET
 MANCHESTER 4

TERMS.—Cash with order. Orders under 20/- add 3d. postage. Over 20/- add 1/3.
TRANSISTORS—Red Spot. 6/6; White Spot, 15/-; Repanco 3D Kit of Parts less speaker. 67/-; Plans, 8d.; Balanced Armature. 2p. pieces, ideal transistor speakers, only 3/-.
2IN. TUBES VCR139A, 17/6; Valves EF50, 3/3; VR65, 2/-; VR92, 9d.; Neon Screwdrivers 110v. to 380v., 3/6; Droppers for Car Radio 12 v. to 6 v., 5/-.
T.V. RECTIFIERS 250 v. 300 Mcs (4A116), 15/-.
BOOK ON "HOW TO MAKE AERIALS FOR B.C., I.T.V. AND V.H.F." only 2/10 post paid.
MORSE TAPPERS, 2/-.
CONVERTER TRANSFORMERS Primary 230 v., Secondary 250 v. 40 Mcs., 6.3 v. 1.5 amps. 13/6.
CONTROL BOX with 2-24 volt dimmers and on-off switch. 2/9.
T.V. CIRCUITS & SERVICE DATA book covering Ferranti T1215, T1415, G.E.C. BT247 C, 514 C, 4541 C, Pye P.V1, F.V1C, Regentone T15 Mark 2, L. BH. "B1912" L. B & H. The whole lot. 3/10, post paid.
TRANSFORMERS EX W.D. Primary 200-240 v., Secondary 350-0-350 v. 160 Mcs 1,000 v. 10 Mcs. 4 v. 3 a, 4 v. 3 a, 2 v. 0-2 v. 3 a, with smoothing choke to match, 18/6.
AMPLIFIERS FOR B.K.O.R.D. CHANGERS, 3 watts output, 2 valves, brand new in makers' cartons, with instructions. A real bargain at 70/-.
COAXIAL CABLE, new stock from makers, 50 yds. drum, 25/-, Resistor colour code chart, simplest ever invented, 1/6.
ALL COMPONENTS for Repanco 3D Transistor Set in stock, sold separately at list prices. Immediate delivery on all items.

COPPER WIRE

ENAMELLED, TINNED, LITZ, COTTON AND SILK COVERED. RESISTANCE WIRES, 1 oz., 2 oz. & 4 oz. REELS. All gauges available.
 B.A. SCREWS, NUTS, WASHERS, soldering tags, eyelets and rivets. EBONITE AND BAKELITE PANELS. TUFNOL ROD, PAXOLIN TYPE COIL FORMERS AND TUBES. ALL DIAMETERS.
 Latest Radio Publications. SEND STAMP FOR LISTS.

SPECIAL OFFER

G.E.C., B.T.H. & WESTINGHOUSE GERMANIUM CRYSTAL DIODES
 1/- each. Postage 3d.

Diagrams and three Crystal Set Circuits Free with each diode.
 A large purchase of these fully GUARANTEED diodes from the manufacturers enables us to make this attractive offer.

CRYSTAL SET INCORPORATING THE SILICON CRYSTAL VALVE

Adjustable Iron Cored Coil. RECEPTION GUARANTEED
 Polished wood cabinet, 15/-, post 1/6
 A REAL CRYSTAL SET, NOT A TOY

POST RADIO SUPPLIES

33 Bourne Gardens, London, E.4

LYONS RADIO LTD.

Dept. M.P., 3 GOLDHAWK ROAD, SHEPHERDS BUSH, LONDON, W.12
 Telephone: SHEpherds Bush 1729

BATTERY CHARGER COMPONENTS.

Full wave, bridge type, Selenium Rectifier for charging up to 12v. at 4A. PRICE 16/6, post 1/6. Charger Transformer: Pri. 200/250v. 50 cps. and Sec. tapped 3.5v., 9v.1 and 17v. for use with above rectifier for providing an output of 2v., 5v. or 12v. at 4A. Price 17/6, post 1/6.
 SPECIAL PRICE both items together, 32/6, post 2/6.
 0 500 MICRO-AMMETERS. M/c. type 21ms. dia. New batch just received enables us to re-offer these fine meters for ONLY 17/6, post 1/6.
INDICATOR UNITS TYPE 233. Contain stacks of useful components and cathode ray tube type VCR97 and 11 valves (2-VR92, 3-VR54, 1-VR116, 2-VR65, 3-VR91). In used but good condition. PRICE ONLY 55/-, or less valves but with C.R.T. PRICE ONLY 30/-, carriage 8/6.
MINIATURE POTENTIOMETERS. Approx. 1in. dia. spindle x 1in. dia. 1in. long. Values —5, 20, 250, 500, 1K, 10K, 200K ohms. Sample 2/6, 3 for 6/-, 6 for 9/-, 12 for 15/-, post free
L.T. TRANSFORMERS. For model makers and experimenters. Primary 200/250 v. 50 cps. Secondary 30v. at 2A, tapped at 3, 4, 5, 6, 8, 9, 10, 12, 15, 18, 20 and 24v. Brand new and guaranteed. All connections clearly marked. PRICE 21/-, post 1/9.
THROAT MICROPHONES. American made, carbon type with neck band. As new in maker's cartons. PRICE 2/8, post 1/2-

AUDIO OSCILLATOR UNIT TYPE 2

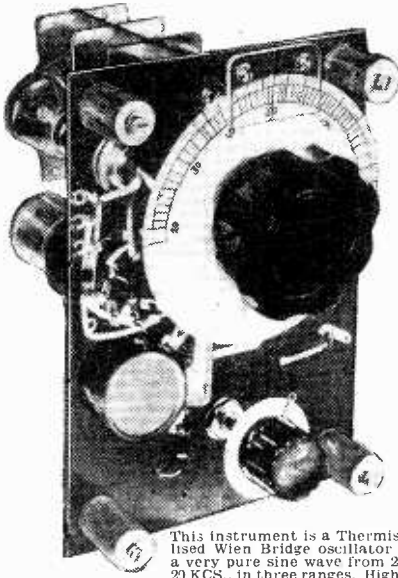

This instrument is a Thermistor stabilised Wien Bridge oscillator providing a very pure sine wave from 20 c.p.s. to 20 KCS. In three ranges. High accuracy in this an exceptionally useful instrument for the testing of high-fidelity equipment. Send stamp for full details.

PRICE £7.10.0 plus 5/- P. & P.

HOMELAB INSTRUMENTS LTD., 619, HIGH ROAD, LEYTON, E.10. Telephone: LEYtonstone 8851.

Best Buy at Britain's

No. 19. Mk. 2 WIRELESS SETS. Two Transmitter-Receiver and Intercom. Amp. combined. For voice or Morse. Tuning 2 to 8 Mc s., and 235 Mc s. fixed freq. Complete with 15 valves, 500 micro-Amp. meter, instruction booklet, and circuit. Made in U.S.A. Brand new. Tested. 85/-, Carr. 10/-. Send S.A.E. for full details. **THRO COMBINATION RECEIVERS**, 50 Kc's to 30 Mc's. 40 COMBINATION RECEIVERS. Send S.A.E. for full details. **POCKET VOLTMETERS**, 0-25 and 0-250 v. D.C., 2 1/2 in. diameter. Complete with leads and rexine case. Brand new. Tested. 12/6. **SPEAKERS**, 3 Ohms, 6 1/2 in. diam. In grey wrinkled steel cabinet 9 x 9 x 5 1/2 in. Complete with volume control, and transformer for 600 Ohms line. Brand new. 27/6, post 3/6. **TUNING DRIVES**, Modernise your R1155 with this latest drive as fitted to the model "N". Complete. Easily fitted. 12/6. **VIBRATOR PACKS**, Input 6 v. D.C. Output approx. 100 v. at 20 m.amps. D.C. fully smoothed and R.F. filtered. Size 6 1/2 in. x 5 1/2 in. x 2 1/2 in. Fitted with Mallory 629C Vibrator. BRAND NEW. 12/6. **VIBRATOR PACKS**, Input 6 v. D.C. Output 230 v. D.C. 100 m.amps., fully smoothed and R.F. filtered. Complete with OZ4 and vibrator. Brand new. 25/-.

RCA OUTPUT TRANSFORMERS, Pri. push-pull 6L6's. Sec. 600 ohms, tapped at 15, 7.5 and 5 ohms. Tertiary winding for negative feedback. Handles 20 watt. Pot. Fed. Circuit of RCA amplifier supplied FREE. Brand new. 27/6.

MAINS TRANSFORMERS, Input 200 to 250 v. 50 c/s. Outputs 275-0-275 v. 100 mA.; 6.3 v. 7 (Govt. ratings), 4 x 1 1/2 x 4 in. high. Upright Mtr. Brand new. 32/6, postage 2/6. **MAINS DIMMERS**, 300 ohms, 300 watts, 1 amp. BERCO. Brand new. 15/-, post 1/6. **JACK BONES**, 9 miniature insulated. Igranite jack sockets, fitted in metal box 3 x 3 x 6 1/2 in. Brand new. SNIP 12/6, postage 1/6. **TWO-WAY MORSE TRAINING SETS**, W/T Mk. 3. Consists of two valve oscillators (ARPI2's) (one with pitch control), for one or two operators. Has provision for creating "Atmospherics." In polished oak case, 12 1/2 in. x 10 in. x 8 in., wt. 16 lbs. Complete with valves, leads, 2 keys, 7-way terminal board, circuit and instructions butless batteries and phones. Ideal for Cadets, Scouts, etc. SNIP 19/6, plus 7/6 carriage. Headphones for above, 10/6 pair. **AVO MINOR LEATHER CASES**, New, with strap, 7/6. **CAR AMMETERS**, 30-0-30 amps., 5/-.

PLEASE ADD POSTAGE OR CARRIAGE ON ALL ITEMS
CHARLES BRITAIN (RADIO) LTD.
11 Upper Saint Martin's Lane, London, W.C.2
TEmple Bar 0545
Shop hours 9-6 p.m. (9-1 p.m. Thursday). Open All Day Saturday

Solder with
PERMATIP
AND
PERMABIT
INSTRUMENTS
FOR
GREATER
SOLDERING
EFFICIENCY

The soldering bit which maintains its face indefinitely without attention. 25 models available for mains or low voltage supply. Bit sizes 3/32 to 3/8 inch. Full details in booklet S.P.10 from sole manufacturers:-

LIGHT SOLDERING DEVELOPMENTS LTD.,
106, GEORGE STREET, CROYDON, SURREY. Tel. CR07don 8589.

Morse Code operating . . . as a PROFESSION

45 years of teaching Morse Code is proof of the efficiency of the Candler system. Send 3d. stamp for Payment Plans and Full Details of all Courses.

CANDLER SYSTEM CO. Dept. 510 52b, Abingdon Road, London, W.8. Candler System Co., Denver, Colorado, U.S.A.

TRANSISTOR SUPPLIES

TRANSISTORS, I.F., 7/6; R.F., 13/6; Mullard OC1, 24/-; OC72, 30/-; Matched pairs OC72, 83. Diodes, 1/6. Mullard, 5/-; Brimar, 7/6. **MORCO TRANSISTOR and Diode Coil** for transistor and diode circuits. **3-TRANSISTOR TRANSFORMERS**, Interstage, 8/6; Driver Push-Pull, 8/6; Push-Pull output, 9/6. **ELEKTROLYTICS** for transistor circuits, 8 uF, 2-; 15 uF, 2-; 50 uF, 1/6. **TELETRON COMPANION PARIS, 87/-**. All items at Manufacturers' Prices. **FERRITE ROD ASSEMBLY**, Long, medium wave and coupling coil for MORCO CIRCUIT, 13/6. **L.D. 10 SPEAKER**, sensitive P.M., 5 in., 18/6; output transformer for same, 5/-. **SINGLE EARPIECE**, moving coil—used as MINITRANS SPEAKER, 5/-; Transformer to Match, 2/6; Volume Control 5K, 2/9; TAPP, 9d. Carbon Power Hand Mic, 5/-; Jacks and Plugs, 2/-; Connecting Wire, 3d. foot. 4) volt battery, 1/-. **BONES**, 2/6, 5/-. Rexine to cover same, 1/3, 2/6, 3/6. Knobs, 9d., 1/-, 1/3. Chokes—Special for Morco Circuit, 3/-; Aerial wire, 6d.; 4/-; 75t, 6/-; Insulators, 6d. Multicores solder, 2/6. Solon S. Iron, 24/- (state voltage). Terms: C.W.O. postage extra. Excess refunded. Send 6d. stamps for transistor circuits and list.

MORCO EXPERIMENTAL SUPPLIES (Props.) - Moores (Sheffield), Ltd., 8 & 10, GRANVILLE ST., SHEFFIELD, 2. Tel.: 27461

RECORD PLAYERS
GRAM MOTORS AUTOCHANGERS CABINET.

COLLARO AC 3 554, Three-speed, single player for A.C., plus 200-250 v., cream finish, complete with turnover crystal pick-up, "T" type head. Strictly limited quantity at £6.19.6, plus 5/6 carr. **CRYSTAL PICK-UPS** fitted Acos HG157 cartridge. Ultra lightweight. Our price 37/6, plus 2/6 carr. **3-SPEED RECORD PLAYERS**, fitted with Acos turnover HG157 pick-ups with twin sapphire styl, rexine case with lid, fitted clasp and handle. Worth 10 gu., our price 27/5.6, plus 5/6 carr. **4-SPEED GRAM MOTORS**, complete with crystal Pick-ups. Our Price 99/6, plus 3/6 carriage. **REXINE COVERED CABINETS**, single player size, suitable most auto-tune units, including transcription motors. (Motor board incut.) Our price 48/6, plus 5/6 carriage. **PORTABLE RECORD PLAYER CABINETS** to house Diamond, Collins, Gram and 20 Grams, with space for Amplifier and Speaker. Rexine finish in attractive colours, fitted catches and handles. Our price 23.5.0, plus 5/6 carriage.

Send stamp for complete bargain lists.
RONALD WILSON & CO. (DEPT. P.W.), 12 BRIDGE STREET, WORCESTER.

RADIO AND TELEVISION COMPONENTS

All parts in stock for:
Viewmaster, Soundmaster, Telexing, etc.
Easy Terms available.
24d. stamp (only) for Catalogue.

JAMES H. MARTIN & CO.
FINSTHWAITHE, NEWRY BRIDGE, ULVERSTON, LANCs.

RADIO VALVE SUPPLY
GLAZEBURY, NR. MANCHESTER

VALVES GUARANTEED

EF90	7/6	EL91	3/6	12A77	8/-	35Z4	6/6
ECL80	9/-	EF92	5/-	12SL7	5/-	EB31	2/-
EZ80	8/-	5Y3	7/-	6SN7	6/6	1V870	4/-
RY51	9/6	5Z4	7/6	6AC7	5/6	R10	4/-
EF91	8/-	12AU7	7/6	6F6	6/6	6C7	6/-
EF50	3/6	12AX7	8/-	6V6C	6/6	6C1	6/-

Postage 6d.

DO IT AT HOME

It is so easy with the
RODING HOME CONSTRUCTOR'S HANDBOOK

Our latest issue is beautifully printed with a full colour cover. Packed with technical data, set building and servicing hints, facts and formulae, resistance colour code, soldering hints, descriptions, full parts lists and circuits of modern receivers, tape recorder, feeder unit, communications set, etc. Send 2/6 (plus 5d. post & p.). "Easy-as-A.B.C." FULL SIZE construction sheets for any of these units are available FREE with orders enabling even the beginner to get professional results first time! This claim is confirmed by hundreds of genuine un-solicited testimonials received.

NEVER BEFORE HAS THERE BEEN A BOOK SO VALUABLE TO NOVICE AND EXPERT ALIKE!

RODING LABORATORIES
 Hurn Airport, Christchurch, Hants

TECHNICAL TRADING CO.

13 CHANNEL CONVERTERS. Famous make complete PCC84, PCC80, Beauf. Cabnet. All instructions, all coils, £3.15.0.
 GERMANIALUMETAL DIODES. Guaranteed, 9d. ea., 8 - doz. (R100 - B28) RECEIVERS. Overhauled, tested, £19.

TRANSISTORS! RED SPOT (Up to 800 k.c.s.) ... 7/-
 GUARANTEED
TRANSISTORS! WHITE SPOT (Up to 2.5 Mc.s.) ... 14/-
 GUARANTEED

POWER PACKS, 230 v. A.C., two separate outputs, each 375, 550 or 820 v., 200 250 ma. double smoothed. Also 6.3 v. 5 a. Top quality, sealed cases, less valves, 28, with four 5U4G, £7. 12 v. 4 amp. Bridge Rects., 9/6

VALVE VALVES AS ADVERTISED PREVIOUSLY AVAILABLE
 EG524C, 9 - 88N7GT 5/9, EF50 2/6, EF91 7 - , etc.
 FOR FULL VALVE LIST AND CLEARANCE BARGAIN DETAILS
 SEND SAE FOR SPECIAL LIST.

Package 1 - in £1 (1/9 in £1 Speakers Trans.) Min. 6d. No C.O.D. 10,000 OTHER BARGAINS TO CALLERS AT ---
350,352 FRATTON ROAD, PORTSMOUTH

THE HATFIELD BIAS OSCILLATOR COIL

is still the only one (including Push-Pull oscillators) which is sold with a guarantee, backed by an N.P.L. report, of less than 0.28 of 1 per cent. distortion." Coil, with full instructions, 10/6 post free. BIAS REJECTOR COILS, 5/6, post free or 15/6 the pair.

Sorry about the delay with the new Motek K9 decks, but these are now available at 21 gns. or, with pre-amplifier built on, and ready to use with your own Amplifier, 26 gns. Power Pack, 3 gns. extra. The K9 deck has an unequalled specification, including 3 speeds, 7 1/2, 3 1/4 and 1 1/2 ins. per sec. 3 motors, fast forward and rewind, "pause," digital counter, adjustable azimuth, fully automatic operation and utter reliability.

The VIKING TAPE RECORDER incorporates all the above and is sold complete at 44 gns. Send for details. Trade inquiries welcomed.

USUAL HIRE PURCHASE & CREDIT TERMS AVAILABLE.

HATFIELD RADIO

78 Stroud Green Rd., London N4

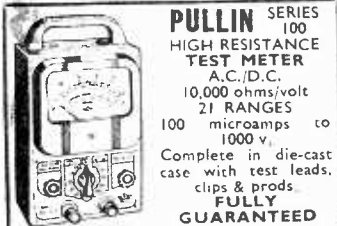

PULLIN SERIES 100
 HIGH RESISTANCE
 TEST METER
 A.C./D.C.
 10,000 ohms/volt
 21 RANGES
 100 microamps to
 1000 v.
 Complete in die-cast
 case with test leads,
 clips & prods.
**FULLY
 GUARANTEED**

CASH PRICE or Deposit £2-10-0 & nine further monthly payments of £1-4-6.
£12-7-6

Illustrated brochure free on request
FRITH RADIOWARE LTD
 69-71 CHURCH GATE LEICESTER
 & 28 HIGH ST NEWPORT PAGNELL Bucks

GRAM-PAK AMPLIFIERS

Complete £3.19.6 P & P 2/6

This excellent 4-watt amplifier fits neatly into any record player leaving ample room for speaker. Suitable with any speaker and all modern crystal 3-speed pick-ups. Dimensions 7" x 2 1/2" x 1 1/2". Pressed steel plated chassis. Perfect, distortionless quality guaranteed. For 200-250 v. A.C.
 ACCESSORIES:
 ACOS crystal to-mover pickup, £1.14.6.
 7" x 4" elliptical speakers, 19s. 6d.
 BER 3-speed player unit with above pickup, 24s. 12s. 6d.

THE COMPLETE OUTFIT READY FOR YOUR CABINET 29.10.0. post free.
 6d. stamp brings details by return.

ELECTRO-ACOUSTIC LABS.
 ACADEMY STREET, INVERNESS

FM and HI-FI Components

- | | |
|---------------------------|---------|
| DENCO F.M. TUNER circuits | 1s. 6d. |
| RADIO CONST'R. F.M. | 2s. 0d. |
| MULLARD AMPLIFIERS | 3s. 6d. |
| G.E.C. 912 PLUS AMPLIFIER | 4s. 0d. |
| G.E.C. F.M. PLUS TUNER | 2s. 6d. |
- Separate price lists available on request to
J. T. FILMER 82, DARTFORD RD., DARTFORD, KENT.
 Tel. Dartford 4057.

A really small RADIO RECEIVER

This radio receiver, although small enough to fit inside a matchbox, gives loud, clear reception of the BBC Home, Light and Third Programmes on the medium waveband, about 180-550 metres. No catwhiskers, valves or batteries are required, and the receiver works off a short indoor aerial in most districts. Many unsolicited testimonials.

PRICE **9/-** POSTAGE AND PACKING 6d. EXTRA
 This offer applies only to Gt. Britain and Northern Ireland.

RADIO COMPONENT SERVICE,
 No. 1, SUMMER'S ROAD,
 BRISTOL, 2.

CABINETS & HI-FI EQUIPMENT

We can supply any Cabinet to your own specification.

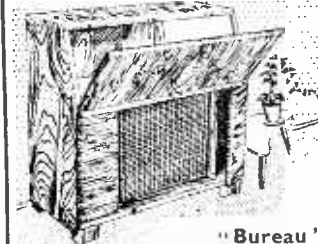

"Bureau"
£16.16.0

This ever popular walnut bureau cabinet is veneered with the finest selected Walnut and beautifully polished in a medium shade. Designed to accommodate any type of Automatic Record Changer, Tape Deck, Amplifier, chassis, etc., and to give generous storage compartments.
 We can also supply and fit this or any cabinet with the latest Hi-Fi amplifiers, tuners, transcription units, record changers, speakers, etc.
 Send for comprehensive illustrated catalogue of cabinets, autochangers, speakers, etc., all available on easy H.P. terms.

LEWIS RADIO COMPANY
 120 (PW9) Green Lanes, Palmers Green
 London N13 Tel: BOWES Park 1155.8

TRANSISTORWISE

"RECO" ONE TRANSISTOR KIT

A low cost beginner's radio. Kit includes all parts, transistor, diode, and super sensitive Bell-Phone for private listening, neat plastic case and 1.5 v. battery for months of dependable listening. Only 29/6.

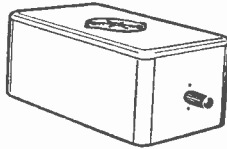

"RECO" TRANSISTOR 3 PORTABLE

receives home and continental stations. Ferrite rod aerial. Attractive plastic case, balanced armature output unit and all parts. 55/- inc. battery.

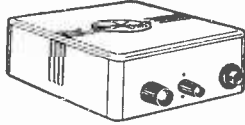

"RECO" PORTABLE TRANSISTOR 3

Similar specification to the "Reco" 3, but uses high gain frame aerial mounted on metal chassis. Has variable gain control. 65/- buys all parts, case, and battery.

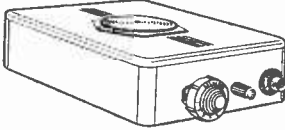

All parts sold separately. Wiring circuit parts price list, 1/- each, P.O. only.

Please note NEW address.

RADIO EXCHANGE CO.

(Dept. PW)

27 HARPER STREET, BEDFORD

(MAIL ORDER & TRADE ONLY)

BRAND NEW AMERICAN TEST KITS, each kit comprising the following units:

Absorption Frequency Meter BC-906. 150-235 mc/s, individually calibrated—contains 1 valve 155.
Test Oscillator I-196. 150-235 mc/s—contains 1 valve 957.
Receiver BC-1086. 150-235 mc/s—consists of 2 detectors 957 and amplifier 1D8G7, gives sufficient output for Headphones.
Range Calibrator BC-949. Oscillator tunable from 8 to 61 kc/s—contains one each 6SL7G7 and 6H6.
Indicator Unit BC-936. Diode Rectifier (957) for signals from 150 to 235 mc/s with video output.

PRICE of all five instruments only £5.10.0
 Packing and carriage, £1.0.0.

All the above units are battery operated.

BRAND NEW A.C. MAINS POWER PACKS for 200 250 v. Mains, fully suppressed; output 300 v. at 200 mA D.C. and 12 v. at 3 amps. A.C. PRICE £3.0.0.

EDDYSTONE COMMUNICATION RECEIVERS 359X. 40 kc/s. to 31 mc/s, fully tested, complete with set of ten plugs in coils ... £12.10.0
 Packing and carriage ... £1.0.0

PLUG-IN COILS FOR THE ABOVE RECEIVERS, all ranges Set of ten coils in wooden tray ... each 17.6
 Packing and carriage ... per coil 1/-

SIMPLE TWO-DECADE WHEATSTONE BRIDGES. Range 0 to 200 ohms in one ohm steps with built-in Galvanometer. 2.5-0-2.5 mA ... £2.10.0
 Carriage ... 7.6

METERS
 2 1/2" Centre zero plain scale 600 microamps Galvanometers, projection mounted, plug-in type ... each 12.6
 2" round flush mounted Milliammeter, 0-1 mA., enclosed in a rectangular steel box 2 1/2" square, with 5ft. lead terminated with a 2-pin socket ... each 20-
 2 1/2" round projection mounted Milliammeter, 0-500 mA. ... each 8.6
 In matched resistance ... 22.6

HEADSETS, C.L.R. CHR. D.L.R. HS30, HS33, HS33 from 6/- each
CARBON HAND MICROPHONES (no switch) each 5.6

Z & I AERO SERVICES LTD

14 South Wharf Road, Paddington, London W.2

Tel. A.M.B. 5500 0151, 2 Grams: ZAERO W2 LONDON

WIRING ACCESSORIES

Return of Post Service. Lowest possible prices consistent with high quality. Money back guarantee.

PVC Cable Flat Twin With E. 3 Core

1.044	£2.8.1.	£3. 2. 0	£3. 9. 3
3.025	£3.4.8	£3.14. 4	£4.13. 0
3.636	£4.7.6	£4.17. 6	£6. 6. 7
7.025	£5.9.3	£6.16.11	£3. 2. 11

TRS CABLE

1.044	£2.10.5	£3. 6. 8	£3.15. 4
3.025	£3. 9. 3	£4. 3. 1	£5. 3. 5
3.636	£4.11.4	£5. 6. 1	£6.15. 0
7.025	£5.11.1	£6.18.10	£8. 4. 0

Prices per 100 yds. All sizes stocked. Supplied in 25, 50, 75 or 100 yd. lengths. 7,025 and above cut to length—no cutting charge. Full range of accessories available. Send for complete lists.

F. HUNT & CO.

STEPCOTE HILL, EXETER

Phone: Exeter 56897

RES/CAP. BRIDGE 35/-

Checks all types of resistors and condensers.

Easy to Build Up Easy to Use
READY CALIBRATED

Stamp for details of this and other kits.

RADIO MAIL (Dept. R)

Raleigh Mews, Raleigh Street, Nottingham

VALVES—Guaranteed

EA50	2 - U22	8 - 8BH6	5 - 8U7	5 -
ERC33	7 6 U24	11 6 6BW8	6 6 6V6	6 -
EC338	8 6 UUG	10 - 6C5	6 - 6X5	7 6
EF36	5 6 VR65	3 6 6D2	7 - 7D8	7 6
EF37	7 6 VR65A	3 6 6F1	11 - 8D2	4 6
EF39	5 6 VT20	3 6 6F12	8 - 8D3	8 -
EF50	5 - VU111	2 6 6F13	11 6 9D2	8 -
EF91	8 - W77	5 - 6J5	6 - 9D6	5 -
EL32	5 - OZ4	5 - 6KTG	4 6 12BA6	7 6
PCC84	1U5	6 6 8K7M	5 6 12BE6	6 -
	11 - 3D6	4 6 6SA7	8 - 12BH7	7 6
	9 0 4D1	7 6 6SN7GT	12 17	8 6
PY31	10 - 6AK6	7 6	8 6 12K7	8 -
SP41	4 - 6AL5	7 -	7 6 151D2	6 -
SP61	6 - 6AM6	8 - 6U5	7 6 50C5	8 6
T41	8 6 6B8	6 - 6U3(UX)	6 6 50L6	8 6
TT11	3 6 6BE5	7 -	7 6 50L6	8 6

Postage 8d. per valve. (Also all components)
 TV Tubes, Perfect Condition (callers only)
 MW22 16, MW22 18, £4.0.0 each. Also all Transistor Components.

TELEKIT SUPPLY

104 High Street, Beckenham, Kent.
 Phone: BEC 3720

High sensitivity Miniature moving coil

LOUDSPEAKER

As used in the Perdio Pocket Transistor Radio. Diameter 2 1/2 in. Depth 1 3/16 in. Impedance 3 ohms. Price, including tax, post and packing, 27/6. Cash with order.

For this and other miniature components apply:

Specialised Electrical Components,

9-11, Monmouth Street, London, W.C.2.

NEW! NEW! NEW!

THE "WAVEMASTER" TRANSDORISED SUPERHET PORTABLE

ULTRA-MODERN DESIGN
 INCORPORATING Highly Efficient Frequency Changer

Double Tuned I.F.T.'s: 470 Kc/s.
 MATCHED "PERMACO" COILS FOR HIGHEST STAGE GAIN.
 Transistor Detection and A.V.C.
 Built-in Ferrite Aerial M/L Wave.
 Tin x 4in. Hi-Flux Elliptical Speaker.
 Negative Feedback.
 Push-Pull Output 250 Milliwatts.
 Negligible Running Costs.

OPERATES ANYWHERE ANYTIME

A Receiver for the Home Constructor in Advance of Present-day Design.
 All Items including Cabinet available.
 All Components sold separately.
 Comprehensive Assembly Data and Components List, 1/6.

OLYMPIC RADIO COMPONENTS LTD.

224 Hornsey Rd., Holloway, London, N.7.

1-Finger Pianists

Build your own electronic keyboard and play everything! Send for free leaflet. Guitar, cello, flute and trumpet are all easy. Write now...

C & S, 10 Duke St., Darlington, Co. Durham

Practical Wireless

BLUEPRINT SERVICE

PRACTICAL WIRELESS

*No. of
Blueprint*

CRYSTAL SETS

- 2/- each
- 1937 Crystal Receiver ... PW71*
- The "Junior" Crystal Set ... PW94*
- 2/6 each
- Dual-Wave "Crystal Diode" ... PW95*

STRAIGHT SETS

Battery Operated

- One-valve : 2/6 each
- The "Pyramid" One-valver (HF Pen) ... PW93*
- The Modern One-valver ... PW96*
- Two-valve : 2/6 each
- The Signet Two (D & LF) ... PW76*

- 3/6 each
- Modern Two-valver (two band receiver) ... PW98*

- Three-valve : 2/6 each
- Summit Three (HF Pen, D Pen) ... PW37*

- The "Rapid" Straight 3 (D, 2 LF (RC & Trans)) ... PW82*

- F. J. Camm's "Sprite" Three (HF, Pen, D, Tet) ... PW87*

- 3/6 each
- The All-dry Three ... PW97*
- Four-valve : 2/6 each
- Fury Four Super (SG, SG, D, Pen) ... PW34C*

Mains Operated

- Two-valve : 2/6 each
- Selectone A.C. Radiogram Two (D, Pow) ... PW19*

- Three-valve : 4/- each
- A.C. Band-Pass 3 ... PW99*

- Four-valve : 2/6 each
- A.C. Fury Four (SG, SG, D, Pen) ... PW20*

- A.C. Hall-Mark (HF Pen, D, Push Pull) ... PW45*

SUPERHETS

- Battery Sets : 2/6 each
- F. J. Camm's 2-valve Superhet ... PW52*

- Mains Operated : 4/- each
- "Coronet" A.C.4 ... PW100*
- AC/DC "Coronet" Four ... PW101*

*No. of
Blueprint*

SHORT-WAVE SETS

Battery Operated

- One-valve : 2/6 each
- Simple S.W. One-valver ... PW88*
- Two-valve : 2/6 each
- Midget Short-wave Two (D, Pen) ... PW38A*

- Three-valve : 2/6 each
- Experimenter's Short-wave Three (SG, D, Pow) ... PW30A*

- The Prefect 3 (D, 2 LF (RC and Trans)) ... PW63*

- The Band-spread S.W. Three (HF, Pen, D, (Pen), Pen) ... PW68*

PORTABLES

- 2/-
- The "Mini-Four" All-dry (4-valve superhet) ... *

MISCELLANEOUS

- 2/6 each
- S.W. Converter-Adapter (1 valve) ... PW48A*

- The P.W. 3-speed Autogram ... (2 sheets), 8/-*
- The P.W. Monophonic Electronic Organ (2 sheets), 8/-

TELEVISION

- The "Argus" (6in. C.R. Tube), 3/-*
- The "Super-Visor" (3 sheets), 8/-*
- The "Simplex" ... 3/6*
- The P.T. Band III Converter 1/6*

All the following blueprints, as well as the PRACTICAL WIRELESS numbers below 94 are pre-war designs, kept in circulation for those amateurs who wish to utilise old components which they may have in their spares box. The majority of the components for these receivers are no longer stocked by retailers.

AMATEUR WIRELESS AND WIRELESS MAGAZINE

STRAIGHT SETS

Battery Operated

- One-valve : 2/6
- B.B.C. Special One-valver ... AW387*

Mains Operated

- Two-valve : 2/6 each
- Consoelectric Two (D, Pen), A.C. ... AW403

SPECIAL NOTE

THESE blueprints are drawn full size. The issues containing descriptions of these sets are now out of print, but an asterisk denotes that constructional details are available, free with the blueprint.

The index letters which precede the Blueprint Number indicate the periodical in which the description appears. Thus P.W. refers to PRACTICAL WIRELESS, A.W. to Amateur Wireless, W.M. to Wireless Magazine.

Send (preferably) a postal order to cover the cost of the Blueprint (stamps over od, unacceptable) to PRACTICAL WIRELESS, Blueprint Dept., George Newnes, Ltd., Tower House, Southampton Street, Strand, W.C.2.

*No of
Blueprint*

SHORT-WAVE SETS

Battery Operated

- One-valve : 2/6 each
- S.W. One-valver for American ... AW429*

- Two-valve : 2/6 each
- Ultra-short Battery Two (SG, det Pen) ... WM402*

- Four-valve ; 3/6 each
- A.W. Short Wave World-beater (HF Pen, D, RC, Trans) ... AW436*

- Standard Four-valver Short-waver (SG, D, LF, P) ... WM383*

Mains Operated

- Four-valve : 3/6
- Standard Four-valve A.C. Short-waver (SG, D, RC, Trans) ... WM391*

MISCELLANEOUS

- Enthusiast's Power Amplifier (10 Watts) (3/6) WM387*
- Listener's 5-watt A.C. Amplifier (3/6) ... WM392*
- De Luxe Concert A.C. Electrogram (2/6) ... WM403*

QUERY COUPON

This coupon is available until Dec. 6th, 1957, and must accompany all Queries sent in accord with the notice on our "Open to Discussion" page. PRACTICAL WIRELESS, Dec. 1957.

Published on the 7th of each month by GEORGE NEWNES, LIMITED, Tower House, Southampton Street, Strand, London, W.C.2. and printed in England by W. SPEAIGHT & SONS, Exmoor Street, London, W.10. Sole Agents for Australia and New Zealand: GURDON & GOTCH (A/sia), LTD. South Africa: CENTRAL NEWS AGENCY, LTD. Subscription rate including postage, for one year: Inland 19s., Abroad 17s. 6d. (Canada 16s.). Registered at the General Post Office for the Canadian Magazine Post.

DO IT YOURSELF—IT'S SO EASY!



47/6

Build this exceptionally sensitive double triode radio. Uses unique assembly system and can be built by anyone without any radio knowledge whatever in 45 minutes.

Handsome black-crackle steel case with specially made black and gold dial with stations printed. Size of radio only 6 1/2 in. x 5 in. x 3 in. Covers all Medium and Long waves—uses only one all-dry battery. H.T. consumption only 1 to 1.5 mA. Uses personal phone. Ideal for Bedroom, Garden, Holiday, etc.

Many unsolicited testimonials. Mr. Norton of Oxford writes: *Yesterday coming on the Medium waveband, I counted 22 separate stations. I am very pleased with the set, which is well worth the money. BUILD THE "SKYROMA" NOW!* Total building cost—everything down to just nut and bolt—47/6 (Postage, etc., 2/-) with full set of clear, easy-to-follow plans. (Parts sold separately. Priced Parts Lists, etc., 1/6.)

BRAND NEW CHANGERS £9-8-6!



LIMITED QUANTITY ONLY! In maker's sealed cartons. List price £13.17.0. The famous "Collaro" 4-speed autochange unit, Model 456. Incorporates Studio "O" high-fidelity turn-over crystal pick-up, the new manual and fully automatic control on all four speeds. Constant speed change cycle on all records. Designed so that there is a gentle lowering of the stack of the records on to the step of the spindle to avoid damage and wear to the centre holes of records. Size only 12 in. x 13 in., clearance required above base-board only 5 in., clearance below only 2 in. **RUSH YOUR ORDER NOW! ONLY £9.8.6. plus 4/6 Post and Packing.**

LOOK!



BUILD THIS POCKET RADIO FOR ONLY 37/6

AT LAST! In response to many requests we now present the **DOUBLE TRIODE "SKYPOCKET,"** a beautifully designed precision **POCKET RADIO.** No radio knowledge needed!—**EVERY SINGLE PART TESTED BEFORE DESPATCH!** Our simple, pictorial plans take you step-by-step. This set has a remarkable sensitivity due to painstaking design. Covers all medium waves 200 to 550 Metres. Size only 5 1/2 in. x 3 in. x 2 in. In Strong, Transparent case with panel, cover and ivory dial. A really personal-phone, pocket-radio. **WITH DETACHABLE ROD AERIAL.** Self-contained all-dry battery operation. Average building time 1 hour. **Total Building Cost—including Case, Double Triode Valves, etc., in fact, everything down to the last nut and bolt—ONLY 37/6, with plans, Postage, etc., 2/- C.O.D. 1/6 extra.** (Parts sold separately. Priced Parts List, etc., 1/6.) Demand is certain to be heavy—**so SEND TO-DAY!**

Build This TRANSISTOR POCKET SET For Only 47/6!



ONLY £8-12-6

BRAND NEW—NOT SURPLUS! In maker's sealed cartons. Latest UAB "Monarch" 4-speed record-player complete with high-fidelity "turnover" head. Type HGP 37—1. Capacity of 10 Records, plays 12 in., 10 in. and 7 in. Intermixed in any order. 78, 45, 33 $\frac{1}{2}$ and 16 r.p.m. For A.C. mains 100 to 250 volts. **Exclusive "magdisk" selector gives quickest and quietest change ever.** With full instructions and fixing plans. **Limited quantity at £8.12.6. plus 4/6 Post, Packing, etc. WHY PAY MORE! SEND NOW WHILE STOCKS LAST!**

—modernise your radiogram and increase its value.

WE'VE DONE IT AGAIN!

our design department in response to a great many requests have designed this "SKY-PIXIE" Vest-Pocket **TRANSISTOR RADIO** which gives a good performance. Size only 4 1/2 in. x 3 1/2 in., the weight under 7 ozs. —yet it is a **TWO-STAGE** receiver covering all medium waves, working entirely off a tiny "pen-light" battery, which costs 6d.—fits inside the case—and lasts many months. Uses personal phone and has push-button **LUMINOUS On/Off Switch.** Every part tested before despatch! **SPECIAL STEP-BY-STEP PLANS for ABSOLUTE BEGINNERS.** Total building cost including case, transistors, etc.—everything down to the last nut and bolt—**ONLY 47/6 with plans.** Postage etc., 2/- C.O.D. 1/6 extra. (Parts sold separately. Priced parts list, etc., 1/6.) As the building cost is absolutely "rockbottom" (it might increase later) **DEMAND WILL BE VERY HEAVY—RUSH YOUR ORDER TO-DAY!**

BUILD THIS TRANSISTOR SET FOR ONLY 35/-

VERY SPECIAL OFFER WHILE STOCK OF PARTS LASTS!—The "Sky-Scout" Pocket. Two-stage transistor set, size only 4 in. x 3 1/2 in. x 4 1/2 in. Covers all medium-waves and works entirely off tiny "pen-light" battery which costs 6d. and fits inside case. All parts tested before despatch. Can be built for 35/-, plus 2/- post and packing, including Case, Transistor, **STEP-BY-STEP PLANS FOR ABSOLUTE BEGINNERS,** nuts, bolts, etc. (C.O.D. 1/6 extra.) Parts sold separately, priced parts list, etc., 1/6. **VERY SIMPLE TO BUILD.**

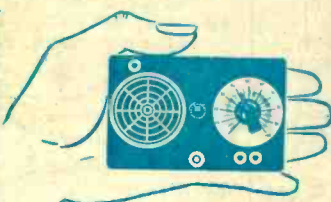

FEW ONLY AT 95/-!

NEW in maker's sealed cartons!—limited quantity of the famous 3-speed record player units, exceptionally easy to fix, with lightweight pick-up, incorporating "Acos" crystal turnover head and separate sapphire styl for Standard and Long-Playing. With full instructions and fixing plans. **Unbeatable price 95/-, plus 3/6 Post, Packing, etc. C.O.D. 2/- extra. RUSH YOUR ORDER NOW—BEFORE IT'S TOO LATE!**



CONCORD ELECTRONICS

69, PRESTON STREET, BRIGHTON

Dept. PWP

Orders receive prompt attention. Cheques accepted. Cash on delivery 1/6 extra. Please print name and address in block letters. Component suppliers to Schools, Universities, Government Research Establishments. Complete range of components stocked. **CALLERS WELCOME: Shop Hours: 9 a.m. to 6 p.m. (1 p.m. Thursday). Regret no Goods sent abroad.**