

A TRANSISTOR-DIODE PORTABLE

# PRACTICAL <sup>1/3</sup> WIRELESS

AUGUST  
1956

EDITOR: F.J. CAMM

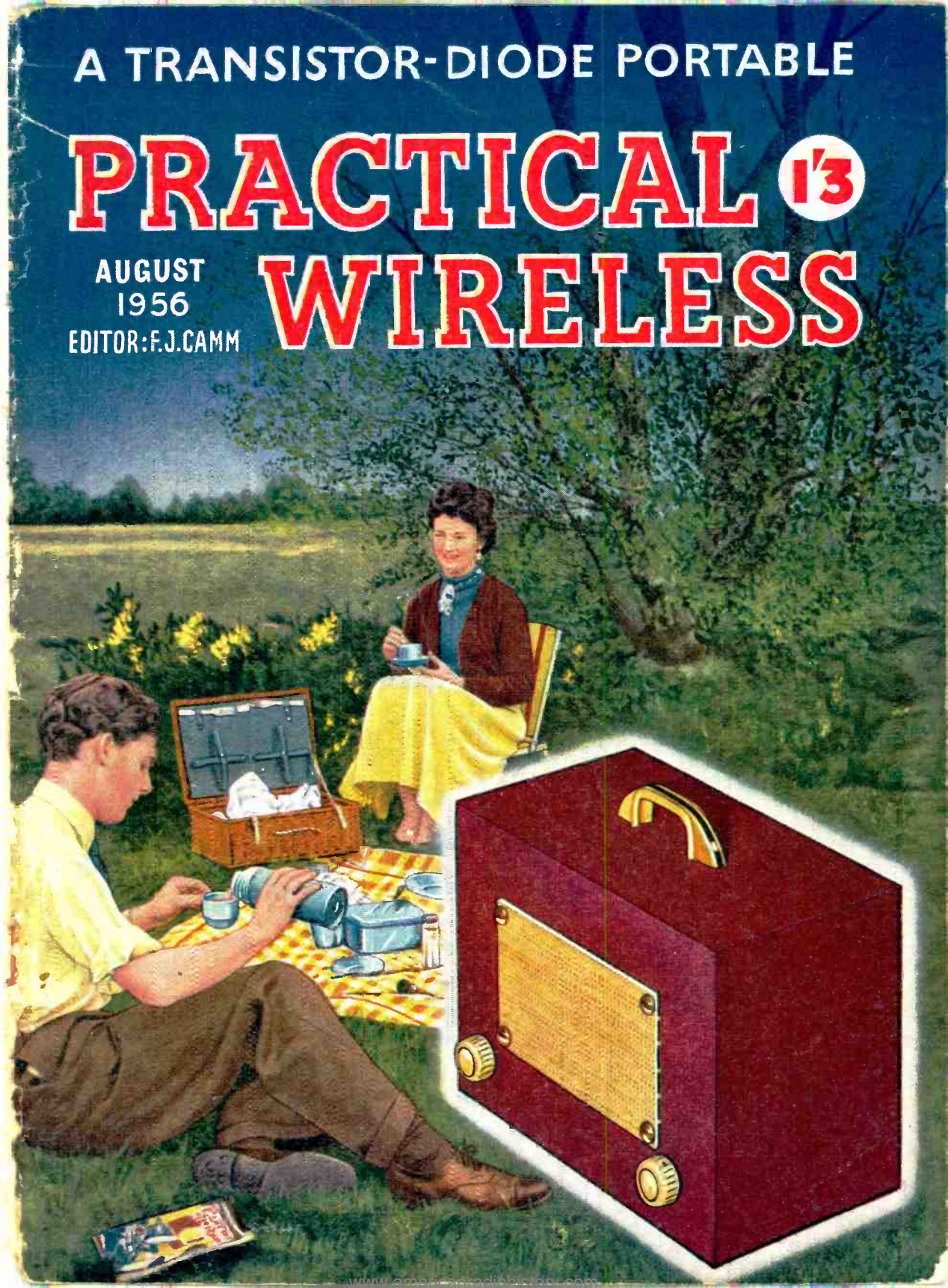

# Supreme in Service

## 'MICROMITE'

### DRY ELECTROLYTIC CONDENSERS

These small but high quality electrolytics have proved so popular that the range has been greatly extended. The use of high-gain etched foil electrodes keeps size and weight down, making the condensers suitable for suspension wiring. Conservatively rated; long shelf life ensured; green plastic insulating sleeving prevents short-circuits.

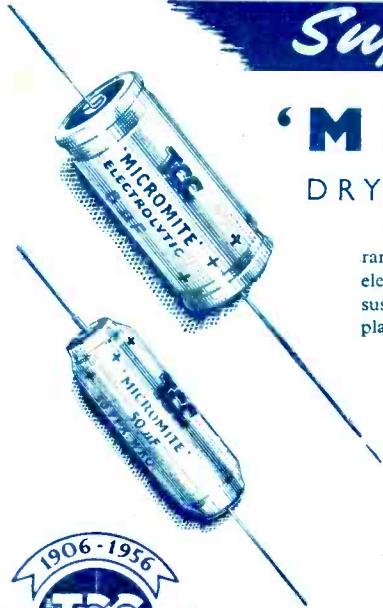

Capacity in $\mu$ F.	Peak Wkg. Volts	Surge Volts	Dimns. in Ins.		Type No.	List Price Each
			Length	Diam.		
50	12	15	1 1/2	3/8	CE87B	2/9
25	50	60	1 1/2	3/8	CE88DE	3/-
1	350	400	1 1/2	3/8	CE86L	2/6
8	350	400	1 1/2	3/8	CE99LE	3/3
16	350	400	2 1/2	3/8	CE91LE	4/-
32	350	400	2 1/2	3/8	CE93LE	6/-
4	450	550	1 1/2	3/8	CE99PE	3/3
8	450	550	1 1/2	3/8	CE90PE	3/6
16	450	550	1 1/2	3/8	CE92PE	5/-
32	450	550	2 1/2	3/8	CE94PE	7/6



## THE TELEGRAPH CONDENSER CO. LTD

RADIO DIVISION : NORTH ACTON · LONDON · W.3 · Telephone : ACOrn 0061

## High Fidelity at Realistic Cost!



Tweeter Units  
£4. 4. 0 &  
£12. 12. 0

H.F. 1012. 10" Hi-Fi Unit £4. 19. 9

H.F. 1214. Full range 12" Unit 14,000 gauss £9. 15. 6

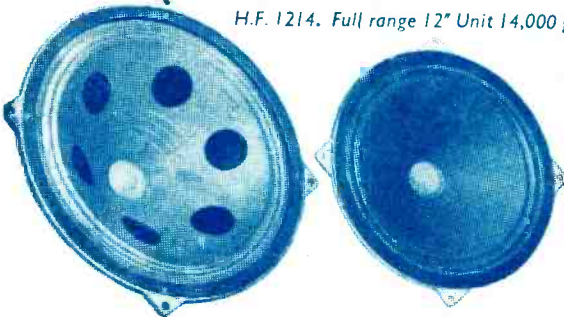

The New W.B.12  
High Fidelity  
Amplifier  
Price £25

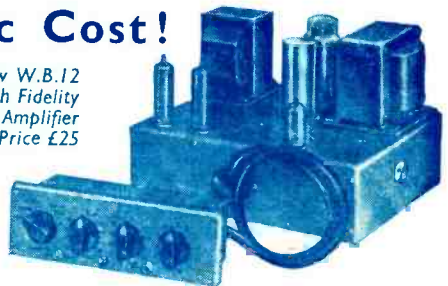

Ready to assemble Cabinets from  
£5. 10. 0

TV and Record Storage Cabinets  
£9. 14. 3 & £10. 4. 9

★  
Details of all the outstanding  
W.B. products on request.

T816. Special 8" Mid-Range  
and High Frequency Unit  
16,000 gauss magnet. £6. 10. 0



WHITELEY ELECTRICAL RADIO CO. LTD · MANSFIELD · NOTTS



# 'AVO' Precision ELECTRICAL TESTING INSTRUMENTS

A dependably accurate instrument for testing and fault location is indispensable to the amateur who builds or services his own set.

## The UNIVERSAL AVOMINOR

(as illustrated) is a highly accurate moving-coil instrument, conveniently compact, for measuring A.C. and D.C. voltage, D.C. current, and also resistance; 22 ranges of readings on a 3-inch scale.

Size: 4 1/2 ins. x 3 3/4 ins. x 1 1/2 ins.  
 Nett weight: 18 ozs.

Complete with leads, interchangeable prods and crocodile clips, and instruction book.

List Price: £12 : 0 : 0

## The D.C. AVOMINOR

is a 2 1/2-inch moving coil meter providing 14 ranges of readings of D.C. voltage, current and resistance up to 600 volts, 120 milliamps, and 3 megohms respectively. Total resistance 100,000 ohms.

Size: 4 1/2 ins. x 3 3/4 ins. x 1 1/4 ins.  
 Nett weight: 12 ozs.

Complete as above  
 List Price: £5 : 5 : 0

**MODEL 1**  
 D.C. VOLTAGE: 0 to 500 volts.  
 A.C. VOLTAGE: 0 to 500 volts.  
 D.C. CURRENT: 0 to 500 mA.  
 RESISTANCE: 0 to 20,000 Ω.  
 Total resistance of meter: 200,000 Ω.  
 SENSITIVITY: 400 Ω/V.

**MODEL 2**  
 D.C. VOLTAGE: 0 to 1,000 volts.  
 A.C. VOLTAGE: 0 to 1,000 volts.  
 D.C. CURRENT: 0 to 500 mA.  
 RESISTANCE: 0 to 200,000 Ω.  
 Total resistance of meter: 4 MΩ.  
 SENSITIVITY: 4,000 Ω/V.

**RADIO SHOW**  
 Stand No.

**3**

Write for a free copy of the latest Comprehensive 'Guide to 'Avo' Instruments.

Sole Proprietors and Manufacturers :-  
**AUTOMATIC COIL WINDER & ELECTRICAL EQUIPMENT CO., LTD.**  
 Avocet House, 92/96, Vauxhall Bridge Rd., London, S.W.1. VICtoria 3434 (9 lines)

**MAXI-Q**  
 REGD.

# COIL PACKS

CP.3/370pF and CP.3/500pF. These 3 waveband Coil Packs are available for use with either 370pF or 500pF tuning condensers. The coverages are: Long Wave 800-2,000 metres, Med. Wave 200-550 metres, Short Wave 16-50 metres. Designed for use with Jackson Bros. Full Vision Drive or SL.8 Spin Wheel Drive. Retail Price of each unit: 32/- plus 12/9 P.T.—Total 44/9.

CP.3/G. As above but with Gram. position, suitable for use with 500pF tuning condenser: 39/- plus 15/7 P.T.—Total 54/7.

CP.3/F. This Coil Pack is for use with a 500pF tuning condenser and covers the standard Long, Med, and Short wavebands with the addition of the band 50/160 metres. This covers the Trawler Band, Aeronautical and the 80 and 160 metre Amateur bands: 49/- plus 19/7 P.T.—Total 68/7.

CP.3F/G. As CP.3/F but with gram. position: 57/- plus 22/9 P.T.—Total 79/9.

CP.4/L and CP.4/M. These compact 4-station Coil Packs are available for either 1 Long Wave and 3 Medium Wave stations (CP.4/L) or 4 Medium Wave stations (CP.4/M). They are fully wired and require only four connections for use with any standard frequency change valve. 25/- plus 10/- P.T.—Total 35/-.

CP.4L/G and CP.4M/G. As CP.4/L and CP.4/M but with provision for Gram. position. 31/- plus 12/5 P.T.—Total 43/5.

See Technical Bulletin DTB.9 for details of all Coil Packs, 1/6.

Available from all reputable stockists or direct from Works. Send 1/- in stamps for General Catalogue covering full range of components.

## DENCO (CLACTON) LTD, 357/9 OLD RD., CLACTON-ON-SEA, ESSEX

STOP PRESS: MAXI-Q F.M. TUNER UNIT assembled and valved at £9/19/6 inc. Power Pack at £3. OSRAM F.M. TUNER completely assembled and valved at £30/16/0 inc. MULLARD 3 VALVE 3 WATT HI-FI AMPLIFIER 16 swg Aluminium punched chassis. 10/6. Complete metalwork for the T.C.C. Printed Circuit version of the OSRAM 912 and MULLARD 5-10 AMPLIFIERS, 15/-.  
 MULLARD 5-10 Type "A" and "B" pre-amplifiers.—Chassis and Printed Gold Finished Front Panel, Type "A" 8/6, Type "B" 12/6. Separate printed Gold finished Panels available, Type "A" 1/6, Type "B" 2/6.

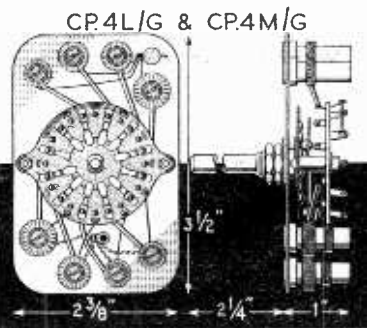

**3-WAVE SUPERHET**

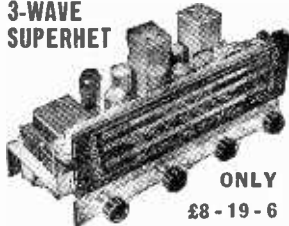

**ONLY £8-19-6**

This is a 5-valve A.C./D.C. superhet covering the usual long, medium and short wavebands. It has a particularly fine clear dial with an extra long pointer travel. Osram valves are used and the chassis is complete and ready to operate. Chassis size 15 x 6 x 6in. Price £8 19 6, complete with 8in. or 6in. speaker. Carriage and insurance 16/- . H.P. terms if required.

**CHASSIS ASSEMBLY**



Three-colour 3-waveband scale covering standard Long, Medium, and Short wavebands, scale pan, chassis, punched for standard 5-valve superhet, pulley driving head, springs, etc., to suit. Scale size 14 1/2 x 3 1/2in. Chassis size 15 x 6in. x 2in. deep. Price 15/- plus 1/6 post. Note.—This is the one that fits our 47.6 table cabinet.

**NEW CIRCUIT**

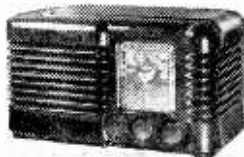

**OCCASIONAL 56**—we have evolved a new T.R.F. circuit and have had really good results, equal in fact to many superhets. You really should try this circuit. All parts including valves (6K7, 6J7, 6F6, and 6X5) and Bakelite case with back cost only £5 10/- . plus 2/6 post and insurance. Data included with the parts is also available separately, price 2/- .

**THE CLEVELAND ORGANTONE**



5 valve 3 waveband superhet covering Long, Medium and Short waves. Osram miniature valves—low loss iron coils—permeability—tuned I.F.S.—full A.V.C.—variable negative feed-back—gram. position—4 watts out-put—particularly fine tone. Chassis size 7in. x 7in. x 7in. approx. Tested in difficult areas, where exceptional results have been obtained. Price £11 10/0 or £3 16/0 deposit. Carriage and ins. 10/- .

**STOP PRESS SNIP**

1 MFD 350v. Tubular Metal Case Condenser 3/- per dozen, gross lots post free otherwise add 1/- .

**CABINETS FOR ALL**

We undoubtedly hold the largest stock of cabinets in the country. All are made of the finest plywood, veneered and polished and all radio and

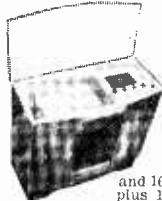

motor boards are left uncut to suit your own equipment. The top one is The Bureau, walnut finished and highly polished, size approximately 30in. high, 32in. wide, and 16in. deep. Price 16 guineas plus 15/- carriage and insurance.

**RECORD PLAYER £4/10/0**

3-speed Gramophone Motor



Latest rim drive 3-speed motor with metal turntable and rubber mat. Small mod. makes speed easily variable for special effects and dance work. **Hi-Fi Pick-up** Using famous Cosmocord Hi-Q turn-over crystal. Separate sapphire for each speed. Neat bakelite case with pressure adjustment. **Special Snip Offer This Month** The two units for £4 10/- . plus 5/- post and insurance, or made upon board as illustrated. £5 10/- . plus 5/- post.

**THIS MONTH'S SNIP RADIO SCALES 6/6 DOZEN**



An exceptional bargain this month is our assorted parcel of radio scales. A most useful collection for all who make up experimental or other radios. We offer twelve assorted scales mostly in two or three colours for 6/6 plus 2/6 post and packing. Limited quantity only.

**VACUUM RELAY**

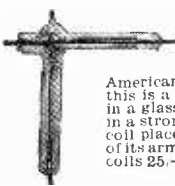

American made type No. C.61610, this is a relay completely sealed in a glass envelope. It will close in a strong magnetic field or by a coil placed close to or round one of its arms. Price 49/6. Operating coils 25/- each.

**OFFICE TELEPHONES**

New G.P.O. telephone sets with internal bell and push button switch easily connected together to form office intercom. Price £2 10/0 each. Post etc., 2/6.



**IMPULSE RELAY**

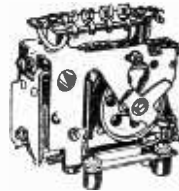

Somewhat soiled due to storage but mechanically O.K. Price 2/6. few new and unused 6/6 each, plus 9d. post. Booklet giving some circuits price 1/- post free.

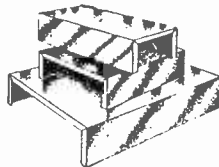

**BLANK CHASSIS 18 S.W.G. Aluminium**

7 x 3 1/2 2.....	3/8	14 x 10 x 3.....	7/9
9 1/2 x 4 1/2 21....	5/-	16 x 10 x 3.....	8/3
10 x 8 21.....	5/6	16 x 12 x 3.....	8/8
10 x 5 1/2 21.....	5/-	19 1/2 x 21.....	8/3
12 x 9 21.....	7/-	20 x 10 x 3.....	10/-
14 x 9 x 21.....	7/6		



**CONNECTING WIRE**

P.V.C. covered in 100ft. coils—2/9 a coil or four coils different colours, 10/- post free.

**FINE TUNERS**

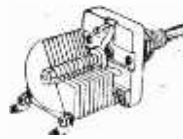

Ceramic trimmers: all with 1in. spindles of fair length. 5, 10, 15, 30. P.F. at 2/3 each or 24/- per dozen.

**W.D. CIRCUIT DETAILS**

Diagrams and other information extracted from official manuals. All 1/6 per copy, 12 for 15/- . American Service

- Sheets
- R.109
- BC 348
- BC 312
- R.103A
- B.C.342
- RA-1B
- R-208
- R-1155
- R-1124A
- R-1132A/R-1481
- R-1147
- R-1224A
- R-1082
- R-1355
- B.C.1206-A/B
- B-455-A (or -B)
- B-454-A (or -B)
- B-453-A (or -B)
- Transmitter T1154
- Fifty-eight walkie talkie
- Frequency meter B.C.221
- R.76 receiver
- 76 receiver
- R26-ARC5
- R1116A
- RA-1B
- AR88D
- AN:APA-1
- 76
- R.T.18
- CAY-46-AAM
- RADAR
- A.S.B.-3
- Indicator 62A
- Indicator A.S.B.3
- Indicator 62
- R.F. unit 24
- Indicator 6K
- R.F. unit 24
- Transmitter T1154
- R.F. unit 26
- R.F. unit 25
- R.F. unit 27
- Wireless set No.19
- Demobted valves

**HUGE MINISTRY PURCHASE**

R.1155—yours for £2 down

Frequency 75 kc's to 18 mc's—10 Valves—metal case—robust receiver—cost over £80 to make—will give you 5 years of service.



Very little used. Price £10 or 5 payments of £2. (Carriage transit case 15/- ex.)

**ENGINEERS 1" MICROMETER**

Brand new and perfect—invaluable to engineers, apprentices, model makers, students, etc. Only 10/- post free.

**5-VALVE SUPERHET YOURS FOR ONLY £1 DOWN**

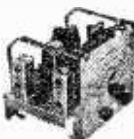

Chassis size approx. 9 1/2" x 7 1/2" x 8". First-class components. A.C. mains operation. Three waves (medium and two shorts). Complete with five valves, ready to work. New and unused. Cash price £5 19/6. or 6 payments of £1 (carr. and ins. 7/6).

**TRANSFORMER SHIP**

11/6

Post 2/-

Fully shrouded—standard 200-250 v. primary 200-0-280 at 80 m.a. 6.3 v. at 3 amp., 5 v. at 2 amp.



**HIGH VOLTAGE TESTER**



An instrument that will measure voltages up to 10,000 but which draws no current from the source, will probably be a valuable addition to your workshop equipment. It can be made entirely from odds and ends. Booklet giving full instructions, plans, etc., 2/6 post free.

**MAINS-MINI**



Uses high-efficiency coils—covers long and medium wavebands and fits into the neat white or brown bakelite cabinet—limited quantity only. All the parts, including cabinet, valves, in fact, everything, £4 10/0, plus 3/6 post. Constructional data free with the parts, or available separately 1/6.

**The "CRISPIAN" Portable Radio**



A 1-valve truly portable battery set with very many good features as follows: Ferrite rod aerials, low consumption valves, superhet circuit with A.V.C., ready-built and aligned chassis if required, beautiful two-tone cabinet covered with I.C.I. Rexine and Tysan. Guaranteed results on long and medium waves anywhere.

All parts, including speaker and cabinet, are available separately or if all ordered together the price is £7.15 complete, post and ins. 3/6, ready-built chassis 80/- extra. Instruction booklet free with parts or available separately price 1/6.

**GRAMOPHONE AUTO-CHANGERS**

The latest models by very famous manufacturers. 3-speed with crystal turn-over pick-up, brand new and perfect, in original cartons. Prices from £7/15/0, carriage, ins., etc., 7/6.

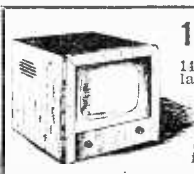

**14" T.V. CABINET**

14in. T.V. cabinet of the latest styling made for one of our most famous firms—beautifully veneered and polished—limited quantity—19/6 each. Carriage and packing 3/6 extra.

**THE STATESMAN**



**THIS IS ON OFFER AT APPROX. HALF COST TO MAKE.**

An impressive costly looking cabinet originally designed for T.V. but simple modification makes the cabinet suitable for radio-gram amplifier, tape recorder, or reflex speaker—size 23in. wide, 22in. deep and 37in. high. Limited quantity at £9 15/- each, carriage 12/6.

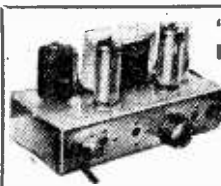

**"The ESTRONIC" Band III Converter**

To-day's best value in Band III converters suitable for your T.V. or money refunded. Complete ready to operate, 59/6 non mains or 85/- mains, post and insurance 3/6.

**THE CLEVELAND F.M. TUNER**

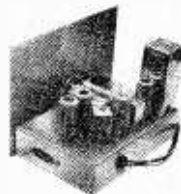

This tuner is based upon the very successful circuit published by Data Publications. We have made up models at all branches and will gladly demonstrate. Stability is extremely good and making and aligning most simple. Cost of all parts including valves, prepared metal chassis, wound coils and stove enamelled scale, slow-motion drive, pointer, tuning knob, in fact everything needed is £6 12/6. Data is included free with the parts or is available separately, price 2/-.



**MULLARD AMPLIFIER "510"**

A Quality Amplifier designed by Mullard. Power output exceeds 10 watts. Frequency response almost flat from 10 to 20,000 C.P.S. For use with the Acos "Hi G" and other food pick-ups. Made up and ready to work is £12 10/-, plus 10/- carr. and insurance.

**MULTI-METER KIT**



Parts suitable for making a multimeter to measure volts, milliamperes and ohms. Kit containing all the essential items including moving-coil motor, resistors, range selector, calibrated scale, etc., etc., is only 15/-, plus 1/- post and packing.

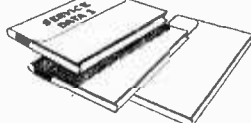

**SERVICE DATA**

100 service sheets, covering British receivers which have been sold in big quantities and which every service engineer is ultimately bound to meet. The following makers are included: Aerodyne, Alba, Bush, Cossor, Ekco, Ever-Ready, Ferguson, Ferranti, G.E.C., H.M.V., Kolster Brandes, Lissen, McMichael, Marconi, Mullard, Murphy, Philco, Philips, Pye, Ultra. Undoubtedly a mine of information invaluable to all who earn their living from radio servicing. Price £1 for the complete folder.

**ELECTRONIC PRECISION EQUIPMENT, LTD.**

Post orders should be addressed to E.P.E., LTD., Dept. 5, Sutton Road, Eastbourne.

Post enquiries to Eastbourne with stamped envelope, please.

4E-46, Windmill Hill, Rushlip Middx. Phone: ERISLIP 3780. Half day, Wednesday.

152-3, Fleet Street, E.C.4. Phone: FLEET 2833. Half day, Saturday.

29, Stroud Green Rd., Finsbury Park, N.4. Phone: ARCHWAY 1049. Half day, Thursday.

249, Kilburn High Road, Kilburn, MAIDA VALE 421.

# HOME RADIO OF MITCHAM

187, LONDON ROAD, MITCHAM, SURREY

MIT. 3282

HAVE A GAY HOLIDAY WITH THE  
"HIWAYMAN"



4 Valve All Dry Portable. Full constructional details and price list. **PRICE 1/6.**  
All parts standard and sold separately.

**ACOS.** We carry full range of pick-ups, heads, microphones, and all stylii. Despatch per return.

**HIGH FIDELITY.**—The Why and How for amateurs. A new book by Briggs, 12/6.

## HI-FI SPEAKERS

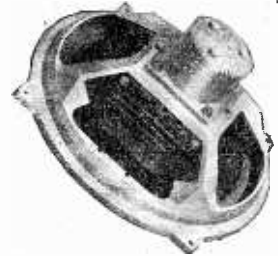

Full range of WB Stentorian speakers and cabinets, also Goodmans, Wharfedale, etc. Full details on request.

**SHORT WAVE COMPONENTS.**—We carry the full range of the

### EDDYSTONE

components and receivers including new "888." **EDDYSTONE** catalogue, 1/.

**LORENZ TWEETERS.** LPH65. Moving coil, high flux magnet. **PRICE 39/6.**

*Train for a wonderful  
future in —*

## ELECTRONICS

*Every day the demand for the expert in electronics grows. Radio, television, radar and the whole field of industrial automation are rapidly expanding, and the trained specialist assures for himself a well-paid career in this quickly developing profession. Here is your opportunity to enter for*

### 4-year course in ELECTRONIC ENGINEERING

Intended for good Science sixth-formers who are capable of training into future team leaders in scientific applications. Final qualifications are B.Sc. and City and Guilds' Full Technological Certificate in Telecommunications Engineering. This course is recognised by the Institution of Electrical Engineers. At least 18 E.M.I. Scholarships are offered for the 1956 course which commences on October 2nd.

*Train to meet the need  
for pioneers in  
this expanding field*

### 3-year course in TELECOMMUNICATIONS

Entrance standard G.C.E. Ordinary level or equivalent. This course trains Assistant Development Engineers to City and Guilds' Full Technological Certificate level. Opportunities for practical attachments to E.M.I. Laboratories and Workshops are provided. Details of special Scholarship Scheme available for next course commencing September 11th.

## The E.M.I. College of Electronics

Dept. 32, 10, Pembridge Square, London, W.2.

Telephone : BAYswater 5131/2.

The College associated with a world-wide electronics industry, including "His Master's Voice," Marconiophone, Columbia, etc.



# FOR VALVES—GUARANTEED NEW AND BOXED

9Z4	6/-	6P13	14/-	9004	5 0	6X4	12 6	PL82	11/6
1A2	6/-	6P13	14/-	9006	6/-	6X4	12 6	PL83	13/-
1A5GT	6 6	600G	4/-	951	2/-	6X4	12 6	PP255	5/-
1C2	10/6	6H6	3 6	955	4 0	6X4	12 6	PP28	15/-
1A7GT	11/6	6J5G/GT		956	3 0	6X4	12 6	PY89	10/6
1C5GT	9 6			10C2	12 6	6F37A	9/-	PY81	11 6
1H3GT	10 8	6J5M	6/-	10F1	12/6	6F22	8 6	PY82	10/6
1H4	6 0	6J6	7/6	10F9	12 6	6F30	11/-	Q21	7 6
1L6	10 0	6J7G	6 0	10H3	11 6	6F41	11/6	R19	13/6
1N5	6 0	6K6GT	7/-	12A1	6 0	6F59	11/6	SP22	6/-
1R5	8 0	6K7G/GT		12A7	9 6	6F66	13/6	U10	9/-
1S5	7 8			12A7	9 6	6F89	13/6	U22	8/-
1T4	7 6	6K7	6 0	12A7X	10/-	6H2	12 6	U25	13 6
1T5	8 0	6K8G	6 0	12B46	9 6	6H5	7 6	U48	10 6
2N2	4/-	6K8GT	6 0	12B46	10/-	6H11	11 6	UAF32	12 6
3A4	7/-	6L6G	9 0	12H6	5/-	6H4	12/-	UB41	8 6
3Q4	9/6	6L7M	7/6	12J5	6/-	6H9	5/-	UCB41	11/-
3Q5	10/-	6N7	7/-	12J7	9 6	6H11	11/6	UCB42	11/-
3D6	5/6	6Q7G/GT	9/-	12K7	9 6	6H30	11/6	UP41	11/6
3S1	8 6	6R7	9 0	12K7	9 6	6H51	13/6	UL41	11 6
3V4	8/6	6S4TGT	8/-	12Q7	9 6	6H56	13 6	UT41	10 6
4H1	3/-	6S4GT	7/6	12R7	2 6	6Z49	10/6	U79	9 6
42	8/-	6S4T	6/-	12S47	7 6	6Z41	11/-	VR21	6 6
3R40Y	9/8	6S4GT	7/6	12S47	7 6	6Z49	10 6	VR23	6 6
5U4G	8 6	6S7GT	8/-	12S47	7 6	6H48	2/-	VE24	2 6
3Y5GT	8 6	6S7	8/-	12S47	7 6	6Y91	7/-	VR35	7 6
3Z3	8 6	6S8T	8/-	12S47	7 6	PW4300		VR37	8 6
5Z4	8 9	6S9T	9 3	12S47	7 6	6Z32	12 6	VR35	3 6
6A7	11/-	6S8T	8 0	12S47	7 6	R30	5/-	VR65A	3 3
6A8GT	10 6	6U4GT	15/6	12S47	7 6	R42	5/6	VR66	3 3
6A7	6 6	6U5G	8/6	12S47	7 6	HL320	4/-	VR185YL	
6A15	6 6	6U7G	9/-	12S47	7 6	25V5	9 9	VR92	2/-
6AK5	6 6	6V6G/GT		12S47	7 6	25V6	9 9	VR105/39	
6AK7	8/-	6X4	7/-	12S47	7 6	25V6	9 9	VR116	4/-
6AL5	7/-	6X4	7/-	12S47	7 6	25V6	9 9	VR119	4/-
6AM5	5/-	6X5G/GT		12S47	7 6	25V6	9 9	VR136	7/-
6AM6	7 6			12S47	7 6	25V6	9 9	VR137	5 6
6AQ5	9/-	7B6	7/9	12S47	7 6	25V6	9 9	VR150, 30	
6AT6	8/9	7B7	9/-	12S47	7 6	25V6	9 9	VP23	8 6
6B1	5/-	7C5	8/6	12S47	7 6	25V6	9 9	VS70	3/-
6BS	4/-	7C6	8/6	12S47	7 6	25V6	9 9	VT22	8 6
6BA6	8/-	7H7	8/6	12S47	7 6	25V6	9 9	VT50	6 6
6BE6	8/-	7Q7	8/-	12S47	7 6	25V6	9 9	VU39	9 6
6BW6	8 6	7R7	8/6	12S47	7 6	25V6	9 9	VT61	9 6
6C1	7/-	7S7	9/-	12S47	7 6	25V6	9 9	VT111	3 6
6C5GT	7 6	7Y4	8/6	12S47	7 6	25V6	9 9	VU20A, 3	
6C6	8/6	75	10/6	12S47	7 6	25V6	9 9	W77	8 6
6C9	10 6	77	8/-	12S47	7 6	25V6	9 9	W61	8/-
6CH3	9/-	80	8/6	12S47	7 6	25V6	9 9	X65	10/-
6D6	7 3	807	6 6	12S47	7 6	25V6	9 9	X66	11/6
6F6G	7 6	8D2	2/6	12S47	7 6	25V6	9 9	X73	11/-
6F6M	8 6	8D2	2/6	12S47	7 6	25V6	9 9	Y63	9/-
6FL	13 6	9001	5/6	12S47	7 6	25V6	9 9	150A(B)	4 6
6FL1	13/-	9003	5 6	12S47	7 6	25V6	9 9		

## A NEW ALPHA KIT FOR YOU TO BUILD

Modern Portable. A.C./D.C. Mains/Battery Receiver. Four valves (latest types), 2 Waveband Superhet. In an attractive Lizard Grey Case, size 8 3/4 in. x 8 1/2 in. x 4 1/2 in.



Full Kit of Parts down to last nut and bolt. **£9.9.0**

Or if you prefer you can build the battery version first for £7.17.6 and add the mains components later.

Post extra on Kit, 2/6. Full Circuit Wiring, Shopping List, and Point-to-point Wiring Diagram, 2/6.

★ ★ ★ ★ ★ ★ ★ ★ ★ ★ ★ ★ ★ ★ ★ ★

## CHASSIS

Undrilled (with Reinforced Corners). Available in the following sizes:

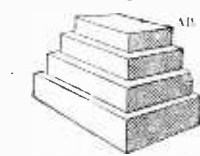

- 6in. x 4in. x 2 1/2in., each 4 5
- 8in. x 6in. x 2 1/2in., each 6 1
- 10in. x 7in. x 2 1/2in., each 7 3
- 12in. x 9in. x 2 1/2in., each 8 9
- 12in. x 6in. x 2 1/2in., each 6 1
- 12in. x 5in. x 2 1/2in., each 8 1
- 14in. x 5in. x 2 1/2in., each 6 6
- 14in. x 6in. x 2 1/2in., each 12 6
- 16in. x 6in. x 2 1/2in., each 14 6
- 16in. x 10in. x 2 1/2in., each 14 6

★ ★ ★ ★ ★ ★ ★ ★ ★ ★ ★ ★ ★ ★ ★ ★

220v. Input 6.5 volt 1.5 amp. and 3v. 2 amp., each ... 14 3

## 3-VALVE T.R.F. KIT



- Easy to Build.
- Valves 6J7, 6K7, 6V6GT plus rectifier.
- Walnut cabinet.

Full instructions, point to point wiring diagram, Circuit diagram, and full shopping list 1/-, All components may be purchased separately.

**£5.10.0**

WHEN ORDERING PLEASE QUOTE "DEPT. P.W."

**ALPHA**  
RADIO SUPPLY CO.  
5/6 VINCES CHAMBERS  
VICTORIA SQUARE  
LEEDS 1.

TERMS: Cash with order or C.O.D. Postage and Packing charges extra, as follows: Orders value 10/- add 1/-; 20/- add 1/6; 40/- add 2/-; £5 add 3/- unless otherwise stated. Minimum C.O.D. fee and postage 3/-. All single valves postage 6d.  
**MAIL ORDER ONLY**

# R.S.C. BATTERY CHARGING EQUIPMENT.

All for A.C. MAINS 200-250 v., 50 c/s. Guaranteed 12 months.

## ASSEMBLED CHARGERS

- 6 v. 1 amp. .... 19/9
  - 6 v. or 12 v. 1 amp. .... 25/9
  - 6 v. 2 amps. .... 29/9
  - 6 v. or 12 v. 2 amps. .... 38/9
  - 6 v. or 12 v. 4 amps. .... 56/9
- Above ready for use. Carr. 2/9.  
With mains and output leads.

## HEAVY DUTY KIT

12 v. 30 amp. Suitable for Garage or firm with a number of vehicles. Mains input 200/250 v. 50 c/s. Outputs 12 v. 15 amp. twice. Consists of Mains Trans. 2 Metal Rectifiers, 2 Meters, 4 Fuses, 4 Terminals, 2 Rheostats and circuit. Only 9 gns., carr. 15/-.

## BATTERY CHARGER KITS

Consisting of Mains Transformer, F.W. Bridge, Metal Rectifier, well ventilated steel case, Fuses, Fuse-holders, Grommets, panels and circuit. Carr. 2/6 extra.

- 6 v. or 12 v. 1 amp. .... 22/9
- 6 v. 2 amps. .... 25/9
- 6 v. or 12 v. 2 amps. .... 31/6
- 6 v. or 12 v. 4 amps. .... 49/9

## BATTERY CHARGER KIT

Consisting of F.W. Bridge Rectifier 6/12 v. 5 a. Mains Trans. 0-9-15 v. 6 a. output and variable charge rheostat with knob. Only 45/9.

## ASSEMBLED CHARGER

6 v. or 12 v. 2 amps. Fitted Ammeter and selector plug for 6 v. or 12 v. Louvred metal case, finished attractive hammer blue. Ready for use. With main's and output leads; 1 Double Fused. Only Carr. 3/6. **46/9**



Assembled 6 v. or 12 v. 4 amps. Fitted Ammeter and variable charge selector. Also selector plug for 6 v. or 12 v. charging. Double fused. Well ventilated steel case with blue hammer finish. **69/6**  
Ready for use with mains and output leads. Carr. 3/6

# R.S.C. MAINS TRANSFORMERS (GUARANTEED)

Interleaved and impregnated. Primaries 200-230-250 v. 50 c/s. Screened. **TOP SHROUDED DROP THROUGH**

- 250-0-250 v. 70 mA. 6.3 v. 2.5 a. .... 13/9
- 250-0-250 v. 70 mA. 6.3 v. 2.5 a. 5v. 2a. .... 18/9
- 300-0-300 v. 70 mA. 6.3 v. 2.5 a. .... 16/8
- 350-0-350 v. 100 mA. 6.3 v. 2.5 a. 5v. 2a. .... 18/9
- 350-0-250 v. 100 mA. 6.3 v. 4 a. 5 v. 3 a. 22/9
- 300-0-300 v. 100 mA. 6.3 v. 4 a. 5 v. 3 a. 22/9
- 350-0-350 v. 100 mA. 6.3 v. 4 a. 5 v. 3 a. 22/9
- 350-0-350 v. 100 mA. 6.3 v. 4 a. C.T. 0-4-5 v. 3 a. .... 23/9
- 350-0-350 v. 150 mA. 6.3 v. 4 a. 5 v. 3 a. .... 29/9

## FULLY SHROUDED UPRIGHT

- 250-0-250 v. 60 mA. 6.3 v. 2 a. 5 v. 2 a. Midget type 21-3in. .... 17/6
- 350-0-350 v. 70 mA. 6.3 v. 2 a. 5 v. 2 a. .... 19/9
- 250-0-250 v. 100 mA. 6.3 v. 4 v. 4 a. C.T. 0-4-5 v. 3 a. .... 26/9
- 250-0-250 v. 100 mA. 6.3 v. 6 a. 5 v. 3 a. for R135 conversion .... 31/-
- 300-0-300 v. 100 mA. 6.3 v. 4 v. 4 a. C.T. 0-4-5 v. 3 a. .... 26/9
- 350-0-350 v. 100 mA. 6.3 v. 4 a. 5 v. 3 a. 23/9
- 350-0-350 v. 100 mA. 6.3 v. 4 v. 4 a. C.T. 0-4-5 v. 3 a. .... 27/9
- 350-0-350 v. 150 mA. 6.3 v. 4 a. 5 v. 3 a. 33/9
- 350-0-350 v. 150 mA. 6.3 v. 2 a. 6.3 v. 2 a. 5 v. 3 a. .... 35/9
- 425-0-425 v. 200 mA. 6.3 v. 4 a. C.T. 6.3 v. 4 a. C.T. 5 v. 3 a. Suitable Williamson Amplifier, etc. .... 49/9
- 450-0-450 v. 250 mA. 6.3 v. 6 a. 6.3 v. 6 a. 5 v. 3 a. .... 69/9

## E.H.T. TRANSFORMERS

2,500 v. 5 mA. 2-0-2 v. 1.1 a. 2-0-2 v. 1.1a for VCR97, VCR517, etc. .... 36/6

## ELIMINATOR TRANSFORMERS

Primaries 200-250 v. 50 c/s. .... 14/9  
120 v. 40 mA. 5-0-5 v. 1 a. .... 15/9  
90 v. 15 mA. 4-0-4 v. 500 mA. .... 9/9

## SMALL POTTED MAINS TRANSF.

Removed from New Ex-Govt. units. Primary 200-230-250 v. Secs. 250-0-250 v. 60 mA. 6.3 v. 2 a. 5 v. 2 a. Size 3 1/4 x 4 1/2 in. .... **11/9**

## FILAMENT TRANSFORMERS

All with 200-250 v. 50 c/s primaries 6.3 v. 1.5 a. 5 9; 6.3 v. 2 a. 7/6; 10-4-6.3 v. 2 a. 7/9; 12 v. 1 a. 7/11; 6.3 v. 3 a. 8/11; 6.3 v. 6 a. 17/6; 12 v. 3 a. or 24 v. 1.5 a. 17/6.

## CHARGER TRANSFORMERS

All with 200-230-250 v. 50 c/s Primaries: 0-9-15 v. 1 a. 11/9; 0-9-15 v. 3 a. 16/9; 0-3-5-9-17 v. 3 a. 17/9; 0-3-5-9-17.5 v. 4 a. 18/9; 0-9-15 v. 5 a. 19/9; 0-9-15 v. 6 a. 22/9.

## SMOOTHING CHOKES

- 250 mA 5 H 100 ohms .... 11/9
- 150 mA 7-10-250 ohms .... 11/9
- 100 mA 10 H 200 ohms .... 8/9
- 80 mA 10 H 350 ohms .... 5/6
- 60 mA 10 H 400 ohms .... 4/11

## OUTPUT TRANSFORMERS

Midget Battery Pentode 66; 1 for 384, etc. .... 3/9  
Small Pentode, 5,000  $\Omega$  to 3  $\Omega$  .... 3/9  
Standard Pentode, 5,000  $\Omega$  to 3  $\Omega$  .... 4/9  
Standard Pentode, 10,000  $\Omega$  to 3  $\Omega$  .... 4/9  
Multi-ratio 40 mA. 30 : 1, 45 : 1, 60 : 1, 90 : 1, Class B Push-Pull .... 5/6  
Push-Pull 10-12 watts 6V6 to 3  $\Omega$  or 15  $\Omega$  .... 15/9  
Push-Pull 10-12 watts to match 6V6 to 3-5-9 or 15  $\Omega$  .... 16/9  
Push-Pull 15-18 watts. 6L6, KT66 .... 22/9  
Push-Pull 20 watts, sectionally wound 6L6, KT66, etc. to 3 or 15  $\Omega$  47/9  
Williamson type exact to spec. .... 85/-

## SILVER MIC A CONDENSERS.

5, 10, 15, 20, 25, 30, 35, 40, 50, 100, 120, 150, 200, 230, 300, 400, 500, 1,000 (0.01 mfd.), 2,000 pfd. (.002 mfd.), 6d. each 3/9 doz. One type.

## H.T. ELIMINATOR AND TRUCKLE CHARGER KIT.

Input 230-250 v. A.C. Output 120 v. 40 mA. Fully smoothed and rectified supply to charge 2 v. accumulator. Price with louvred metal case and circuit, 29/6. Or ready for use, 8/9 extra.

# R.S.C. BATTERY TO MAINS CONVERSION UNITS

Type BM1. An all dry battery eliminator. Size 5 1/4 x 4 1/2 in. approx. Completely replaces batteries supplying 1.4 v. and 90 v. where A.C. mains 200-250 v. 50 c/s. is available. Suitable for all battery portable receivers requiring 1.4 v. and 90 v. This includes latest low consumption types. Complete kit with diagrams 39/9, or ready for use, 46/9.



Type BM2. Size 8 1/2 x 2 1/2 in. Supplies 120 v. 50 v. and 60 v., 40 mA. and 2 v. 0.4 to 10 amp. fully smoothed. Thereby completely replacing both H.T. batteries and L.T. 2 v. accumulator. When connected to A.C. mains supply 200-250 v. 50 c/s. **SUITABLE FOR ALL BATTERY RECEIVERS normally using 2 v. Accumulator.** Complete kit of parts with diagrams and instructions 49/9, or ready for use 59/6.

**SPECIAL OFFERS** 8-8 mfd. 450 v. small can electrolytics in lots of six. 1/6 ea. Small .0005 mfd. 2 Gangs, 4.9ea.

**EXTENSION SPEAKERS.** Ready for use in walnut veneered cabinet. 6in. 2-3 ohms. 29/6. 8in. 2-3 ohms. 35/9. vel y limited number.



**T.V. CABINETS.** Leading manufacturers surplus. Attractive design. Walnut veneered. Type for 12in. Tube, 29/6. Type with doors for 15, 16, or 17in. Tube, £3-19-6. Carr. 7/6.

**LANE TAPE TABLE.** Mark VI. Brand New. Only 14 Gns., plus 10/- Carr.

## MANUFACTURERS' SURPLUS MAINS TRANSFORMERS.

Primaries 250-250 v. 50 c/s. Fully shrouded upright mounting 425-0-425 v. 150 mA. 6.3 v. 3 a. 5 v. 3 a. 29/11. Clamped type 250-0-250 v. 70 mA. 6.3 v. 2.5 a. 9/9, post 2/- Wearite 325-0-325 v. 100 mA. 6.3 v. 2.5 a. 5 v. 2 a. 19/9.

**EX-GOVT. TRANSF.** 230/250 v. 50 c/s. 8.8 v. 4 a. 9/9; 460 v. 200 mA. 6.3 v. 5 a. 25/9; 500-0-500 v. 150 mA. 4 v. 3 a. 9/9; 0-16-18-20 v. 35 a. 69/6. carr. 7/6.

## EX-GOVT. SMOOTHING CHOKES

- 250 mA. 10 H 50 ohms .... 14/9
- 150 mA. 10 H 100 ohms .... 11/9
- 150 mA. 6-10 H 150 ohms Trop. .... 6/11
- 100 mA. 10 H 150 ohms Tropicalised .... 3/11
- L.T. type 1 amp. 2 ohms .... 2/9

## EX-GOVT. METAL BLOCK (PAPER) CONDENSERS

4 mfd. 500 v. 2/9; 8-8 mfd. 500 v. 6/9; 8 mfd. 500 v. 5/9; 10 mfd. 500 v. 6/9; 15 mfd. 500 v. 6/9; 4 mfd. 400 v. plus 2 mfd. 250 v. 1/11.

## EX-GOVT. E.H.T. SMOOTHERS

5 mfd. 2,500 v. Blocks. 3/9; 1 mfd. plus 1 mfd. 8,000 v. 9/6.

## EX-GOVT. ELECTROLYTICS.

Removed from unused equipment. 8-16 mfd. 550 v. 1/3; 16-16 mfd. 350 v. 1/3; 1,000 mfd. 6 v. with clip, 1/9; 50 mfd. 50 v. with clip. 9/9.

**CONTROL PANEL** with six position, 3 wafer Yaxley switch, pointer knob. 2 S.P.S.T. switches, various plugs and sockets. Only 1/6.

## EX-GOVT. VALVES (NEW)

1T4	7/9	EF80	8/9	EBC33	7/9
1R5	7/9	EF29	5/6	EB1	7/9
1S5	7/9	6XGT6	6/9	EB91	9/9
3S4	8/9	6XST6	7/9	ECC83	9/9
5U4G	9/9	6L6G	11/9	EF36	3/9
5Y3G	8/11	807	7/9	EL32	3/9
5Z4G	9/9	12A6	7/9	EL81	5/9
6X7G	5/9	15D2	4/9	KT44	8/9
6K8G	9/9	25Z4G	9/9	KT66	11/9
6SN7GT	8/9	35Z4G	8/9	SP41	1/11
6S7GT	6/9	6L6G	11/9	SP61	2/9
6FGG	7/9	HM4	4/9	PX25	14/9

## EX-GOVT. UNIT 4RFL Brand new, cartoned.

Complete with 14 valves, including 5Z4, E.H.T. rectifier, Mains Trans. Choke, etc. Only 29/9, carr. 7/6.

## ELECTROLYTICS (current production) NOT Ex-Govt.

Tubular Types	Can Types
8 $\mu$ F 450 v. .... 1/9	8 mfd. 600 v. 2/11
8 mfd. 500 v. 2/6	16 mfd. 500 v. 3/9
16 $\mu$ F 350 v. .... 2/3	16 mfd. 500 v. 1/11
16 $\mu$ F 450 v. .... 2/9	16 $\mu$ F 450 v. 2/9
16 $\mu$ F 500 v. .... 3/9	32 $\mu$ F 350 v. .... 2/11
32 $\mu$ F 350 v. .... 3/9	32 mfd. 450 v. 4/9
32 $\mu$ F 500 v. .... 5/9	64 mfd. 450 v. 3/11
25 $\mu$ F 25 v. .... 1/3	100 mfd. 450 v. 4/9
50 $\mu$ F 12 v. .... 1/3	8-8 $\mu$ F 450 v. .... 2/9
50 mfd. 25 v. .... 1/6	8-16 $\mu$ F 450 v. 2/11
50 $\mu$ F 50 v. .... 1/6	16-16 $\mu$ F 450 v. 3/11
100 mfd. 12 v. 1/9	16-32 $\mu$ F 350 v. 4/9
100 mfd. 25 v. 2/3	32-32 $\mu$ F 450 v. 5/9
	60-100 mfd. .... 6/11
	64-120 mfd. 35 $\mu$ F 7/9
	100-200 mfd. .... 6/9

Many others in stock.

**HUNTS MOLDSAL CONDENSERS.** .005 mfd. 400 v., .01 mfd. 400 v., .04 mfd. 500 v., 5/6 doz. (one type); 1 mfd. 500 v. 9d. ea.; .25 mfd. 500 v. 1/3; .5 mfd. 500 v. 1/8 ea.



**R.S.C. A8 ULTRA LINEAR 12 WATT AMPLIFIER**

NEW 1956 Model High-Fidelity Push-Pull Amplifier with "Built-in" Tone Control, Pre-amp stages, High sensitivity. Includes 5 valves (807 outputs). High Quality sectionally wound output transformer, specially designed for Ultra Linear operation, and reliable small condensers of current manufacture. **INDIVIDUAL CONTROLS FOR BASS AND TREBLE "Lift" and "Cut."** Frequency response  $\pm 3$  db. 30-30,000 c/c. Six negative feedback loops. Hum level 71 db. down. **ONLY 70 millivolts INPUT** required for **FULL OUTPUT**. Suitable for use with all makes and types of Pick-ups and practically all microphones. Comparable with the very best designs. **FOR STANDARD or LONG - PLAYING RECORDS. FOR MUSICAL INSTRUMENTS, such as STRING BASS, GUITARS, etc. OUTPUT SOCKET** with plug provides 300 v. 20 mA. and 6.3 v. 1.5 a. For supply of a **RADIO FEEDER UNIT**. Size approx. 12.9-7in. For A.C. Mains 200-250 v. 50 c/c's. Outputs for 3 and 15 ohm speakers. Chassis is fully punched. Full instructions and point-to-point wiring diagrams supplied. Unapproachable value at **£7/15/-**, or factory built 45/- extra. Carriage 10/-

**£7-15-0**

If required Ioured metal cover with 2 **FOUR STAGE RADIO FEEDER UNIT**. Design of a High-Fidelity Tuner Unit T.R.F. L. & M. Wave. Full decoupling. Only 250-400 v. 10-15 mA. H.T. required from main amplifier. Three v. valve and low distortion Germanium diode detector. Flat-topped response characteristic. Loaded H.F. coils. Two variable-Mu controlled H.F. stages. 3-Gang condenser tuning. Detailed wiring diagrams, parts lists and illustration, 2/6. Total building cost, **£3/15/-**.

**GARRARD 3-SPEED AUTO-CHANGER RC10**. Current Model. Brand new, cartoned. Provision for recording 10 records. Fitted with fidelity turnover pick-up head with dual sapphire point stylus for Standard or Long-playing records. Very limited number at only **£8/17/6**. Carr. 5/6.

**DECCA RECORD PLAYING DESK** with High-Fidelity crystal pick-up. Turnover head has dual sapphire point stylus for Standard or Long-playing records. 33 and 78 r.p.m. For mains supply 200-250 v. 50 c/c's. A.C. Brand new, cartoned. Only **£6/17/6**. Carr. 5/6.

**DEFIANT RECORD PLAYING UNITS** Turntable for standard 10in. and 12in. 70 r.p.m. records (fitted auto-stop) and high impedance magnetic pick-up, mounted in attractive polished walnut finish drawer-type cabinet. Exceptional value at **£5/17/6**, plus 7/6 carr.

**B.S.R. MONARCH 3-SPEED MIXER AUTO-CHANGER**. For standard 200-250 v. 50 c/s mains. Ten changes on all 3 speeds. Plays Ten mixed 7in., 10in. and 12in. records. Separate sapphire stylus for L.P. and 78 r.p.m. High-fidelity type crystal Pick-up. Minimum baseboard size needed 14in. x 12in. x 5 1/2in. High-Brand new, cartoned, at **£7/15/-**, carr. 3/6.

**WALNUT VENERED CABINETS**. (Ex. leading manufacturers Table Radio-gram Cabinets) designed for above B.S.R. Changers. Brand new, cartoned. Only **£3/19/6**, carr. 7/6.

**3-4 WATT QUALITY AMPLIFIER**. Designed for use with B.S.R. Auto-changer and above cabinets. Fitted separate Bass and Treble controls. Vol. Control and m.f. switch. Latest type B.V.A. valves used. For 200-250v. A.C. mains. Ready for use. Only **£3/19/6**, carr. 3/6.

**ELLIPTICAL P.M. SPEAKER**. 7 x 3 1/2in. Goodmans. Suitable for above. 17x.

**VOLUME CONTROLS** with long (4in. diam.) spindle and valves, lever switch, 2 1/2; with S.P. switch. 3 1/2; with D.P. switch. 4/6.

Terms : C.W.O. or C.O.D. **NO C.O.D.** under £1. Post 1/9 extra under £2. Open 9 to 5.30; Sats. until 1 p.m. Catalogue 6d., Trade List 5d. S.A. E. with all enquiries.

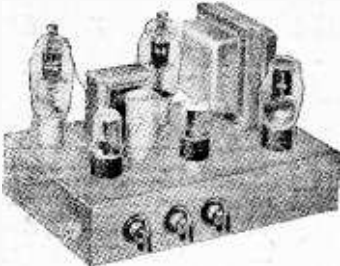

carrying handles can be supplied for 17/6. Additional input socket with associated Vol. Control so that two different inputs such as Gram and "Mike" or Tape and Radio can be mixed, can be provided for 13/- extra. **H.P. TERMS** on assembled two input model. **DEPOSIT 25/6** and nine monthly payments 22/4. **HIGH - FIDELITY MICROPHONES** and **SPEAKERS** in stock. Keep cash prices or H.P. terms if supplied with amplifier.

**R.S.C. 4.5 WATT A5 HIGH-GAIN AMPLIFIER**

A highly sensitive 4-valve quality amplifier for use with the home s.n.a.i. club, etc. Only 50 millivolts input is required for full output so that it is suitable for use with the latest high-fidelity pick-up heads, in addition to all other types of pick-ups and practically all mikes. Separate Bass and Treble Controls are provided. These give full long-playing record equalisation. Hum level is negligible being 71 db. down. 15 db. of negative feedback is used. H.T. of 300 v. 25 mA. and L.T. of 6.3 v. 1.5 a. is available for the supply of a **Radio Feeder Unit**, or **Tape Deck preamplifier**. For A.C. mains input of 200-250 v. 50 c/c's. Chassis is not alive. Kit is complete in every detail and includes fully punched chassis (with baseplate) with green crackle finish, and point-to-point wiring diagrams and instructions. Exceptional value at only **£4/15/-**, or assembled ready for use 25/- extra, plus 3/6 carr.



**R.S.C. TAI HIGH QUALITY TAPE DECK AMPLIFIER**. For ALL Tape Decks with High Impedance. Playback and Erase Heads, such as Lane, Truvox etc. Adjustment Ready for type of deck made by Use ONLY alteration of a resistor. For A.C. Mains 230-250 v. 50 c/c's. Positive compensated identification of recording level by Magic Eye. Recording facilities for 15, 71 or 31in. per sec. Automatic equalisation at the turn of a knob. Linear frequency response of  $\pm 3$  db., 50-11,000 c.p.s. Negative feedback equalisation. Minimum microphony and hum. High output with completely effective erasure and distortionless reproduction. Sensitivity is 15 millivolts so that any kind of crystal microphone is suitable. Only 2 millivolts minimum output required from Recording head. Provision is made for feeding a P.A. amplifier. Unit can also be used as a gram-amplifier requiring input of 0.75v. R.M.S. Carriage 7/6. Illustrated leaflet 6d.

**11 GNS.**

**PICK-UPS**. Collaro high-fidelity low impedance magnetic type, with matching transformer. Only 3/6. Brand New.

**R.S.C. 30 WATT ULTRA LINEAR HIGH-FIDELITY AMPLIFIER A6**

A highly sensitive Push-Pull, high output unit with self-contained Pre-amp, Tone Control Stages. Certified performance figures compare equally with most expensive amplifiers available. Hum level 70 db. down. Frequency response  $\pm 3$  db. 30-30,000 c/c's. A specially designed sectionally wound ultra linear output transformer is used with 807 output valves. All components are chosen for reliability. Six valves are used, and separate Bass and Treble controls. Minimum input required for full output is only 30 millivolts so that **ANY KIND OF MICROPHONE OR PICK-UP IS SUITABLE**. The unit is designed for **CLUBS, SCHOOLS, THEATRES, DANCE HALLS or OUTDOOR FUNCTIONS**, etc. For use with **Electronic ORGAN, GUITAR, STRING BASS**, etc. For standard or long-playing records. **OUTPUT SOCKET PROVIDED** for L.T. and H.T. for a **RADIO FEEDER UNIT**. Amplifier operates on 200-250 v. 50 c/c's. A.C. Mains and has outputs for 3 and 15 ohm speakers. Complete kit of parts with wiring diagrams and instructions. If required cover as for A8 can be supplied for 17/6. An extra input with associated vol. control so that two separate inputs such as Gram, and Mike can be mixed, can be provided for 13/- extra. The amplifier can be supplied, factory built with 12 months' guarantee for 50/- extra. **H.P. TERMS** for assembled two input model: **DEPOSIT 25/6** and 12 monthly payments of 21/-.

**9 GNS.**

**P.M. SPEAKERS**. All 2-3 ohms, 5in. Goodmans, 15/9. 6in. Plessey, 16/9. 8in. Plessey, 16/9. 8in. Rola, 19/9. 10in. Plessey Heavy duty, 26/9. 10in. R.A., 26/9. 12in. Plessey, 29/11. 10in. W.B. "Stentorian" 3 or 15 ohms type HF1012 10 watts high-fidelity type. Highly recommended for use with any of our amplifiers, **£4/10/0**.

**PLESSEY DUAL CONCENTRIC 12in. 15 ohm HIGH FIDELITY SPEAKER** with built-in tweeter (completely separate elliptical speaker with choke, condensers, etc.) providing extraordinarily realistic reproduction when used with our A8 or similar amplifier. Rated 10 watts. Price complete, only **£5/17/6**.

**M.E. SPEAKERS** 2-3 ohms, 8in. R.A. Field, 600 ohms, 11/9. 10in. R.A. Field, 1,000 ohms, 25/9. 10in. R.A. Field, 1,500 ohms, 23/9.

**COAXIAL CABLE** 75 ohms, 4in. 8d. yard. Twin Screened Feeder, 11d. yard.

**SELENIUM RECTIFIERS**

F.W. Bridge Type	L.T. Types H.W.
6/12 v. 1 a. 5/9	6-12v. 1a. H.W. 2/9
6/12 v. 2 a. 8/9	H.T. Types H.W.
6/12 v. 3 a. 12/9	150 v. 40 mA. 3/9
6/12 v. 4 a. 16/9	250 v. 50 mA. 5/9
6/12 v. 4 a. 19/9	250 v. 80 mA. 7/9
6/12 v. 10 a. 25/9	250 v. 150 mA. 9/9
	300 v. 250 mA. 12/9

**R.S.C. 3-4 WATT A7 HIGH-GAIN AMPLIFIER**

For 230-250 v. 50 c/c's. Mains input. Appearance and Specification with exception of output wattage, as A5. Complete Kit with diagrams, **£3/15/-**. Assembled 22/6 extra. Carr. 3/6.

**THE SKYFOUR T.R.F. RECEIVER** A design of a 3-valve 200-250 v. A.C. Mains receiver with selenium rectifier. It consists of a variable-Mu high-gain H.F. stage followed by a low distortion mode bend detector. Power Pentode output is used. Valve line up being 6K7, SP61, 6FG. Selectivity and quality are well up to standard, and simplicity of construction is a special feature. Point-to-point wiring diagrams, instructions, and parts list, 1/9. This receiver can be built for a maximum of **£4/19/6** including attractive Brown or Cream Bakelite or Walnut veneered wood cabinet 12 x 6 1/2 x 5 1/2 in. £2. 2/9 extra under £5. S.A. E. with all enquiries.

**(LEEDS) LTD.**



UNDOUBTEDLY THE BEST VALUE YET OFFERED

# Stern's "fidelity" Tape Recorder

ASSEMBLED & READY FOR USE **£43**

(Plus £11.0.0 Carr. and Insurance. £1 is refunded when packing case is returned to us.)  
 Terms £21.10.0 deposit and 12 monthly payments of £1.19.10 or £11.0.0 deposit and 9 months of £3.18.3

**!! HOME CONSTRUCTORS !!**  
**— BUILD IT YOURSELF FOR £40**

The Truvox Tape Deck and the Quality Amplifier are supplied tested and ready for use. The actual assembly of the Recorder is simple and only involves a few connections (a connection chart is supplied for this purpose). The items illustrated and described form the complete equipment and each are available for sale separately.

**MODEL TR/F QUALITY AMPLIFIER**

This amplifier has been expressly designed to meet the requirements of enthusiasts for fidelity reproduction, and in particular to CORRECTLY operate the above TRUVOX DECK. It is supplied complete with a matched Electrical 3-ohm P.M. Speaker. It incorporates an efficient Tone Control arrangement and has a Magic Eye Level Indicator (Operative on Record). It can also be used as a general purpose Amplifier for high quality reproduction of gramophone records direct from a Gram Unit.  
 Price £14.14.0.

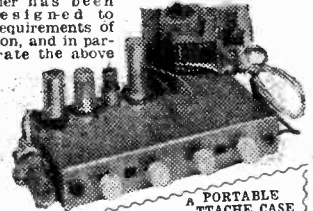

A PORTABLE TTACHE CASE  
 Neat, compact and attractively finished. It contains concealed pockets for Mike, Mains Lead and rest of tape.

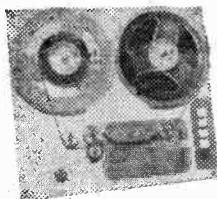

**TRUVOX TAPE DECK MODEL Mk. III/TR7/u**

This is Truvox's new "small" design being only 14in. x 13in. The whole instrument is built to close engineering limits resulting in the minimum of "wow" and "flutter" values. It will play the NEW PRE-RECORDED TAPES and takes all standard tapes up to 1,200ft. £23.2.0.

SEND S.A.E. FOR DESCRIPTIVE LEAFLET INCLUDING PRICE DETAILS & H.P. TERMS

**SCOTSBOY MAGNETIC RECORDING TAPE**

Supplied complete with a 1,200ft. reel of Scotsboy Tape. Price 35/-

**MODEL MIC33/1 ACOS CRYSTAL MICROPHONE**

A highly sensitive Mike which accurately matches the input arrangement of the Amplifier. Price £2.10.0.

## STERN RADIO LTD.

109 & 115, FLEET STREET, E.C.4

TEL.: FL Eet 5812-3-4.

- Germanium Diodes, 2/-; Silicon, 2/-; Pye Plug and Socket, 1/6;
- Belling Lee, 1/6; Socket, 1/-;
- Belling Lec 7-pin Plug and Socket, 2/6.
- Valve Holders, 1. Octal 6d.; M.O. 6d.; RK34 Type, 1/6; B7G, 1/-;
- B9A, 1/3; B9G, 9d.; 807 Type, 9d.; EA50 Type, 1/-.
- Ass'd Resistors. 1/4, 1/2, 1 watt, 12/6 per 100.
- Ass'd Condensers, Tubular and Mica, 15/- per 100.
- 200 K/c. Crystals, 8/-. London
- 230 v. A.C. Relays, 8/6.
- Packard Bell Amplifier, New in carton, complete with Handbook, 12/6 each.
- 16 Bank Switch, 8/6; G.P.O. 3,000 Type, Relay 6,000Ω, 8/6.
- U.S.A. Dinghy Tx Hand Generators, 15/-.
- Condensers. Elec., 450 volt D.C. Working 8 mfd., 2/6; 8+8 mfd., 3/-; 8+16 mfd., 4/-; 16+16, 4/6; 16 mfd., 3/9; 20 mfd., 3/-; 32+32 mfd., 6/-; 100 mfd., 8/6; 50 mfd., 50 volt or 25 mfd. 25 volt, 2/-.
- 1 mA. Meter Rectifiers, 4/6.
- 12 Ass'd Switches, 10/-. Rotary Type Yaxley, 1 pole, 11 way, 3/6; 4 pole, 3 way, 3/6; 1 pole, 11 way, 2 bank, 4/6.
- Jason F.M. Tuner Kit, complete, £7, with valves.

## VALVES

EF50	4/-	EA50	2/-	SP41	2/6
EF50(Syl)	6/3	D1	2/-	6J6	5/6
6AG7	9/-	6AC7	7/6	6C4	7/6
6SN7	9/-	6AM6	8/6	6V6	8/6
6SL7	9/-	6J5	5/-	EF39	7/6
6X5	7/6	6X4	7/6	EF37A	9/-
Pen46	5/6	EF54	5/-	EF36	4/6
Pen25	6/6	EC52	5/-	6SA7	7/6
Pen220	4/-	6SH7	8/-	EBC33	7/6
6SJ7	7/6	6J7	7/6	VT501	6/-
6SK7	4/6	6AG5	7/6	807	6/6
6H6	4/6	EB34	2/-	5U4G	8/6
EL50	9/-	VU39	8/6	105 30	7/6
SZ4	8/6	150/30	7/6	CV287	7/6
75/30	7/6	CV286	7/6	6BW6	11/-
R19	12/6	PW6	11/-	6N7	8/6
6BA6	9/6	P61	6/-	955	5/6
6K7	6/-	6K8	11/-	1S5	8/6
1T4	7/6	1S4	9/-	354	8/6
1A3	7/6	1625	7/6	AR8	7/6
1R5	8/6	PY81	10/-	UAF42	12/6
PL81	11/6	PY82	10/-	UCH42	10/6
PLR2	10/-	EY51	13/6	EL91	7/6
PLR3	11/6	ECL80	10/6	EZ40	10/6
ECC81	9/6	EF80	10/-	EZ80	10/6
ECC82	10/-	UY41	10/6	E280	10/6
ECC83	10/6	SP61	2/6	12A6	7/6

## U.S.A.

### TA12G TX

- Covers 4 bands, 300 K/c-600 K/c, 2-4 mc, 4-6 mc, 6-9 mc. Valve line-up? 807's, 4 12SK7's. With valves.
- Carr. **£4. 10. 0** Paid
- R.F. 24 Units (Less Valves), 7/6, post 2/-.
- Heater Transformers. 6.3 v. 1.5 amp. tapped. 2 and 4 volt, 7/6, post 1/6.
- Blower Unit. Powerful Blower. 230 volt, A.C., 50 cps. input, with Filter, £4. Extractor Fans, 9in. blade, 230 v. A.C. input, with wire guard, £4.
- Blower Unit. 24 volt input. Canadian make turbine impeller, £2.
- Klaxon Motor. 230 v. A.C., 50 cps., with Gear Box, final speed 60 r.p.m., £3/10/-.
- Transformer. All 230 v. A.C., 50 cps. input, 24 volt, 2 amp. (oil filled), 15/-; 14-20 volt, 20 amp., £3/10/-; 110 volt, 7 amp. auto., £3; 15 volt, 60 amp., £7/10/-; 275-0-275 v. 80 milliamps, 6.3 v. 0.9 a., 6.3 v. 2 amp., £1; 350 v., 250 C.T., 250 v. 350, 100 mA, 4 v. 2 a., 6.3 v. 4 a., £1; 3.5 v. 9 v., 17 v., 4 a., 24/-.

## VINERS

(MIDDLESBROUGH)

26, EAST ST., MIDDLESBROUGH

TEL.: MID 3418

# FULLY GUARANTEED

## RADIO & RADIOGRAM CHASSIS

Superhet. Chassis of Latest Design

General Specification applicable to all models.

**Mains:** A.C. 200/250 volts 50 cycles only.  
**Dial:** Suitably lit multi-coloured glass dial of the horizontal type.  
**Tuning Drive:** Slow motion by means of glass-cored Nylon cord.  
**A.V.C.:** Full provision of Automatic Volume Control Negative feed-back from output transformer secondary.  
**Sockets:** Sockets provided for Aerial, Earth, Gram, Pick-up and Extension Speaker. (Connections provided to Gram). Motor controlled by Chassis On/Off switch.  
**Inductances:** All inductances have an exceptionally high Q value.  
**Audio Section:** The Audio Section is designed for first rate reproduction on Radio and Gramophone. The tone controls have been given an extra wide range to embrace all types of recordings.

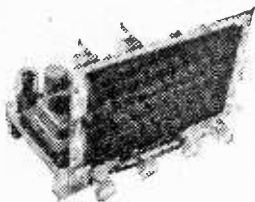

**CAT. NO. CR/A:** 6-valve Superhet 3 Wavebands ... .. **12 Gns.**

**CAT. NO. CR/B:** 7-valve Superhet with push-pull output, 3 Wavebands ... .. **16 Gns.**

Packing and Carriage on Models CR/A and CR/B, 12/6.

**CAT. NO. CR/AFM47:** 7-valve Superhet with F.M./V.H.F. Band (4 Wavebands) ... .. **23 1/2 Gns.**

**CAT. NO. CR/AFM49/PP:** 8-valve Superhet with F.M./V.H.F. Band (4 Wavebands), Push-pull output including 2 loudspeakers ... .. **26 Gns.**

Packing and Carriage on Models CR/AFM47 and CR/AFM49/PP, 12/6.

**\* built to the highest standard!**

**ALL FULLY GUARANTEED. GENEROUS EXTENDED CREDIT TERMS ON ORDERS EXCEEDING £15.**

### \* RADIOGRAM DROP-IN UNITS

These are fully guaranteed Radiograms consisting of Receiver Chassis, Auto Record Changer and matching Loudspeaker mounted on a lightweight frame with polished top panel. Needs only fixing inside suitable cabinet to become high quality Radiogram. Offered in two different models.

**CAT. NO. UNIT A/25:**  
 Chassis as type CR/A described elsewhere. 5 valve Superhet, 3 wavebands. **29 1/2 Gns.**

**CAT. NO. UNIT/AFM47:**  
 Chassis as type CR/AFM47 described elsewhere. 7 valve Superhet with F.M./V.H.F. Band. **37 1/2 Gns.**

Both units are fitted with latest BSR FOUR-Speed Auto Changer. Packing and Carriage, 20/-.  
**HIGH QUALITY BUREAU TYPE CABINET TO SUIT EITHER UNIT, 15 Gns.**

### \* MULTI-SPEED AUTOMATIC RECORD CHANGERS

All automatic Record Changers are of the latest type and unused.

**CAT. NO. RC/A:** This is the latest multi-speed changer incorporating 16 P.P.M. for "talking books," and arrangement for manual control. Fitted with high fidelity H.G.P.-27 Crystal Turn-over Pick-up Head. A.C. mains 200,250 volts. 50 cycles only.

**PRICE: CASH ONLY.** Packing and Carr.—12/6. **£9-15-0**

**CAT. NO. RC/B:** Latest GARRARD PCS model, fitted with GC2 Crystal Turn-over Pick-up Head. A.C. 200/250 volts 50 cycles.

**PRICE: CASH ONLY.** Packing and Carr.—12/6. **£13-0-0**

### \* PORTABLE TAPE RECORDER

**Cat. No. TR/A**  
 A superb High-Fidelity instrument incorporating the latest TRUVOX Tape Deck. In a beautifully fitted morocro-grained carrying case, this Tape Recorder is the very finest of its class, regardless of price.

**TAPE DECK:** TRUVOX model TR7U. Twin track with B.S.S. sense of recording. Two speeds, 7 1/2 in. (one hour for 1,200ft. reel), and 3 1/2 in. (2 hours for 1,200ft. reel). Full press-button control. Fast forward and rewind. Electro-magnetic braking. **44 Gns.**

**Packing and Carr.:** Payable in advance with order—25/-.

### \* PORTABLE TAPE RECORDER (KIT FORM)

**Cat. No. TR/A/KIT.**  
 A complete kit consisting of—  
 FULLY FITTED CARRYING CASE  
 TAPE DECK—TRUVOX TR7U  
 TAPE RECORDER AMPLIFIER  
 MICROPHONE—ACOS 23-1  
 SPEAKER—7in. x 4in. Electrical  
 MAGNETIC TAPE REEL

To the same specifications and similar to those used in the Portable Tape Recorder (Cat. No. TR/A), this complete kit offers the home-builder all that is required to construct a portable Tape Recorder of the finest quality. **42 Gns.**

**Packing and Carriage:** Payable in advance with order—25/-.

### \* F.M./V.H.F. TUNERS

**CAT. NO. FMT/A**  
 An F.M./V.H.F. Tuner Unit with automatic Magic Eye Tuning, fitted in a high grade dark Walnut cabinet. Adaptor is self-powered and completely self contained.

**CIRCUIT DETAILS:** 8-1X Valves and 10 Tuned Circuits for maximum sensitivity and best signal to noise ratio. **16 1/2 Gns.**

Packing and Carriage, 12/6.

**CAT. NO. FMT/B**  
 An F.M./V.H.F. Tuner Unit in chassis form, suitable for building into existing Radiograms or Radio Receivers. Adaptor is self-powered. Socket for additional Magic Eye filament is provided in the Chassis. **£13-15-0**

Packing and Carriage, 12/6.

### \* CABINET

**CAT. NO. CAB/02**  
 A well designed Bureau type cabinet in a medium size. Veneered in a highly figured Walnut. Outside dimensions, length 29 1/2 in., depth 16 in., height 32 in. Sloping control panel on right hand side approx. 13 in. x 10 1/2 in. Removable baseboard on right hand side approx. 13 1/2 in. x 13 in. Large record compartment located inside the cabinet above gram motor. **CASH Packing and ONLY 12 Gns.** Carriage, 20/-

### \* BUREAU CABINET



**CAT. NO. CAB/03**

A magnificent Bureau Type Cabinet of the very highest quality in specially selected Walnut veneered

exterior. Light Sycamore interior with Rexine lining to match. Outside dimensions: length 34 in., depth 17 1/2 in., height 33 in. Sloping control panel on right-hand side approx. 16 in. x 10 1/2 in. Removable baseboard on right side approx. 13 1/2 in. x 15 in. Two full-sized felt lined compartments in the lower half. **16 1/2 Gns.**

**Packing and Carriage:** Payable in advance with order, 25/-.

**Dealers Supplied at Full Discounts**

All enquiries (excluding Northern Area) to:

Northern enquiries only (not Scotland & N. Ireland) to:

**DOMESTIC**

**DIRECT SALES LTD.**

90 JUDD ST., LONDON, W.C.1. TER. 9876

**MAYLIT LTD**

3 MARLBOROUGH RD., ALTRINCHAM, CHESHIRE

Telephone enquiries: ALTRINCHAM 4045

## THE ACOS MIC 36

The ACOS MIC 36 crystal microphone performs as well as it looks. It is omnidirectional, highly sensitive, and has a substantially flat response from 30 to 7,000 c/s. It retails at £3.3.0 without switch or £3.8.0 with one, and is widely chosen for tape and disc work, P.A. and amateur radio.



STAND



HAND



**acos** *always well ahead*

*ACOS devices are protected by patents, patent applications  
and registered designs in Great Britain and abroad.*

**GOSMOCORD LIMITED • ENFIELD • MIDDLESEX • Tel: ENfield 4022**

# PRACTICAL WIRELESS

EVERY MONTH

VOL. XXXII, No. 596, AUGUST, 1956

COMMENTS OF THE MONTH

EDITOR : F. J. CAMM

24th YEAR  
OF ISSUE

BY THE EDITOR

Editorial and Advertisement Offices :  
 "Practical Wireless," George Newnes, Ltd., Tower House, Southampton Street, Strand, W.C.2. Phone : Temple Bar 4833.  
 Telegrams : Newnes, Band, London.  
 Registered at the G.P.O. for transmission by Canadian Magazine Post.

## Tape Recording and the Law of Copyright

THE continued rise in the sale of tape recorders reflects the growth of this sideline to radio. The hobby now has its own Association, which runs its own exhibition, and we have also the Audio Fair which stages a show rather in competition with the British Sound Recording Association. Neither of these exhibitions can be considered as on a national scale, like the Radio Show at Earls Court. They are very small affairs, and at this stage it might be thought that there was no room for competition for what is, in relation to radio, a comparatively small though ever-expanding market. Sound recording could be an interesting branch of the Radio Show for we do not think that the industry is large enough to stage a large exhibition, nor do we think that the subject alone is worthy of an exhibition entirely devoted to it. There are far too many exhibitions as it is and indeed there are far too many Associations. There is not a great deal of variety in design nor sufficient diversity of interest to attract large numbers of the public to a separate exhibition. We suggest that the BSRA and the AF combine forces with the object of staging a separate exhibition within the larger Radio Show. The conventions could still be held at Earls Court and the exhibits would be brought to the notice of a much larger public with benefit to the industry.

A more serious aspect of this fascinating hobby concerns the involved question of copyright. According to the *Daily Mail*, to record one note, or word, from the radio or television broadcasts in this country is an infringement of the law, even if the recording is to be used only for private purposes. Some artists record their own programmes so that they can criticise and polish their technique. Yet even they, we are told, are committing an offence. On this point we beg to differ. We do not think that any judge would hold that a recording made for this purpose and for the private hearing of the person who made the original broadcast would be infringement of copyright. A law which cannot be enforced is a bad law and without conceding that a man who makes a recording for his own use of a radio or television programme is infringing copyright, we say that owners of tape recorders

will continue to make recordings which cannot be considered as "publication" within the meaning of the Copyright Act. An artist does not usually assign the copyright of his broadcast and an author or artist cannot infringe his own copyright. People do not buy tape recorders for the purpose of recording their own voices or those of their family or friends. If a man makes a recording for public performance, or for sale, that is a different matter. We do not agree that "a serious illegal practice has grown up as a result of the sale to the public of tape recording machines. Instead of buying records, people can now record their own music straight from the radio or television." Owners of these recorders do not store tape recordings. They erase them and use the tapes over and over again. Moreover, a recording on tape is only semi-permanent. Gramophone records are in an entirely different category. If these are played in public a licence must be purchased from Phonographic Performances, Ltd., which is a joint organisation representing all gramophone companies, formed 22 years ago to protect their interests. These licences last for a year, and such licences are regularly applied for by the BBC, I.T.V. as well as football clubs, hotels, pleasure boats and village halls. They collect well over £100,000 each year in licences and it is distributed amongst the recording companies and in turn they allocate 40 per cent. to the artists and musicians involved. We do not think that tape recordings or gramophone records should be classed in any category different from books, periodicals or newspapers. A publisher may sell one book to a library and it is read by hundreds of people and sales are thereby lost. One reader may hand a copy of this journal round to half a dozen of his friends. By no stretch of the imagination can this be considered as infringement of the copyright. The law of copyright is being pressed too far in connection with tape recording.

### THE RADIO SHOW

THIS year's radio show takes place at Earls Court from August 22nd to September 1st. Our Stand Number is 111, where all readers visiting the show will be welcome.—F. J. C.

# Round the World of Wireless



By "QUESTOR"

## Broadcast Receiving Licences

THE following statement shows the approximate number of Broadcast receiving licences in force at the end of April, 1956, in respect of wireless receiving stations situated within the various postal regions of England, Wales, Scotland and Northern Ireland. The numbers include licences issued to blind persons without payment.

Region	Total
London Postal ... ..	1,314,473
Home Counties ... ..	1,300,217
Midland ... ..	1,017,237
North Eastern ... ..	1,331,628
North Western ... ..	1,014,335
South Western ... ..	833,741
Wales and Border Counties ... ..	523,824
<b>Total England and Wales ... ..</b>	<b>7,335,455</b>
Scotland ... ..	942,065
Northern Ireland ... ..	206,282
<b>Total ... ..</b>	<b>8,483,802</b>

14,295,989 broadcast receiving licences, including 5,812,178 for television, and 294,901 for sets fitted in cars, were current in Great Britain and Northern Ireland at the end of April, 1956.

## New W.B. Directors

**WHITELEY ELECTRICAL RADIO CO., LTD.**, announce that Mr. H. W. Read, M.S.M.A., and Mr. R. T. Lakin, A.M.I.E.E., A.Brit.I.R.E., have been appointed to the board of directors. Mr. Read is well known as London manager of the company, while Mr. Lakin is the chief research technologist, and his special scientific contributions during the war years earned him the M.B.E. Both men have been with the company for more than 20 years; and have well-merited this recognition and distinction.

## Interesting Show Exhibit

ON Stand 10 of this year's Radio Show, Multicore Solders Limited will be staging a miniature factory exhibit in conjunction with A. J. Balcombe Ltd., showing how the new Ersin Multicore "Savbit" solder alloy is used in the wiring and soldering of Alba Midget Mains Radio Receivers.

Daily delivery of new parts to the Stand before the show opens each morning will coincide with the collection of complete receivers from the previous day.

More than 30,000 soldered joints will be made during the run of the Exhibition.

## New British Standards

THE following have just been issued: British Standard Code of Practice on the use of Electronic Valves (CP 1005: Part 3: 1956). British Standard for Fixed paper-dielectric capacitors for D.C. for use in telecommunication and allied electronic equipment (B.S. 2131: 1956).

Copies of the standards may be obtained from the British Standards Institution, Sales Branch: 2, Park Street, London, W.1. B.S. 2131 is 3s. 6d., and Part 3 of CP 1005 is 3s. 0d.

## Radio Show Announcers

THE Radio Industry Council have appointed two announcers for the 1956 Radio Show at Earls Court (August 22nd to September 1st). They are Miss Vera McKechnie, who has acted for the R.I.C. on previous occasions, and Miss Pauline Tooth, who has been a BBC hostess and interviewer in "In Town Tonight." A third announcer is still to be appointed.

The announcers will do their work in public view behind the glass windows of the R.I.C. control room.

Mr. Clive Rawes, BBC television presentation editor, is again acting as programme adviser to the R.I.C. for the Radio Show. His colleague, Mr. John Goss, seconded by the BBC, is again to be programme officer with Mr. Christopher Doll, also of the BBC, as assistant.

Mr. Goss and Mr. Doll will have over-all control of the two continuous television programmes on closed circuit and the sound programme on the public address system. The announcers will work under their instructions.

## Radiotelephone Service between Amman and London

**CABLE AND WIRELESS LTD.** announce that a direct radiotelephone service between Amman and London was opened on May 22nd.

The charge for a three-minute call is £3, with a report charge of 4s. 0d.

The service is available from 10.15 to 11.15 G.M.T. on weekdays.

## Radio Component Show, 1957

THE 14th annual British Radio Component Show, consisting of components, valves and test gear for the radio, gramophone, television, electronic and telecommunication industries, will be held in the Great Hall, Grosvenor House, Park Lane, London, W.1.

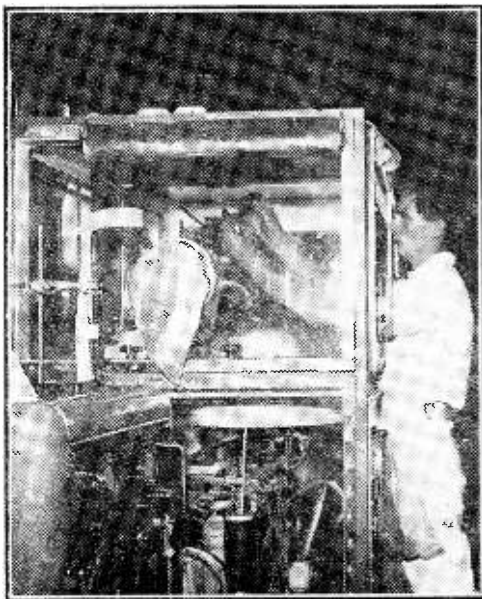

Mr. J. P. Evans, of Croydon, using a special glove-box technique in the Plutonium Metallurgy section of the Atomic Energy Research Establishment.

from April 9th to 11th, 1957, with a possible extension to April 12th. There will be a full day's preview on Monday, April 8th, for specially invited visitors instead of the half-day preview this year. Admission is by ticket only, obtainable from the Radio and Electronic Component Manufacturers' Federation, 21, Tothill Street, London, S.W.1.

**Another Radio Export Record**

**D**IRECT exports of British radio, television and electronic equipment are running at the rate of £36.5 million a year, as compared with £33 million last year, states the Radio Industry Council in issuing figures based on the Trade and Navigation Accounts.

The exports exceeded £3 million in each of the first three months of 1956, the total for the quarter being over £9.13 million, an increase of 17½ per cent. compared with 1955.

The quarter's exports and March exports by main groups are as follows:

	1st quarter 1956 £M.	March 1956
Radio and television receivers ...	1.05	£304,321
Sound - reproducing equipment ...	1.73	£596,133
Components and test gear ...	1.98	£681,352*
Valves and tubes ...	.71	£211,215
Transmitters, communications equipment, Navigation aids, etc. ...	3.66	£1,244,610
	<b>£9.13M.</b>	<b>£3,037,631</b>

\* Not including test gear.

**The E.M.I. College of Electronics**

**T**HE department of E.M.I. Institutes which provides full-time day courses giving comprehensive education in Radio and Electronic Engineering is, in future, to be known as the E.M.I. College of Electronics.

With the rapid and continuing expansion of the lecture rooms and laboratories of the College to meet the ever-growing national demand for highly trained scientists and technologists, the need has become apparent for a definitive title descriptive of the activities of this important branch of E.M.I. Institutes.

Today, over 200 students are attending the various full-time courses offered by the College, and in addition, a large number of qualified engineers and physicists are receiving part-time post-graduate training.

The standard courses in Electronic Engineering, Telecommunications, and Radio and Television Engineering are being augmented by special courses dealing with the advanced techniques of Automation, Electronic Process Control, and Digital and Analogue Computers.

Full details of courses, scholarships schemes and so on are available from: The E.M.I. College of Electronics, 10, Pembridge Sq., London, W.2.

Delivery of the F.M. Ranger will commence in the Autumn. The A.M. 50 kc/s and 25 kc/s Ranger is now in full production.

**Lower Egypt Telephone Network**

**A** FAR reaching project is announced by the Egyptian Republic Telephone and Telegraph Administration to establish a new communications network in Lower Egypt. The scheme involves the most up-to-date techniques for telephony over coaxial cables, with



*In Canada a new technique is being used to aid deaf mutes. The picture shows the first reaction to certain sounds, which enable the deaf mute to speak his first word. The hearing loss is measured on an audiometer.*

**F.M. for Export Market**

**P**YE TELECOMMUNICATIONS are now going into production with Frequency Modulated versions of the Pye Ranger Equipment for marine and certain export markets. The Pye Telecommunications F.M. equipment is designed to meet the American F.C.C. requirements as well as the Canadian Ministry of Transport and R.F.T.M.A. Specifications. It is also designed to meet the proposed new Maritime International Specification and the proposed new G.P.O. 50 kc/s specifications.

The F.M. Ranger Equipment will be for 60, 50 and 40 kc/s channel spacing. It will be marketed primarily for marine purposes in Canada and in those export markets where there is a substantial F.M. replacement market. Pye Telecommunications continue to recommend A.M. for all new installations.

provision for the future transmission of television programmes.

The total route of more than 400 kilometres in the Delta provides communication between Cairo, Benha, Tanta, Damanhour and Alexandria over a cable containing six coaxial tubes, with an extension from Tanta to Mansoura of a four-core coaxial cable.

Provision is made in the cables for a high quality, two-way music circuit by the inclusion of two screened pairs. In addition, the cable to be installed between Cairo and Alexandria will contain a number of carrier circuits suitable for use as Group to Zone Centre connections.

**Ministry of Supply Appointment**

**T**HE Ministry of Supply announce that Mr. C. P. Fogg has been appointed head of the Ground Radar Department, Radar Research Establishment, Malvern.

# MAKING A RADIO

## Alarm Clock

ADAPTING AN ALARM CLOCK FOR  
AUTOMATIC MAINS SWITCHING

By John Williams

**H**OW many people have coveted one of those expensive gadgets that switch on your wireless in the morning and provide you with a cup of tea as well! An old alarm clock can be made to do the first part at least, for the cost of a length of wire and a few odds and ends.

Almost any ordinary alarm-clock can be adapted; the details given are taken from a pre-war 4in.-dial type. A preliminary inspection will soon show what modification is required to the method described. The object is to make the clock close a switch at the time set.

The alarm mechanism is in two parts; the ringing device and the time control that releases it. The control, as shown in Fig. 1, is contained on one spindle, at one end of which is the time-setting knob (a) and at the other the indicator finger (j) on the clock face. The spindle is held firm by the spring clip (b) so that it can only be rotated by turning the knob (a).

The essential parts are fitted between the front plate of the clock mechanism (d) and the clock face itself (i). A long spring arm (e) is attached at one end to plate (d) and presses down on a 12-hour gear (f). This gear turns freely on the spindle but is fixed to a catch-wheel (g), a top view of which is shown in Fig. 2. This, in turn, presses down upon a recessed wheel (h) fixed on the spindle.

The gear (f) is synchronised so that when the clock is showing the time indicated by the small finger (j) the projection on the catch-wheel drops into the recess on wheel (h). The drop of the assembly (f) and (g) allows the end of the spring arm (e) to travel about 1/16in. This movement, which releases the ringing mechanism, is utilised to close two electrical contacts and so switch on the wireless.

The normal distance between the end (k) of the

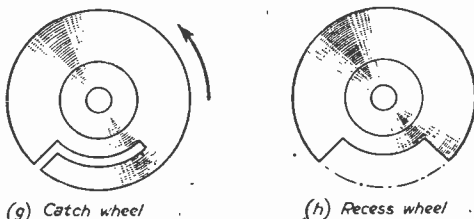
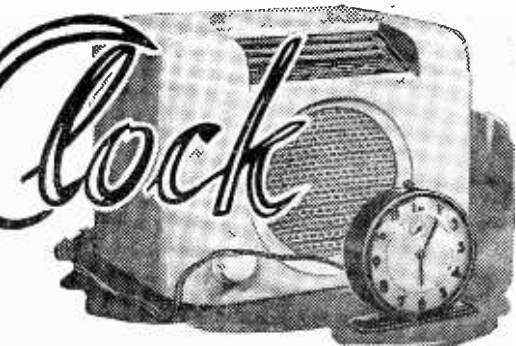

Fig. 2.—Details of the catch and recess wheels.



spring arm and the back of the clock face is about 3/16in. This is reduced to 1/4in. when the control operates. The two contacts must, therefore, be fixed so as to make a positive connection at this moment, as shown in Fig. 3.

First a piece of insulating material, such as celluloid, is glued firmly to the back of (i), directly beneath (k). To this is then glued a thin pad of heavy "silver-paper" (o), to which is connected an insulated wire. This can be prepared as follows.

Fold a strip of silver-paper just narrower than the celluloid and 1/4in. longer. To prevent the paper loosening, put a touch of glue between the folds. Bare 1/4in. of the wire and place it across the strip of silver-paper near the end, as in Fig. 4. Begin to roll the strip round the wire; then bring the wire back and wind it round itself to form a loop. Continue to roll the strip round the looped wire until only a 1/4in. square is left, which will form the contact. Pressure with pliers will consolidate the silver-paper round the wire before gluing.

Care must be taken to prevent glue coming between the paper and the wire or on the upper surface of the contact. The celluloid and contact should be so placed that the rolled edge securing the wire is quite clear of the end of the spring arm, and the flat square forming the contact exactly below it.

### Second Contact

The second contact, to be fixed to the spring arm, is made of a piece of firm india-rubber. It should be about 1/4in. square and just thin enough to fit between the spring arm and the first contact when the recess wheel is turned to coincide with the catch-wheel. A second wire (m) is attached to the rubber in the following way.

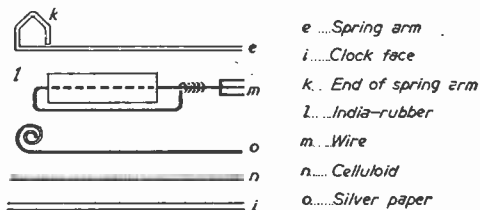

Fig. 3.—How the contacts are made up.



A pin-hole carefully pierced through the rubber from one edge to the other will enable the bared end of the wire to be passed through the rubber by continually twisting with the fingers as if it were a drill. The end of the wire is then turned back across one face of the rubber and twisted round itself to form a loop. The insulation should be eased over the twisted wires, if possible right up to the rubber. Care will be needed to see that the loop is not drawn so tight that

connection to the contact. The other should be left free, following the line of the spring arm so as not to impede its movement or tension. But it too, must be securely tied to prevent undue strain on the rubber mounting of the moving contact.

No part of the contacts or connections must be in a position to touch the frame of the clock, and as a precaution against any loosening of the contacts or other accident an earth wire must be connected to the frame. This can best be done at one of the bolts securing the outer cover to the frame. The earth wire should be twisted round the bolt under the cover so that it is trapped between it and the frame when the bolt is tightened.

The three wires are guided round the outside of the frame, keeping clear of all moving parts, to a position behind the figure six. There they should be led out through a hole drilled for the purpose in the outer cover of the clock. To prevent chafing it is advisable to protect the wires with a sleeve of thin card, rubber or tape where they leave the clock.

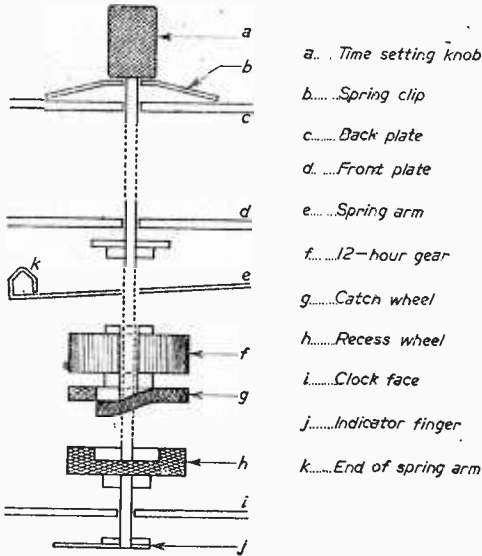

Fig. 1.—“Exploded” view of the clock assembly which is modified.

it cuts into the rubber. Careful pressure with pliers will square off the loop to the shape of the rubber, so that the wire sits firmly round it.

The rubber has then to be glued securely to the under-side of the spring arm, so that the exposed part of the loop faces the silver-paper contact below. The thickness of the wire should ensure that the contacts press tightly together when the switch closes. While the glue dries, the tension of the spring arm can be used to hold the contacts in place, increased if necessary by inserting a piece of cardboard between them. Each stage of the assembly should be glued and allowed to harden separately.

The wires must be tied rigidly to the clock frame some distance from the contacts. That from the static contact should be glued along its length to prevent movement and consequent strain on the

**Connections**

All that remains now is to make the necessary connections to the radio. The earth wire is connected to the mains earth, not to the wireless earth. The other wires are led to a two-way switch on the power input to the set, as shown in Fig. 5. For a battery set the connections would have to be made inside the case of the set, but otherwise they can be made wherever convenient. One arrangement would screw the switch to the back of the radio and place the clock somewhere close at hand, perhaps on top of the set.

When the two-way switch is in one position, the set would be under the control only of its own built-in switch. In the other, the power would be cut off until the time set for the contacts to close and complete the circuit. On retiring, therefore, one has only to switch off by means of the two-way switch instead of the set switch to ensure that the wireless is turned on again in the morning at the time set on the alarm clock.

One word of warning! Once switched on by the clock the set would remain on for at least 20 minutes, until the slow movement of the catch-wheel opened the contacts again. The break is not a quick, positive action, however, so that for about 10 seconds before it goes off the set may be affected by two or three preliminary sparks, revealed as crackles from the loud-speaker. To avoid this a suppressor could be fitted, but it should be possible simply to remember to cut out the clock by changing over the two-way switch before the 20 minutes are up.

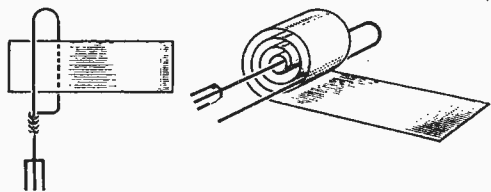

Fig. 4.—Details of the main contact.

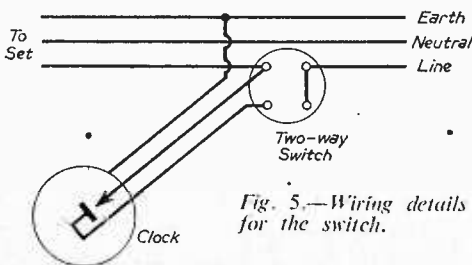

Fig. 5.—Wiring details for the switch.

**REFRESHER COURSE IN MATHEMATICS**  
 5th EDITION  
 8/6, by post 8/10. by F. J. CAMM  
 GEORGE NEWNES, LTD.  
 Tower House, Southampton Street, London, W.C.2

# Replacing Test Meter Movements

## MODIFYING A MULTI-RANGE TESTER

By F. W. Austin

**T**HIS article is concerned with the problem of renewing the meter movement in a multi-range tester when a direct replacement is not available. This could easily be the case when a test-meter has been superseded by later models and so become obsolete in the eyes of the manufacturers.

Although a 1,000 ohms per volt instrument is satisfactory for most radio servicing purposes the growing demand for higher sensitivity compels the makers to meet the demand. Consequently direct replacements for earlier models are not always obtainable and the constructor must look elsewhere for a solution.

These meters are usually fitted with a multiple scale calibration covering ohms, volts, milliamps and amperes. If the movement is 1 mA (f.s.d.) and the

The formula for the various shunts on current ranges is simply this:

$$\frac{\text{Resistance of movement}}{\text{No. of times f.s.d. for required range}-1}$$

In our 1 mA movement this becomes (for 10 mA range):

$$\frac{100 \text{ ohms}}{10-1} = \frac{100}{9} = 11.1 \text{ ohms}$$

If we substitute a 1 mA movement having a resistance of 75 ohms our shunt for the same range becomes:

$$\frac{75 \text{ ohms}}{10-1} = \frac{75}{9} = 8.33 \text{ ohms}$$

It will be clear from the above that the 75 ohms movement will give a different percentage deflection from the original unless the basic resistance is increased to 100 ohms. This is accomplished by simply placing a 25 ohms resistor in series with the movement to make up the difference. The arrangement is shown clearly in the first illustration.

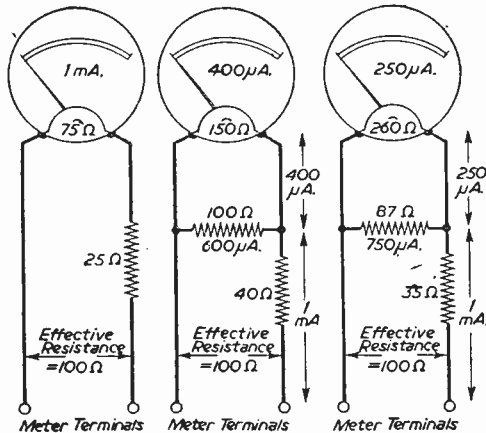

The various modifications referred to.

### Shunt and Series Arrangements

Should the constructor be fortunate enough to obtain a 500 microamp movement with a resistance of 200 ohms a parallel shunt of 200 ohms only is required for direct replacement. Other arrangements are also shown in which both series and parallel shunts are incorporated.

The first need in all cases is for the movement to be fitted with a parallel shunt which will bring the f.s.d. to 1 mA exactly. This can be found by using the formula already given; the series shunt merely brings up the combined total of shunts to 100 ohms for matching purposes.

For clarity the illustrations show the various proportions of current flowing through the movements and combined shunts. When the testmeter is switched to voltage operation the effect of the series shunts is negligible and can be disregarded.

Where a movement of similar physical size but having a larger arc of needle traverse is employed the parallel shunt must be found by practical methods as the f.s.d. of the final product will be smaller.

On no account should a movement with smaller arc be used as the extra travel of the needle may not be linear and would therefore introduce errors.

meter 1,000 ohms per volt it is not sufficient simply to transfer the calibrated scale from the original to the substitute movement: we have to take into account the fact that the scale must hold good on all ranges. This can be achieved only by matching the substitute movement with either shunt or series resistors or a combination of the two so as to present to the body of the meter a load resistance equal to the resistance of the original movement. When this has been properly done it should be possible for the substitute to agree with the original at every point of the scale on all ranges.

### Meter Movement Resistance

For the purpose of consistency the treatment of this subject is being based upon a 1 mA movement having a resistance of 100 ohms. For individual cases the reader must naturally substitute for this figure the actual resistance of his own movement.

## NEWNES RADIO ENGINEER'S VEST POCKET BOOK

By F. J. CAMM

6/-, or by post 6/4

Obtainable from booksellers, or by post from George Newnes, Ltd. (Book Dept.), Tower House, Southampton Street, Strand, W.C.2.

# Servicing Radio Receivers

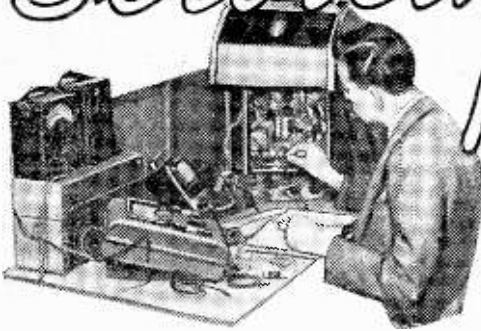

PHILCO MODEL A3606

By Gordon J. King, A.M.I.P.R.E.

**T**HIS is a two waveband A.C./D.C. receiver of transportable style. It features an internal frame aerial and five valves, including the rectifier. It is of fairly recent design and the valves employed, apart from the 35L6GT output valve, are of the B7G all-glass variety. The wavechange switch is accessible from the rear of the cabinet, and the two controls at the front of the cabinet are tuning and volume/on-off. The optimum A.F. output is in the region of 2 watts into a 5-ohm speech coil.

## The Frequency Changer

The complete circuit of the receiver is shown at Fig. 1. As will be seen, the signals induced into the loop or frame aerial L1 are tuned by C1 section of the tuning gang and applied, via switches S1A and S1B, to the signal grid of the frequency-changer valve V1. Coil L2 serves to load the aerial circuit on L.W.; C6 is a coupling capacitor, while the associated 47-ohm resistor is a grid-stopper whose purpose is to prevent positive feedback over the first stage. Trimmer T1 is for obtaining maximum sensitivity at the high-frequency end of the M.W. band.

A facility is available, via capacitor C7 and a tapping on the frame aerial, to apply signals from an external aerial.

The mixer section of the frequency-changer valve is biased from the A.V.C. line, the connection being made through R1, while C8 is the A.V.C. line decoupling capacitor.

A cathode-coupled oscillator is used in conjunction with the L.W. oscillator coil L3 and the M.W. oscillator coil L4. The oscillator circuit is tuned by C2 section of the tuning gang. T2 is the L.W. oscillator trimmer, T4 the L.W. padder, T5 the M.W. oscillator trimmer and T3 the M.W. padder. A degree of fixed bias is given to the frequency-changer valve by reason of the cathode resistor R2. Capacitor C8 and resistor R3 constitute the oscillator coupling components. The oscillator coils are selected by the simple two-way switch S1C which, of course, is integral to the complete wave-change switch wafer.

The I.F. transformers are adjusted to accept a frequency of 470 kc/s, the first of these transformers being in the anode circuit of the frequency-changer valve.

Lack of signals on any one waveband is often caused by a short-circuit (normally of an intermittent

nature) developing in one of the oscillator trimmers. This can generally be corrected quite easily by removing the trimmer adjusting screw and resetting the top plate of the trimmer so that when it is under pressure the corners of the top plate are adequately insulated by the mica.

Lack of signals on both bands, while examination reveals that life exists right up to the anode of the frequency-changer valve, is often caused by failure of the oscillator coupling capacitor C8—if in any doubt about this component always replace it. Excessive crackling on one or both wavebands has been proved to be caused by a fault in one of the oscillator coils. Usually, when this fault exists the coils check from the continuity aspect, and no alteration in resistance can be noted, though replacing the coils always cures the trouble. It should be mentioned that crackling due to this cause is present even with pin No. 7 on the frequency-changer valve shorted to chassis.

## The I.F. Amplifier

The 470 kc/s signal developed in the first I.F. transformer (I.F.T.1) is conveyed to the signal grid (pin No. 1) of the 6BJ6 I.F. amplifier valve V2; the amplified I.F. signal is thus developed in the second I.F. transformer (I.F.T.2). It is interesting to observe that both the control grid and the suppressor grid of V2 are in receipt of an A.V.C. bias, via the secondary winding of I.F.T.1. A degree of fixed bias and negative feedback is given by the 47-ohm unby-passed cathode resistor.

Lack of sensitivity accompanied by impaired selectivity is sometimes caused by a reduction in insulation resistance of one or more of the 75 pF fixed I.F. tuning capacitors. Similarly, an alteration in value of one or more of these capacitors should be

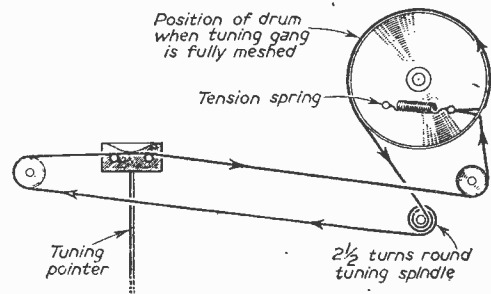

Fig. 4.—Dial cord details. Thirty inches of nylon drive cord are needed.

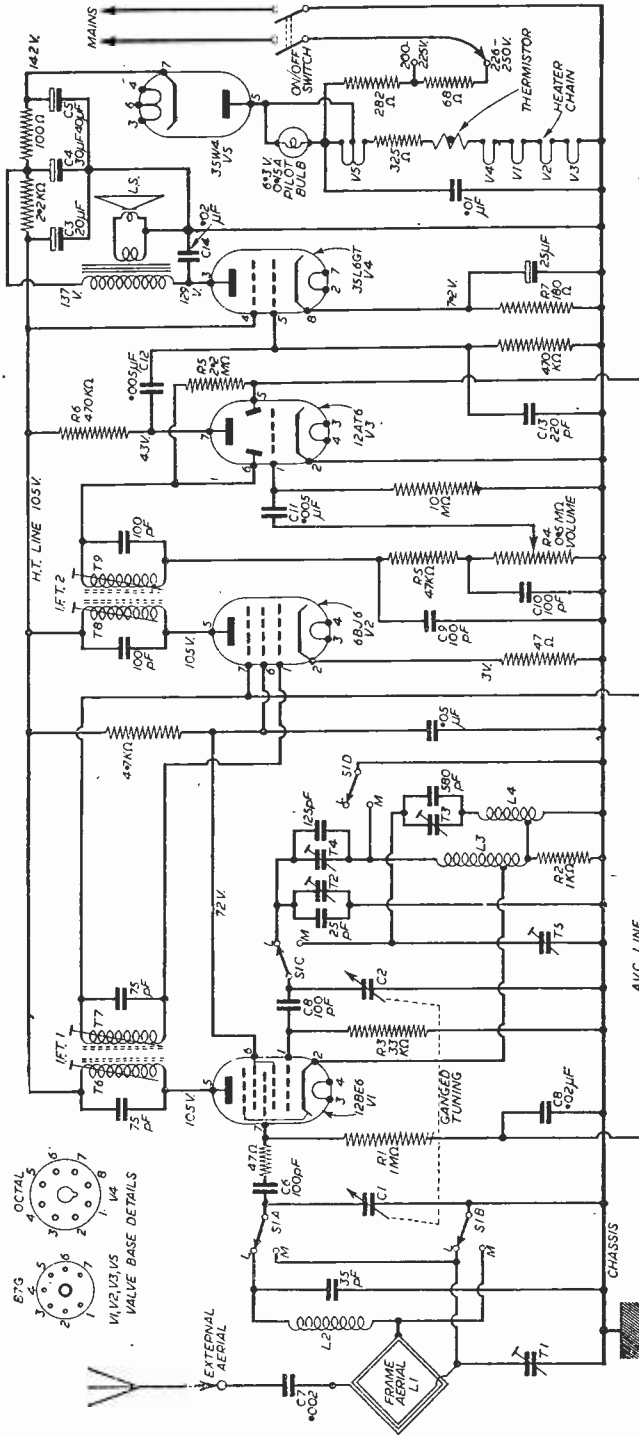

Fig. 1.—Theoretical circuit of the Philco A3606.

suspected. In this latter connection, however, the sensitivity may temporarily be restored by readjusting the I.F. trimmers. This practice is not recommended, as a further drift in capacitance would cause the same trouble. It is much better to be on the safe side and replace a suspect, even though it means dismantling the I.F. transformer.

**The Detector, A.V.C. and A.F. Amplifier**

The secondary of the second i.F. transformer are coupled direct to the signal diode of the 12AT6 V3. The A.F. content of the signal is developed mainly across the volume control R4 which works as the detector load. The network comprising R5, C9 and C10 serves to rid the A.F. signal at this point of any unwanted I.F. signal; it is purely a filter, therefore. A portion of the I.F. signal in the second I.F. transformer is conveyed to the A.V.C. diode through R5. It is here rectified, decoupled by C8 and used as an A.V.C. bias.

The required level of A.F. is tapped off at the volume control and passed through C11 for application to the grid of V3. This triode section amplifies the A.F. and develops it in magnified form across the anode load resistor R6.

Sound distortion at this section often crops up due to an increase in value of R6. It has been known for this resistor to rise above 1 megohm. The set still functions, though the quality of reproduction is most disturbing at high volume levels.

Noisy operation of the volume control may demand complete replacement, though on the other hand, it may easily be cleared by instilling a few drops of "switch cleaner" between the spindle and bush.

**The Output Stage**

The signal across R6 is transmitted to the control grid of the 35L6GT output valve through the coupling capacitor C12. The output valve is biased by R7, while the associated 25 μF capacitor precludes the possibility of negative current feedback. A degree of fixed tone control is given by C13 and C14.

Another source of severe distortion lies in C12. If this develops even the smallest of leaks, a positive voltage will find its way to the output valve control grid. This will have the effect of outweighing the cathode-produced negative bias

and cause the valve to operate well off the straight part of its curve. This fault, apart from the distortion factor, will be revealed by the cathode voltage rising above the stipulated 7.2 volts; the valve will also overheat and the H.T. line voltage may fall below 105 volts. We would add that a leak in R12 soon kills the 35L6GT.

**The Power Section**

As this is a receiver which can be used on either A.C. or D.C. mains, the valve heaters are series connected across the mains supply. The total heater current is 0.15 amp., and the current is limited to this value by a 325 ohms resistor and a voltage selecting tapped resistor.

A thermistor (Brimistor type CZ2) is also included in the heater chain. The purpose of this is to eliminate the sudden surge of current through the heaters when the set is first switched on. This would be liable to occur, because when the heaters of the valves are cold their resistance is much lower than it is at working temperature. A thermistor ensures a very gentle heating-up process, for when cold, its resistance is very high, and when the set is first switched on from cold almost all the applied voltage is dropped across the thermistor.

Power for the pilot bulb is picked up from the heater tap on the 35W4 H.T. rectifier valve V5. The A.C. voltage existing at the same point, relative to chassis, is applied to the anode of the H.T. rectifier valve. Full H.T. voltage is developed across the reservoir capacitor C5, and smoothing is carried out by C4 and C3.

Excessive mains hum and/or low H.T. voltage should lead one to suspect a reduction in value of one of the electrolytics.

**Circuit Alignment**

Connect a suitable output meter across the loudspeaker terminals, set volume control to maximum and ensure that the tuning pointer coincides with the first left-hand dot on the scale when the plates of the tuning gang are fully meshed—correct if necessary.

(1) Disconnect the frame aerial from the chassis and remove chassis from the cabinet.

(2) Tune the generator to 470 kc/s and connect, via 0.1  $\mu$ F isolating capacitors, between C1 of the tuning gang and chassis (use a modulated signal for all adjustments) and adjust T9 (Fig. 3), T8 (Fig. 2), T7 (Fig. 2) and T6 (Fig. 3) in that order, for maximum indication on the output meter, and repeat until no further improvement can be obtained. (3) Re-assemble chassis in cabinet and reconnect the frame aerial.

(4) With the generator tuned to 1,500 kc/s, inject signal between the chassis, via an 0.1  $\mu$ F capacitor,

and the blue aerial lead, via a 2.2 K. resistor and an 0.1  $\mu$ F capacitor. Tune the receiver to 200 m. (M.W.) and adjust T5 (Fig. 2) and T1 (Fig. 2) for maximum indication on the output meter.

(5) With the generator connected as above, tune to 580 kc/s; tune receiver to the 580 kc/s point marked on the scale (M.W.) and adjust T3 (Fig. 3) for maximum indication on the output meter whilst rocking the tuning gang.

(6) Repeat (4) above.

(7) With the generator connected as above, tune to 350 kc/s; tune receiver to the 350 kc/s point marked on the scale (L.W.) and adjust T2 for maximum indication on the output meter whilst rocking tuning gang.

(8) With the generator connected as above, tune to 160 kc/s; tune receiver to the 160 kc/s point marked on the scale (L.W.) and adjust T4 (Fig. 3) for maximum indication on the output meter whilst rocking tuning gang.

(9) Finally, repeat operations (7) and (8) above. The signal generator signal output should be reduced as the circuits approach correct alignment, and the A.F. output should not exceed 0.5 volt.

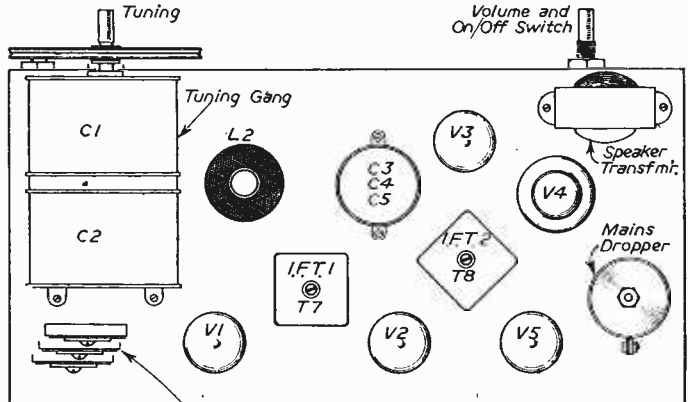

Bank of 3 trimmers From top:—T1, T5, T2

Fig. 2

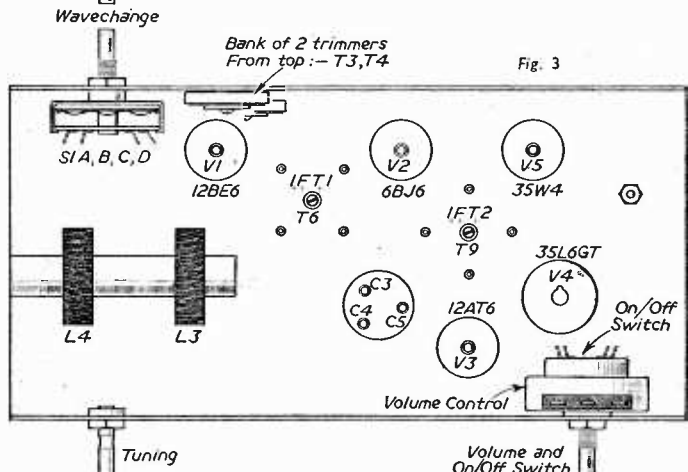

Bank of 2 trimmers From top:—T3, T4

Fig. 3

Figs. 2 & 3.—Top and underside of chassis details.

# Simple Adjustable Voltage Supplies

HINTS FOR THE EXPERIMENTER

By C. H. Banthorpe

WHEN experimental work is being carried out it is often necessary to have a source of variable voltage, either positive or negative or both and in some cases a variable or pre-set voltage has to be included in equipment. For such purposes the author has found the following circuits cheap and useful.

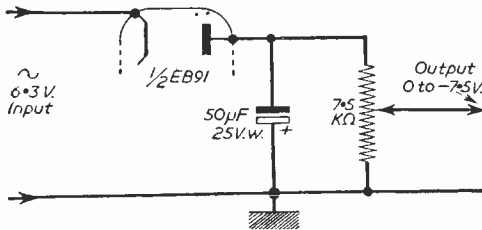

Fig. 1.—A simple source of grid bias.

The first, Fig. 1, is the cheapest of all and has been used as a source of grid bias. It uses the heater voltage as an A.C. supply and gives an output sufficient for most receiving type valves. If several different voltages are required then a tapped resistor network may be used or several potentiometers may be connected across the output.

## Voltage Doubler

When the voltage is insufficient a voltage doubler circuit may be used as shown in Fig. 2. In both these circuits the polarity of the output may be reversed by reversing all valves and, of course, the electrolytics. The output voltages shown in Figs. 1 and 2 will be supplied under the condition given, i.e., 1 mA output current, but higher currents can be taken with an appropriate loss of output voltage. The makers of the EB91 give 9 mA as a limiting current, but, of course, almost any double diode, separate diodes or metal rectifiers may be used provided the makers' ratings are observed.

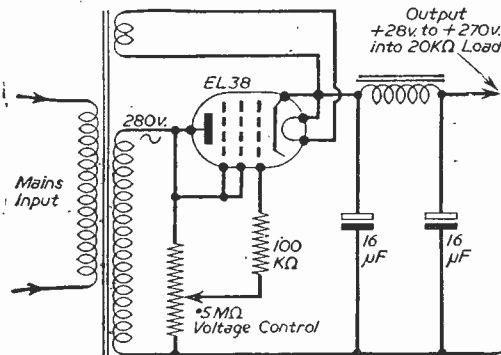

Fig. 3.—This circuit will provide higher voltages and currents.

## Higher Voltages

For higher voltages and currents the circuits of Figs. 3 and 4 are useful. Fig. 3 has been used for supplying a variable G2 voltage for gain control of a television receiver and for work on oscillators. In the circuit of

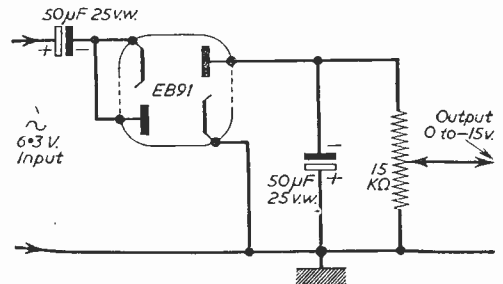

Fig. 2.—This arrangement gives increased voltage.

Fig. 3 fairly high peak voltages +ve and -ve are applied to the anode of the valve and to the potentiometer used for the output voltage control. A top anode valve such as the one shown is, therefore, desirable and a number of suitable alternative ones exist. The potentiometer should be one of good quality or breakdown of the track or between the track and bush may occur.

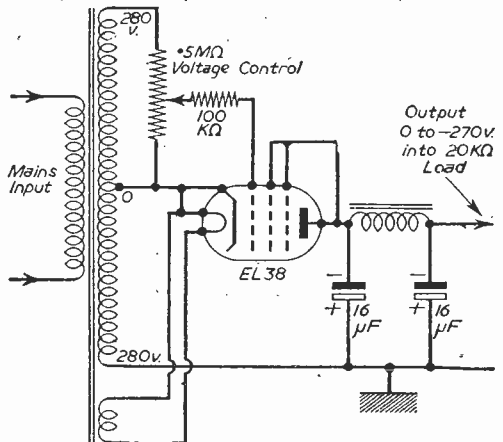

Fig. 4.—Another high power arrangement.

## THE SUPERHET MANUAL

5th Impression

By F. J. CAMM

7/6, by post 7/10

From

GEORGE NEWNES, LTD.,

Tower House, Southampton Street, Strand, W.C.2.

# A Simple F.M. Tuner Unit

DETAILS OF A SIMPLIFIED MAINS-OPERATED ADD-ON UNIT

By J. Kells, M.Inst.E., M.I.P.R.E.

HERE is a simplified tuner which has given excellent results on test in Yorkshire. Although originally built to receive Pontop Pike transmissions it was found that the Wrotham station in Kent could also be heard with consistent reliability.

Although the power supply is shown in the circuit diagram (Fig. 1) it is quite in order to take power from any audio equipment which is to be used with the tuner—provided that one has already first satisfied oneself that the power section of such apparatus is adequately rated and, therefore, fully capable of standing up to the increased load. Power requirements are: L.T. 6.3 volts, 0.8 amp.; H.T. 180 volts, 25 mA.

Since both simplicity and cost have been carefully considered, the main items of expense will be the valves (unless, of course, the constructor is fortunate enough to have the appropriate types or their equivalents available), since all transformers and coils may be wound very easily and cheaply.

Alignment is simple. No special signal generator or oscilloscope is required.

## The Circuit

The double triode (V2) is a push-pull oscillator running at 7.5 Mc/s below the F.M. rest frequency. This oscillator is inductively coupled to the frequency changer pentode (V1), to which the incoming signal is fed direct from the aerial. Taps, or a crocodile clip, will provide for optimum coupling in this position. The reason for choosing the push-pull type of oscillator was because it runs satisfactorily with a relatively low input power, and also frequency

stability is good. This means that drift during the warming up period is minimised. On the prototype it appears to have been completely eliminated. The separate oscillator and its coupling arrangements to the frequency changer have also been designed to minimise "pulling".

In order to lower the "Q" of the anode load inductance sufficiently to handle adequately the broad bandwidth associated with F.M., the coil is in this case wound directly upon a 68 K., 2 watt resistor, which provides just the right damping effect across the parallel tuned circuit.

Cost of construction is further reduced by dispensing with the need for an I.F. transformer between the frequency changer and I.F. amplifier stages. Capacitive coupling was used instead, and there seems to be no disadvantage in having used this method. Should the constructor decide to add a further stage of I.F. amplification, this could well be effected merely by duplication of the existing stage. The remainder of the circuit so far should require no further explanation.

The discriminator transformer was made from a dismantled 465 kc/s I.F. can (without dust cores) which had been unearthed from the junk box. Strip off all old windings, and replace with two new windings, as shown clearly in Fig. 2. Should there have been iron dust cores in the old former they must, of course, be removed or the final inductance values will be inaccurate.

## The Detector

The type of detector used in this circuit is known as

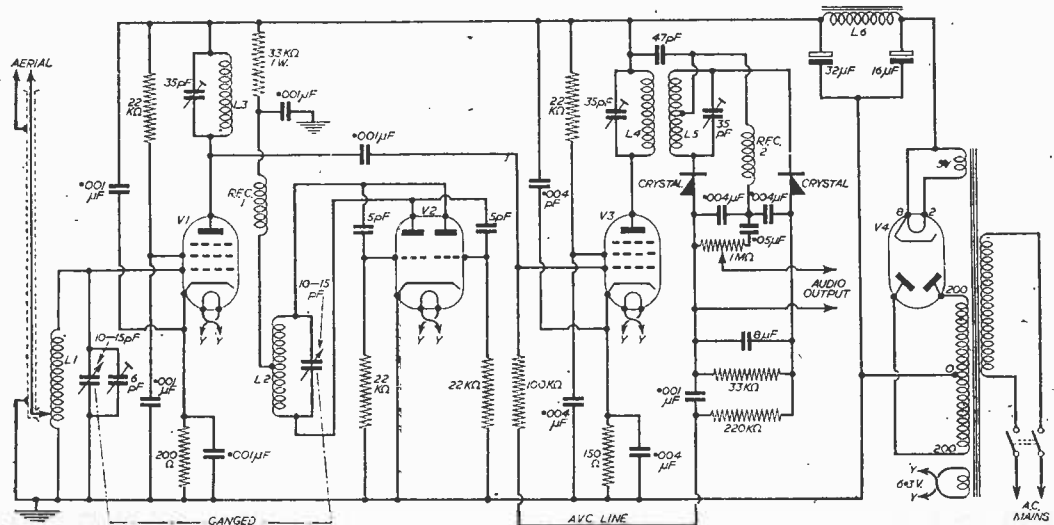

Fig. 1.—Circuit of the F.M. Tuner.

a ratio discriminator, and was chosen because it requires very much less gain in the preceding stages than most other types of F.M. detector. In general, most types of discriminator necessitate the use of an additional stage known as a limiter, which produces a peak-clipping action and so eliminates most interference (which is mainly A.M., and tends to travel on wave peaks). The ratio discriminator has a self-limiting action, and hence one more stage is saved.

The diodes shown in the circuit diagram may be either valves or crystals. Either will give satisfactory results, but, of course, crystals are cheaper, lighter, and require no special power supplies to operate them. A 6H6 would be an ideal type of valve to use here (equivalents are D63 and EB34).

The main tuning condenser is a made-up ganged unit consisting of two small 10 or 15  $\mu\mu\text{F}$  tuning condensers (about two stators and one rotor each). These may be mounted back to back and the rear ends of their spindles coupled by means of a length of Perspex or ebonite rod. The coupling should be rigid. Before mounting this assembly on the chassis

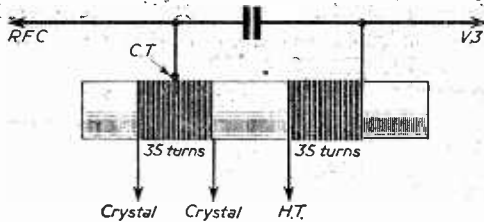

Fig. 2.—Details of the discriminator transformer.

it must be fixed to a low-loss insulated baseplate. This is important, because both sets of plates in the oscillator section of the gang are "live" to R.F. and to D.C.

When laying out the chassis the main point to bear in mind is that the oscillator and mixer valve bases should be so arranged as to result in the shortest possible wiring between themselves and the tuning condensers and coils. All precautions should be taken in order to minimise stray capacities, which become so troublesome at these frequencies. Keep I.F. grid and anode leads as short as possible, too, in order to avoid spurious oscillations in that stage.

The audio output is taken via 1 megohm volume control to sockets or a suitable jack at the rear of the chassis.

Voltage readings on the prototype are:

	Anode	Screen
Frequency changer	180	120
I.F. amplifier	180	120
Oscillator	30	—

**Alignment**

Inject a 7.5 Mc/s signal into the grid of the frequency changer and connect a high-resistance voltmeter between the A.V.C. line and chassis.

Remove the oscillator valve (V2). Now adjust the I.F. trimmers for maximum A.V.C. voltage (this should be roughly 3 volts). If it appears that peaking is impossible at 7.5 Mc/s; then alter the input frequency, from the signal generator slightly in each direction until it appears obvious that maximum A.V.C. voltage can be obtained with the trimmers about their middle setting. The exact I.F. is not critical.

Now replace the oscillator valve. If this stage is oscillating, a high-resistance voltmeter connected between either of the grids of V2 and chassis should show a rectified grid voltage of approximately 0.5 volts.

Assuming all is now working correctly, connect the aerial and adjust the tapping only one turn up from the bottom of the coil in the first instance. Tune in an external signal and adjust this tapping for maximum A.V.C. voltage with the meter in its original position.

With the prototype tuner it was found that when

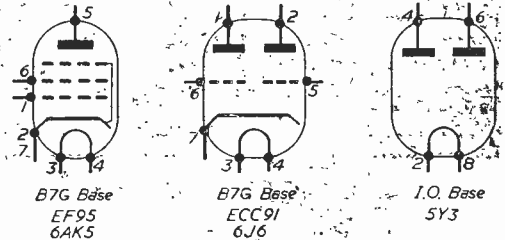

Fig. 3.—Valve base details.

receiving Pontop Pike at a site some 12 miles from Darlington the limiting action of the discriminator was sufficient completely to overcome car ignition and similar interference, but when Wrotham was being received amplitude pulses were sometimes audible. This supports the theory that with this type of discriminator limiting effectiveness decreases with falling signal strength.

No practical layout has been given as it is assumed that the constructor will use his own ideas, adhering to the theoretical circuit. For instance, he may wish to use space on an existing receiver, or to build the unit as a completely self-contained add-on addition to an existing receiver.

**JOIN THE PRACTICAL GROUP**

Edited by F. J. CAMM

- PRACTICAL TELEVISION ... .. 1/3  
Every Month.
- PRACTICAL MECHANICS ... .. 1/3  
Every Month.  
Devoted to Mechanics, Science and Invention.
- PRACTICAL MOTORIST & MOTOR CYCLIST ... .. 1/3  
Every Month.
- PRACTICAL HOUSEHOLDER ... .. 1/3  
Every Month.



# NEW! THE PRACTICAL WAY

of learning **RADIO • TELEVISION • ELECTRONICS**  
**AMATEUR S.W. RADIO • MECHANICS • PHOTOGRAPHY • CARPENTRY • ETC.**



**DO IT YOURSELF!**  
**IN YOUR OWN HOME — IN YOUR OWN TIME**

An entirely new series of courses designed to teach Radio, Television and Electronics more quickly and thoroughly than any other method. Specially prepared sets of radio parts are supplied and with these we teach you, in your own home, the working of fundamental electronic circuits and bring you easily to the point when you can construct and service radio receivers, etc.

Whether you are a student for an examination; starting a new hobby; intent upon a career in industry; or running your own business; — these Practical Courses are ideal and may be yours at very moderate cost.

With these outfits, which you receive upon enrolment and which remain your property, you are instructed how to build basic Electronic Circuits (Amplifiers, Oscillators, Power Units, etc.) leading to designing, testing and servicing of complete Radio and Television Receivers.

Photograph of E.M.I. factories at Hayes—our industria background.

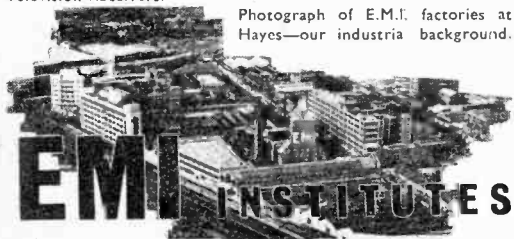

An Educational Organisation associated with the E.M.I. group of Companies including: 'HIS MASTER'S VOICE', COLUMBIA, etc.

**OTHER COURSES WITH PRACTICAL EQUIPMENT INCLUDE: RADIO (Elementary and Advanced) • TELEVISION ON MECHANICS • ELECTRICITY • CHEMISTRY • PHOTOGRAPHY • CARPENTRY.**

Also Draftsmanship • Commercial Art • Amateur S.W. Radio • Languages • Simple Electrical Repairs in the Home • Painting and Decorating • Etc. • Etc.

With these outfits, you are given instructions that teach you the basic principles in the subject concerned.

**NEW TELEVISION COURSE**

including a complete set of equipment dealing with the design, construction and servicing of a high quality television receiver.

**COURSES**

(with equipment) also available in many other Engineering subjects.

**COURSES FROM 15/- PER MONTH**

To E.M.I. INSTITUTES,  
 Dept. 32, 43 Grove Park Road,  
 London, W.4.



NAME \_\_\_\_\_  
 ADDRESS \_\_\_\_\_  
 SUBJECT(S) OF INTEREST \_\_\_\_\_  
ALWAYS (We shall not worry you with personal visits)

K761

# PREMIER RADIO COMPANY

B. H. MORRIS & CO., (RADIO) LTD.

OPEN TILL 6 P.M. SATURDAYS (Dept. P.W.) 207, EDGWARE ROAD, LONDON, W.2

Telephone: 4033  
AMBASSADOR  
PADDDINGTON 3271-2

## BUILD THESE NEW PREMIER DESIGNS

### 3-BAND SUPERHET RECEIVER

MAY BE BUILT FOR **£7.19.6** Plus 3/- Pk. & Carr.

Latest type Superhet Circuit using 4 valves and metal rectifiers for operation on 200/250 volts A.C. mains. Waveband coverage—short 16-50 metres, medium 180-550 metres, and long 900-2,000 metres. Valve line-up 6K3 freq. changer, 6K7, 1F, 6Q7, Detector AVC and first AF, 6V6 output. The attractive cabinet to house the Receiver size 12in. long, 6 1/2in. high, 5 1/2in. deep can be supplied in either WALNUT or IVORY BAKELITE or WOOD. INSTRUCTION BOOKS 1/- each (post free) which includes Assembly and wiring diagrams, also a detailed Stock List of priced components.

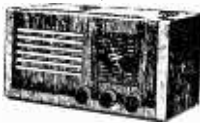

### TRF RECEIVER

MAY BE BUILT FOR **£5.15.0** Plus 3/- Pkg. & Carr.

The circuit is the latest type TRF using 3 valves and Metal Rectifiers for operation on 200/250 A.C. mains. Wave band coverage is 180/550 metres on medium wave and 100/2,000 metres on long wave. The dial is illuminated and the Valve line-up is 6K7 H.F. Pentode 6J7 Detector and 6V6—Output.

illuminated and the Valve line-up is 6K7 H.F. Pentode 6J7 Detector and 6V6—Output.

### 4-WATT AMPLIFIER

MAY BE BUILT FOR **£4.10.0** Plus 2/6 Pk. & Carr.

Valve line-up 6SL7, 6V6 and 6X5. FOR A.C. MAINS 200/250 VOLTS. Suitable for either 3-ohm or 15-ohm Speakers. Negative feedback. Any type of pick-up may be used. Overall size 9 x 7 x 5 1/2in. Price of Amplifier complete, tested and ready for use, £5.5.0 plus 3/6 pkg. and carr.



### GABINETS—PORTABLE

Model PC/1 Brown Rexine covered, 15 1/2in. x 13 1/2in. x 5 1/2in. Clearance under lid when closed 2 1/2in.  
Model PC/2 Grey Lizard Rexine covered, 45/- Overall dimensions 15in. x 13in. x 6in. Clearance under lid when closed 3in.  
Model PC/3 Rexine type covering in various colours, 69/8.

Overall dimensions 16 1/2in. x 14 1/2in. x 10 1/2in. Clearance under lid when closed 6 1/2in. All the above Cabinets are supplied with Panel Carrying Handle and Clips. Packing and Postage 2/6.

Send for details of the Premier Wide angle Telescop design which may be built for £30.

### ALL-DRY BATTERY PORTABLE RADIO RECEIVER

4 miniature Valves in a Superhet Circuit covering medium and long waves. Rexine covered Cabinets 11 1/2in. x 10 1/2in. x 5 1/2in. in two contrasting colours. Wine with Grey Panel, please state choice when ordering. THE SET MAY BE USED EVERYWHERE—home, office, car or holidays. INSTRUCTION BOOK 1/6 (Post Free) which includes Assembly and wiring diagrams, also a detailed Stock List of priced components.

A Range of High Fidelity Amplifiers, Speakers and Record Players by the following makers in stock: Leak, E.A.R., Rogers, Goodmans, Wharfedale, W.B. Stentorian, Larenz, B.S.R., Collard, Garrard, Lenco, Commoisseur. We shall be only too pleased to demonstrate any of the above equipment.

MAY BE BUILT FOR **£7.8.0**

Plus 2/6 Pk. & Carr.

diagrams, also a



B.S.R. Monarch 3 speed Autochanger £7.19.6, postage and packing 5/-

3 Speed single player with crystal tune wheel £8.19.6, postage and packing 5/-

## OSMOR "Q" COIL PACK ASSEMBLY

Size only 1 1/2in. x 3 1/2in. x 2 1/2in.

Simply press home 4 OSMOR High "Q" coils—make only 8 easy connections and hey presto!—you have a complete OSMOR High "Q" Coilpack at a much reduced price. M. & L. wavebands, perfect for constructing new sets or conversions. Full circuit and wiring instructions included.

Gram' position. Price **16/-** (less coils).

Punched Chassis with wiring diagrams ready for Seven/5'shet 12/6 plus 2/- p. & p.

### BAND 1 FILTER

Rejects B.B.C. from I.T.A. aerial and improves picture. Suitable for all makes.

10/- inc. instructions. Fitted in 2 minutes.

### Osmor NEW Station Separator

This improved type incorporates a special coil which has a peak performance on the station for which it is designed. As the inductance at maximum "Q" is only variable by a small degree, please state precisely the Station you wish to receive clearly. It will only operate on one Station.

FERRITE ROD AERIALS  
HIGH "Q" M.W., 8/9,  
M. & L.W., 12/9.

**10'6**  
Price

### The Osmor NEW DIAL Assembly

This is a really attractive horizontal 3-colour slide rule, precision-built assembly. Complete with 6-Band Perspex scale 9in. x 4 1/2in., for chassis-mounting L., M. and S. wavebands with Station names. The vernier drive has a ratio of 18-1 search, and 50-1 reverse. Positions for two dial bulbs. Calibrated specially for Osmor Coils and Coil-packs, Scale Length 7in. Type 5.

**24'6**  
Price

Escutcheon for above, Bronze Finish Metal 4/-

We keep right up to date in building the latest circuits, published in "Practical Wireless" — "Wireless World," and "Radio Constructor," and we stock the components specified. Send 7 1/2d. in stamps for circuits, wiring diagrams, fully descriptive literature together with coil and coilpack leaflets, components, lists, chassis drawings and templates.

**OSMOR RADIO PRODUCTS LTD.**

418 Brighton Road, South Croydon,  
Surrey. Telephone Croydon 5148/9.

Still only 5 connections  
Smaller in size  
many plus' features  
The New  
AMAZINGLY ROBUST  
O pack  
FROM  
42/-  
FREE  
CIRCUITS & WIRING DIAGRAMS

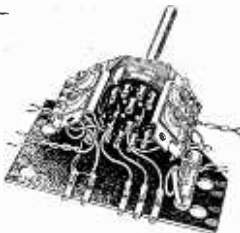
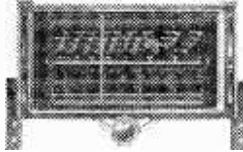



# On Your Wavelength

BY THERMION

## Those Organ Grinders!

**C**AN something be done by the BBC to improve the standard of the programmes of organ music which they radiate? Many of these are recitals on cinema organs of the electronic type, and most of the organists seem to be under the impression that it is not a musical instrument, but a device on which they can exhibit their digital dexterity on the keyboard, using every stop that they can lay their hands on. In general I do not like organ music. It is not sweet music, and there is a hurdy-gurdy sound about it. It sounds *miserable*, but at the same time if the piece which is being played is discernible there is a compensation. I claim to have a fair knowledge of music and certainly have an ear for it. My mental repertoire of melodies is as good as anyone's, and if the air is properly played I can recognise it immediately. Indeed, when I hear a new tune I can score it in the tonic solfa notation as fast as it is being played, later translating it to the old notation which cannot, as with the tonic system, be taken down like shorthand.

These thoughts are encouraged by listening to a programme of music played by Sandy Macpherson recently, and he had been playing for at least a minute before I recognised very faintly the air of a well-known melody, played against a background of heavy bass with the addition of frills and appoggiaturas and glissandos. It was anything but melodious. Please, Sandy, can you concentrate on your right hand and play the left hand down a bit so that we can hear the air? We all know you can play the organ and that you know where the stops are. I could wish that you could forget a few of them. Let us hear the air and less of the bass.

Remember you are playing *music*, and forget you are playing an *instrument!*

## Old Receivers

**I**HAVE received a very large number of letters from readers possessing vintage receivers, both commercial and home-built. Well do I remember the circuit published by the Mullard Valve Company, about 1928, for which they supplied a kit. Mr. K. M. Cox, of Stockport, tells me that this set has been in daily use ever since he built it. The circuit was an S.G., leaky grid detector and L.F. amplifier, H.T. being drawn from eliminator with a trickle charger for the two-volt accumulator, feeding the two-volt, three-electrode valves. Renewals, of course, must now be obtained from the surplus stores, but as you will see from our advertisers they are still available. The volume and quality are quite good, the L.F. stage comprising a Lissen iron-cored transformer of low ratio, feeding a super-power 230 output valve with a choke and condenser output filter. There are separate tuning condensers for H.F. and detector stages. Then there was the Melody Maker Kit put out by Cossors and the Music Magnet Kit, marketed by G.E.C. I still possess one of the latter, and it is functioning as well as the day it was built. Of

course, it is not so selective as modern receivers, but sufficiently so to receive without overlap or breakthrough the BBC transmissions.

At the time of writing, no arrangements have been made for exhibiting these old receivers, the loan of which has been promised by so many readers. I am continuing my efforts.

Another reader, Mr. L. J. A. Cox, of Hanworth, writes, "Re ancient receivers, there is one such hanging on the wall of my workshop down in Wiltshire, which was given me by the radio dealer who used to handle business for Sir Oliver Lodge. It is a set which he had made to his instructions by A. J. S., and, according to the donor, contains the prototypes of the square law condensers we used to use. As far as I remember there are four valves, each with its own filament rheo. and positions for using two, three or four valves.

"It is mounted on a single ebonite panel, has swinging coil reaction, and is, I think, Det., three L.F.

"I have also three old German triodes, with a leg at each corner, the original labels still in place. I don't believe they have ever been used. These items were stowed away with the idea that perhaps some day they might earn an honest penny in a Radio Antiques Show of some sort."

The days of the detector-2 L.F. receiver and similar circuits are, unfortunately, in some ways over. Circuits have become more complicated and more valves are employed as well as many other extra components, but I doubt whether some of the modern receivers exceed the quality of some of those early models.

## Car Radio

**T**AKE, for example, some of the modern car radio receivers. I have one fitted to my own car—a push-button job, employing an eight-valve superhet circuit. The quality is atrocious and, although there is a push button for the long wave, it does not receive one long wave programme. The set is full of wow and dither, and overloads at the slightest increase in volume. I could achieve far better results with fewer valves! This particular receiver costs well over £40 and it is certainly inferior in performance to those produced in the '20s. Incidentally, I have found that the vibrating reed converter is a common and frequent source of trouble, and those of my friends who have car radios confirm my experiences.

## The Radio Show

**A**S I write, manufacturers are busy with their 1957 programmes—all very hush-hush, and nothing much is known at present. I do hope, however, that this year some of the criticisms I made concerning the Exhibition and the Exhibition Building last year will be unnecessary this. There should be clearer marking of the Stand Numbers, and they should be located in a standard position where all can see. One can become hopelessly "lost" at Earls Court.

# TRANSMITTING TOPICS

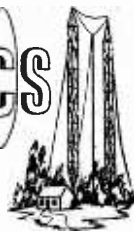

## SOME VERSATILE GROUND PLANES

By O. J. Russell, B.Sc., A.Inst.P. (G3BHJ)

**T**HE ground plane has a select circle of followers. These comprise many hard-bitten DX men of renown, for the ground plane with its low angle of radiation (and of reception) is not only first class as a radiator for working extreme DX, but also on reception it actually gives a good measure of discrimination against short skip European QRM, while boosting reception of extreme distance low angle signals. For this reason it is justly esteemed among many DX men who are interested in long haul QSOs and who are allergic to Continental QRM.

There is another reason also why the ground plane finds favour. It is an extremely compact aerial for the higher frequencies, which makes it popular with those in restricted locations. Sufferers from restricted sites included many city dwellers and those pent up in council estates, flats and prefabs. The fact that the vertical radiator may be an unsupported rod or tube is also valuable from the constructional angle. Moreover, a 10-metre ground plane may be erected in all but the smallest backyard, while up to 20-metre ground planes can be erected in very small gardens.

However, there is one feature, or supposed feature, of the ground plane. It is popularly considered as a "one band" device. Indeed, many using a ground plane aerial with success upon its fundamental or design frequency have not been able to obtain satisfactory results upon other bands. However, these difficulties may often be overcome with attention to various aspects of aerial operation, resulting in multiband operation with a single ground plane

aerial. The following observations are based upon some experiments recently concluded upon a ground plane installed in a restricted location, and they should be of interest to many other users of this deservedly popular form of aerial.

To refresh the memory, Fig. 1 repeats the design dimensions for constructing the ground plane described some little time ago, and which resulted in many letters from readers who had obtained good results with ground planes dimensioned to these values. However, a popular, in fact, almost universal, feed system for the ground plane type of aerial is by coaxial cable. As a good match may be made to 50-ohm cable, standing waves are virtually absent, and the precise length of the cable is immaterial. However, it should be noted that if multiband operation of a ground plane is attempted, then the feed point impedance changes drastically, and a high standing-wave ratio causes standing waves to appear upon the feeding cable. Moreover, the centre of the earthing radials may become a "hot" or voltage feed point, so that the outer sheath of the coaxial cable is no longer "earthy," but may actually carry standing waves externally. If, as is usual, the outer sheath is earthed at the aerial coupler, then efficient feeding may not be possible. Accordingly for multiband operation, it is advised that the feeder be replaced by 300-ohm twin-line, or by air spaced feeders. This now enables standing waves to be tolerated without excessive losses, and also enables the line to be "hot" at the aerial end without any

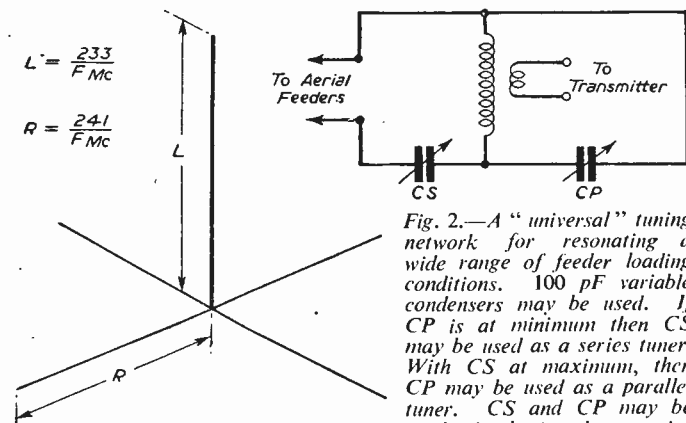

Fig. 1.—Dimensions of radiator ( $L$ ) and the radials ( $R$ ) for the ground plane aerial.  $F$  Mc/s is the operating frequency in megacycles, dimensions are in feet.

Fig. 2.—A "universal" tuning network for resonating a wide range of feeder loading conditions. 100 pF variable condensers may be used. If  $CP$  is at minimum then  $CS$  may be used as a series tuner. With  $CS$  at maximum, then  $CP$  may be used as a parallel tuner.  $CS$  and  $CP$  may be used simultaneously to give a wide range of tuning adjustments with odd feeder lengths. The tuner should be link coupled to the transmitter output.

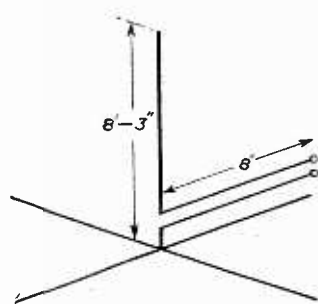

Fig. 3.—The 10-metre ground plane with 8 ft. of feeder may be resonated on 28 Mc/s, 21 Mc/s, and 14 Mc/s. Dimensions are approximate and the text explains how feeder and element lengths may be adjusted. For 28 Mc/s use parallel tuning; for 21 Mc/s series or parallel tuning; for 14 Mc/s series tuning.

unbalance worries. Naturally, the change to out-and-out resonant feeders means that the length of feeder employed must be considered, and also that the aerial tuner arrangements be rejigged to cope with the impedance values to be expected with resonant feeder operation. This leads us to the "universal" aerial coupler arrangement of Fig. 2, which can be adjusted for series, parallel or a mixture of the two without any switching arrangements. When operating "parallel," the series aerial condenser is turned to maximum and tuning is carried out on the parallel condenser. When using "series" operation the parallel condenser is turned to its minimum position, and tuning carried out on the series condenser only. However, with feeder lengths not exactly correct, it will often be found that the "series" condenser can be adjusted so as to "tune out" feeders having residual inductive reactance, so that in many cases

twin feeder, will also operate upon the 14, 21 and 28 Mc/s bands. In this case series tune for 14 Mc/s, use either series or parallel tuning on 21 Mc/s, and parallel tune for 28 Mc/s operation. We can proceed of course to Fig. 5 and use a full 14 Mc/s ground plane, and use 10 ft. of feeder. This will need series tuning on 14 Mc/s, and may need series or parallel tuning on 21 Mc/s, with parallel tuning on 28 Mc/s.

Having thus departed from the original ground plane principle, we may take a further step. This is shown in Fig. 6, where we cut the ground plane for operation upon 11.7 Mc/s. This gives an "extended radiator" for operation upon 14 Mc/s, a half wave vertical on 21 Mc/s, and an "extended half wave radiator" on 28 Mc/s. The use of this system requires a 10-ft. minimum feeder length. The tuner for this arrangement is parallel tuning for 14 Mc/s, series

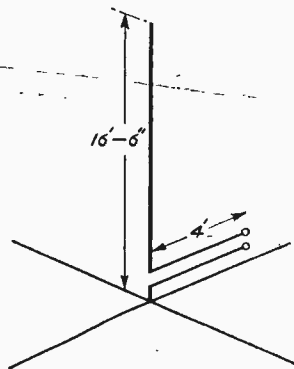

Fig. 5.—The 14 Mc/s ground plane may also be resonated on three bands. For 14 and 21 Mc/s use series tuning; for 28 Mc/s use series or parallel tuning.

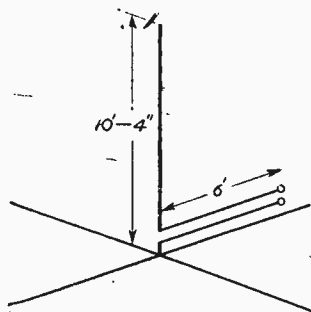

Fig. 4.—A 21 Mc/s ground plane and feeder system may also be resonated on three bands. For 14 Mc/s use series tuning; for 21 Mc/s use series or parallel tuning; for 28 Mc/s use parallel tuning.

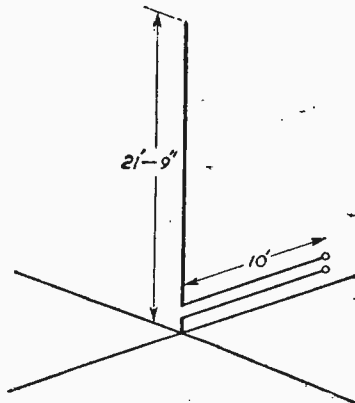

Fig. 6.—An extended radiator ground plane giving four-band operation. For 7 Mc/s use series tuning; for 14 Mc/s use parallel tuning; for 21 Mc/s use series tuning; for 28 Mc/s use parallel tuning.

loading can be improved by utilising both condensers instead of one.

### Dimensions

We must now turn to the question of aerial dimensions that will permit "multiband" operation without too much complication or loss of efficiency. One simple idea is to utilise a 10-metre ground plane, and to use enough length of 300 ohm resonant feeder to enable it to be "loaded up" on both 21 Mc/s and 14 Mc/s as well. This is illustrated in Fig. 3. Note that the aerial dimensions are only approximate for illustration purposes, and should be calculated from the Fig. 1 dimensions for 10-metre operation. With 8ft. of 300 ohm twin feeder, this can be resonated upon the three H.F. DX bands. For 28 Mc/s operation, parallel feeding at the aerial tuning unit end will be needed, while series tuning will be needed upon both 14 Mc/s and 21 Mc/s.

However, an eight foot vertical is not the best form of radiator for 14 and 21 Mc/s operation, although perfectly satisfactory for 10-metre operation. Using the principles previously described, we can lengthen the radiator and radials at the expense of feeder length. Fig. 4 illustrates that a ground plane designed for 21 Mc/s operation, and fed with 6 ft. of resonant

tuning on 21 Mc/s, and series or parallel tuning on 28 Mc/s. It should be noted, of course, that the feeder lengths quoted are the minimum length. In general they may be extended by multiples of quarter wavelengths at 14 Mc/s to enable longer feed lengths to be obtained. Thus as a quarter wave at 14 Mc/s is 8½ ft. with an allowance for propagation on twin 300 ohm cable, we should extend the feeders in multiples of 7 ft. If air-spaced cable is used, extend by multiples of 8½ ft. Note that each quarter-wave extension will invert the specified tuning system for 14 Mc/s operation. Thus where series tuning is used, a further quarter-wave of cable added will mean that parallel tuning must be used. Yet a further quarter-wave of feeder (i.e., a total additional half wavelength) will entail series tuning, and so on. However, if the "Universal" aerial tuner circuit of Fig. 2 is used, this occasions no difficulty, as it is easy to tune up by adjustments of both condensers to suit almost any aerial or feeder impedance. Therefore the feeders may be cut to the nearest convenient multiple of a quarter wavelength at 14 Mc/s, and pruned slightly if necessary to ensure that good loading is obtainable on each band.

### Loading

It should be noted that all these ground planes may

be loaded up on the lower frequency bands by the use of series tuning at the aerial tuner. Thus a 10-metre ground plane may be even resonated upon topband by using series tuning at the aerial tuner. However, short ground planes will not be very efficient radiators. The "extended radiator" ground plane of Fig. 6 designed for dimension suitable for 11.7 Mc/s will, however, be quite efficient upon 7 Mc/s, and will thus

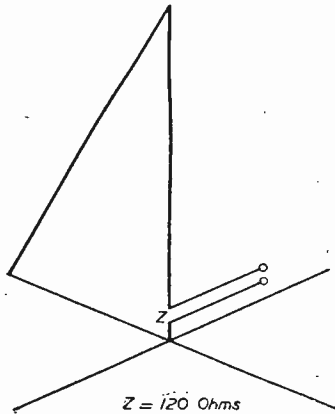

Fig. 7.—The feed impedance of the ground plane may be increased and the bandwidth increased by "fan folding."

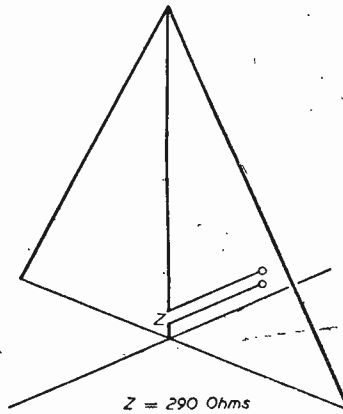

Fig. 8.—Further folding further increases the bandwidth and feed impedance rendering the antenna less frequency sensitive.

make a passable five-band vertical radiating system.

It can, of course, be series resonated upon 3.5 Mc/s and even upon topband, but will not be the most desirable aerial for topband use!

The question of multi-band operation of ground planes thus opened up by the above examples, leads to the query as to whether the basic ground plane concept cannot be inherently "broadbanded" by suitable techniques. This is indeed pertinent as a

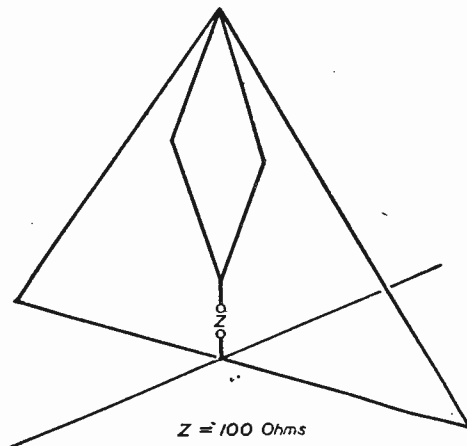

Fig. 9.—A combination of folding and the use of a fattened radiator element. The "fat" skeleton wire radiator reduces the feed impedance, but still further increases the bandwidth. Many further variations are possible.

thin vertical radiator tends to be a somewhat sharply-tuned device, so that on any given band it is likely to be efficient on only a small bandwidth centred upon the design frequency, or alternatively, to require retuning at the aerial tuning network whenever the transmitter frequency is shifted slightly. Also, of course, the fact that the basic ground plane has a low feed impedance means that feeder losses and aerial tuner losses are proportionately accentuated, so that they should be of low-loss construction. The higher losses of coaxial cable compared with air-spaced or twin lead 300-ohm moulded cable, is one reason why the "classical" coaxial-fed ground plane users do not get good performance on other bands, and is why tuned open feeders must be used to get good multi-band performance.

One broadbanding technique that offers interest for use in multiband ground plane vertical systems is the use of folding. The centre radiator of a ground plane may, of course, be folded in a similar manner to the usual folded dipole elements. However, even greater bandwidths for the multi-band systems may be obtained by "fan" type folded elements. Thus, in Fig. 7 we see the simple ground plane with its feed impedance of 30 ohms. Fig. 8 illustrates how we may include a "fan fold" to quadruple the feed impedance to 120 ohms. This merely entails running a wire from the radiator apex to the extremity of one ground radial. Note, however, that the diameter of the sloping wire from radiator apex to radial must be of the same diameter as the radiator to give a quadruple step-up of impedance. However, even a thin wire will assist in the broadbanding process.

The fan folding can be carried a stage further by running a second wire to an opposing radial as shown in Fig. 9. This gives a ninefold increase of feed impedance over a simple ground plane, so that the feed impedance becomes 270 ohms, which may be directly fed as an impedance match into 300-ohm moulded twin-feeder cable with negligible standing wave ratio, at any rate, at the fundamental design frequency, for these feed impedances refer, of course, to the fundamental design frequency and not to harmonically related frequencies. However, upon the harmonics resonant feeder operation will occur, at any rate with the simple folded aeriels.

#### Increased Bandwidth

Broadbanding with progressive folding increases the bandwidth rapidly and, in fact, it is possible with further folding to cover up to a four-to-one frequency range with a single aerial. This means not just harmonic coverage, i.e., operation upon harmonics of the design frequency, but continuous frequency coverage, so that the aerial is actually usable on any frequency over a four-to-one bandwidth. This, of course, is broadbanding with a vengeance. One method is to "fatten" the centre radiator by using two wires in a thin diamond-shaped

(Concluded on page 426)

# AN INEXPENSIVE TEST METER

By H. Hodgson



A view of the finished test meter.

WHILST a multi-range test meter is one of the most useful pieces of equipment a radio enthusiast can have, it is a fact that a high percentage of radio amateurs do not possess such an instrument. However, a relatively inexpensive test

meter can be constructed, with accuracy as great as the constructor wishes to make it.

The following details and diagrams were designed around the basic meter unit of the "Triplet Model 666H," some of which are now available and advertised in PRACTICAL WIRELESS, Feb., 1956. Of course, any moving coil movement can be used, but if the full-scale deflection current differs from 400 micro-amperes the values of certain resistors in the circuit must be altered.

### Range Selector Switch

One 4-pole, 12-way Yaxley type switch is used, the rear wafer being modified to provide for shorting the positive and negative terminals of the test meter on the 0-300Ω range. It should be noted that this range is a "shunt type" resistance meter, the unknown resistance being placed across the meter movement in parallel, thereby reducing the flow of current through the meter coil according to the value of the unknown.

The original Triplet meters have a 14-position

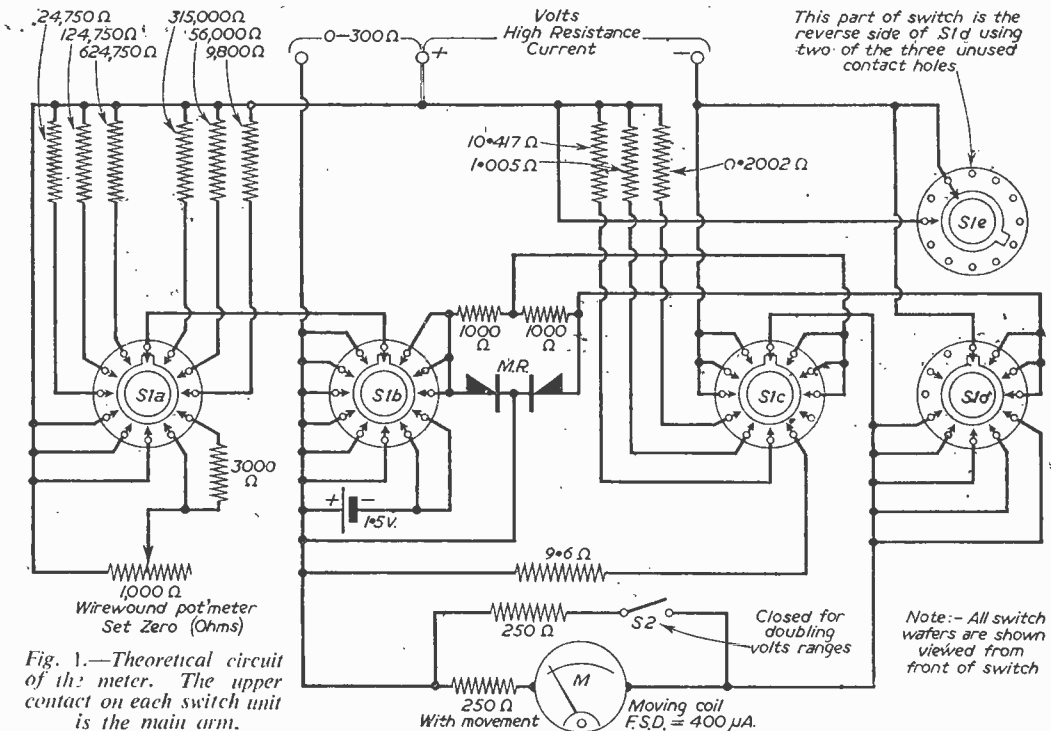
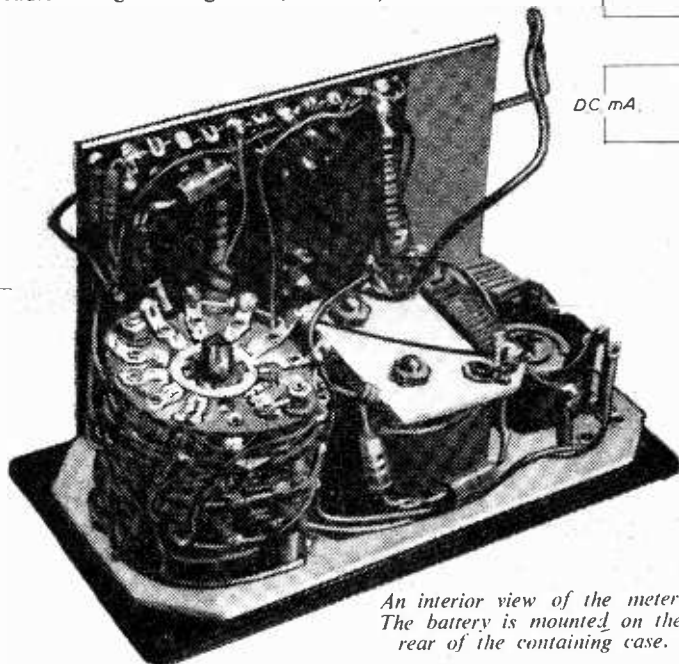

Fig. 1.—Theoretical circuit of the meter. The upper contact on each switch unit is the main arm.

switch, but as this was unobtainable it was decided to eliminate the 1,000-5,000 volts ranges, A.C. and D.C., thereby permitting the use of the more conventional 12-way type. One seldom encounters radio voltages as high as 1,000 volts, and for this



An interior view of the meter. The battery is mounted on the rear of the containing case.

reason it was decided that these were the best ranges to eliminate. However, as this left the instrument with a maximum range of 250 volts, a meter shunt (of equal value to the meter coil resistance) was fitted, so doubling the voltage readings on every range, with the switch S2 closed.

The Multipliers are 1/2 watt carbon type, the actual values being made up of standard values which are high or low on tolerance as required, e.g., 624,750Ω was a 680 KΩ 20 per cent., which was lower than its stated value, but within its tolerance of 20 per cent.

As the shunts must be accurate they are made up of Eureka and enamelled copper wire on paxolin strips with solder tags. Details are given in the accompanying table.

R.	Wire	Length
10.417Ω	38 Eureka	15in.
1.005Ω	38 Enamelled	42 3/4 in.
0.2002Ω	38 Enamelled	8 7/8 in.
9.6Ω	38 Eureka	13 13/16 in.

**Meter Rectifier**

The Triplet meter can be obtained complete with rectifier,

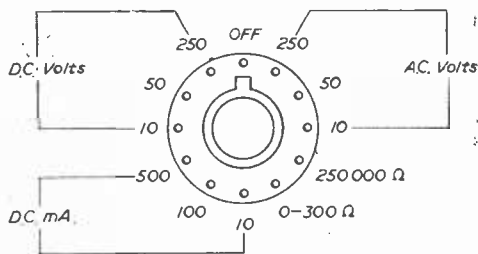

Fig. 3.—Switch positions.

but any 1 milliamp meter rectifier can be used.

**Construction**

The diagram shows the general layout of the chassis and components. It is important that the wiring should be kept as short as possible, especially for the shunt circuit wiring, as this will affect the accuracy of the instrument.

The chassis is cut from 18 s.w.g. sheet aluminium, and is fixed to the meter unit by means of the three screws holding the meter unit together. The test sockets are normal aerial and earth sockets used in radio receivers. The internal battery is of the U.2 cell, 1.5 volt type. The 1,000-5,000 volt test socket is utilised for mounting the toggle switch S2. The range markings on the front of the panel should be amended to correspond with the new switch positions.

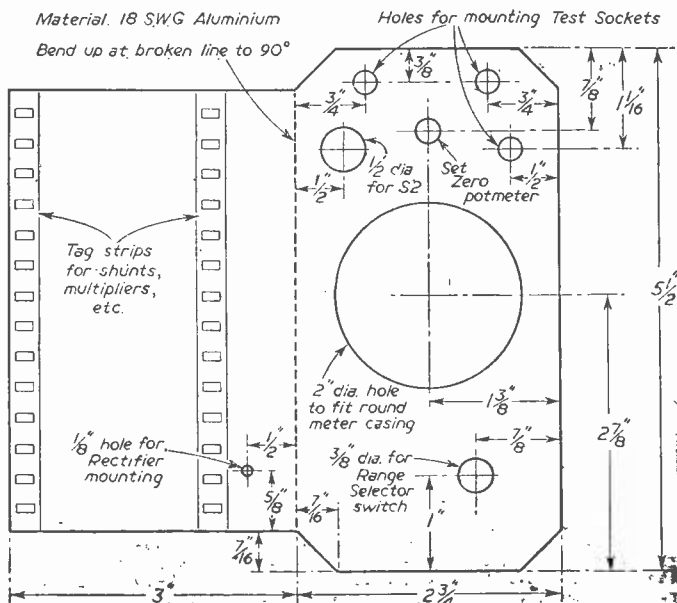

Fig. 2.—Details of the chassis.



**C.R.T. ISOLATION TRANSFORMER**

Type A. Low leakage windings. Ratio 1:1.25 giving a 25% boost on secondary. 2 v., 10/6; 4 v., 10/8; 6.3 v., 10/6; 10.5 v., 10/6; 13.3 v., 10/6.  
Ditto with mains primaries, 12/6 each.

Type B. Mains Input 220/240 volts. Multi Output 2, 4, 6.3, 7.5, 10 and 13 volts. Input has two taps which increase output volts by 25% and 50% respectively. Low capacity, suitable for most Cathode Ray Tubes. With Tag Panel. 21/- each.

Type C. Low capacity wound transformer for use with 2 volt tubes with falling emission. Input 220/240 volts. Output 2-21-21-2-3 volts at 2 amps. With Tag Panel. 17/6 each.  
**NOTE.**—It is essential to use mains primary types with T.V. receivers having series-connected heaters.

**TRIMMERS.** Ceramic. 30, 50, 70 pf., 8d. 100 pf. 150 pf., 1/3; 250 pf., 1/6; 500 pf., 750 pf., 1/9.  
**RESISTORS.** All values. 10 ohms to 10 meg., 1 w., 4d.; 1 w., 6d.; 1 w., 8d.; 2 w., 1/-.

**HIGH STABILITY.** 1 w., 1%; 2 w., Preferred values 170 ohms to 10 meg.  
**5 watt WIRE-WOUND RESISTORS** (1/3) 10 watt—25 ohms—10,000 ohms..... (2) 15,000 ohms—50,000 ohms. 5 w., 1/9; 10 w., 2/3.  
**KNOBBS.** GOLD ENGRAVED.—Walnut or Ivory. Fin. diam., 1/8 each. Not engraved, 1/- each.

**19 IN. DIAM. RECORDING TAPE**

1,250 ft. on standard fitting 7" Plastic reels. Brand new, boxed, 17/6.  
Spools 5" metal 1/6, 7" plastic 4/3.

**O.P. TRANSFORMERS.** Heavy Duty 50 mA., 4/6. Multitap, push-pull, 6V. Tapped solid pentode, 3/6.  
**L.F. CHOKES** 15/10 H. 60/65 mA., 5/-; 10 H. 120 mA., 10/6; 15 H. 150 mA., 12/6.

**MAINS TRANS.** 250-0-250, 80 mA., 6.3 v. tapped 4v., 4.4 v., 5 v. tapped 3 v., 2.4 d., 250-0-250, 21/-.  
**HEATER TRANS.** Tapped prim., 200/250 v., 6.3 v. 11 amp., 7/6; tapped sec., 2, 4, 6.3 v., 11 amp., 8/6  
**VOB97 TESTED FULL PICTURE.** 22.

**COOPER PLATED AERIAL RODS.** 1/2" x 12in. push fitting, 3/- (log. to & p. 1).  
**ALADDIN FORMERS** and core, 1/2", 8d.; 1 in., 10d. 1/2 in. FORMERS with Cans and Core. 1/2 in. sq. x 1 1/2 in. and 1/2 in. sq. x 2 1/2 in., 2/- ea.

**TYRAN.** Midret Soldering Iron. 200/220 v. or 220/250 v., 14 1/2 in. Solon Midget Iron, 24/-.  
**MIKE TRANS.** Ratio 50:1, 3/6 ea.

**MAJNS DROPPERS.** 3 x 1 1/2 in. Adj. Sliders, 3/6. 750 ohms, 4/3. .2 amp., 1,000 ohms, 4/3.  
**LINE COIL.** .3 amp., 60 ohms per foot, .2 amp., 100 ohms per foot, 1/6; 60 ohms per foot, 3-way, 7d. per foot.

**LOUDSPEAKERS F.M. 3 OHM.** 5in. Goodmans, 17/6. 7in. x 4in. Goodmans, 21/6. 3 1/2 in. square Elac 21/-.  
8in. Elac, 22/-.  
6 1/2 in. Goodmans, 18/6. 10in. K. & A. 30/-.

**TYRAN.** 12in. Plessey 83.-  
**S.M.E. 2.5 k.** or 2 k. held, tapped O.P. trans., 24/6.  
**CRYSTAL DIODE.** (G.E.C.), 2/-.  
**CRYSTAL BOX.** EG31, 4/-; 40 Circuits for Germanium Diodes, 3/6.  
**HIGH RESISTANCE PHONES.** 4,000 ohms, 27/6 pr.

**CRYSTAL MIKE INSERT** by Acos, precision engineered. Size only 11 x 3 1/2 in. Bargain Price 6/6. No transformer required.

**SWITCH CLEANER.** Fluid, squirt spout, 4/3 tin.  
**TWIN GANG TUNING CONDENSERS.** .0005 mfd. midgap with trimmers, 8/6; .375 pf. midret, less trimmers, 6/6. .0005 Standard size with trimmers and test, 9/-; less trimmers, 8/-; ditto, solid, 2/6.  
**SPEAKER FRET.** Woven Plastic T.V.GAN. Walnut tone, 12in. wide, 2/- per foot. Expanded metal, Gold 9j x 12in., Silver, 15 1/2 in. x 9 1/2 in., 2/- each.

**VALVES**

A SMALL SELECTION FROM OUR STOCKS				
All boxed	1/6	New & Guaranteed		
8/3	5/6	EA30	6/6	10/8
18/5	6/8	54	6AL5	5/3
17/1	9/2	2 6	6J5	12A77
18/5	EF50	2X2	6K6	EBCA1
38/1	EF40	E1145	6K74	EP490
2V4	SP41	EB34	EB91	ECH35
6/4	SP41	EB34	EB91	ECL80
6AM6	EF91	3/6	HVR2	ECH42
6AT6		3/6	(near)	EF41
6J7	7/6	6H6M		EF41
6K8			7/6	EL41
6N17	6BE6	7/6	EL32	EZ40
6V6T	6BW6	6V6G	HEN2A	KT33C
69N0T	6F6	6X5	VR25	MU14
EB33	6K7GT	807	U22	PL51
EF10	6K7M	EF39	V223	PL41
Sylv. Rect.				EV51
EF11	12K8, 12Q7, 12K7, 35L6, 36Z4			6Q7
	Special Price—87/6—The Set.			X79

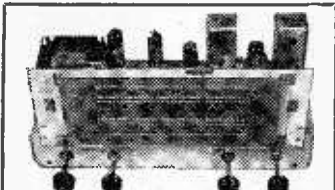

**ALL WAVE RADIOGRAM CHASSIS**

THREE WAVEBANDS FIVE VALVES  
S.W. 16 m.—50 m. LATEST MILDARD  
M.W. 200 m.—350 m. ECH42, EF41, EBC41,  
L.W. 800 m.—2,000 m. EL41, EZ40.

12 month Guarantee.  
A.C. 200/250 v., 4-way Switch, Short-Medium-Long-Gran. A.T.C. and Negative feedback.  
4.2 watts. Chassis 131 x 51 x 2 1/2 in. Glass Dial 10 x 4 1/2 in. Horizontal or Vertical available.  
2 Pilot Lamps, Four Knobs, Walnut or Ivory. Aligned and calibrated. Chassis isolated from mains.

**10 gs.** Carr. & Ins., 4/6.  
**MATCHED SPEAKERS FOR ABOVE CHASSIS**  
19in., 19/6; 10in., 25/-; 12in., 30/-.

**\* R.C.S. SCOOP \***

Collaro Auto-changer RC531 for 78 r.p.m. 10in. and 12in. records. Brand new in maker's boxes! High impedance lightweight Pick-up with sapphire needle, will suit any Amplifier or Radio. Less than half price.  
**£5.19.6.** carr. and ins., 5/6.



**£7-19-6** Post Free.

Brand new Plessey 3-speed Autochanger Mixer Unit for 7, 10 and 12in. Records. Twin Hi-Fi Xtal Head with Dupoint sapphire stylus. Plays 4,000 records. Spring mounting. Base-board required 151 x 12in. Height 5 1/2 in. Depth 2in. Super Quality. 200/250 v. A.C.

Walnut Veneered Playing Desk cut out ready for Plessey, only sold complete with Changer 10/6 extra.

**AMPLION.** 3-speed Single Record unit with Acos 37 Turnover Head, each Sapphire Stylus plays 2,000 records. Starting Switch Automatically places Pick-up on records. Tin, 10in. or 12in. Auto Stop. Baseplate 12 x 8 1/2 in. Height 2 1/2 in. Depth 1 1/2 in. Price £7.15.6, post free.

**B.S.R. MONARCH.** 3-speed Motor and Turntable with selecting switch for 33, 45 and 78 r.p.m. records. 100-120 v. and 200-250 v. A.C. 50 cps. Also B.S.R. MONARCH Lightweight Pick-up with Acos Xtal turnover head, separate Sapphire stylus for L.P. and standard records. SPECIAL OFFER, THE TWO: £4.15.6, post 2/6.

**T.V. PRE-AMP.** (MEMICHAEL). Tunable Channels 1 to 5. (Will Amplify Output of your Band 3 Converter.) Midget size, High Gain Fringe Model, B.V.A. Valve. Full Instructions Ready for use. (H.T. 200 v., L.T. 6.3 v., .3 amp. mains.) BRAND NEW. 25/- each. SPECIAL MAINS POWER PACK for above, 25/- extra.

**F.M. TUNER COIL KIT.** 22/6. H.F. coil, Aerial coil, Oscillator coil, two I.P. Transformers 10.7 Mc/s. Detector transformer and heater choke. With circuit and component list, using four 6AM6. Chassis and Dial, 19/6.

**TELETRON BAND III CONVERTER**

For London, Midland and Northern Transmissions.  
Suitable all T.V. makes. T.R.F. or Superhet. Ready wound coils, two EF50 valves, all components, punched chassis, circuit diagram, wiring plans. COMPLETE KIT for mains operation 200-250 v. A.C. £3.10.0.

As ABOVE less POWER PACK. Requires 200 v. 20 mA. H.T. 65 v., 6.4 A. L.T. £2.5.0.  
Mains Transformer to suit, 10/6.  
Mins. Westinghouse or A.C. Rect. diff. Spool, ... 8/6  
B.C.C./I.T.A. cross-over unit, ... 7/6  
Punched and drilled chassis, ... 3/9  
Larger chassis for Mains Model, ... 8/-  
Teletron Cabinet with plans, ... 15/-  
Full plans and circuit details, ... 6d.

**Volume Controls: 80 ohm COAX**

10in. spindles. Guaranteed. Semi-air spaced Polystyrene insulated. 1in. dia. 10,000 ohms to 2 Meg. Stranded core. 10 Sw. S.P.S.W. D.P. Sw. Losses cut 50%  
3 - 4 - 49 STANBARD 8d. yd.  
Ext. Sutr. Type, 3 - 4 - 11d. Coax.

**SOX PLUGS** ... 1 - DOUBLE SOCKET ... 1/3  
**SOCKETS** ... 1 - OUTLET SOCKETS ... 4/6  
**BALANCED TWIN FEEDER**, yd. 6d. 80 or 300 ohms. DITTO SCREENED per yd. 1 - 80 ohms only. WIRE-WOUND POTS, 3 WATT. Pre-Set Min. T.V. Type. All values 25 ohms to 30 K., 3/- ea. 50 K., 4/- (Carbon 30 K. to 2 m., 3/-).

**WIRE-WOUND 4 WATT** Pots, 2 1/2 in. Spindle. Values, 100 ohms to 50 K., 5/6; 100 K., 6/6. CONDENSERS. New stock. .001 mfd., 7 K.V. T.C.C., 5/6. Ditto, 20 K.V., 9/6; 100 pf. to 500 pf. Micas, 6d.; .1 ufarad 500 v. 501 to .01 mfd., 8d.; .05 ufarad, 1/-; .25, 1/6; .1 ufarad, 1/350 v., 9d.; 1/600 v., 1/3; .1 mfd. 2,500 volts, 6/6.

**CERAMIC CONDS.** 500 v., .3 pf. to .01 mfd., 10d. SILVER MICA CONDENSERS. 100v., 5 pf. to 500 pf., 1/-; 600 pf. to 3,000 pf., 1/3. DITTO 1 1/2 pf. to 500 pf., 1/9; 515 pf. to 1,000 pf., 2/-.

**I.F. TRANSFORMERS 7/6 pair**  
485 Kc/s Slog tuning Miniature Can, 2 1/2 in. x 1 1/2 in. High Q and good bandwidth. By Pye Radio. Data sheet supplied.

**NEW ELECTROLYTICS. FAMOUS MAKES**

TUBULAR	TUBULAR	CAN TYPES
1/275 v. 2	100 25 v. 2	8 - 16,500 v. 5/8
4/450 v. 2.3	8 - 4,300 v. 4/6	16 - 10,450 v. 5/6
4/450 v. 2/7	16 - 10,300 v.	16 - 23,250 v. 4/6
8/450 v. 2/9	6 - 32 - 32,350 v. 4/6	
8/500 v. 2/3	CAN TYPES	32 - 32,450 v. 6/6
16/450 v. 3/6	Oilps	3d. 64 - 120,275 v. 7/6
16/500 v. 4	Oilps	3d. 64 - 120,350 v. 11/6
32/500 v. 5/6	32 Oilps	3d. 32 - 350 v. 1/6
25/25 v. 9	60 350 v. 5/6	1 - 100 - 200,275 v. 12/6
50/25 v. 1/8	50 350 v. 5/6	1 - 1,000 - 1,000.0 v. 6/6
50/50 v. 2	8 - 16 450 v. 5	5 - 6/6
50/50 v. 2	8 - 16 450 v. 5	5 - 6/6
Screen Base Type 212, 8 500 v. 3	16 500 v. 4	
<b>GENERAL RECTIFIERS. E.H.T. TYPE KLY-ROCK VOLTAGES.</b> K2 2 kv. 4/3; K3 3 kv. 5/2; K4 4 kv. 6/3; K5 5 kv. 7/3; K6 6 kv. 8/3; K7 7 kv. 9/3; K8 8 kv. 10/3; K9 9 kv. 11/3; K10 10 kv. 12/3; K11 11 kv. 13/3; K12 12 kv. 14/3; K13 13 kv. 15/3; K14 14 kv. 16/3; K15 15 kv. 17/3; K16 16 kv. 18/3; K17 17 kv. 19/3; K18 18 kv. 20/3; K19 19 kv. 21/3; K20 20 kv. 22/3.		

**ALUMINIUM CHASSIS.** 18 swg. un drilled. With 4 sides, riveted corners and lattice fixing holes, 2 1/2 in. sides, 7 x 4 in., 4/6; 3 x 6 in., 5/9; 1 1/2 x 7 1/2 in., 6/9; 1 1/2 x 6 in., 8/6; 1 1/2 x 4 in., 10/6; 1 1/2 x 1 1/2 in., 12/6; 1 1/2 x 1 1/2 in., 16/6.

**FULL WAVE BRIDGE SELENIUM RECTIFIERS.** 2, 6 or 12 v., 11 amp., 29/6; 2, 6 or 12 v., 4 amp., 17/6.  
**CHARGER TRANSFORMERS.** 2-tapped iron core, 250 v. for charging at 2, 6 or 12 v., 11 amp., 18/6; 4 amp., 21/-.

**ALL BERNARDS books in stock.**  
**VALVE MANUALS I & II.** 5/- ea. part.  
**VALVE AND TV TUBE EQUIVALENTS** book, 5/-.  
**ACID HYDROMETER.** New Ex. Gun, Unbreakable. Packed in metal case 7 x 1 1/2 in. dia., 4/6.  
**WAVECHANGE SWITCHES.**  
5 p. 4-way, 2 waler, long spindle ... 6/6  
2 p. 2-way, 3 p. 2-way, short spindle ... 2/6  
2 p. 6-way, 4 p. 2-way, 4 p. 3-way, long spindle ... 3/6  
3 p. 4-way, 1 p. 12-way, long spindle ... 3/6  
**VALVE HOLDERS.** Pax. Int. Oct. 4d., EF50 EA50, 6d., B12A, CRT, 1 1/2. Engr. and Amer. 4, 5, 6, 7 and 9 pin, 1/-.  
**MOULDED MOUNTS** and Int. Oct. 6d.  
B7G, B8A, B9G, B9A, 9d., B7G with can 1/6.  
VC97 2/6, B9A with can 2/6.  
**CERAMIC, EF50, B7G, B9A,** Int. Oct. 1/-, B7G with can 1/9.  
**BLACK CRACKLE PAINT,** air drying, 3/- tin.

We have no connection with any other firm. Please address all Mail Orders correctly as below.  
**RADIO COMPONENT SPECIALISTS 307 WHITEHORSE RD., WEST CROYDON**  
OPEN ALL DAY—(Wed. 1 p.m.) 10 page list 3d.  
Tel. THO 1665, Buses 133 or 69 pass door. 48-hour postal Service. P. & P., 1/- £2 orders post free. (Export Extra.) C.O.D. Service 1/6

# JACKSON

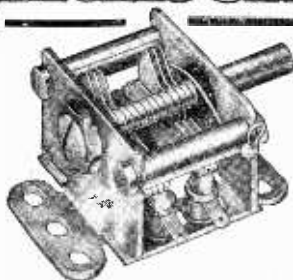

## TYPE U.101/S.S.

Cat. No. 5095

Chassis Mounting Gang Condenser with Split-Stators, Ceramic Insulation. Cadmium Plated Chassis. Silver Plated Brass Rotor and Stator. Rotor earthed to Frame. Capacities available each half :- 3-10 pf., 3.8-27 pf., 4-35 pf. or 4.43 pf. Price 10/9 each.

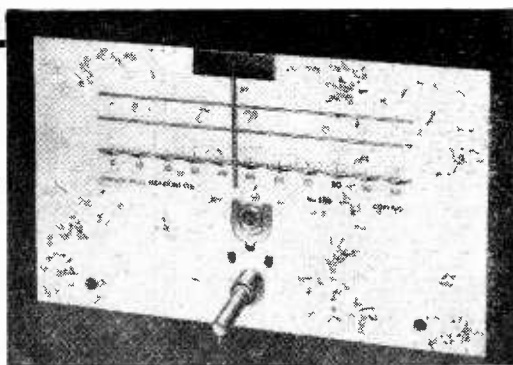

## S.L.16 DRIVE

RETAIL PRICE 11/6

A general purpose slide rule Drive for F.M./V.H.F. Units, short-wave converters, etc. Printed in three colours on aluminium, with a 0-100 scale and provision is made for individual calibrations. Travel of pointer 4 3/8 in. Scale Plate 7 in. x 4 1/2 in. Scale aperture 5 1/2 in. x 1 1/2 in.

## S.L.15 DRIVE

RETAIL PRICE 25/6

A complete kit of parts for the construction of the Jackson S.L.15 Drive, scale calibrated for the F.M./V.H.F. Band.



Write for further details :

**JACKSON BROS. (London) LTD. KINGSWAY · WADDON · SURREY**

Telephone : CR0ydon 2754-5.

Telegrams : Walfico, Souphone, London.

## FREE To AMBITIOUS ENGINEERS!

This 144-page Book

Have you sent for your copy ?

**'ENGINEERING OPPORTUNITIES'** is a highly informative guide to the best-paid Engineering posts. It tells you how you can quickly prepare at home on "NO PASS—NO FEE" terms for a recognised engineering qualification, outlines the widest range of modern Home-Study Courses in all branches of Engineering and explains the benefits of our Employment Dept. If you're earning less than £15 a week you cannot afford to miss reading this unique book. Send for your copy to-day—FREE.

### WHICH IS YOUR PET SUBJECT ?

- Mechanical Eng.
- Electrical Eng.
- Civil Engineering
- Radio Engineering
- Automobile Eng.
- Aeronautical Eng.
- Production Eng.
- Building, Plastics, Draughtsmanship
- Television, etc.

### GET SOME LETTERS AFTER YOUR NAME!

- A.M.I.Mech.E.
- A.M.I.C.E.
- A.M.I.P.E.
- A.M.I.M.I.
- L.I.O.B.
- A.F.R.Ae.S.
- B.Sc.
- A.M.Brit.I.R.E.
- CITY & GUILDS
- GEN. CERT. OF EDUCATION
- etc., etc.

**FREE COUPON**  
Please send me your FREE 144-page 'ENGINEERING OPPORTUNITIES'

NAME .....

ADDRESS .....

Subject or Exam that interests me .....

British Institute of Engineering Technology, 109B, Collyer house, 28-31, Wright's Lane, Kensington, W.8.

# BIET

## CONSTRUCTORS build these at DOWN-TO-EARTH PRICES

PERSONAL PORTABLE RADIO **30/-**

This little set was designed to give you a real personal portable radio that you can enjoy anywhere without disturbing others. Use it on camping trips, in bed, in your office, or just anywhere. Send 2/- for layout, Wiring diagram and Components Price List.



## 1v SHORT-WAVE RADIO

- ★ Covers 10-100 metres.
- ★ World-wide reception.
- ★ Low drain valve.
- ★ Picture diagram and instructions for beginners.
- ★ Assembling time 1 hr.

**30/-**

This 1 valve S.W. receiver can be built from our list of components for 30/-, including valve and 1 coil covering 20-40 metres. Provision is made to increase to 2 or 3 valves if required. All components can be purchased separately and are colour-coded so that the beginner can build this set quite easily. Send 2/- for specification, wiring diagram, layout and price list to —

**R.C.S. PRODUCTS (RADIO) LTD**  
11 OLIVER ROAD, LONDON, E.17. Mail order only.

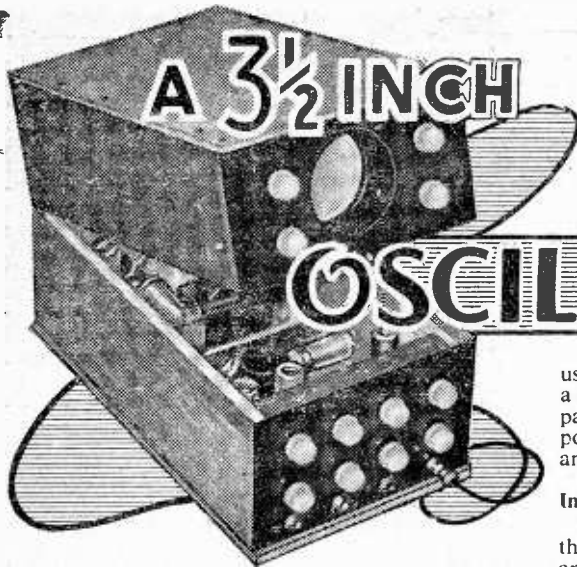

## A Novel Test Set Built up From Three Units and Utilising a 3 1/2 in. Tube

By R. Couvcla

(Concluded from page 325 July issue)

# OSCILLOSCOPE

use a VCR97. The only alterations required would be a larger cabinet and an EHT of 2,000 volts, as compared with 900 in this case. The basic form of the power pack would be unaltered, and the timebase and amplifier unit would require no modification.

### Interconnection of Chassis

The timebase and amplifier unit is connected to the power pack by means of a 10-way Bulgin plug and socket. The type to be used has thin prongs fitted to the fixed section, the socket being portable. If this precaution is not observed, and the unit switched on with this plug out, H.T. will appear on an exposed prong, which could be dangerous.

The cable from this plug carries H.T. and E, two L.T. leads (heater being centre tapped) and two each X and Y leads.

Provided these leads are twisted in pairs, no hum will be picked up on the plates.

The X, Y leads are taken direct through the

**T**HE slider of the two 1 MΩ controls should be adjusted to ± 150 volts with respect to earth.

Two plates are therefore connected direct to these sliders, one each of X and Y. The other two plates are taken to earth (anode) via 1 MΩ fixed resistors.

The tube holder is mounted on the cabinet by drilling two or more fixing holes through it, fixing with countersunk wood screws.

Components required for this part of the circuit were given on page 326 of last month's issue.

The control potentiometers should be mounted reasonably close to the base of the tube, controlled via bakelite extension spindles which extend through the front of the cabinet.

### 6in. Version

It will be noticed that the tube used is interchangeable in base with the popular VCR97. In actual fact the unit could probably be easily adapted to

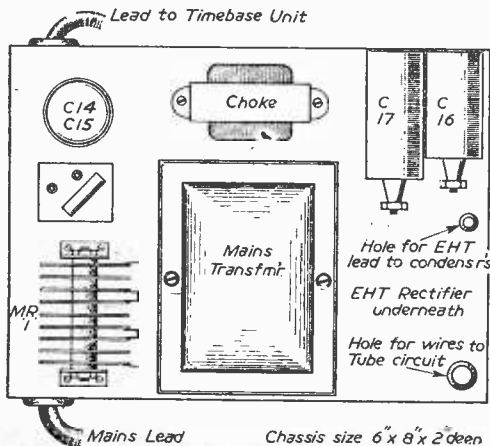

Fig. 12.—Layout of the main section.

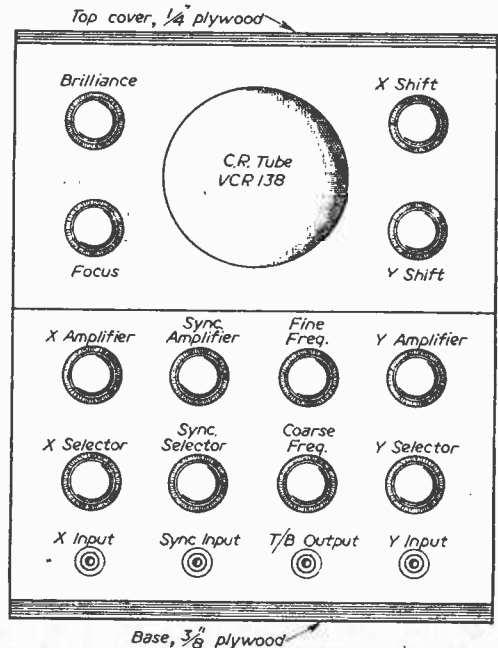

Fig. 13.—Details of the controls.

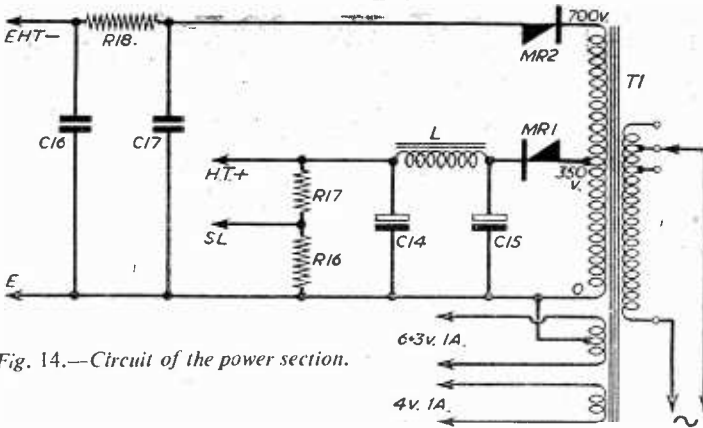
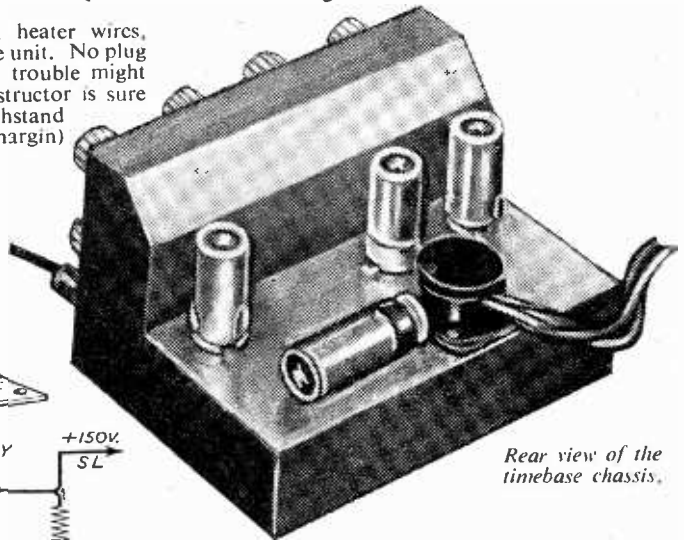
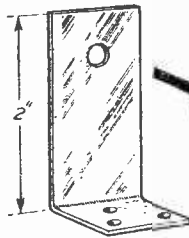

Fig. 14.—Circuit of the power section.

power pack, where they join 4 volt heater wires, earth and EHT leads, to go to the tube unit. No plug was used here, as it was thought that trouble might ensue with the EHT, but if the constructor is sure that his plug and socket will withstand 1,000 volts (preferably with a safety margin) one could be used.

Fig. 15.—Details of the brackets used in the tube unit section of the oscilloscope. (See Figs. 1 and 2 of last month's issue.)



Rear view of the timebase chassis.

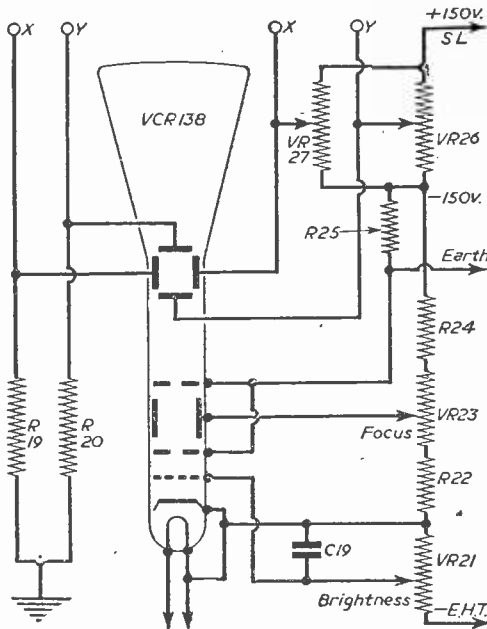

constructor, but, if it is desired, pointer knobs may be used and a sheet of paper pasted on the panel to indicate the positions of the switches, etc.

It should be noted that in Fig. 9 condenser C2 should be taken to earth, not to the junction of R3, 4 and 5.

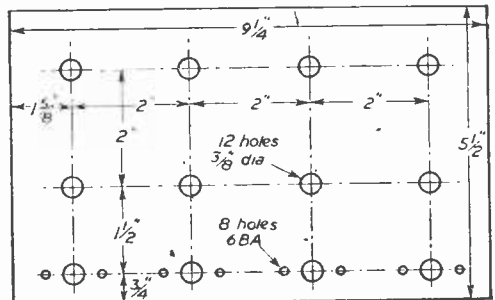

Fig. 16 (left).—The tube unit circuit. Fig. 17 (above).—Drilling data for the front control panel.

Conclusion .

Doubts may arise concerning the wisdom of using the specified lines between amplifiers and tube if the timebase is to be used at 200 kc/s, but in actual fact there is no interference between the plates at this frequency, the main problem being attenuation due to self capacity in the line, but even this is not troublesome.

From the photographs it will be noticed that the knobs employed were unidentified on the panel. This was adopted purely for convenience and because the prototype is intended only for use by the

# A TRANSISTOR DIODE

# Portable

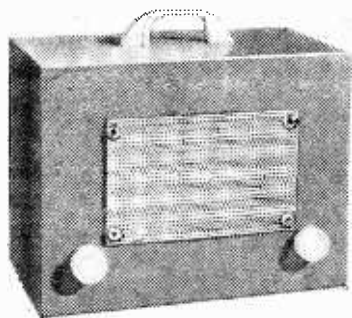

A USEFUL RECEIVER WITH MANY APPLICATIONS

By R. V. Moore

THE small size of transistors, the low power requirements and the few components required compared with valve circuits lead inevitably to the development of midget receivers. However, apart from the novelty, there can be no point in producing such a receiver unless complete portability is desired, and achieved at reasonable cost. A midget set requires a midget speaker, and transistors are not at their best when working these. Furthermore, to eliminate aerial and earth at least two H.F. stages in a straight circuit are needed for only moderate results with present available types. Otherwise, an even more costly superheterodyne circuit is required. A proprietary set recently launched has 8 transistors!

After many hours of experimenting and testing it seemed to be time to produce more tangible results in the shape of a finished receiver with cabinet. Although designed primarily for the bedside this little receiver will obviously have other applications, and it should be noted that it is designed for use with an aerial and earth. For bedside use the aerial was 50 feet of plastic covered aerial wire fastened to the picture moulding by insulated staples. The earth wire was taken to the cold water inlet in the cylinder cupboard. The locality required long wave tuning for the Light programme. The power supply was to be 9 volts, and the size of the speaker limited to 6in. These considerations, and the desire to keep costs down by using a minimum of transistors, governed the choice of circuit.

### The Circuit

The circuit, as shown in Fig. 1, consists of a diode detector stage followed by two stages of L.F. amplification using junction transistors. To obtain maximum volume from such a combination transformer coupling is required. Resistance-capacity coupling gives less volume. Quality may be somewhat better, but it takes a very discriminating ear to notice any difference. With resistance-capacity coupling there may be sufficient volume for the listener from a circuit employing a diode and two junction transistors if an 8 in. speaker is used, or if the listener is situated in a good reception area even with a 6in. speaker. For readers who wish to try this an alternative circuit is given in Fig. 3 (see notes later).

### The Detector Stage

This is a simple crystal diode feeder employing two tuned circuits. The coils are R.E.P. dual-wave crystal coils chosen for their modest price (2s. 6d.) and reasonable efficiency. No single dual-wave coil was found to be satisfactory such that a fair compromise between sensitivity and selectivity could be attained. The coils are pretuned by trimmers C1, C2, C3, C4, each 250 pF. Station selection is by a double-pole on/off switch, SW1, giving medium-wave Home service or long-wave Light programme. The value of the coupling condenser, C5, is 40 pF, but any value between 10 and 100 pF may be tried.

Any diode may be tried but preferably a good one such as the GD3 should be used. Results with cheap

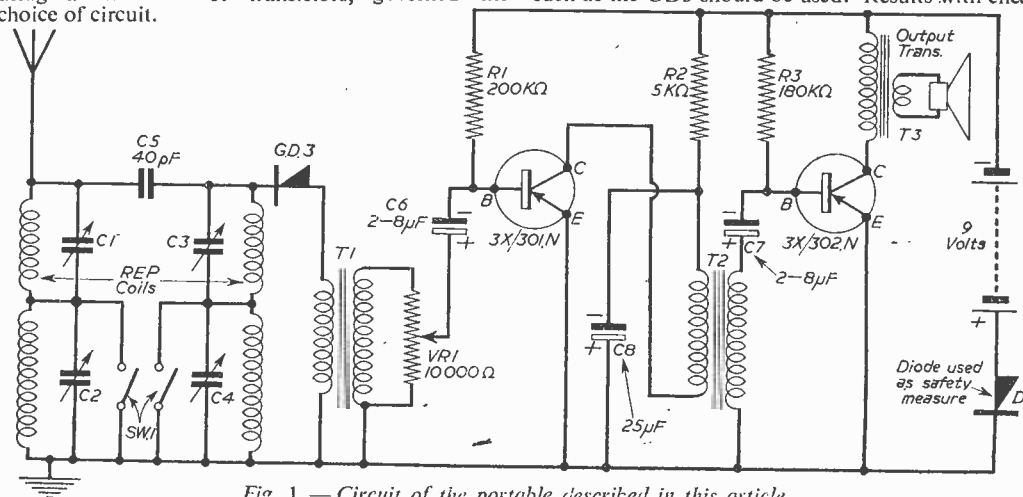

Fig. 1.— Circuit of the portable described in this article.

diodes are often disappointing, giving poor quality reception and a marked diminution in volume.

### The Amplifier

Brimar junction transistors are used; a 3X/301N in the first stage followed by a 3X/302N.

The output from the crystal feeder is matched into the input of the first transistor by a step-down transformer, ratio 5 to 1. A similar transformer is

have an on/off switch for the battery. When operating the set the volume control should be used judiciously, otherwise distortion may occur due to overloading the transistors.

Coupling condensers, C6 and C7, may be any value 2 to 8  $\mu$ F. Electrolytics should be connected with polarity as shown in Fig. 1. Decoupling condenser C8 may be 25 or 50  $\mu$ F, 25 or 50 volt test.

A diode is connected in the battery lead as a safety measure. A cheap diode may be used provided it is tested first by connecting it in series with a voltmeter, across a 9 volt battery. Connected with anode of diode to positive of battery, voltage should be about  $8\frac{1}{2}$  volts. Reversing diode should result in scarcely any reading. With such a diode inserted in the battery lead the minute reverse current which would pass through the diode if the battery were accidentally reversed would cause no damage to the transistors in the set.

The values of resistances R1, R2, R3 were found experimentally having due regard for the maximum ratings of the transistors as given in the manufacturers' literature. The collector current of Trans. 2 is about 4 mA; allowing for the voltage drop in the output transformer and the diode there will be about 26 milliwatts output to the speaker. This may seem very small in comparison with modern valve outputs, but a surprisingly useful volume and tone can be obtained from a good quality loudspeaker. A

good output transformer to match the speaker is also a decided asset. If the constructor can afford the room a larger speaker than 6 in., preferably mounted on a large baffle board, will enhance the quality considerably.

### Constructional Details

Home constructed sets do not always find favour with the opposite sex. Few radio enthusiasts are

used to match into the second transistor. Suitable transformers can be purchased from Whiteley Electric Co., Mansfield, or H. Ashworth, Bradford. Much ex-Service equipment contains suitable transformers; ratios 4 and 6 to 1 step-down can be used as the ratio is not critical.

V1, across the secondary of T1, controls volume; it may be any value 5,000 to 10,000 ohms and should

### LIST OF COMPONENTS.

Two R.E.P. crystal coils (coils 1 and 2).

Four trimmers, each 250 pF (C1, C2, C3, C4).

One condenser 40 pF (C5).

Two condensers, each 2  $\mu$ F (C6 and C7). These may be electrolytics and any value 2 to 8  $\mu$ F.

One condenser 25  $\mu$ F, electrolytic, 25 volt test (C8).

One switch, double pole on/off (Bulgin or similar), SW1.

Two transformers, step-down, ratio 5 to 1 (T1 and T2) (Whiteley Electric Co., Mansfield, or H. Ashworth, Bradford).

One transformer, output, to match speaker (T3).

One volume control, 10,000 ohms with on/off switch (V1).

One resistance, 200 K.,  $\frac{1}{2}$  watt (R1).

One resistance, 180 K.,  $\frac{1}{2}$  watt (R3).

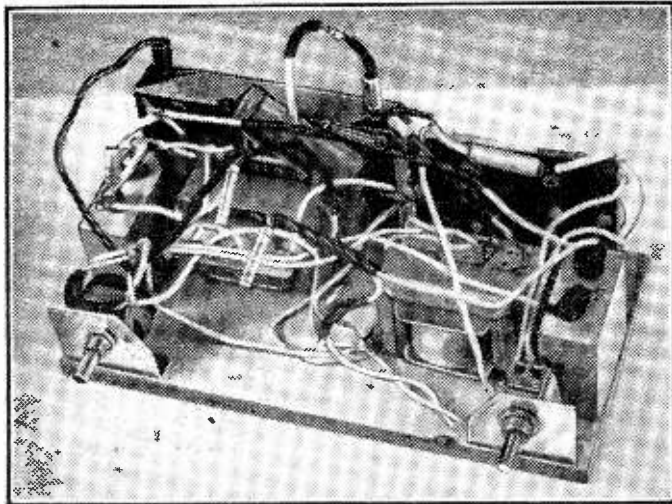

A view of the components and wiring.

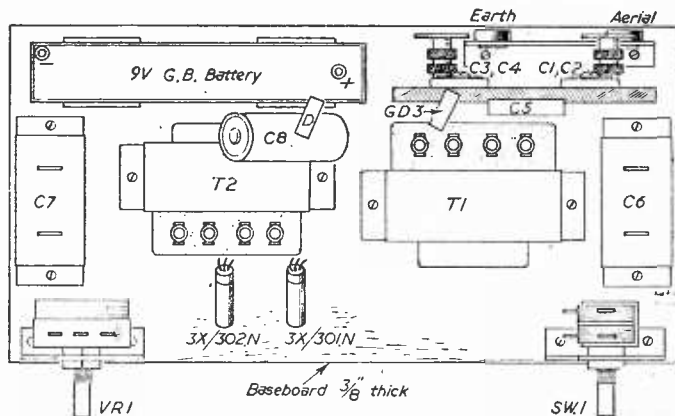

Fig. 2.—Layout of the components.

skilled cabinetmakers. Making a cabinet, staining and polishing to high standards is either beyond most of us or considered too tedious a job to give up many hours of pure radio work. This difficulty is overcome by making the cabinet of plywood and covering with rexine cloth, resulting in a very satisfactory finish.

**The Cabinet**

The dimensions are as follows: Front 10in. x 7½in., depth 5½in. (outside). Front and sides are cut out of ½in. plywood; one front piece 10in. x 7½in., and two side pieces 7in. x 4½in. Top and bottom are two pieces of ½in. plywood, each 10in. x 5½in. A hole for the speaker 4½in. x 3½in., and 1½in. from the top edge of the front and centrally placed is cut out before nailing the pieces together. Two holes are required at the top for the carrying handle and two holes in the front panel to take the control spindles. The position of these is best found by mounting the two controls on the baseboard (see later), rubbing chalk on the ends of the spindles and pressing on to the back of the panel.

**Covering**

A piece of rexine cloth 23in. x 20½in. is required. Rexine cloth can be purchased in many shades and it is not difficult to obtain a suitable pattern to match any desired colour scheme. Alternatively the cabinet may be covered with Formica.

The rexine is placed face downwards on the bench and the cabinet placed on it centrally, face downwards. Pencil marks are made round the front edges and round the speaker hole; the cabinet is then removed and white Bostik applied to the pencilled portion. The cabinet is then placed on top face downwards, the whole turned over and the rexine

smoothed and pressed down with a cloth. Cuts are made in the rexine diagonally to the corners; the two side pieces are stuck down and trimmed to the edges, followed by the same procedure with the top and bottom pieces, using the same adhesive. The wrap-over pieces are then trimmed diagonally at the corners of the back and stuck down. From the back small holes are pierced in the centre of the loudspeaker hole and in the centres of the two spindle holes. Cuts are made from the centres to the edges

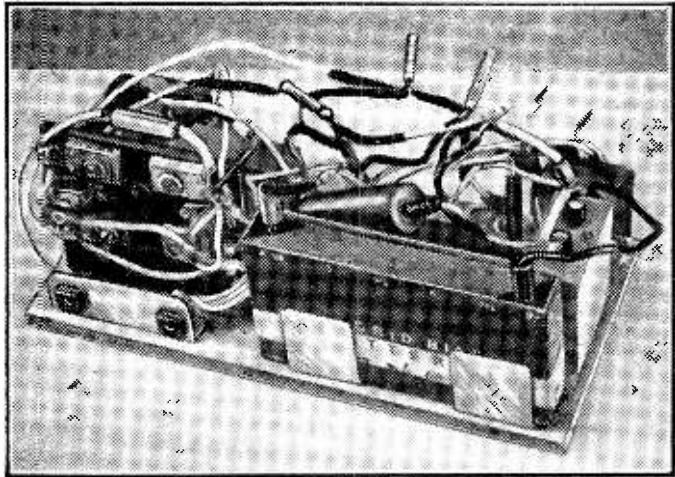

Another view of the interior.

of these holes and the strips of rexine stuck down. A rectangular plastic grill is screwed to the front and decorated with four chromium-plated domes at the corners. Finally, the back is cut out of ½in. plywood, size 9½in. by 6½in., drilled with several vent holes (three rows ½in. diameter) and holes for the trimmers and aerial and earth plugs. This is

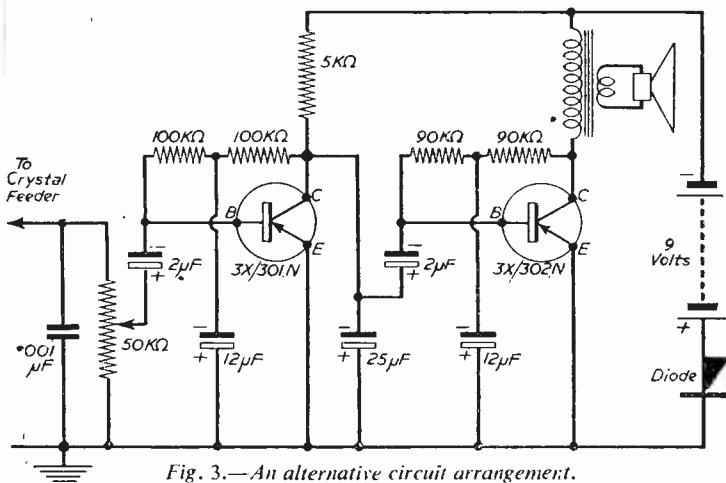

Fig. 3.—An alternative circuit arrangement.

- LIST OF COMPONENTS**
- One resistance, 5 K. ½ watt (R2).
  - One 6in. P.M. loudspeaker (W.B. or similar).
  - One 9-volt G.B. type battery or two 4½ volt flashlight batteries connected in series.
  - One diode GD3, Brimar, and one diode (D), GD5 or cheap one passing test.
  - One transistor, 3X/301N., Brimar.
  - One transistor, 3X/302N., Brimar.
  - Connecting wire, solder, plugs, plywood, rexine.
  - Bostik (white), small nails, aluminium sheet, insulating tape, wood screws (½in. and ¾in.), knobs, handle, plastic grill, chromium domes.
- If it is desired to use other makes of junction transistors a 5 mA meter should be inserted in series with the collector leads and the values of R.1, R.2, R.3 and voltage supply adjusted to conform to manufacturers' ratings.

covered with rexine, the holes cut round with scissors and trimmed with a small round file. The back is screwed to two small triangular corner pieces at the top corners of the back of the cabinet, cut out of  $\frac{3}{4}$  in. plywood and screwed to the baseboard at the bottom corners. The carrying handle holes are pierced and the handle screwed in position. If care is taken before covering to ensure that there are no projecting nails or rough edges the finished cabinet should present a pleasing appearance.

#### Mounting the Components

The components are mounted on a plywood baseboard, size  $9\frac{1}{2}$  in.  $\times$   $4\frac{3}{4}$  in.,  $\frac{3}{8}$  in. thick. The switch, volume control and two plugs (aerial and earth) are mounted on small brackets made out of scrap pieces of aluminium sheet, and screwed to the baseboard with wood screws. Two strips of aluminium sheet bent twice and screwed down on the board formed clips for the battery. The coils and trimmers are mounted on a piece of paxolin  $3\frac{1}{2}$  in.  $\times$   $3\frac{1}{2}$  in., bolted to a bracket and screwed to the baseboard. The position of all these components is shown in Fig. 2.

#### Wiring

Care should be taken when soldering the transistors; they can be damaged by heat. The leads should not be cut short, and should be held with pliers, tinned and soldered to the connecting leads, using a minimum amount of heat, and allowed to cool before removing the pliers. Then each lead should be covered with insulating tape right up to the body of the transistor. The diode leads should also be held with pliers when soldering. Leads and plugs to the battery should be of a distinctive colour, preferably red for positive and black for negative connections. Brackets and condenser cans are earthed. It is advisable to cover all exposed joints and wires with insulating tape to avoid any possibility of any wires touching and causing a reversal of the battery connections.

Apart from these precautions the wiring is straightforward. To avoid a muffled tone due to small cabinet size the speaker is mounted on four small pieces of plywood  $\frac{1}{4}$  in. thick.

## Sun Spot Activity

**A** THREE or four year period, during which appearances of sunspots on the sun's surface will be more frequent than at any time since the year 1949, recently began.

The reliability of long-distance wireless communications is affected by sunspots; but there is considerable public misunderstanding as to the nature of the effects. The following extracts are given from an explanatory note which has been issued by Cable and Wireless, Ltd. :-

It is correct to say that some sunspots interrupt long-distance wireless circuits; but incorrect to infer that the more numerous the sunspots the poorer the wireless conditions. On the contrary, it is generally true that the greater number of sunspots the better the performance of long-distance wireless circuits.

It happens in this way. High-frequency wireless waves—the kind used for long distance communications—travel upwards to the ionosphere, a region of gases in the upper atmosphere which are electrified, or "ionised," by ultra-violet rays from the sun. The ionosphere normally reflects the waves at an

#### Testing and Adjusting

Before switching on the wiring should be rechecked, paying particular regard to the base, emitter and collector connections of each transistor, and also the battery connections. A reversal of polarity will quickly destroy the transistors. On this account it is wise to plug in to a low voltage—3 volts—for preliminary testing. The medium-wave trimmers should be adjusted first on a low setting of the volume control, followed by the long-wave trimmers. If everything seems to be in order the voltage should be increased to maximum and the process repeated. Howling indicates a fault in the wiring. If this occurs the set should be switched off and the fault found before proceeding any farther with the testing.

The final result should be satisfactory to the constructor, who should have a receiver providing ample volume for bedside listening and presenting a pleasing appearance.

#### Alternative Circuit

Fig. 3 shows an alternative resistance capacity coupled circuit: This will be satisfactory only under the following working conditions:

(i) Using a 6in. speaker in a good reception area and indoor aerial.

(ii) Using an 8in. speaker in a moderate reception area and same aerial.

(iii) Using either type of speaker with a good outdoor aerial or in a few districts with a good indoor aerial.

To obtain maximum volume from a resistance capacity coupled circuit it is necessary to eliminate regenerative feedback caused by the biasing resistances connected between base and collector. To do this the resistances are divided equally and the centre bypassed to earth through a condenser value 8 to 20  $\mu$ F.

This circuit is given solely for the benefit of those readers who are experimentally minded. Anyone in doubt should keep to the transformer coupled circuit (Fig. 1), which will be satisfactory under all but the most adverse conditions.

angle back to earth where they are reflected back to the ionosphere, and so they travel in a series of hops.

The degree of ionisation and the quality of reflection of the ionosphere is affected by several causes. Among them are sunspots and magnetic storms.

Sunspots are visible indications of changes in the sun. The frequency of these changes rises and falls with a rough time interval of 11 years between successive peaks and between successive troughs. The peak periods of change are known as periods of sunspot maximum, and the troughs as sunspot minimum periods. As energy from the sun is responsible for the formation of the ionosphere, the ability of this region to reflect wireless waves back to the earth also changes steadily over the solar cycle, being greater at sunspot maximum than at sunspot minimum.

In addition to this steady, predictable change in solar activity, there occur relatively short-lived changes, usually of a violent character, which also affect the ionosphere—mainly by reducing its reflecting properties. Such short-lived changes, which may be due to a magnetic storm or flaring sunspot, are called ionospheric disturbances.





**COMPLETELY BUILT SIGNAL GENERATOR**

Coverage 120 Kc's-320 Kc s., 300 Kc s-900 Kc s., 900 Kc s-2.75 Mc s., 2.75 Mc s-8.5 Mc s., 8 Mc s-28 Mc s., 16 Mc s-56 Mc s., 24 Mc s-84 Mc s. Metal case 10in. x 6 1/2 in. x 4 1/2 in. Size of scale, 6 1/2 in. x 3 1/2 in. 2 valves and rectifier. A.C. mains 230-250 v. Internal modulation of 400 c.p.s. to a depth of 30 per cent., modulated or unmodulated R.P. output continuously variable 100 milli-volts. C.W. and mod. switch, variable A.F. output and moving coil output meter. Black crackle finished case and white panel. Accuracy plus or minus 2%. £4 19 6 or 34/- deposit and 3 monthly payments 25/- P. & P. 4 6 extra.

Three-speed automatic changer. B.S.R. Monarch, current model. Will take 7in., 10in. or 12in. records mixed. Turnover crystal head, cream finish. VERY LIMITED QUANTITY. A.C. mains 200 250. £7 15 0. P. & P. 3/-.

**COMMERCIAL TELEVISION CONVERTER**

SUITABLE ANY T.V. NO ALTERATIONS TO SET Complete with built-in power supply. 230-250 v. A.C. mains. Crackle finish case 5 1/2 in. long, 3 1/2 in. wide, 4 1/2 in. high. Incorporating gain control and band switch. Illustrated with cover removed. £3. 19. 6 Plus P. & P. 2/6 Less Power supply £2/19 6. P. & P. 2/6

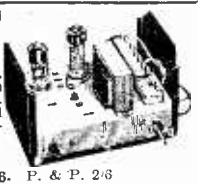

Heater Transformer. Pri. 230-250 v. 6v. 11 amp. 6/- Extension Speaker cabinet in polished walnut, complete with 8in. P.M. P. & P. 3/- 24/6.

8in. P.M. Speakers, removed from chassis, fully guaranteed. All by famous manufacturers. P. & P. 1/6. 12/6.

Volume Controls. Long spindle less switch, 50 K., 500 K., 1 meg., 2/6 each. P. & P. 3d. each.

**GARRARD RC/110 3-SPEED AUTOMATIC CHANGER**

10 records, turnover crystal head, brand new, A.C. mains 100 250 v. ... £8. 19. 6 LIST PRICE £14/10 0. P. & P. 5/-

Volume Controls. Long spindle and switch, 1, 1, 1, and 2 meg., 4/- each, 10 K. and 50 K., 3/6 each, 1 and 1 meg., long spindle, double pole switch, miniature, 5/-

Standard Wave-change Switches, 4-pole 2-way, 1/9 : 5-pole 3-way, 1/9. Miniature 3-pole 4-way, 4-pole 3-way, 2/6. 2-pole 11-way twin wafer, 5/-, 1-pole 12-way single wafer, 4/-

**16" TUBE BY FAMOUS MANUFACTURER**

Brand new E.H.T. 14 Kv. Heater. 6.3 volts 0.6 amp., guaranteed 3 months. £9. 19. 6 E. H. T. and scanning components Post, packing and insurance 22/6. H.P. terms available.

1,200 ft. High Impedance recording tape on aluminium spool 12/6 post paid.

Polishing attachment for electric drills. Quarter-inch spindle, chromium-plated, 5in. brush, 3 polishing cloths and one sheep-skin mop, mounted on a 3in. rubber cup. P. & P. 1/6. 12/6. Spare sheep-skin mops, 2/6 each.

**R. & T.V. COMPONENTS (ACTON) LTD.**  
23, HIGH STREET, ACTON, LONDON, W.3

**3-speed TRANSCRIPTION MOTOR BY FAMOUS MANUFACTURER**

Complete Kit of parts comprising accurately balanced precision made heavy turntable with rubber mat, large constant speed condenser, starting motor, base plate. Can be assembled in half-an-hour. A.C. Mains 200/250 v Fully guaranteed. Parts sold separately.



£6. 19. 6 Post paid.

**4 VALVE ALL-DRY SUPERHET PORTABLE KIT**

Medium and long waves. In grey leatherette. Size 6in. x 7in. x 6in. Valve line-up: 1T4, IR5, 1S5, 3V4. Complete kit of parts (less batteries).



£6. 6. 0 Plus Post & Packing 2/6

**T.R.F. KIT in PLASTIC CABINET**

3 valve plus metal rectifier. A.C. mains 200-250 v. Medium and Long waves. In pastel blue or brown. Valve line-up: 2 VR655 and VT52. Size 15 1/2 in. long by 9 1/2 in. high by 7 in. deep.

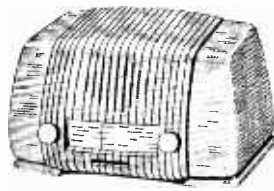

£3. 19. 6 P. & P. 4/6.

Used Metal Rectifier, 230 v. 50 mA., 3/6 : gang with trimmers, 6/6 : M. & L. T.R.F. coils, 5/- : 3 Govt. valves, 3 v/h and circuit, 4/6 : heater trans., 6/- : volume control with switch, 3/6 : wave-change switch, 2/- : 32 x 32 mfd., 4/- : bias condenser, 1/6 : resistor kit, 2/- : condenser kit, 4/-.

P.M. SPEAKERS, 6 1/2 in., closed field, 18/6. 8in., closed field, 20/6. 10in., closed field, 25/-, 12in., 25/-, 3 1/2 in., 16/6. P. & P. on each 2/-

Valveholders, Paxolin octal, 4d. Moulded octal, 7d. EF50, 7d. Moulded B7C, 7d. Octal amphenol, 7d. Octal pax., 7d. Mazda Amph., 7d. Mazda pax., 4d. B8A, B9A amphenol, 7d. BTG with screening can, 1/6. Duodecal paxolin, 9d.

Twin-gang .0005 Tuning Condensers, 5/- With trimmers, 6/6.

32 mfd., 350 wkg. ...	2/-	16 + 16 mfd., 350 wkg. ...	3/3
16 x 24 350 wkg. ...	4/-	60 + 100 mfd., 280 v. wkg. ...	7-
4 mfd., 200 wkg. ...	1/3	50 mfd., 180 wkg. ...	1/9
40 mfd., 450 wkg. ...	3/6	65 mfd., 220 wkg. ...	1/6
16 x 8 mfd., 500 wkg. ...	4/6	8 mfd., 150 wkg. ...	1/6
16 x 16 mfd., 500 wkg. ...	5/9	50 mfd., 12 wkg. ...	11d.
16 x 16 mfd., 450 wkg. ...	3/9	50 mfd., 50 wkg. ...	1/9
32 x 32 mfd., 350 wkg. ...	4/-	Miniature wire ends	
25 mfd., 25 wkg. ...	11d.	moulded 100 pf., 500 pf.,	
250 mfd., 12 v. wkg. ...	1/6	and 601 ea.	7d.
16 mfd., 500 wkg., wire	3/3	280-0-280 80 mA., 4 v. 4 a.,	
ends ...	1/6	4 v. 2 a. ...	14/6
8 mfd., 500 v. wkg., wire	2/6	250 v. 350 mA., 6.3 v. 4 a.	
ends... ..	2/6	twice 2 v. 2 a. ...	19/6
8 mfd., 350 v. wkg., tag	1/6	Auto-trans., input 200/250	
ends... ..	1/6	HT 500 v. 250 mA., 6 v.	
100 mfd., 350 wkg. ...	4/-	4 a. twice 2 v. 2 a. ...	19/6

Potato & Vegetable Peeler, by famous manufacturer, capacity 4 1/2 lbs., complete with water pump. All aluminium construction, white stove-enamelled finish. Originally intended for adaptation on an electrical food-mixer, can easily be converted for hand operation. 39/6. P. & P. 3/-.

Where post and packing charge is not stated, please add 1/6 up to 10/-, 2/- up to £1 and 2/6 up to £2. All enquiries S.A.E. Lists 5d. each.

# NEWNES Radio and Television Servicing



**320 POPULAR 1955-56 Models  
IN ONE VOLUME**

**Free for 7 days**

HERE is the latest volume in Newnes RADIO AND TELEVISION SERVICING Library. It adds 320 popular 1955-56 models to your servicing range. Servicemen who are profiting from these yearly volumes know their value in £ s. d. and snap them up as soon as they are published! If you have not yet started building a Newnes library of Radio and Television data, claim Free Examination and judge for yourself!

**348 Pages of T.V. Servicing Data  
198 Pages of Radio Servicing Data**

CONTAINS RECENT DEVELOPMENTS including:  
Servicing of V.H.F./F.M. receivers.  
Conversion for I.T.A. programmes.  
Band III aerials. Colour Television.  
3-D loudspeaker systems. Latest circuit progress.

**596  
PAGES  
320  
MODELS**

**TELEVISION**  
MODELS BY ...  
Alba, Ambassador, Baird, Banner, Bush, Cossor, Decca, Defiant, Ekco, E.M.I., English Electric, Ferguson, Ferranti, G.E.C., H.M.V., Invicta, K-B, McCarthy, McMichael, Marconiphone, Masteradio, Murphy, Peto Scott, Philco, Philips, Pilot, Portadyne, Pye, Rainbow, Regentone, R.G.D., Sobell, Stella, Ultra, Valradio, Vidor.

**RADIO**  
MODELS BY ...  
Ace, Banner, Bush, Champion, Cossor, Decca, Defiant, Eddystone, Ekco, Ever Ready, Ferguson, Ferranti, G.E.C., Grundig, Invicta, K-B, McCarthy, McMichael, Marconiphone, Masteradio, Murphy, Philco, Philips, Pilot, Pye, Regentone, R.G.D., Roberts' Radio, Sobell, Strad, Ultra, Vidor.

## CLAIM FREE EXAMINATION NOW

To: George Newnes Ltd., 66-69 Gt. Queen St., London, W.C.2.  
Send me the 1955-1956 VOLUME of Newnes RADIO AND TELEVISION SERVICING. I will either return it in 8 days or send 10/- deposit 8 days after delivery, then 10/- monthly, paying 50/- in all. Cash Price in 8 days, 45/-.

Name.....  
Address.....  
Place X where it applies  
Occupation.....  
Signature.....  
(Parent's Signature if under 21) **R.IG**

HouseOWNER
Householder
Living with Parents
Lodging Address

## T.V. TUBES. GUARANTEED £5

17" 16" 15" 14" 12"  
HOLIDAY SALE

17" RECTANGULAR ..... £7.10.0  
14" RECTANGULAR ..... £5.10.0  
12" ROUND type ..... £5.0.0  
Mullard 6 months' guarantee. Mazda 3 months'. Other types and makes stocked. Please enquire.

## 12" T.V. CHASSIS 97/6

Complete television chassis by famous mfr.; R.F. E.H.T. unit included. Easily fitted to table or console model. Owing to this chassis being in 3 separate units (power, s/vision, t/base) interconnected.

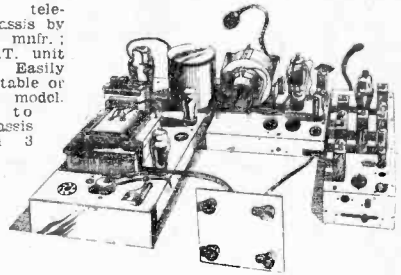

EASILY CONVERTED TO I.T.V. CHANNEL. Channels 1-5. Drawing 2/6, or free with order. Our £5 tube fits this chassis. Lists by request. Less valves and tube. Carr. 5/- London. 10/- Provinces.

Please PRINT name & address. Remember SATURDAY open all day.

MONEY BACK GUARANTEE **DUKE** £CO. Tel: GRA 6677 CWO of COD  
621 ROMFORD RD. LONDON, E.12.

## TECHNICAL TRADING CO. SPECIAL GUARANTEED SNIPS

**BARGAIN!** 12 v. 4 amp. RECTIFIERS 9/6! £5 DOZ. Iron Selenium, full wave charging type.  
**H28 (CR100) COMMUNICATION RECEIVERS.**—10-4,000 metres, Xtal. Complete 11 valves, good condition, untested. £12.10, carr. 12/6. SCR522 Transceivers, complete. £4.10.  
**COSSOR 339 D.B. OSCILLOSCOPES.**—Tested, good condition. £17.10, carr. 12/6. Monitors type 33, £5.  
**ALUMINIUM CHASSIS.**—Undrilled, 16/18 gage, 6 x 4 1/2 x 2 1/2; 8 x 5 x 2 1/2; 3/6; 8 x 6 x 2 1/2; 3/9; 10 x 8 x 2 1/2; 4/9; 12 x 8 x 2 1/2; 5/9, post 1/-.  
**TEST SETS TYPE 74A.**—Oscilloscopes, 200-250 v. AC. Ideal conversion to standard scopes. £3.15, carr. 10/-.  
**TAPE RECORDER CASES.**—Blue rexine, hinged lid, 2 locks, carrying handle, size 16in. w. x 12in. d. x 9in. h. 25/-, carr. 3/6. Ditto, beige, de luxe, famous make. 45/-, carr. 4/-.  
**MEG. POTS D.P. SWITCH.**—3in. spindle, small type only. 3/6, post 4d. .002 18 kv. Visconal, 4/9, post 9d.  
**TUBAT MICS.**—British, boxed with jack plug, 2/6, post 6d. Single L.R. earphones with headband, 2/6, post 8d.  
**F.M. TUNERS, ECL85, EF90, ECH81, E280, AC Power Pack,** attractive finish, listed 19 gns., 27.5, less valves £5, less valves, and mains trans. £3.15, Carr. 3/-, all new, boxed, untested.  
**INDICATORS TYPE 95.**—VCR37, 16 valves, 49/-, carr. 7/6.  
**CONDENSERS.**—Latest ceramic, 10, 20, 50, 100, 1,000, 3,000 pf. 5/- doz, post 6d. 2 bank 30 pf. trimmers 8d., 4 bank 1/-.  
**LATEST ELECTROLYTICS.**—100 mid. 6 vw. 1/-; 8 mid., 250 vw. 1/3; 16+16, 350 vw. 3/-; 60+120, 350 vw. 7/6.  
**RESISTANCES.**—1 w. mixed, 474-1m0 2/- doz. 10- 100.  
**AMPHENOL VALVE HOLDERS.**—Octal, 8BA, 87G, 89A, 89G, 6/- doz. 89A w screen, 1/3, 12/- doz.  
**W.W. PRESET POTS.**—500 0, 1K, 2.5K, 5K, 10K, 20K, 25K, 2/- ea. 8in. P.M. SPEAKERS.—Top makes, 12/6, post 1/6. Ditto EK EQPT. tested, 8/6, post 1/6. Elliptical 7 x 4, 17/6, post 1/3. 12 volt 10/20 w. AMPLIFIERS.—Inbuilt motor gen., compact, ideal outdoor work, push/pull 8/6, and 2 double triodes, cost approx. £30, good cond., untested, £5.10, carr. 10/-.

**RADIO VALVES GUARANTEED PERFECT**  
6AK5 6/6 6F33 8/6 12AX7 8/- 6F92 4/6 8P61 3/6  
6AG5 5/6 6J6 6/6 KT68 9/6 6U4G 6/6 807 6/6  
6AL5 5/- 6J7C 4/6 813 50/- 6L91 5/6 8P210 3/6  
6C4 6/6 6J5G 4/- 6B34 2/- 6Z25 8/- U22 8/6  
6FG6 6/6 6K7M 6/- 6CC31 8/- PY31 4/6 VR150 30/6-  
★ 1,000 Other Bargains to Callers at ★  
**PORTSMOUTH'S RADIO, TV AND TOOL SHOP**  
350/352, FRATTON ROAD, PORTSMOUTH

# THE NATIONAL

EARLS COURT  
August 22nd to  
September 1st

List of Principal Exhibitors  
in Alphabetical Order,  
with Stand Numbers

# RADIO SHOW

Name	Address	Stand No.	Name	Address	Stand No.
Aerialite, Ltd. ...	Castle Wks., Stalybridge, Cheshire	51	English Elec. Co., Ltd.	Queens Hse., Kingsway, W.C.2	40
Airmec, Ltd. ...	High Wycombe, Bucks.	212	Ever Ready Co. (G.B.), Ltd.	Hercules Place, Holloway, N.7	54
Ambassador Radio & T/V, Ltd.	37/39, Thurloe Street, S.W.7	43	Ferguson Radio Corp., Ltd.	105-109, Judd St., W.C.1	12
Antiference, Ltd.	Bicester Rd., Aylesbury, Bucks.	69	Ferranti, Ltd.	Hollinwood, Lancs.	31 & 68
Automatic Coil Winder & Elec. Equip. Co., Ltd.	"Avocet House," 92/96, Vauxhall Bridge Rd., S.W.1	3	Garrard Eng. & Mfg. Co., Ltd.	Newcastle St., Swindon, Wilts.	50
Balcombe, Ltd., A. J.	52-58, Tabernacle St., E.C.2	61	General Elec. Co., Ltd. ...	Magnet Hse., Kingsway, W.C.2	53
Belling & Lee, Ltd.	Gt. Cambridge Rd., Enfield, Middx.	49	Goodmans Industries, Ltd.	Axiom Wks., Lancelot Rd., Wembley, Middx.	105
Bowmaker, Ltd....	29/30, St. James's St., S.W.1	208	Gramophone Co., Ltd.	Hayes, Middx.	28
Bulgin & Co., Ltd., A. F.	Bye Pass Rd., Barking, Essex	26	Harf & Co., Ltd., Alfred	243-249, Upper St., High-bury Corner, Islington, N.1	209
Bush Radio, Ltd.	Power Rd., Chiswick, W.4	17 & 29	Hunt (Capacitors), Ltd., A. H.	Bendon Valley, Garratt Lane, Wandsworth, S.W.18	25
Channel Electronic Industries, Ltd.	Dunstan Rd. Estate, Burnham-on-Sea, Somerset	108	Independent Television Authority	14, Princes Gate, S.W.7	309, 310 & 311
Cole, Ltd., E. K....	Ekco Wks., Southend-on-Sea, Essex	24 & 30	Invicta Radio, Ltd.	100, Gt. Portland St., W.1	65
Collaro, Ltd. ...	Ripple Wks., By-Pass Rd., Barking, Essex	21	J. B. Mfg. Co. (Cabinets), Ltd.	Howard Way, Harlow, Essex	115
Co-operative Wholesale Society, Ltd.	1, Balloon St., Manchester, 4	35 & 37	J. Beam Aerials, Ltd.	Westonia Weston Favell, Northampton	1
Cosmocord, Ltd.	700, Gt. Cambridge Rd., Enfield, Middx.	202	Kolster-Brandes, Ltd.	Footscray, Sidcup, Kent	20
Cossor, Ltd., A. C.	Cossor Hse., Highbury Grove, N.5	57	Labgear (Cambridge) Ltd.	Willow Place, Cambridge	203
Cossor Instruments, Ltd.	Cossor Hse., Highbury Grove, N.5	206	McMichael Radio, Ltd.	S'ough, Bucks.	59
Decca Record Co., Ltd.	1-3, Brixton Rd., S.W.9	58	Marconiphone Co., Ltd.	Hayes, Middx.	23
Domain Products, Ltd.	Domain Wks., Barnby St., N.W.1	107	Masteradio, Ltd.	10-20, Fitzroy Place, N.W.1	15
Dubilier Condenser Co. (1925), Ltd.	Ducon Wks., Victoria Rd., North Acton, W.3	62	Mullard, Ltd. ...	Century Hse., Shaftesbury Ave., W.C.2	32
Dynatron Radio, Ltd.	"The Firs," Castle Hill, Maidenhead, Berks.	4	Multicore Solders, Ltd.	Maylands Ave., Hemel Hempstead, Herts.	10
E. A. P. (Tape Recorders), Ltd.	9, Field Place, St. John St., E.C.1	215	Murphy Radio, Ltd.	Welwyn Garden City, Herts.	42
E.M.I., Ltd. ...	Hayes, Middx.	16	NEWNES, LTD., GEORGE	Tower Hse., Southampton Street, Strand, W.C.2	111
E.M.I. Institutes, Ltd.	10, Pembroke Sq., W.2	307	Nixa Record Co., Ltd.	66, Haymarket, S.W.1	5
Edison Swan Elec. Co., Ltd.	155, Charing Cross Rd., W.C.2	19			
Electric Audio Producers, Ltd.	The Square, Isleworth, Middx.	67			

Name	Address	Stand No.	Name	Address	Stand No.
Pam (Radio & T/V) Ltd.	295, Regent St., W.1	55	Spencer-West, Ltd.	Quay Works, North Quay, Great Yarmouth, Norfolk	211
Pamphonic Reproducers, Ltd.	17, Stratton St., W.1.	34	Standard Tel. & Cables (Brimar) Ltd.	Receiver Valve Division, Footscray, S i d c u p, Kent	39
Peto Scott Elec. Instruments, Ltd.	Addlestone Rd., Weybridge, Surrey	14	Standard Tel. & Cables, Ltd. (SenTerCel)	Connaught Hse., Aldwych, W.C.2	117
Philco (Overseas), Ltd.	Romford Rd., Chigwell, Essex	22	Stella Radio & Tel. Co., Ltd.	Oxford Hse., 9-15, Oxford St., W.1	56
Philips Elec., Ltd.	Century Hse., Shaftesbury Ave., W.C.2	44 & 45	Tape Recorders (Electronics) Ltd.	784-788, High Rd., Tottenham, N.17	38
Pilot Radio, Ltd....	Park Royal Rd., N.W.10	27	Taylor Electrical Instruments, Ltd.	Montrose Ave., Slough, Bucks	106
Plessey Co., Ltd....	Vicarage Lane, Ilford, Essex	9	Telegraph Condenser Co., Ltd.	Wales Farm Rd., North Acton, W.3	64
Portogrand Radio Elec. Ind., Ltd.	Preil Wks., St. Rule St., S.W.8	66	Telerection, Ltd.	Antenna Wks., St. Pauls, Cheltenham, Glos.	18
Pye, Ltd.	Cambridge	13	Telequipment, Ltd.	313, Chase Rd., Southgate, N.14	63
<b>" PRACTICAL WIRELESS "</b> <b>AND " PRACTICAL TELEVISION "</b> <b>STAND No. 111</b>					
RCA Photophone, Ltd.	Lincoln Way, Windmill Rd., Sunbury-on-Thames, Middx.	103	Ultra Elec., Ltd....	Western Ave., Acton, W.3	41
Radio & Allied Ind., Ltd.	Langley Park, Slough, Bucks.	33	Valradio, Ltd. ...	New Chapel Rd., Feltham, Middx.	213
Radio Gramophone Dev. Co., Ltd.	Eastern Avenue West, Mawneys, Romford, Essex	52	Vidor, Ltd. ...	West St., Erith, Kent	11
Regentone Radio & T/V, Ltd.	Eastern Ave. West, Romford, Essex	60	Waveforms, Ltd....	Radar Wks., Truro Rd., N.22	205
Roberts' Radio Co., Ltd.	Creek Rd., East Molesey, Surrey	48	Westinghouse Brake & Signal Co., Ltd. ...	82, York Way, King's Cross, N.1	102
Rola Celestion, Ltd.	Ferry Wks., Thames Ditton, Surrey	6	Whiteley Elec. Radio Co., Ltd.	Radio Wks., Victoria St., Mansfield, Notts	47
Simon Sound Service, Ltd.	48, George St., Portman Square, W.1	46	Wolsey Television, Ltd.	43-45, Knight's Hill, West Norwood, S.E.27	2

## News from the Clubs

### CLIFTON AMATEUR RADIO SOCIETY

Hon. Sec.: C. H. Bullivant (G3DIC), 25, St. Fillans Road, Catford, S.E.6.

TWO interesting talks were heard during May, the first being on May 4th, when Mr. M. Paveley (VQ4CW, ex-G3GWD) gave details of amateur radio in Kenya and the second on May 18th, when Mr. G. Alderman (G3BNE), of the Decca Radar Co., spoke on Decca navigational aids.

The first D.F. contest of the 1956 series took place on May 13th and was won by E. Strong. Second and third respectively were C. Hatfull (G3HZI) and R. Rogers (G3KUR). Three other teams entered the contest, but were unsuccessful in locating the transmitter.

July diary: 13th, "Tape Recording," by L. Allen (G3MZ); 15th: Third D.F. contest; 29th: Transmitting Field Day.

Meetings are held every Friday at 7.30 p.m. at the clubrooms, 225, New Cross Road, London, S.E.14, when visitors and new members will receive a warm welcome. Details of membership can be obtained from the hon. secretary.

### TORBAY AMATEUR RADIO SOCIETY

Hon. Sec.: L. H. Webber (G3GDW), 43, Lime Tree Walk, Newton Abbot.

THE May meeting was held under the chairmanship of G2GK. Final details were settled for the co-operation of members in the field day of the R.S.G.B. Both stations will be held in the same site in order to conserve personnel and expense.

Dates for the coming winter season for the society were discussed and are not yet settled.

Details were also discussed of the approaching No. 9 District O.R.M., which will be held on Sunday, October 7th, 1956, at the Oswalds Hotel, Babbacombe, Torquay.

A junk sale was also held, which yielded a useful sum in support of expenses for the forthcoming N.F.D. of the R.S.G.B., in which most members are co-operating.

### EAST KENT RADIO SOCIETY

Hon. Sec.: D. Williams, Llandogo Bridge, nr. Canterbury.

THE above society still meets weekly on Tuesdays, 7 p.m., at basement of Technical College, Longport Street, Canterbury.

Work is still going on building benches, cupboards, etc. One D.F. set has been tried and found satisfactory. It is hoped to have at least two more in the near future.

Raffles and lectures are also held. Theory given by Mr. D. Williams, hon. sec. New members and visitors in district always welcome.

### THE HULL AND DISTRICT RADIO SOCIETY

Hon. Sec.: M. P. Sqaunce (G3HTB), 118, Wolfraton Lane, Witherby, Hull, E. Yorks.

THE following are forthcoming events:

July 10th: Lecture by Mr. Barry, of Marconi, on test instruments.

July 31st: Two films on ultrasonics by Mullard (the projector has been very kindly lent free of charge by Jordan & Co. (Hull), Ltd.).

Both meetings will be held in the clubrooms at The Royal Oak (Tony's), Hull. Meetings commence at 7.30 p.m.

# BAND 3 T/V CONVERTER—183 Mc/s - 196 Mc/s

Suitable for London, Birmingham and Northern Transmission

**£2-5-0 post free.**

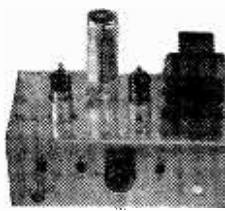

A highly successful unit (W/World circuit), incorporating variable oscillator tuning, Midget BVA valves, etc. Chassis size 7 x 4 x 2 1/2 in. Thousands already in use. Suitable for most types of T/V sets. TRF or Superhet. Kit of parts 45/-. Blueprint 1/6, Power pack kit 30/-. Switch kit (Band 1—Band 3 Ae switching),

6/6—all Post Free. Wiring and aligning of above 20/- extra. Full range of Band 3 aerials in stock. Adaptors from 7/6 per set. Indoor dipoles 5/6. Outdoor with cables, 13/9. Band 1—Band 3 cross-over filter unit, 7/6. Variable attenuators 6 ab—36 ab, 7/6. BBC Break-through Filter, suitable for BBC pattern rejector, 8/6.

## Volume Controls

Log. ratios, 10,000 ohms  
—2 Meg. ohms. Long  
spindles. 1 year  
guarantee. Midget  
Eaton type.  
No. Sw. S.P. Sw. H.P. Sw.  
3/- 4/- 4/3  
Linear Ratio, 10,000  
ohms—2 Meg. ohms.  
Less switch, 4/- each.  
Coax plugs, 1/2. Coax  
sockets, 1/-. Couplers  
1/3. Outlet boxes, 4/8.

## 80 ohm COAX

STANDARD 1/4 in. diam.  
Polythene insulated.  
GRADE "A" ONLY

### 8d. yd.

SPECIAL — Semi-air  
spaced polythene. 80  
ohm Coax 1/4 in. diam.  
Stranded core. Losses  
cut 50%.

### 9d. yd.

TWIN FEEDER, 80 ohms, 6d. yd.; 200 ohms, 8d. yd.  
TWIN SCREEN FEEDER, 80 ohms, 1.3 yd.  
50 OHM COAX CABLE 8d. per yd. 1/4 in. dia.  
TRIMMERS, Ceramic, 1 pf.—70 pf., 8d. 100 pf.,  
150 pf., 1/3. 250 pf., 1/6. 600 pf., 1/9. PHILIPS  
Peetive Type—2 to 10 pf. or 3 to 30 pf., 1.3 each.  
RESISTORS—Pref. values 10 ohms 10 meghoms.

## CARBON

20% Typs. 1 w., 3d.  
1 w., 5d.; 1 w., 6d.;  
2 w., 9d.  
10% Typs. 1 w., 6d.;  
1 w., 7d.; 1 w., 8d.;  
1 w., 9d.

## WIRE-WOUND POTS.

Free-Set Min. T.V. Type.  
Knurled Slotted Knob.  
All values 25 ohms to 30  
K., 3/- ea. 50 K., 4/-.  
1100 Carbon Track  
50 K. to 2 Mez., 3/-.

## CONDENSERS.—Mica or S. Mica.

All pref. values.  
3 pf. to 680 pf., 6d. ea. Ceramic types, 2.2 pf.—5,000  
pf. as available, 9d. ea. Tubular, 450 v., Hunts  
and T.C.C. 0.005, .001, .005, .01 and 1.330 v. 8d.,  
4d., 4d., 1.500 v. Hunts Molded, 1/5. 25 Hunts, 1/3.  
5 Hunts, 1/9. 1.1500 v. T.C.C. (simplex), 3 d.  
201, 6 kv., T.C.C., 5/8. .001 12.5 kv. T.C.C., 9 d.

## SILVER MICA CONDENSERS.—

10V, 5 pf. to 500 pf., 1/- 600 pf. to 3,000 pf., 1.3.  
1V, 1.5 pf. to 500 pf., 1/9. 3.5 pf. to 5,000 pf., 2/-.

## STANDARD 3 WAVELENGTH COIL PACK.

Size 2 1/2 in. x 2 1/2 in. x 1 1/2 in. depth. 4 pos. Switching; Long,  
Med., Short, Gram. Dust-core coils preloaded for  
455 Kcs I.F. Complete with trimmer, ready to use.  
A very sensitive and efficient coil pack.  
Manufacturer's Surplus. Bargain Offer, 30/-.

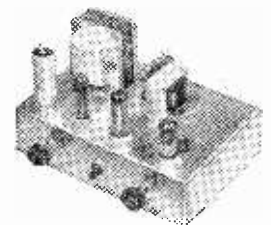

## 3 VALVE AMPLIFIER

With variable Tone and Volume controls. 3 Midget  
B.V.A. valves. 4 watts output. Neg. feedback.  
Chassis isolated from mains. A.C. 200/250 v. A  
quality amplifier at an economical price. PRICE  
£3.19.8. Carr. 2/8. Wired and tested, 15/- extra.  
Blueprint, circuit and instr., 1/6 (free with kit).

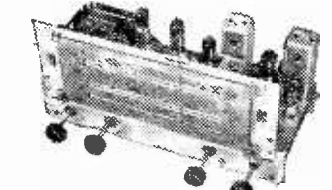

## ALL WAVE BANDGRAM CHASSIS

3 WAVEBANDS, 5 VALVES  
S.A.V. 16 m.—5d. 100 m.—1.3 yd. LATEST MIDGET  
M.W. 200 m.—250 m. BVA  
L.W. 800 m.—2,000 m. SERIES

Brand new and guar. A.C. 200/250 v. 4 pos. W/C  
sw. short-medium-Long-Gram. P.U. socket. High  
Q dust core coils. Latest circuit technique, delayed  
AVC and neg. feedback. O.P. 4 watts. Chassis  
size, 1 1/2 x 5 1/2 x 2 1/2 in. Dial 10 in. x 4 1/2 in. Hor. or vert.  
station names. Walnut or ivory knobs to choice.  
Aligned and calibrated ready for use. Sensitivity  
and Quality at Low Cost.

Chassis isolated from mains. BARGAIN £9.15.0  
Carr. and ins. 4/8.

## 7 Valve De Luxe, push-pull version,

7 watt output, £12.10.0. Carr. & ins. 5/-  
BARGAIN VALUE IN AUTO CHANGERS

3 speed a.t.c. change mixers for 7 in., 10 in., & 12 in.  
records, lightweight Xtal P.U. with turnover.  
One-point sapphire stylus for Hi-Fi reproduction.  
Latest models—Modern styling. All brand new,  
boxed and guar. A.C. 200/250 v. only.  
PLESSNEY, 88/10/- BSR MONARCH, 81 gns.  
CARBARIQ B4110, 89/10/- COLLARO R334,  
£10/10/- All suitable for our Radiogram chassis.



## QUALITY FLUORESCENT FITTINGS

Ideal for home or workshop. 4ft., 220-250 v.  
complete with tube, ballast unit, etc., ready  
for use. Famous manufacturer's surplus  
offered at approx. half price. Starter switch  
type, 42/- quick start type, 47/6. Carr. and  
ins., 7/6 extra.

## NEW BOXED VALVES GUARANTEED

1K5, 1T4 7/6	6AP6 9/-	6CX8 12/6	6E24 10/-
6K5, 184 7/6	6EP6 8/-	6EL80 12/6	6E24 10/-
281, 354 8/-	6K9 7/-	6E41 10/6	6MU4 8/6
5Z4 8/6	6L6 9/-	6EP5 10/-	6CC84 8/6
6AT5 8/6	6EA5 7/-	6EP50 10/6	6C80 12/6
6C16 10/6	6E91 7/6	6EP6 5/6	6C82 12/6
6HM 3/6	6E91 10/6	6EP8 10/6	6C83 12/6
6K7 6/6	6E93 8/6	6E85 10/6	6PL8 12/6
6K8 9/6	6E93 12/6	6E86 13/6	6PL8 10/-
6K7 8/6	6E94 13/6	6E89 10/6	6PL8 12/6
6N7 9/-	6E95 13/6	6E91 8/6	6PY8 11
6V6 7/6	6E96 12/6	6E41 11/6	6PY8 12/6
6X4 6/6	6E96 13/6	6E42 12/6	6PY8 2
6X5 8/6	6E42 10/6	6E51 12/6	6PY8 12/6

and hundreds of others at Bargain Prices.

## SPECIAL PRICE PER SET.

1K5, 1T4, 185, and 384 or 3V4 ... 27/6  
6K8, 6K7, 6Q7, 6V6, 5Z4 or 6X5 ... 35/-  
SPEAKER SET. Expanded Frouze analysed  
dwtal 8 in., x 8 in., 2 3/4 x 12 in., x 8 in., 3 - 12 in. x  
12 in., 4 3/4 x 12 in., x 16 in., 6 - 24 in. x 12 in., 8/6, etc.

## ELECTROLYTICS ALL TYPES NEW STOCK

Tubular Wire Ends	32 x 32 350 v. B.E.C. 5/6
25 25 v., 50 12 v.	1/9 Can Types, Clips, 3d. ea.
50 50 v., 4,500 v.	12/8 8 x 8 450 v. T.C.C. 4/6
100 25 v.	2/- 8 x 16 450 v. Hunts 5/-
2.450 v.	2/7 16 x 16 450 v. 5/6
8 450 v. B.E.C.	2/3 16 x 16 450 v. B.E.C. 5/6
8 x 8 500 v. Dub.	4/6 16 x 32 350 v. B.E.C. 5/-
8 x 16 450 v. Hunts	5/- 32/350 v. Dub. 4/6
16 500 v. B.E.C.	3/6 32 x 32 450 v. B.E.C. 6/8
16 500 v. Dub.	4/- 60/250 v. T.C.C. 6/8
16 x 16 450 v. B.E.C.	5/6 60 x 100 350 v. 11/6
32/350 v. Dub.	4/- 60 x 250 275 v. 12/8
32 500 v. Dub.	5/- 100 x 200 275 v. 12/8
50 x 50 350 v. B.E.C.	6/8 6,000 mid. 6 v. 3/9

## I.F. TRANSFORMERS—465 Kc/s

Brand new ex-manufacturer's midget I.F.T.,  
size 2 1/2 in. x 1 in. x 1 in., dust core tuning, Litz  
sound coils, High Q. Bargain offer, 7/8 pair.

## MAINS TRANSFORMERS.—Made in our own

Workshops to Top Grade spec. Fully interleaved  
and impregnated. RADIO AND AMPLIFIER  
TYPE.—250 v., 60 ma. F.W. sec. 5 v. or 6.3 v. 1 a.  
100 ft. 6 v. 2.5 a. set. HTs., 21/- etc. G.R.T. HTR.  
ISOLATION TYPE.—Low leakage with or without  
25% sec. boost voltage. Ratio 1:1 or 1:25, 2 v., 1 v.,  
5 v. or 13 v., 10 6 ea. Ditto with mains primaries  
200/250 v., 12/6. Special, to order. SPECIAL  
TYPES.—To designers spec. Victorator, 35/-  
Millard Amp, 35/-; Ornam 912, 35/- HEATER  
TRANS.—Prim. 200/250 v. 6.3 v., 11 a. or 4 v. 2 a.,  
or 12 v. 7.5 7/6; 6.3 v. 3 a. or 5 v. 3 a. 10/6.

## I.F. CHOSES.—10 H. 65 ma, 5/-; 15 H. 100 ma.

10/6; 10 H., 120 ma., 10/8; 20 H., 150 ma., 15/8;  
Simplex, 10/6; Soundmaster, 10/4. OUTPUT  
TRANS.—Standard pentode, 4/8; ditto tapped  
prim., 4/9; small pentode, 3/9; Midget battery  
pentode (184, etc.), 4/6.

## SOLOID SOLDERING IRONS (200-220 v. or 230-250 v.)

25 watt, instrument type, 21/-; 65 watt, Penic  
Bit Type, 26/8; 65 watt, Oval Bit Type, 25/-.  
Comprehensive stock of spares available.  
LOUDSPEAKER, P.M. 3 OHM, 5 in. (Celest), 17/6;  
4 in. (Celest), 18/6; 7 1/2 in. (Goodman's Special),  
18/8; 8 in. Elec., 20/-; 8 in. (Goodman's Special), 21/6;  
10 in. R. and A., 25/-; 12 in. Plessney, 35/-; 8 in.  
M.D. 2 k. ohms field, tapped O.P. trans., 24/6;  
2 1/2 in. Elec., 17/6.

## SCOTCH BOY, EMITAPE, etc. 30/-.

Long playing.  
TYPE II GLASS DIAL—Calibrated in Mers and  
illustrated with full details, 2/-, post free.



F.M. TUNER UNIT (87 mc/s—105 mc/s) by Jason.  
—As tested and approved by Radio Constructor.  
complete Kit of parts to build this modern highly  
successful unit, drilled chassis and J.B. dial, coils and  
cans, 4 B.V.A. miniature valves and all components  
etc., for only £6.10.0, post free. SUPERIOR  
TYPE II GLASS DIAL—Calibrated in Mers and  
illustrated with full details, 2/-, post free.

# TRS RADIO COMPONENT SPECIALISTS (Est. 1946)

70 BRIGSTOCK ROAD, THORNTON HEATH, SURREY (THO 2188)

50 yards Thornton Heath Station. Buses 130A, 133, 159, 166 & 190

Listed above are only a few items from our very large stock. Send 3d. stamp today for Complete Bargain list.

Hours: 9 a.m.—6 p.m. 1 p.m. Wed. OPEN ALL DAY SAT.

Terms C.W.O. or C.O.D. Kindly make cheques, P.O.s, etc. payable to TRS. Post/Packing up to 3 s. 6d., 11d., 1s., 31d., 1/6, 51d., 2/-, 101d., 2/9.

Great Britain's Valve Mail-Order House

DEMOWED VALVES MANUAL 2/6

Giving equivalents of British and American Service and Cross Reference of Commercial Types with an Appendix of B.V.A. Equivalents and Comprehensive Price List. We have still some Valves left at very old Budget Rates (33 1/3%) which are actually sold at the old price. (1951 rate).

TV BBC ITA CONVERTERS

Suit any A.C. Set. No Alterations. 25/- down and 6 monthly of 25/- or £7/10/- cash.

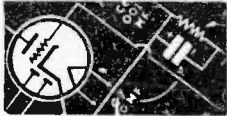

SERVICE SHEETS

The one you require enclosed if available. In a dozen assorted of our best choice. 10/6

32/6

Post 1/6



ALL MAINS THREE

Fine Midget 3-valve Mains Receiver. Home, Light, etc., at good strength. Build yourself - 3 valves, ready-wound coil, tuning condenser, mains transformer - everything except speaker and cabinet. Data av. sep. 2/- . Speaker and cabinet available if required.



.001-IN MICROMETER Brand new Precision Instrument BARGAIN 10/-

2000 BRITISH, AMERICAN, A.C. and UNIVERSAL TYPES. All fully Guaranteed FROM 2/-

074	6/-	6BH6	11/-	6BN7	11/-
01A	3/-	6B6	11/-	6BS7	8/-
1B4	9/-	6BW6	10/6	6BU7	9/-
1C6	9/-	6C4	7/6	6BV6	5/6
1D6	9/6	6C6	8/-	6BX4	10/-
1G4	8/6	6C8	11/-	6CX5	8/6
1H8	3/-	6D1	4/6	6ZY6	8/6
1L4	5/-	6D6	8/-	6X6	10/-
1LN5	6/8	6E5	11/-	7A7	9/6
1LA4	8/-	6F8	9/-	7B7	11/8
1LP5	6/8	6F82	6/-	7B8	10/-
1P5	9/-	6G6	8/-	7C5	10/-
1R4	9/6	6G7	9/-	7C7	9/6
1R5	9/-	6G7M	9/6	7D7	10/-
1R4	10/-	6K8	11/8	7E7	12/6
1R5	9/-	6L5	9/-	7F7	11/8
1T4	10/6	6L5	9/-	7G7	11/8
1T5	8/-	6K5	9/-	7K7	10/6
1U5	10/6	6K6	9/6	7A7	10/6
1V	7/-	6K7	9/6	7B7	10/6
2A3	10/-	6K8	11/8	7C7	10/6
2A6	2/-	6K82	11/8	7D7	10/6
2A7	6/-	6L5	9/-	7E7	10/6
2X2	6/-	6K5	9/-	7F7	10/6
3A4	9/-	6K6	9/6	7G7	10/6
3D6	7/-	6K7	9/6	7H7	10/6
3Q5	11/-	6K8	11/8	7J7	10/6
3R4	10/6	6K82	11/8	7K7	10/6
3V4	10/6	6L5	9/-	7L7	10/6
5T4	12/10	6K5	9/-	7M7	10/6
5U4	10/6	6K6	9/6	7N7	10/6
5X4	12/-	6K7	9/6	7P7	10/6
5Y3	11/-	6K8	11/8	7Q7	10/6
5Z3	11/-	6K82	11/8	7R7	10/6
5Z4	11/-	6L5	9/-	7S7	10/6
6A3	11/-	6L5	9/-	7T7	10/6
6A6	9/-	6K7	9/6	7U7	10/6
6AB7	9/6	6K8	11/8	7V7	10/6
6AB8	12/6	6K6	10/6	7W7	10/6
6AC5	9/-	6K7	9/6	7Y4	10/6
6AC7	8/6	6K7M	9/6	8A1	10/6
6AG5	9/-	6K8	11/8	8D2	10/6
6AG7	15/-	6L5	9/-	8D2	10/6
6A88	12/6	6K6	10/6	8E7	10/6
6AC5	9/-	6K7	9/6	8A	11/7
6AK5	10/-	6K7	9/6	8A	11/7
6AK6	9/6	6Q7	12/6	8A7	11/7
6AK7	15/-	6R7	7/6	8A7	11/7
6B1	9/-	6BA7	8/6	8A7	11/7
6B7	11/-	6B7	9/6	8A7	11/7
6B8	10/6	6B7	8/6	8A7	11/7
6BA6	11/6	6B7	8/6	8A7	11/7
6B86	9/6	6B7	8/6	8A7	11/7
6B86	9/6	6B7	8/6	8A7	11/7

RADIO BULLS VALVES



Deposit only & 8 monthly 10/9.4/- A.C. ELECTRIC PAINT SPRAYER. Just plug in and spray. Easier than a brush and twice as fast. Post 2/-.

Electric PAINT STRIPPER. Outdates blow-lamp. (No paraffin.) Fool-proof electric tool. Easier and faster. Clean and safe. Old paint goes like magic. Cost 1d. per hour. A.C./D.C. One year guarantee. 42/6 cash.



5/6 & 8 monthly of 5/6. CHASSIS CUTTERS WITH KEYS

The easiest and quickest way of cutting holes in sheet metal. The cutter consists of three parts: a die, a punch and an Allen screw. The operation is quite simple. Prices incl. key 4in., 12/4; 5in., 12/4; 6in., 12/4; 7in., 12/4; 8in., 12/4; 9in., 12/4; 10in., 12/4; 11in., 12/4; 12in., 12/4; 13in., 12/4; 14in., 12/4; 15in., 12/4; 16in., 12/4; 17in., 12/4; 18in., 12/4; 19in., 12/4; 20in., 12/4; 21in., 12/4; 22in., 12/4; 23in., 12/4; 24in., 12/4; 25in., 12/4; 26in., 12/4; 27in., 12/4; 28in., 12/4; 29in., 12/4; 30in., 12/4; 31in., 12/4; 32in., 12/4; 33in., 12/4; 34in., 12/4; 35in., 12/4; 36in., 12/4; 37in., 12/4; 38in., 12/4; 39in., 12/4; 40in., 12/4; 41in., 12/4; 42in., 12/4; 43in., 12/4; 44in., 12/4; 45in., 12/4; 46in., 12/4; 47in., 12/4; 48in., 12/4; 49in., 12/4; 50in., 12/4; 51in., 12/4; 52in., 12/4; 53in., 12/4; 54in., 12/4; 55in., 12/4; 56in., 12/4; 57in., 12/4; 58in., 12/4; 59in., 12/4; 60in., 12/4; 61in., 12/4; 62in., 12/4; 63in., 12/4; 64in., 12/4; 65in., 12/4; 66in., 12/4; 67in., 12/4; 68in., 12/4; 69in., 12/4; 70in., 12/4; 71in., 12/4; 72in., 12/4; 73in., 12/4; 74in., 12/4; 75in., 12/4; 76in., 12/4; 77in., 12/4; 78in., 12/4; 79in., 12/4; 80in., 12/4; 81in., 12/4; 82in., 12/4; 83in., 12/4; 84in., 12/4; 85in., 12/4; 86in., 12/4; 87in., 12/4; 88in., 12/4; 89in., 12/4; 90in., 12/4; 91in., 12/4; 92in., 12/4; 93in., 12/4; 94in., 12/4; 95in., 12/4; 96in., 12/4; 97in., 12/4; 98in., 12/4; 99in., 12/4; 100in., 12/4.

PIFCO All-in-one Radiometer A.C./D.C. \* Circuit Test. \* L.T. & H.T. Tests. \* mA Test. \* Valve Test. Continuity and Resistance Tests. Complete with Test Leads. 32/6 Post 1/-.

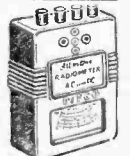

THE FAMOUS BENNETT COLLEGE

can train your mind to SUCCESS

THROUGH PERSONAL POSTAL TUITION

A FREE book vital to your career! Read how the famous Bennett College can help you to success! Send now for this recently published FREE book, "Train your mind to SUCCESS," which tells you about The Bennett College proven success in postal tuition... and how it can help you to success in your career.

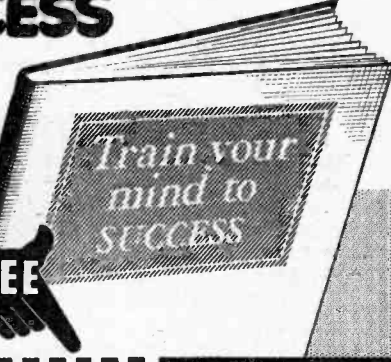

WHAT CAREER DO YOU WANT?

- Architecture
- Building
- Carpentry
- Chemistry
- Commercial Art
- Diesel Engines
- Draughtsmanship
- Electrical
- Engineering
- Electric Wiring
- Accountancy Exams
- Book-keeping
- Civil Service
- Commercial Arith.
- English
- General Education
- Geography
- Journalism
- Languages
- Forestry
- Locomotive Engineering
- Machine Design
- Mechanical
- Engineering
- Motor Engineering
- Plumbing
- Power Station Eng.
- Quantity Surveying
- Mathematics
- Modern Business Methods
- Police Subjects
- Salesmanship
- Secretarial Exams
- Shorthand
- Short Story Writing
- and many others
- Radio Engineering
- Sanitary Science
- Surveying
- Telecommunications
- Television
- Sanitary Science
- Surveying
- Telecommunications
- Television

FREE

TO THE BENNETT COLLEGE (DEPT. H.104-N), SHEFFIELD

Please send me, without obligation, a free copy of 'Train your mind to SUCCESS' and the College Prospectus on:

SUBJECT.....  
 NAME.....  
 ADDRESS.....  
 AGE (if under 21)..... Please write in block letters

THIS COUPON COULD BE YOUR PERSONAL PASSPORT TO SUCCESS. Send it NOW!

# Finding Transformer Connections

HOW TO IDENTIFY WINDINGS IN UNMARKED COMPONENTS

By F. G. Rayer

**M**ANY transformers from ex-Service and manufacturers' equipment have no markings, or only coloured leads to which no particular significance can be attached. Mains transformers, for example, not infrequently have no tag identification marks, in such cases being wired up from a plan showing tag positions. When such transformers have been taken from the equipment in which they were used, details of the voltage and current ratings of the various windings will often be lost so that the component is useless. However, if a number of systematic tests are made it is possible to identify the windings. This is a necessity with some ex-Service gear, and will also enable unidentified transformers from old receivers, etc., to be used.

Such tests are of two types, backed up by examination of the component. Resistance tests enable the tags going to various windings to be localised or separated, while A.C. voltage measurements allow a good idea of the ratio to be gained. Examination is particularly useful when the component is so constructed that the ends of the various windings can be seen issuing from the bobbin, usually to tags, so that the wire gauge is visible.

## Segregating Windings

The first step is to find what D.C. resistance exists between various tags or leads. A plan of the tags should be drawn, or the colours of leads noted. With the meter set to read resistance a continuity test is made between each tag and all other tags in turn. If the meter gives no reading, no winding is present between the pair of tags to which the prods are taken. A fairly high-resistance reading shows a large winding; a low-resistance reading shows a

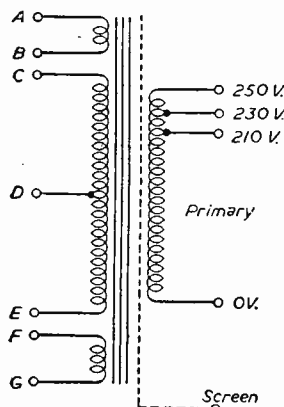

Fig. 1.—Circuit obtained from resistance tests.

winding. The path from "F" to "G" is again of low resistance, and no continuity exists between these and any other tags.

small winding, probably of stout wire. A circuit of the component can be drawn as these tests proceed, and it will show all windings with connections.

An example of this is given in Fig. 1. Here "A" is only continuous with "B", resistance being low. "C," "D" and "E" are all continuous, resistance being moderately high, and it is found that the resistance reading from "D" to "C" or "D" to "E" is the same, being half that from "C" to "E." Tag "D" must therefore be a centre-tap on this

All the primary tags are continuous but a fairly high resistance exists between 0 and 210 volt points, with a much lower resistance between 210 volt, 230 volt and 250 volt points. These relative resistance values mean no centre-tap is present, even if only one extra tag such as that for 230 volts were present. The tentative diagram of windings as in Fig. 1 can thus be drawn.

A screen may not be present. If it is, it may be identified as a strip of foil emerging from between the windings. If not, then any isolated tag will be the screen. If two isolated tags are found they are probably those of a burnt-out winding and can be disregarded.

When tests have revealed a circuit such as in Fig. 1 it is safe to assume that the winding with a number of tappings near one end must be the primary, and to

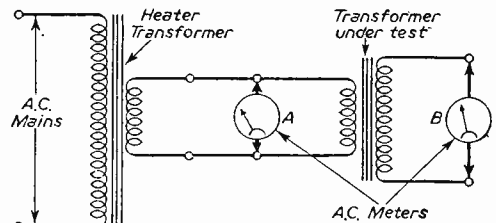

Fig. 2.—Determining ratio.

apply an A.C. mains supply to those two tags between which most resistance exists. That is, 0 and 250 volt points.

In many instances the voltage outputs of the secondaries can now be read at once with an A.C. meter. For example, "A" to "B" may be 5 volts, clearly for a 5 volt rectifier. "D" to "C" or "D" to "E" might be 250 volts or 350 volts, for example, indicating a 250/0/250 volt or 350/0/350 volt H.T. secondary. Between "F" and "G" 6.3 volts might be found, showing this is for receiver heaters.

Other voltages may, of course, be found, especially in old transformers where 4 volt windings are usual. Other transformers may have two 6.3 volt windings for a 6.3 volt rectifier. In any case, this will be shown by the meter reading. If readings are a trifle under those anticipated, then the primary input connection can be modified to remedy this. Low-voltage secondaries will almost without exception be 4 volt, 5 volt or 6.3 volt. It is best to begin with the full primary in circuit in case the transformer is wound for 230 volts or other voltage under that found in some areas.

## Current Ratings

If none of the wire is visible, it may be necessary to try the transformer with a fairly low load, increasing this until it grows just warm to the hand after 30 to 60 minutes, when the full rating has probably been approached. With average transformers, a 5 volt

winding is usually rated at 2 or 3 amps for a rectifier. A H.T. secondary is seldom rated at under 60 mA. A 6.3 volt secondary may be able to deliver anything from about 1½ amps to 3 amps or more, according to the type of equipment.

If the winding wires are visible, as when they emerge and are soldered to tags, then the wire gauge can be ascertained, and the maximum current rating of the winding can then be found from a wire table. Wires frequently encountered in average mains transformers, with approximate current rating, are as follows:

Heater Windings		
14 s.w.g.	—0.08in. diameter—	5 amps.
15 "	—0.072in. "	4 "
16 "	—0.064in. s.w.g.	3 "
17 "	—0.056in. "	2½ "
18 "	—0.046in. "	1½ "
20 "	—0.036in. "	1 amp.

H.T. Secondaries		
30 s.w.g.	—0.0124in. diameter—	120 mA.
32 "	—0.0108in. "	80 "
34 "	—0.0092in. "	60 "

**Ratio Tests**

When finding connections for mains transformers the ratio does not need to be considered. Knowledge of this figure is necessary with other transformers, however, and the relative D.C. resistance of the windings will not give an indication of the number of turns, due to the use of different gauges of wire for

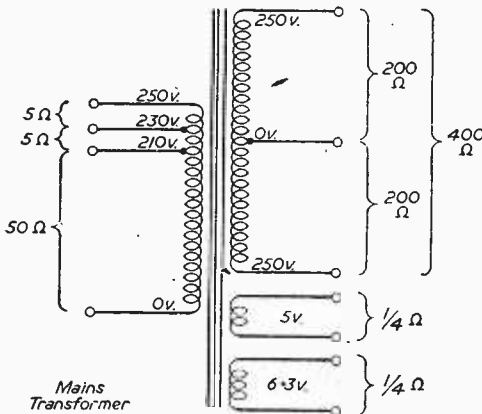

Fig. 4.—Mains transformer resistance readings.

each winding. A good idea of the ratio may be found by the test shown in Fig. 2, and this is particularly useful for output transformers or other A.F. components.

One winding is energised by a source of low-voltage A.C. such as can be derived from a 4, 5 or 6.3 volt heater secondary. Such a voltage may be applied to any coupling or output transformer without damage. The voltage applied is measured with an A.C. meter, and the ratio is the same as the relationship between this reading and that obtained at the other winding, e.g., in Fig. 2 5 volts is read at "A" and 15 volts at "B"; the ratio is thus 5 : 15, or 1 : 3.

The cheap type of A.C. meter, which draws a heavy

current, is not satisfactory for this type of test, and a radio type testmeter should be used. With output transformers, microphone transformers, or other transformers of high ratio, a very large difference in input and output voltage will be obtained. For example, a 1 : 50 transformer would develop 250 volts in its secondary, if 5 volts were applied to the primary, and damage might arise, especially if the circuit is kept closed for any length of time. Such danger can be avoided by applying the A.C. input to the *highest resistance* winding, to obtain a step-down of voltage. With 5 volts only .1 volt would arise in the secondary, so that with transformers of such high ratio it may be necessary to apply a higher voltage to get a good reading. Whether or not this is necessary will become at once apparent after an initial test with a low

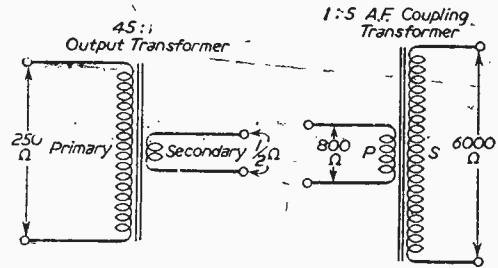

Fig. 3.—Typical resistance reading.

voltage. With a multi-ratio output transformer it will be quite easy to distinguish between the various tappings provided. The current the primary can carry can be found by reference to the wire gauge, if necessary.

Though this method does not indicate the impedance of the windings, it does, nevertheless, allow many unknown transformers to be tested and brought into useful service.

Transformers of popular types are shown in Figs. 3 & 4, together with average resistance values. These values will not necessarily be encountered in other components, but will act as a guide to the kind of resistance readings to expect. They also show how easily centre-taps can be distinguished. One-half of any centre-tapped winding is frequently very slightly higher in D.C. resistance than the other, because the turns forming it are wound at a slightly larger diameter during construction.

**PRACTICAL TELEVISION JULY ISSUE NOW ON SALE PRICE 1/3**

An article dealing with the tracing of faults without the usual Servicing equipment forms the main feature of the current issue of our companion paper now on sale. In addition there is a constructional article on a new Band III Converter, employing an EF80 and an ECF82 valve. Other articles include the fourth in the series covering a Beginner's Guide to Television; a further chapter dealing with the principles and practice of Colour television; Servicing Notes for the Regentone Big 12, and some further notes on the Oscilloscope for TV which was described in recent issues. Other articles deal with the I.T.A. Northern Region Transmitters, an Analysis of Viewing Audiences, Telenevs, Correspondence, Underneath the Dipole, and Readers' Problems Solved.



# COMPLETE KITS of PARTS for the "Hi-Fi" ENTHUSIAST

**THE MULLARD "5-10" MAIN AMPLIFIER**

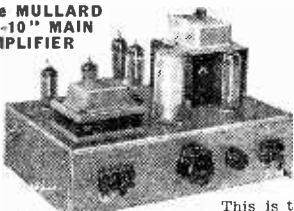

This is the very latest design and needs no recommendation from us. Our Kit is complete to Mullard's specification, including the latest GILSON ULTRA LINEAR OUTPUT TRANSFORMER and the entire MULLARD Valve line up. ALL SPECIFIED COMPONENTS are supplied. **PRICE OF COMPLETE KIT OF PARTS £11.10.** (Plus 5/- carr. and ins.)

**THE FULL SPECIFICATION AND BUILDING INSTRUCTIONS** for these three Units are available for 1/6 each. THEY include COMPONENT PRICE LISTS and simple "wire-to-wire" PRACTICAL DIAGRAMS.

**STERN'S "fidelity" PRE-AMPLIFIER-TONE CONTROL UNIT**

"A design for the music lover"

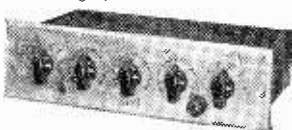

Briefly it has inputs for all types of MICROPHONES, HIGH and LOW GAIN PICK UPS, and a RADIO TUNING UNIT. It incorporates (a) GRAM EQUALISING CONTROL. (b) STEEPCUT FILTER. (c) Continuously variable BASS and TREBLE CONTROLS and a variable OUTPUT CONTROL, which enables its use with any type of Amplifier.

**PRICE OF COMPLETE KIT OF PARTS (Plus 5/- carr. and ins.) WE ALSO OFFER IT ASSEMBLED, READY FOR USE, £8.** (Plus 5/- carr. & ins.)

**STERN'S HIGH QUALITY 8-10 WATT POWER AMPLIFIER**

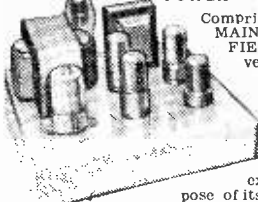

Comprises the MAIN AMPLIFIER of our very popular 8-10 watt design, which we have modified with the express purpose of its use with the "fidelity" PRE-AMPLIFIER illustrated alongside. TWO 6V6's are used in push-pull and the resultant reproduction is genuinely in the HIGH fidelity class, yet the total cost is ridiculously low.

**PRICE OF COMPLETE KIT OF PARTS (Plus 5/- carr. & ins.) (Main Amplifier only.)** THEY include SPECIFIED COMPONENTS to build this complete KIT OF PARTS available for 1/6 each. **THEY include** PRACTICAL DIAGRAMS.

## SPECIAL PRICE REDUCTIONS . . . FOR PURCHASERS OF A COMPLETE "HI-FI" AMPLIFIER

WE WILL SUPPLY (a) COMPLETE KIT OF PARTS to build THE MULLARD "5-10" MAIN AMPLIFIER and the STERN'S "fidelity" PRE-AMPLIFIER-TONE CONTROL UNIT for £16/16 - (plus 7/6 carr. and ins.), or we will supply THE TWO UNITS MADE UP and READY FOR USE for £18/19/- (plus 7/6 carr. and ins.). Terms : Deposit £9/19/- and 12 monthly payments of 18/7 or £5/-/- Deposit and 9 months of £1/16/7. (b) COMPLETE KIT OF PARTS to build the HIGH QUALITY 8-10 WATT POWER AMPLIFIER and the "fidelity" PRE-AMPLIFIER-TONE CONTROL UNIT for £13/-/- (plus 7/6 carr. and ins.) or we will supply THE TWO UNITS MADE UP and READY FOR USE for £15/15 - (plus 7/6 carr. and ins.). Terms : Deposit £7/17/6. 10 monthly payments of 17/9, or £4/-/- deposit and 9 months of £1 8/9.

**QUALITY OF THIS NATURE HAS NEVER BEFORE BEEN OFFERED AT SUCH LOW COST.**

## AN EXCEPTIONAL OFFER FOR CASH ONLY £7.19.6.

The "B.N.R. MONARCH 3-SPEED AUTOCHANGER NORMAL" PRICE £13/10/-.

- Complete with High Fidelity Crystal "Turn-over" Head which incorporates separate stylus for L.P. and 78 r.p.m. records. ● A "MIXER" Unit that will autochange on 7in., 10in. and 12in. records.
- Brand New in Maker's Cartons, complete with mounting instructions.

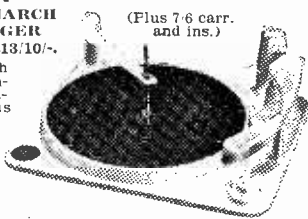

(Plus 7/6 carr. and ins.)

## DESIGNS FOR THE HOME CONSTRUCTOR

THE COMPLETE SPECIFICATIONS OF THE FOLLOWING UNITS ARE AVAILABLE FOR 1/6 EACH.

THESE MANUALS ALSO INCLUDE THEORETICAL AND PRACTICAL WIRING DIAGRAMS, AND A COMPLETE COMPONENT PRICE LIST.

The "wire-to-wire" Practical Diagrams are very simple to follow and are drawn for the "inexperienced" Constructor.

- STERN'S F.M. TUNING UNIT . . . A 5-valve Tuner incorporating the latest Mullard Permeability Tuning Heart and a "Magic Eye" Tuning Indicator and can be completely built for £10/-/- It is now available.
- STERN'S COMBINED A.M. F.M. TUNING UNIT . . . Precisely similar to the F.M. Tuner, but also incorporates the MEDIUM WAVEBAND. It can be completely built for £13/-/-.
- THE DENCO F.M. TUNING UNIT . . . The complete set of SPECIFIED COMPONENTS to build this can be supplied for £7/9, this includes the Denco Dial and Drive Assembly.
- STERN'S HIGH QUALITY 8-10 WATT AMPLIFIER . . . Designed for High Quality reproduction up to an output level of 10 watts, having 6V6's in Push-Pull and incorporating negative feedback. It is one of the most successful Amplifiers (in the lower price range) yet offered to the Home Constructor. WE can supply the complete Kit ex-stock.
- STERN'S "JUNIOR" PRE-AMPLIFIER-TONE CONTROL UNIT . . . Provides full control of BASS and TREBLE in conjunction with main VOLUME CONTROL and can be used with any Amplifier. The unit contains its own POWER SUPPLY . . . THE COMPLETE KIT OF PARTS is available at £3/16/9.
- STERN'S "PERSONAL SET" BATTERY ELIMINATORS . . . Complete Kits of PARTS to build Midget "All-dry" Battery Eliminators (a) Providing approx. 69 Volts at 10 ma and 1.4 Volts at 250 m a. Price £2 6/- (b) Providing approx. 90 Volts at 10 ma and 1.4 Volts at 250 m a. Price £4 7/6.

ALL COMPONENTS TO BUILD THESE AMPLIFIERS, TUNERS, ETC., ARE AVAILABLE FOR SALE SEPARATELY. CONSTRUCTORS CAN, THEREFORE, GRADUALLY BUILD ANY UNIT.

## A REALLY GENUINE PRICE REDUCTION

A BULK PURCHASE ENABLES US TO OFFER THESE RECIPIVER CHASSIS AT SUCH LOW PRICES. Each is BRAND NEW and FULLY GUARANTEED.

The MODEL R.3 5-valve 3-waveband A.C. mains Superhet. Designed to the most modern specification, great attention having been given to the quality of reproduction which gives excellent clarity of speech and music on both gram. and radio, making them the ideal replacement chassis for that "old radiogram," etc. : Valve Line-up. 6BE6-6BA6-6AT6-6BW6-6X4; coverage : S.P.T. 16-50, med. 187-550, lg. 900-2,000 metres. (Plus 7/6 carr. & ins.) H.P. Terms : Deposit £11.11.0. (plus 7/6 carr. & ins.) 7 monthly payments of 19/3.

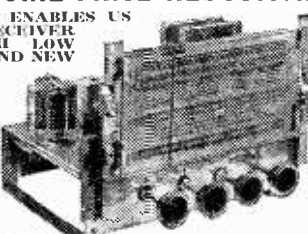

- (a) The "COMPACT 5-2" A Two-stage high sensitivity Amplifier having SEPARATE BASS and TREBLE CONTROLS and designed to give up to approx. 5 watts with very pleasing quality. PRICE £5/15/- (plus 5/- carr. and in.).
- (b) The "COMPACT 5-3" A Three-stage version of the "5-2" model, but in this case having an additional stage and incorporating Negative Feedback. PRICE £6 16/- (plus 5/- carr. and insurance).

The Amplifiers are compact and very attractively designed, having a Bronze Gold finish with a fully engraved front panel by which the entire Amplifier is conveniently mounted into a Cabinet, thus occupying no more space than a conventional Tone Control Unit.

## STERN'S "COMPACT 5" AMPLIFIERS

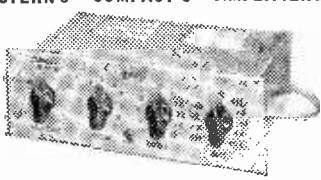

Expressly developed for very high quality reproduction of Gram. Records and particularly suitable for high quality reproductions of the F.M. transmissions. Two models are available - A separate "POWER SUPPLY UNIT" to operate with these amplifiers is available for £2 10/- (plus 2/- carr. & ins.). Has additional supply available for Radio Tuner, etc.

**STERN RADIO LTD. 109 & 115 FLEET STREET, LONDON, E.C.4.**

Telephone : FLEET 5812/3/4



## Set to go Places with you The SUPEREX "55" Battery Portable

A first-class receiver guaranteed to give good reception throughout the country. Equal in appearance and performance to most commercial models. Cabinet size 10 $\frac{1}{2}$  in. x 8 $\frac{1}{2}$  in. x 5 in. All parts available separately.

- Four Valve Superhet
- Long and Medium Wave
- Large Elliptical Speaker
- B7G 1.4V Miniature Valves
- Simple Construction

**ONLY £7. 15. 0**  
Plus 3/6 p.p.

Send 1/6 for Superex Construction Booklet.

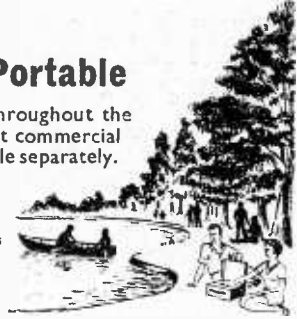

### CABINET SNIP



PRICE  
**15/6**  
P.L.S. 2/6  
D.D.

Bakelite cabinet ideal for midget construction. Available in Walnut or Green. Size 12in. long, 7in. high, 5 $\frac{1}{2}$ in. deep. Complete with handle, back, dial and 2 knobs.

### RADIO COMPONENTS

We carry a wide range of Radio and Television components, also AM/FM Radio Chassis, Tuners and HF Amplifiers. Quality Speakers always in stock — send for lists!

**Superior**  
*Radio supplies*  
37 HILLSIDE, (HARROW ROAD)  
STONEBRIDGE, N.W.10. Elgar 3644

### THE "ARGONAUT"

**AM/FM TUNER RECEIVER**  
A VHF and Medium Wave Tuner or Receiver from the manufacturers of the very successful Jason FM Tuner. Provision is made for accommodation of a power pack and output stage on the same chassis. All parts are available separately and include everything down to the last nut and bolt. Valve line-up: (3) EF80, ECH81, 6BA6, EABC80, 6AQ5, EZ80 and DM70. Building cost approximately £15.15.0, including power pack and output stage.  
SEND 2/- FOR BOOKLET.

SHOP OPEN : 9 a.m. to 6 p.m. Monday to Saturday; 1 p.m. Thursday.  
TERMS : Cash with order or C.O.D. (U.K. and N. Ireland only).

## LASKY'S RADIO

### 3-WATT MIDGET AMPLIFIER

A.C./D.C., very high gain. 4 valves: 2 UL41 (p.p.), UCH42, UAF42. Input voltage 100/100, easily converted to 230v. Ideal for record players, recorders, baby alarms, etc. Fully assembled, with valves and circuit diagram.  
REDUCED TO **50/-**  
Carr. 5/-.

### COMPLETE 5-VALVE RADIO CHASSIS

Brand new and unused. A.C./D.C. 200/250 volts. I.F. 465 kc/s A.V.C., 4 watts output, 3-station pre-set, frame aerial fully aligned, chassis 10 x 5 $\frac{1}{2}$  in. max. height 5 $\frac{1}{2}$  in. Completely wired and ready for use, with the addition of a speaker and output transformer. Two controls, volume and station switch. Valves used: 10C1, 10F9 or UF41, 10LD11, 10F14, U404 or UY41.

LASKY'S PRICE **52/6**  
less valves. Post 3/6 extra.

### METER BARGAINS

2 $\frac{1}{2}$  in. Moving Coll. Brand new Microammeters F.S.D. 0-750 micro/amps. 15 ohms rest. ... **15/-**

T.O. CRYSTAL P.U. CARTRIDGES. ACOS H/G type HGP.37 as used in latest radiograms. L.P. and standard, with styl. **22/-** Post 1/-.

B.S.R. Crystal Cartridges, 18 6. post 1/-.

### SPECIAL OFFER! GARRARD RC.110 3-SPEED AUTO-CHANGERS

Brand new in maker's cartons. Complete with turnover crystal pick-up. Incorporates automatic record size selection (mixer). Cabinet space required: 14in. x 12 $\frac{1}{2}$ in. x 49/16in. above and 2 $\frac{1}{2}$ in. below motor board. Cream and Brown enamel finish. Limited quantity only.  
List £14.13.0. LASKY'S PRICE **£8.19.6**  
Carr. 5/-. Cabinets available.

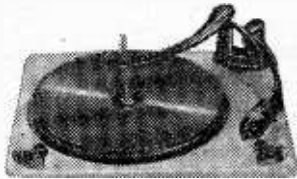

### BIGGEST BARGAIN EVER OFFERED IN TV CATHODE RAY TUBES!



### 16" METAL CONE C.R.T.

C.3 v. heater. Ion trap, 14 Kv. E.H.T., wide angle 70°, standard 38 m.m. neck, duodecal base, magnetic locus and deflection. Length 17 11/16in. Gives large black and white picture 11in. x 11in.

Unused in original cartons. Guaranteed by us 3 months. Full data, connections and suggested time bases supplied with every Tube.

LISTED AT **LASKY'S PRICE £9.19.6**  
**£23.9.10**

Carr. & Insur., 22/6 extra

Big Picture TV at a Price You Can Afford!  
Masks, Anti-Corona Rings. Bases and Ion Traps available.

B.S.R. MONARCH 3-SPD. AUTO-CHANGERS **£7.19.6**  
Carr. 3/6.

Open all day SAT. Half day Thurs.

PLEASE ADDRESS ALL MAIL ORDERS TO HARROW ROAD  
**LASKY'S (HARROW ROAD) LTD.**  
42, TOTTENHAM COURT ROAD, W.1.  
Telephone : MUSEUM 2605.  
370, HARROW ROAD, PADDINGTON, W.9.  
LADbroke 4075 and CUNningham 1979.

### RECORDING TAPE

SPECIAL OFFER. Magnetic Recording Tape, kraft base, on Cylind metal spools.  
1,200 ft. **11/6.**  
100 ft. **7/6.**

On plastic spools,  
1,200 ft., **12/6.**  
100 ft., **9/6.**

PURETONE TAPE, on plastic spool,  
1,200 ft., **14/11.**  
Post 1/- extra.

### TAPE DECKS

Large range including Collaro, Truvox, Lane, Brenell, etc., in stock.

# BUILDING A CONSTANT VOLTAGE TRANSFORMER

A USEFUL CONSTANT VOLTAGE SOURCE

By A. M. St. Clair

AS a glance through the advertisement columns of this journal will show, it is now possible to purchase a good range of test equipment at extremely reasonable prices. Pattern generators, signal generators, signal tracers, to name but a few, can be obtained for surprisingly small sums. Now, while these instruments are often very good value for money, neither they nor their home-made counterparts can fairly be expected to give a performance comparable to that of equipment designed for the same purpose but costing perhaps five or ten times as much. It is possible, however, to effect some improvement in the operation of these simple pieces of apparatus by running them from a constant voltage source. It is the object of this article to show that such a source need be neither expensive nor difficult to build.

The high cost of commercial constant-voltage transformers arises chiefly from three factors: first, the variable nature of even the best magnetic materials, which makes it necessary to give each transformer a certain amount of skilled individual attention; second, the use of high-voltage A.C. working condensers, and, third, the incorporation of tuned filters to improve the wave-form arising from the employment of the saturation principle. The first is obviously of little moment to the man who wishes to construct one only, and the limitations imposed by the third are, for our purposes, small. The second is eliminated altogether in the following design, since it uses no condensers whatsoever.

Fig. 1 shows the relationship between current and voltage in an iron-core inductor, e.g., the primary of a mains transformer. The curved shape, which is the result of the iron becoming saturated, means that beyond a certain input voltage there is a disproportionate increase in current; this increase is capable of wreaking rapid destruction, and is the reason why power transformers are less tolerant of overload than almost any other component. It is also the basis of the theory upon which the constant-voltage transformer depends.

Suppose that a resistance is connected in series with the inductor. The rate at which the current can rise with increasing applied voltage is now limited, and

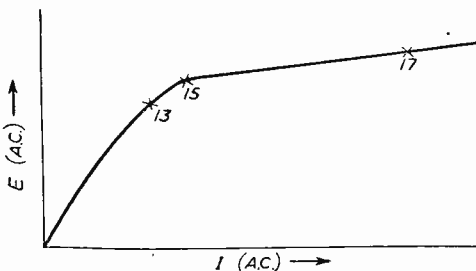

Fig. 1.—Current voltage relationship with iron-core inductor.

therefore the rate of change of voltage across the inductor is also limited. Here we have a rudimentary stabilised transformer system. But, although it demonstrates the principle, it would be inefficient, since the resistance would dissipate power, and it is not now used in practice. Instead of a resistance we find a non-dissipative component—i.e., a condenser or a choke.

Fig. 2 shows on the same diagram the voltage current

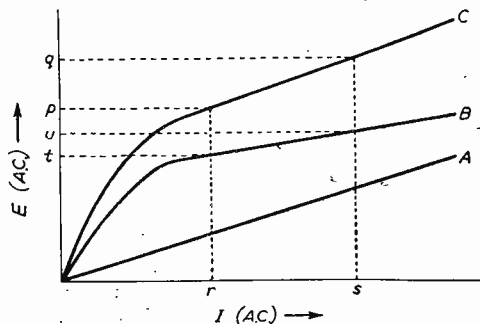

Fig. 2.—Current voltage relationship for various conditions.

curves for a linear choke, i.e., one whose core is not allowed to run into saturation (A); a saturating transformer primary (B); and for the pair in series (C), which is obtained by adding the voltages across the other two. It will be noticed that the curve C has no sharp current run-off, as did that of the transformer alone; in fact, it tends to become parallel to curve A. The sum of the voltages across choke and transformer is of course the mains input voltage. Suppose that this voltage changes from the value  $p$  to the value  $q$ , Fig. 2. This will result in a current change from  $r$  to  $s$ , which means that the voltage on the transformer primary changes from  $t$  to  $u$ —obviously a very much smaller change, not only in absolute value but also a smaller percentage change. Not true constant voltage yet. But now suppose that we wind a small secondary on the choke, and arrange it so that it produces a voltage change equal and opposite to that on the transformer primary. All we now have to do is to connect this in series with the saturating coil, and the net output will be constant. The arrangement is shown in Fig. 3 and the relative graph in Fig. 4. This circuit has the snag that it always gives an output at lower voltage than the mains, and so in practice the modified version of Fig. 5 is adopted; here the output from each component is stepped up so that the difference between them is equal to the desired voltage. The curves of Fig. 4 still apply, of course, each output being increased in the same proportion.

### Construction

Thus the constant voltage transformer in theory; and so to constructional details. Reference to Fig. 1

will show that flux densities are marked at three points, 13, 15 and 17. These densities are in Kilolines per square cm. For average good quality core materials the knee of the curve is at about 15Kl/sq.cm., as shown. An ordinary mains transformer is seldom worked higher than 13Kl/sq.cm., and the best ones often considerably lower. Constant voltage transformers, however, have to work at densities of 15-17Kl/sq.cm., and this is the region in which we are interested. Now, the formula connecting turns-per-volt with flux density is:  $t.p.v. = 70/a.B.$ , where  $a$  is the core area and  $B$  is the required flux density. (This formula is for 50 cycles per second only.) Let us take a central mains figure of 240 volts, and a flux density at this voltage of 16Kl/sq.cm., and assume that the laminations are of a type having a centre limb  $1\frac{1}{4}$  in. broad, for example the very common type 460A. Stacked to give a square centre limb, we have  $a = 1\frac{1}{4} \times 1\frac{1}{4}$ , approximately  $1\frac{1}{2}$  square inches. Since the formula given uses  $a$  in square inches and  $B$  in Kl/sq.cm., we put these figures in direct, and get:  $t.p.v. = 70/16 \times 1\frac{1}{2}$ , which is nearly enough 3. Using a core of exactly the same size for the choke, but selecting a flux density of 8Kl/sq.cm., since it must never be anywhere near saturation, we obtain for this component  $t.p.v. = 6$ . It has been found satisfactory in practice to allow the saturating transformer to take 2/3 of the mains voltage and the choke 1/3 at the centre voltage; hence, in the case under consideration, the basic figures for transformer and choke will be 160 volts and 80 volts respectively. This gives the transformer 480 primary turns and the choke the same number. With regard to wire size, it is as well in these instruments to use the largest size possible; it will be found that about 1/3 of the window space is available for the primary on the transformer, and about 2/3 on the choke. This means that, using 460A laminations, you will be able to use 20 gauge enamel and 17 gauge enamel, respectively.

#### A Practical Task

It is impossible to calculate the secondary turns by theory alone. Any attempt to do so will inevitably result in failure. The next step is, therefore, a practical bench job, and the care and accuracy with which it is accomplished will determine the success of the finished instrument. First wind the primaries. Bobbin construction is recommended, though not essential.

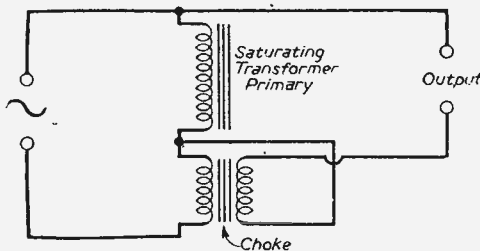

Fig. 3.—Secondary wound on choke and connected in series with saturating coil.

Next, assemble them on the cores: the saturating transformer is fully interleaved, and the choke has all the "T's" facing one way and all the "U's" the other (or, of course, "E's" and "I's" if these are chosen). Fine tissue paper is inserted in order to gap the choke, as in Fig. 6. Both components are now

fitted with the same clamps with which it is intended to furnish them in the finished job. The choke clamps may be of brass, aluminium or tufnol, but *not* of iron or steel. Having clamped the cores firmly—and really good clamping is essential, particularly in the case of the choke—and having "bedded down" the choke gap, connect the two in series and apply the selected centre voltage, in our example 240 volts. If

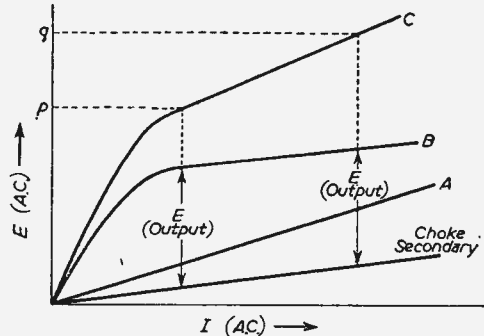

Fig. 4.—Graph of results obtained by a set-up as in Fig. 3.

the mains is within two per cent. of the selected value, use the mains, otherwise your best course is to wait for an occasion when it is within these limits. (You should, of course, select for your centre working voltage the nominal supply voltage of your locality.) There is no objection, however, to the use of a suitable tapped transformer to achieve the correct voltage for this part of the work, provided that it is of really good construction and has a core area two or three times as great as that of the parts under construction. Now measure the voltages across the choke and saturating transformer primaries. The object is to adjust the choke gap until these voltages are correct.

#### Golden Rules

In the example taken we want 160 volts and 80 volts. The method is as follows. If the choke voltage is too great the gap must be increased, if it is too small the gap must be reduced. To increase it, use thicker material and vice versa. Try to arrange things so that the gap filler does not use more than two layers; if you find that six layers of tissue paper comes out right, look around for something with which to achieve the same thickness in one or two layers. This is in the interests of long-term stability. Any non-ferrous material may be used and, though they involve theoretically a small loss, metallic foils can be quite serviceable. The golden rules for this part of the process are; *never* attempt to adjust the gap with the power on and *always* see to it that the gap is well bedded down, and the whole choke firmly clamped up, before reconnecting the power. Otherwise, windings will be damaged and fuses blown. You should work up from the thinnest possible gap until the correct result is obtained.

Next, leaving the finally-arrived-at gap undisturbed, we must measure the performance of the primaries on varying voltage. For this purpose you will need a mains transformer of the variety having three input taps. Most of us have one or two lying around, so select the largest available. The taps are normally spaced at 20 volts intervals, and this is perfectly satis-

(Continued on page 413)

# HENRY'S

(RADIO LTD.)

**CATHODE RAY TUBES**  
(Brand New)  
VCR97 (slight cut-off) 15/-  
VCR97 guaranteed full T.V. Picture ... 40/-  
VCR517C, guaranteed full T.V. Picture ... 35/-  
VCR139A, guaranteed T.V. Picture... 35/-  
VCR138A (with Screen) ... 35/-  
3BP1, guaranteed full T.V. Picture... 30/-  
Carr. & Packing on all tubes, 2/-

**"38" WALKIE-TALKIE SETS**  
Special offer of above set, complete with 3 valves, 4 ARP12 and ATP4 with circuit. Range 7.4 to 9 m.c.s. These sets are not guaranteed but are serviceable. 25-  
Junction box 2/6 extra.

**PYE 45 MC.S. STRIP TYPE 3582 UNITS**  
Complete with 45 Mc s Pye Strip, 12 valves : 10 EF50, EB34 and EA50, volume controls, and hosts of resistors and condensers. New condition. Modification data supplied. Price 69 6, carriage paid.

**62A INDICATOR UNIT**  
Containing VCR97 with Mu-metal screen, 21 valves: 12-EF50, 4-SP61, 3-EA50, 2-EB34. Thus 4 pots, switches, H.V. cond., resistors, Muirhead S M dial, double deck chassis and crystal. BRAND-NEW ORIGINAL CASES, 67-6, carriage 7-6.

**TRANSISTORS** **TRANSISTORS**  
**JUNCTION TRANSISTOR TYPE (P.N.P.)**  
This Junction Transistor is designed for audio-frequency amplification, although its frequency response makes it suitable for intermediate frequency and switching applications, together with many other uses, e.g., Local Station Receiver, Transistor Voltmeter, Signal Tracer, Oscillators, Experimental Work, etc. (Circuit supplied.)  
**DUE TO A LARGE PURCHASE, WE CAN OFFER THESE TRANSISTORS (A PRODUCT OF WELL-KNOWN MANUFACTURER) AT THE VERY LOW PRICE OF:— 10/- EACH Working.**

**INDICATOR UNIT TYPE 182A**  
Unit contains VCR517 Cathode Ray 6in. tube, complete with Mu-metal screen, 3 EF50, 4 SP61 and 1 5U4G valves, 9 wire-wound volume controls and quantity of resistors and condensers. Offered BRAND NEW (less relay) at 67 6 plus 7/6 carr. Radio Constructor's scope circuit included.

**U.S.A. INDICATOR UNIT TYPE BC929A**  
In black cracked cabinet 14 1/2 in. x 9 in. x 9 in. Complete with 3BP1 C.R. Tube, shield and holder, 2 6SN7GT, 2 6H6GT, 1 6X5GT, 1 2X2, 1 6G6, V/controls, condensers, etc. Ideal for 'scope. Brand new, 65/-, carriage paid.

**MINIATURE I.F. STRIP TYPE "373" 9-72 ME4.**  
Brand new miniature I.F. Strip size 10 1/2 in. x 2 1/2 in. x 3 in. high. Valve line-up: 2 EF92 : 3 EF91 and EB91. With Circuit. Price (less valves), 7 6. P.P. 1/6.

**VR91A The Selected EF50.**  
Brand New Red Sylvania original cartons, 10/- each, 90/- for ten.

**SPECIAL REDUCTION FOR SETS OF VALVES**  
1A7GT, 1N5GT, 1B5GT, 1A5GT, (or 1Q5GT or 3Q5GT) 37/6 Set  
10 EF50 (Ex-Brand New Units), 5/- each ... .. 45/- ..  
6K9G, 6K7G, 6Q7G, 5Z4G, 6V6G ... .. 35/- ..  
1R5, 1S5, 1T4, 1S4 or (3S4 or 3V4) ... .. 27 6 ..  
DK96, DF96, DAF96, DL96 ... .. 32 6 ..  
We have over 50,000 valves in Stock at more than 50% off.  
SEND 3d. for 28-PAGE ILLUSTRATED CATALOGUE.

**CRYSTAL MICROPHONE INSERTS**



5/- POST FREE  
5/- POST FREE  
Ideal for tape recording and amplifiers. No matching transformer required.

**QUARTZ CRYSTALS**  
Type FT243 Fundamental Frequencies, 2-pin 1/2 in. Spacing. 120 Types : 5675 Kc/s to 8650 Kc/s (Channel 270.389). (In steps of 25 Kc.s.). 60 Types : 5706.667 Kc/s to 8340 Kc.s. (Channel 0/79). (In steps of 33.333 Kc.s.)  
**BRAND NEW AND GUARANTEED, 10/- each.** Complete sets of 80 and 120 Crystals available.

**Type FT241A 54th Harmonic**  
2-Pin 1/2 in. Spacing  
**80 TYPES** : 20 Mc's—27.9 Mc's. (In steps of 100 Kc.s.)  
**BRAND NEW AND GUARANTEED, 7 6 each.** Complete Sets of 80 Crystals Channel 0/79 available. 20 Kc. s. 10/- each. CRYSTAL HOLDERS, 1.3 each. 10% Discount on all orders of 25.

5, HARROW ROAD, PADDINGTON, LONDON, W.2

TEL : PADDINGTON 1003-9, 0401

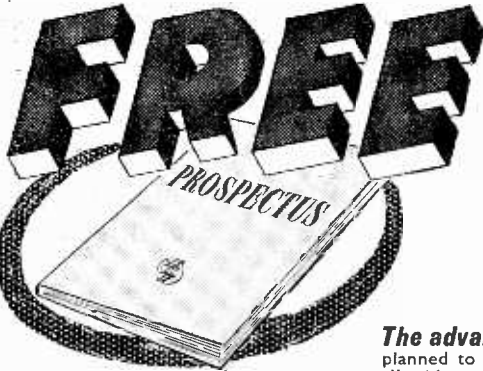

**POST THE COUPON TODAY FOR OUR BROCHURE ON THE LATEST METHODS OF HOME TRAINING FOR OVER 150 CAREERS & HOBBIES**

**PRIVATE AND INDIVIDUAL TUITION IN YOUR OWN HOME**  
City and Guilds Grouped Certificates in Telecommunications: A.M. Brit. I.R.E. Examination, Radio Amateur's Licence, Radio and Television Servicing Certificates, General Radio and Television Courses, Radar, Sound Recording, etc. Also Courses in all other branches of Engineering and Commerce.

**The advantages of E.M.I. training** ★ The teaching methods are planned to meet modern industrial requirements. ★ We offer training in all subjects which provide lucrative jobs or interesting hobbies. ★ A tutor is personally allotted by name to ensure private and individual tuition. ★ Free advice covering all aspects of training is given to students before and after enrolling with us.

**NEW LEARN THE PRACTICAL WAY**  
With many of our courses we supply actual equipment. Courses include: Radio, Television, Electronics, Draughtsmanship, Carpentry, Photography, and Commercial Art, etc.

**Courses from 15/- per month**

**POST THIS COUPON TODAY**  
Send without obligation your FREE book. E.M.I. INSTITUTES, Dept. 32K  
43 Grove Park Road, London, W.4.  
Phone: Chiswick 4417/8.  
NAME \_\_\_\_\_  
ADDRESS \_\_\_\_\_  
AUG. \_\_\_\_\_  
SUBJECT(S) OF INTEREST \_\_\_\_\_

# EMI INSTITUTES

The only Postal College which is part of a world-wide Industrial Organisation

## EXPAND AND

**Laboratory Balanced.** The TSL LORENZ LP312-2 is a main bass 12in. diaxial speaker combined with two LPH65 electro-magnetic high frequency TREBLE units permanently mounted coaxially across the front of the main bass speaker at such an angle to give full spherical binaural response. All are laboratory balanced and matched for perfect tone with a frequency range of 20 cycles to 22,500 cycles essentially level output. To ensure level frequency response the voice coils of the two treble speakers are fed through a specially designed crossover network which balances the frequency response of the three speakers as a combined unit.

## IMPROVE ANY

The TSL LORENZ LPH65 is the basic treble speaker used in the TSL LORENZ Sound System. Round in shape to ensure smooth melodious sound the plastic cone is fully tropicalised. Special features are the super high flux density magnet of 17,500 gauss and non-perforated back plate.

## SOUND SYSTEM

### SPECIFICATION LP312-2

IMPEDANCE 15 ohms; FREQUENCY RANGE 20-22,500 c/s; POWER RATING 25 w.; PEAK POWER RATING 40 w.; DIAMETER Bass 12½ inches Treble 2½ inches; DEPTH Bass 7½ inches Treble 2 inches; BAFFLE OPENING 10½ inches; SPEECH COIL DIAMETER Bass 1.5 inches Treble ½ inch; FUNDAMENTAL RESONANCE Bass 20 c/s Treble 1,600 c/s; FLUX DENSITY Bass 17,500 gauss Treble 17,500 gauss; INTERMODULATION PRODUCTS under 0.5%; CROSSOVER FREQUENCY 2,000 c/s; FINISH, Grey and blue vitreous anti-corrosion stove enamel. RETAIL PRICE, £14.19.6. (Not subject to Purchase Tax.)

Exclusively distributed to the Radio Trade & Industry throughout Great Britain and the Commonwealth by:—

**TECHNICAL SUPPLIERS LTD., HUDSON HOUSE, 63, GOLDHAWK RD., LONDON, W.12. Tel: SHE 2581, 4794**

## JASON FOR F.M.

An easy-to-build Tuner using four valves Type Z77/EF91. Providing leads are kept short and soldered joints are well made, good results are guaranteed. The useful range is at least 60 miles from the station. The Book also gives details of a Fringe Area version which has an aerial sensitivity of 5 micro-volts for good limiting. Book (Data Publications), price 2.-. All components (less valves), **£5.5.0.**

For the more experienced, the Medium Wave and F.M. Tuner is available. This may be built either as a tuner or receiver. The Assembly is supplied with the centre holes blocked by easily removable plastic discs. F.M. sensitivity is 15 micro-volts. Components (less valves) to build Receiver, **£11.10.0.** Tuner, **£10.10.0.**

Available from our usual stockists.

S.A.E., please, for Component Price Lists.

**THE JASON MOTOR & ELECTRONIC CO.**

328, Cricklewood Lane, London, N.W.2. SPE 7050.

## SUPER HIGH FIDELITY THIS YEAR

Let your ears be your judge... crisp, clear, natural reproduction without coloration with TSL LORENZ speaker units. Ten years ahead in engineering and design this speaker unit will enable you to design and build up a sound system in your own home which will truly add the miracle of LIFE to the magic of music...

**No Extra Cost.** You get these extra features at no extra cost with every TSL LORENZ Sound system... Greater output and more sensitivity... heavy duty oversize speech coil... Super high flux magnet... Permanently flexible self-damped cone... Multi-parameter cone fully tropicalised... Sealed in air gaps... built-in centralising device for perfect gap alignment.

**Improve your own H.F. Sound System.** For these devotees of high fidelity who possess bass speakers fitting one or more LPH65 treble units will greatly extend your range of super fidelity reproduction. They are, without a doubt, the most sensitive and efficient treble reproducers research has revealed to date. The non-perforated back plate ensures that the LPH65 can be used with any other speakers irrespective of make or type without interaction taking place.

### SPECIFICATION LPH65

#### HIGH FREQUENCY CONE-HORN TYPE TREBLE UNIT

IMPEDANCE 5.5 ohms; FREQUENCY RANGE WITH SUITABLE HIGH PASS FILTER CONDENSER 2,000-22,500 c/s; POWER RATING AS A SINGLE UNIT 3 w.; PEAK POWER RATING AS A SINGLE UNIT 5 w.; DIAMETER 2½ inches; DEPTH 2 inches BAFFLE OPENING 2½ inches. PRICE 39/6. (Including Purchase Tax.)



Ask your local retailer for full details, including Bass Reflex enclosures.

## Best Buy at Britain's

**RESISTORS.** Latest miniature insulated Dubilier 1 watt type BTS. Wire ends. Useful values. ONLY 10- for 100 assorted.  
**FIELD TELEPHONES.** Army type D. Mk. 5. Buzzer calling. Ideal for building sites, farms, workshops, etc. Complete with handset and batteries. Tested before despatch. 39/6 each.  
**MULTI-RANGE RESISTANCE CAPACITY BRIDGES GM-41401** 1 ohm to 10 Megohms and 10pFd to 10 mFd. For 110 and 230 v. A.C. mains. Used, but in perfect working order. £5.19.6.

**COMMAND RECEIVERS.** Complete with 6 metal valves, 3 12SK7, 1 12K6, 1 12SR7 and 1 12A6. Size 5in. x 5½in. x 11½in. deep. In very good condition. Less dynamotor. FREE CUT-OUT WITH EACH SET.  
BC455, 6-9 Mc/s, 25/-; BC453 (the famous Q5'er), 190-550 Kc/s, 59/6; BC454, 3-6 Mc/s, 27/6; BCXXX ("Trawler" band), 1.5-3 Mc/s, 65/-.

**RECEIVERS TYPE R1155.**—In excellent condition, thoroughly checked and air-tested. These first-class communications receivers are available from £5.19.6, according to condition. Send S.A.E. for particulars or 1/3 for comprehensive booklet.

**A.C. MAINS POWER PACK & OUTPUT STAGE.**—These enable the R1155 to be used on the mains WITHOUT ANY MODIFICATION. Three types available, £4.10.0, £5.5.0 and de-luxe model with 8in. speaker, £6.10.0. Carriage 5-. All Power Packs guaranteed six months.

**DUAL VOLTAGE BLOWERS.**—12 and 21 v. Ideal for hair driers, car heaters, etc., 25/- plus 2/6 postage.

**INSTANT TRANSFORMERS, Parmeko.**—230 v. A.C. input, 0-65-130-195 v. 85 mA, 6.3 v. 5 Amp, 6.3 v. 3 Amp output. Shrouded. 3½in. x 3½in. x 3½in. high. 15/-.

**HEAVY DUTY I.T. TRANSFORMERS.**—200-250 v. A.C. input, 30 v. tapped at 10 v. 36 Amps output, 5½in. x 6in. x 7in. high. wt. 24 lbs., 55/-.

**MINIATURE MODEL MOTORS.**—2in. long x 1½in. diam., 3 16in. diam. spindle, weight 5 ozs. Will work from 6-volt dry battery and are reversible. Ball bearings. Price 8/6.

**METER RECTIFIERS.**—1 mA. Salford Instruments 8/6, 2 mA. S.T.C. as used in E.M.I. Output Meter, 5/6. All full wave bridge and brand new.

**METAL RECTIFIERS.**—250 volts, 100 mA, 6/9 each. 230 volts, 60 mA, 5/- each.

## CHARLES BRISTON (RADIO) LTD.

11, Upper Saint Martin's Lane, London, W.C.2.

Temple Bar 0545

Shop hours 9-6 p.m. (9-1 p.m. Thursday) . Open All Day Saturday

factory. Ignore the marked voltages—the load will not be great—and connect the mains to the middle value. This will enable you to take voltages above and below the mains from the other two. The set-up is as in Fig. 7. Connect to the upper voltage, and measure the total volts and the volts across each of your now adjusted primaries. Repeat for the lower voltage. It will be found that the larger part of the swing is taken up across the choke. The procedure is now as follows: divide the choke swing by the transformer swing, and call the answer *R*. Take either one of the choke voltages—it doesn't matter

their voltages *subtract*. The measured output should now be reasonably close to the calculated value. Unless you have hit upon a most unusual combination of luck and accurate workmanship, it will not be exact; however, a constant 237 volts is much preferable to a nominal 240 volts which may vary from 246 volts in the small hours to 232 volts at Sunday lunch-time!

**Suitable Materials**

Some notes on materials. The performance of a C.V. transformer is very largely dependent upon the quality of the cores. Therefore use the best laminations available. Grades such as Super Silcor, Silcor 1 or their equivalents are excellent. In the size dealt with above, which will support 50 to 80 watts, depending upon the quality of steel and the care with which the apparatus has been constructed, you will require 8 lbs. of laminations in all. It is not necessary to purchase them new, as many of the transformers available on the surplus market are equipped with good "lams." Most of the better quality core-stampings nowadays are colour-coded, being coated on one side with an insulating paint of a distinctive tint. While I cannot claim to know the intentions of all the manufacturers in this respect, I have found that pale green, light red and buff are usually indicative of a high grade. Do not use laminations from a transformer which shows signs of having been overheated.

The wire sizes used are in excess of what is strictly necessary for the currents concerned; however, a constant voltage transformer runs hot, and any measure which will reduce this tendency is to be welcomed. In this connection, a recent publication of the American Institute of Electrical Engineers states that all the materials normally used in the construction of small transformers may safely be run at temperatures up to 90 deg. C. (A.I.E.E. class "O" includes unimpregnated cotton, silk, paper, etc., and all normal grades of wire-finishing enamel but excludes, of course, all waxes and synthetics which have a lower melting-point.) So don't wax-impregnate your C.V.T., and don't worry if it reaches 70 to 80 deg. C. If you wish to apply extra cooling, probably the best method is to incorporate cooling fins with the core. Cut these from thin aluminium strip as shown in Fig. 8 and use three to each core, one at each end between core and clamp, and one in the middle. If you intend to use fins, they must be in place when the gap-adjustment is being done. They also permit the use of iron or steel end-clamps on

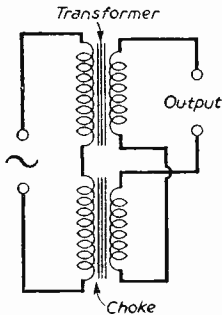

Fig. 5. — Modified version.

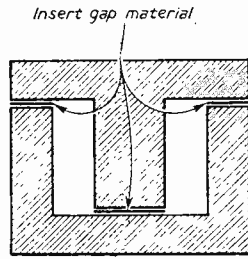

Fig. 6. — Modified choke construction details.

which, they will both give the same answer—and divide it by *R*. Subtract this answer from the corresponding transformer voltage, and label the result *E*. Divide the *required output voltage* by *E*, and the answer is *r.1*, the turns ratio for the transformer. Divide *r.1* by *R* and you have *r.2*, the turns ratio for the choke. Our example will make this clear. You may find the tabular form convenient to work with.

Input Volts	...	220	260	Swing
Transformer Volts...		156	164	8
Choke Volts	...	64	96	32

$R = 32/8 = 4$   
 $64/R = 64/4 = 16$   
 $E = 156 - 16 = 140$   
 Required output = 240 volts.  
 $\therefore r.1 = 240/140 = 12/7$   
 and  $r.2 = 12/7 \div 4 = 3/7$ .

Here we have the two turns ratios, giving the transformer secondary as  $480 \times 12/7$ , i.e., 823 turns, and the choke secondary as  $480 \times 3/7$ , i.e., 206 turns. The two primaries are now dis-assembled from their cores, the choke gap-pieces being most carefully preserved, and the appropriate secondaries wound on, using the same gauge of wire as the primaries. Slight readjustment of the gap may be found necessary on reassembly, in order to regain the correct primary voltages. This can often be accomplished by means of taps with a wooden-headed mallet. Now connect the secondaries in series opposition, that is, so that

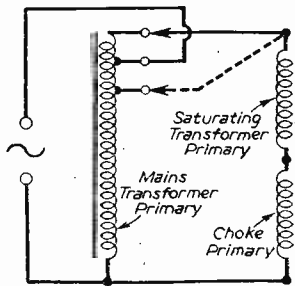

Fig. 7. — The arrangement to measure performance on varying voltage.

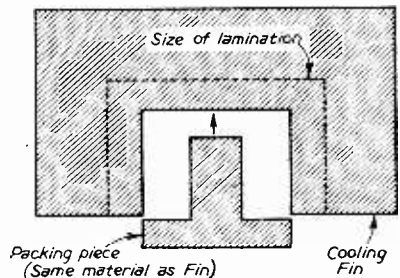

Fig. 8. — Method of fixing cooling fins.

the choke, since they prevent the clamps from shorting the gap. The finished apparatus may be mounted on a board and provided with a cover of perforated metal. It should not be closely boxed in, since adequate ventilation is essential.

Finally, a word on the limitations. The apparatus described can be built for a fraction of the cost of a commercial 50-watt C.V.T.; its performance falls short of best commercial practice in the following respects. The output waveform is not sinusoidal;

since a constant peak voltage is maintained, this is of no importance where the application is to a rectifier power pack, but it means that the effective regulation of heater voltages derived from the apparatus is not quite so good as meter readings indicate. Again, the load regulation characteristic is not so good as could be desired (a defect all too common in factory-built models as well), which means that it is inadvisable to effect considerable variations in the load during the course of a single experiment or test.

#### Summary of Steps.

1. Ascertain nominal mains supply voltage.
2. Decide on core area,  $a$ , taking say 40 watts output per square inch.
3. Work out turns per volt, using formula  $t.p.v. = 70/a.B.$ , taking  $B$  as 16.
4. Primary turns =  $t.p.v. \times 2/3$  nominal mains supply voltage. Each component will

have the same primary turns.

5. Wind primaries, assemble on cores.
6. Adjust gap for correct voltages.
7. Calculate secondaries as above, wind and reassemble.
8. Test, and make final readjustments of choke gap. (On load, if necessary.)

## Electronic Aircraft Trainer

THE pace of modern aerial warfare demands that interceptor fighters be directed with the utmost speed and accuracy to approaching enemy aircraft. In turn this means that the controller guiding the fighters must be well versed in the art of ground-controlled interception.

To train controllers to the necessary high standard of proficiency requires constant practice, a requirement difficult to achieve without the considerable expense incurred in flying aircraft especially to provide echoes on the radar screen. To save this expense, amounting to many hundreds of pounds per hour, and to make training independent of flying conditions and the weather, a radar simulator capable of producing artificially the tracks of up to 12 aircraft on a radar screen has been designed. Each aircraft track is capable of individual control of speed and direction so that the echo produced on the screen behaves exactly as a real echo.

Each artificial "aircraft" is controlled from a pilot's unit having controls for speed of flight and rate of turn. Indicators on the pilot's unit show heading (direction of flight) and (for ease of operation and setting up) "eastings," "northings," and the range of the "aircraft" from the radar station. It is also possible to introduce the effect produced by wind on the aircraft; the simulated "wind" is controllable in speed and direction.

The radar trainer may be used in conjunction with a radar station so that live and simulated aircraft may be shown together on the radar screens. This adds even more to the realism of the exercises which may be carried out with this equipment. It also enables the station controllers to be kept proficient as practice exercises may be run at any desired time.

#### Advantages of the Trainer

By dispensing with the need for flying aircraft and operating actual radar equipment, the cost of training a controller is reduced enormously. It is estimated that the savings are such that the cost of a trainer equipment can be recovered in a week. In addition, training is now independent of weather conditions.

The radar trainer has been developed by Mullard,

Ltd., in conjunction with the Ministry of Supply, for the Royal Air Force for training ground control (interception) controllers. It is now being made available as a commercial equipment, and will be invaluable to overseas air forces for the same type of work. In addition, it is of interest to large civil airports, both for training and for the experimental investigation of aircraft handling systems.

#### Performance

Accuracy, reliability and adaptability are essential in this kind of equipment.

The Mullard radar trainer simulates aircraft speeds, rates of turn and positions with great accuracy. Thus, a trainee controller will get the feel of handling actual aircraft, and will experience no difficulty when he changes over to a real radar system.

Reliability is ensured by careful construction to stringent specifications. Care in layout and mechanical design makes servicing a simple matter.

In the design of this equipment the Mullard SL.21 (R.A.F. type 2292) allowance has been made both for improvements in aircraft performance and variations in radar equipment. The top aircraft speed is 1,000 knots, and rates of turn up to rate 3 (90 deg. in 10 seconds) are available. Winds up to 100 knots in any direction can be simulated. The maximum range simulated by the equipment is 200 nautical miles.

The trainer can be used in conjunction with a wide variety of radar displays of the PPI (plan position indicator) type. The actual indicator units of existing radar systems may be used for displaying the artificial tracks, so that trainee controllers get used to working on operational equipment. When used alone aerial rotation can be produced artificially in the equipment.

The physical appearance of tracks on the screen of real radar systems is liable to vary from one radar equipment to another, dependent on such factors as aerial beamwidth, pulse length and aerial rotation speeds. Allowance has been made for this and artificial echoes can be adjusted to match those produced by any radar system.

### WIRELESS COILS, CHOKES AND TRANSFORMERS

8th Edition.

Price 6/-, by post 6/4.



# RADIO & R/GRAM CHASSIS 39/6

3 w/band and gram. Extra speaker sockets. 5 valve Int. Octal Built-in portable aerial (optional). 4 knob control, A.C. or Universal. Less valves. See our cheap list. 8in. P.M. speaker, 7/9 with order. Set of knobs, 2/- Chassis 15 1/2in. x 7in. x 9in. (when speaker is fitted. Carr. 4/6.

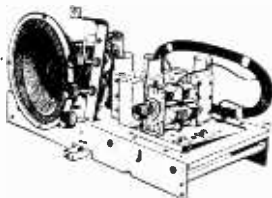

## MIDGET RADIO CHASSIS. 79/6. 8 het.

International octal valves. 5 valve Universal 110-250 volt mains. Including speaker and dial. Tested guaranteed. Less valves. Chassis size 13 1/2in. x 9 1/2in. x 7in. Carr. 3/6.

**RADIO-GRAM CHASSIS. 29/9.** Complete with 8in. speaker. 5het. 5 valve A.C. 3 w/band. Front drive. Complete less valves. Tested guaranteed. Chassis size 12in. x 10in. x 8in. Carr. 4/6.

**COIL PACKS. 3/9.** 3 band, including pair 465 I.F.S. 2-gang cond. and dial (similar drawing) free. Post 2/3.

## T.V. CHASSIS UNITS

**TIME BASE. 10/6.** Containing scanning coil, focus unit, line trans., etc. FREE drawing. Carr. 3/6.

**SOUND & VISION STRIP. 27/6.** 8 het. complete s/vision strip, 10 valve holders (EF91, etc.). Less valves. FREE drawing. Post 2/6.

**POWER PACK & AMPLIFIER. 29/6.** Mains E.H.T. 5 kV., 325 v., 250 m.a. Smoothed H.T. Heaters, 6 v. at 5 amp., 4 v. at 5 amp., 4 v. at 5 amp. Extra winding for 2 or 4 v. tubes. FREE drawing. Carr. 5/6.

**P. PACK & AMP. 22/6.** Output stage 6V6 with O.P. trans. 3 ohms matching. Choke. Smoothed H.T. 350 v., 250 ma., 6.3 v. at 5 amp., 22 v. at 3 amp., 6.3 v. at 4 amp., and 4 v. centre tapped. Less valves. Ins., carr. 5/6.

**P. PACK & AMP. 22/6.** Output stage 6V6 with O.P. trans. Choke. Smoothed H.T. 325 v. at 250 m.a., 4 v. at 5 amp., 6.3 v. at 5 amp., 4 v. at 5 amp. Centre tapped. Less valves. Ins., carr. 5/6. Remember SATURDAY open all day.

MONEY BACK GUARANTEE **DUKE** **CO** CWO COD

621 ROMFORD RD. LONDON. E.12.

6677

**IT'S NEW!**

**BUILD THIS FRYING-PAN RADIO FOR**

**ONLY 79/6 POST FREE**

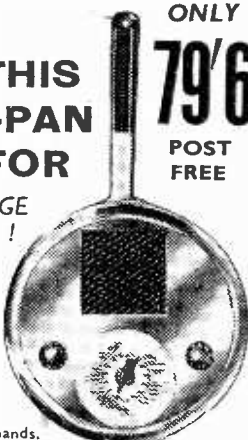

**NO RADIO KNOWLEDGE WHATEVER NEEDED!**

Can be built by anyone in an evening using our step-by-step, easy-to-follow plans. Total building cost including mirror finish frying-pan and everything down to the last nut and bolt only 79/6. Post Free. It is a **REAL ALL-ELECTRIC RADIO** with normal size speaker, etc. Exceptionally sensitive circuit covering all Medium and Long Wavebands. RECEIVES "HOME," "LIGHT," "LUXEMBOURG," "A.F.N.," Etc., Etc., really beautiful tone due to "wall-baffle" effect. Size only 9in. Diameter, 2in. Deep, and handle 7in. Long. Hangs anywhere—**IDEAL FOR KITCHEN, BEDROOM, ETC.** (Mains lead passes unnoticed through the hollow handle.) **AMPLE VOLUME. RUNNING COSTS ONLY 1d. FOR 75 HOURS!** Weight only 3 1/2 lbs. For A.C. Mains 200 to 250 Volts. Robust design and should last a lifetime. **EACH PART TESTED BEFORE DESPATCH, AND YOU CAN'T FAIL BECAUSE OUR EASY-TO-FOLLOW PLANS TAKE YOU STEP-BY-STEP. BUILD ONE OF THESE AMAZING LOW-PRICED SETS—NOW!** Total building cost including full set of plans 79/6 Post Free. (Parts may be bought separately, Parts Lists 2/6.) **LIMITED QUANTITY. Send Cheque or Postal Order Today! Please cross Postal Orders.** (C.O.D. 2/- extra.)

**Eastbourne Radio Co.** (Dept. PW2) 30, OCKLYNGE RD., EASTBOURNE, SUSSEX



I.C.S. training supplies the spark you need to further your career. The Courses I.C.S. offer are practical and up-to-date, they recognise the present emphasis on Frequency Modulation, and can help you attain one of the many well-paid posts that exist today in the radio world. Prepare yourself now, at home and in your own time, with the expert help of I.C.S. tutors. The cost of an I.C.S. Course is moderate and includes all books.

Among the I.C.S. Courses available are:

- FREQUENCY MODULATION ENGINEERING
- T/V ENGINEERING
- RADIO SERVICING
- RADIO ENGINEERING
- RADAR ENGINEERING
- BASIC ELECTRONICS
- INDUSTRIAL ELECTRONICS
- ELECTRONIC ENGINEERING

Complete the coupon below and post it to us today for further details of the Course which interests you. Write to: Dept. 170E, I.C.S., 71 Kingsway, W.C.2.

**REDUCED TERMS FOR H.M. FORCES**

INTERNATIONAL CORRESPONDENCE SCHOOLS  
DEPT. 170E, INTERNATIONAL BUILDINGS, KINGSWAY, LONDON, W.C.2.

Please send FREE book on .....

NAME..... AGE.....  
(Block letters please)

ADDRESS .....

OCCUPATION .....

**INTERNATIONAL CORRESPONDENCE SCHOOLS**

# ADCOLA

PRODUCTS LIMITED  
(Regd. Trade Mark)

## SOLDERING INSTRUMENTS AND EQUIPMENT

*Sound jointing for the  
Home Radio Engineer*



Detachable Bit  
Model  
(List No. 64)  
Bit sizes  $\frac{3}{8}$ " to  $\frac{1}{4}$ ".

Supplied for all  
volt ranges with no  
extra cost for low  
voltages.

Apply Catalogues :

Sole Proprietors & Manufacturers

HEAD OFFICE SALES AND SERVICE

**ADCOLA PRODUCTS LTD.**

GAUDEN ROAD., CLAPHAM HIGH ST.,  
LONDON. S.W.4. Tel.: MACaulay 3101-4272.

## ASPDEN TAPE DECKS

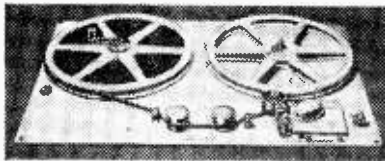

Two speed Twin Track.

Compact Deck, Model 521, 7 $\frac{1}{2}$ in. x 11in. 5in. reels.  
KIT, £7.10.0.

Standard Deck, Model 721, 10 $\frac{1}{2}$ in. x 15in. 7in. reels.  
KIT, £8.10.0.

Precision machined parts, easy to assemble with  
full assembly instructions and drawings. High  
Quality Ferroxcube Heads. Finest motor.

Either deck fully built and tested, 27/6 extra.

"It is a very fine piece of work for quality and  
appearance."—D. E., Notts.

NEW AMPLIFIER KIT

Record/replay—2 $\frac{1}{2}$  watts output—Neon Level  
indicator—2 recording positions.

Kit without valves, £5.18.0.

Power Pack Kit for above, without valve, £2.18.6.  
Carriage extra.

Send stamp for full details to :

**W. S. ASPDEN** 10, Market St., Wesham  
KIRKHAM, LANCs

## A REALLY SELECTIVE 5-VALVE SUPERHET



**139/6**

Plus 2/8 for  
Postage &  
Packing

Our "know-how" shows you the  
easy way to surprise friends with this  
Superb Superhet.  
**NO RADIO KNOWLEDGE NECESSARY.**  
Easy to read step-by-step instructions  
and Diagrams. We guarantee it to  
work. Only tools needed are Pliers,  
Screwdriver and Soldering Iron.

**IDEAL FOR BEGINNERS . . . A TRF.**

. . . Let us show you how simple a 3 Valve TRF Receiver  
can be to make our way and how amazed you will  
be. Easy-to-Follow instructions take the headaches out  
of construction. Hundreds already working all over  
the country. 109/6, plus 2/8 post and packing.

**A PROFESSIONAL JOB MADE SIMPLE**

Nothing to lose—Our MONEY-BACK guarantee covers  
you. Complete parts available for the above receivers  
in Cream or Brown cabinets. . . . Write to-day and  
get started on the fascinating Hobby of Electronics.

EASY INSTRUCTIONS WITH OUR "KNOW-HOW"  
DIAGRAMS, 1/- POST FREE. SEND TO-DAY.

**NORMAN H. FIELD Electronics**  
Dept. PW, 68, HURST STREET, BIRMINGHAM, 5  
Birmingham's Largest Constructors

## HANNEY of BATH offers:—

**VIEWMASTER 3-STATION TV TUNER** (P. Television).—  
Denco coilset with screens, can and screws, 30/-; Denco switch,  
Fine Tuner, Coil mounting plates and tag panel, 27/-; Kit of resis-  
tors, 7/6; TCC condensers kit with 2 printed circuits, valveholders,  
etc., 43/-; Gain controls, 3/3 each; Co-ax P/Skit, 2/6; Valve  
cans, 1/3 each. Complete kit of parts for the TUNER, with the 2  
Genuine MULLARD Valves, nuts, bolts, wire co-ax., etc., £3/19/6.  
Denco Coilset for conversion of the V-Master S/V chassis to the  
I.F. amplifier, 20/-, OR Complete kit of S/V conversion com-  
ponents, 39/6. All Standard V-Master items in stock. Full list  
available.

**MULLARD 3-VALVES 3-WATT AMPLIFIER**.—Punched  
chassis, 10/6; Gilson Trans., Mains, 35/-; Output, 25/6; Elstone  
Trans., Mains, 35/-; Output, 21/-; Condenser kit, 20/-; Resistor  
kit with 3 pots, 22/6. Complete kit with Genuine MULLARD VALVES  
£8/19/6. Full list available.

**MULLARD 510 AMPLIFIER**.—Erie Resistors, 27/-; TCC  
Condensers, 45/-; Elstone Mains Trans., 36/- (100 m.a.); 42/6  
(120 m.a.); Output Trans., 45/- (6K, or 8K.); Gilson mains trans.,  
60/- (140 m.a.); Output trans., 47/6 (6K, or 8K.); Ultra linear  
type, 52/6; Partridge Mains trans., 65/6; Output trans., P.3667,  
55/6; Partridge Ultra Linear type P.404, 98/6; Denco punched  
chassis, 19/6, with base plate; Printed front panel, 6/6; Type  
"A" and "B" Chassis (panel not printed), 8/6 and 12/6 respec-  
tively; condensers, "A", 15/6; "B", 24/6; Resistors, "A",  
17/6; "B", 35/6 (with pots.). Full list available, giving details of  
complete kits.

**OSRAM 919 PLUS AMPLIFIER**.—Erie resistor kit, 17/4;  
Erie 1 meg. pots, 4/6 each; TCC condenser kit, 55/-; PART-  
RIDGE components with loose lead terminations (includes packing  
charge), Mains trans., 65/6; choke, 34/6; output trans., 85/6;  
W.B. components, Choke, 18/9; output trans., 32/-; Denco  
drilled chassis, 14/6; Denco 912 Plus printed panel, 7/6; pre-  
amp or passive chassis, 6/-. Full list available.

**COMPONENTS** are still available for the following **F.M. TUNERS**:  
Wireless World, Mullard, Osram 912, Denco Maxi-Q. List available.  
**WIDE ANGLE COMPONENTS**. ALLEN Teaking Chassis,  
50/-; Coilsets (TK and Super-Visor), 44/6; LO.338, 40/-; PO.305,  
21/-; DC.300c., 39/6; FC302, 31/-; GL.16 and 13, 7/6 each;  
SC.312, 21/-; AT.310, 30/-; OP.117, 9/-; BT.314, 15/-; Denco  
Chassis Magnaview, 37/6; Chassis, Super-Visor, 51/6; Coil sets  
Magnaview, 41/2; WA/DCAI, 43/-; WA/FCAI, 31/-; WA/LCI  
and WCI, 7/6 each; WA/FMAL, 21/-; WA/LOTI, 42/-; WA/FBTI,  
16/-.

Send stamp for lists. Please add 2/- postage to all orders under  
£3 (excess refunded).

**L. F. HANNEY**  
77, LOWER BRISTOL ROAD, BATH  
Tel.: 3811

# Using TEST INSTRUMENTS



The Final Article in a Series  
Dealing with the Practical Application  
of Standard Test Equipment



(Concluded from page 316 July issue)

**T**O ensure that the method of frequency calculation is accurate, the adjustable shorting bar should be as slim as possible so that there is very small error when measuring the distance between the two points of contact on the Lecher wires. It is also important to make sure that the shorting bar is placed at right-angles across the parallel wires.

Having calibrated our grid-dip oscillator by one of the methods outlined last month, we are in possession of an extremely useful and versatile piece of test equipment. Simply by bringing the instrument's oscillator or pick-up coil in proximity to any representation of an external tuned circuit and adjusting the tuning control the resonant frequency of the external circuit, as indicated by a fall in grid current, can quickly be read from a calibrated dial or graph.

## Checking Tuned Circuits (63)

It will readily be appreciated that such a feature has great possibilities, to the experimenter and service engineer alike, in aiding in the determination of the resonant frequency of, say, an oscillator, aerial or R.F. coil of a TV or V.H.F. receiver. It can also be used, of course, as a means of assessing the frequency of I.F. transformers or band-pass coils. With TV the grid-dip oscillator is particularly useful to help with the modification of coils when it is desired to alter the acceptance channel of the set.

The same reasoning applies to the design of coils used in V.H.F. and Band III tuner units. A frequency check of the overall circuit becomes possible, that is when the coil is actually wired in circuit to the valves and associated components. It is well known that with V.H.F. equipment the frequency at which the coils are resonant is governed to a large degree by the stray shunt capacitances of the associated wiring and components, by the relative positions of the components in the circuit and by the input and output capacitances of the valves themselves.

It often happens in practice, even though we may take a good deal of trouble in computing the number of turns required by the coils, using an arbitrary value for the inevitable shunt capacitances, that the computed resonant frequency falls well short of the mark. Not many of us possess accurate equipment for measuring the value of small capacitances.

However, it becomes a relatively simple matter to couple the oscillator or pick-up coil of the instrument to the tuned circuit under examination, while it is actually connected in the circuit, but with the equipment switched off, and then adjust either the coil, by altering the number of turns or turns spacing, or the value of the related fixed tuning capacitor, until the

required resonant frequency is indicated on the instrument's calibrated dial or graph.

With unscreened coils the grid-dip oscillator's oscillator coil is best brought up to the coil under test; the loading should not be too great, the aim should be to secure the smallest readable deflection on the indicator.

With screened coils this procedure cannot, of course, be adopted. Here some other method must be used to couple power from the oscillator to the circuit under test. Capacitive coupling serves quite well, provided the coupling is not too tight. The value of capacitance required will depend on the frequency of the circuit, but sufficient coupling can generally be obtained by winding a turn or so of thin p.v.c. covered wire round the instrument's coil former or round one end of the coil's lead-out wire. The other end of the p.v.c. wire should be soldered to the H.F. side of the coil to be tested (see Fig. 82).

With coupled coils, like band-pass coils and I.F. transformers, it is often a good idea to damp one of the windings with a 5 K resistor while testing the other winding. This avoids interaction between the two coils while endeavouring individually to adjust the coils. Incidentally, if the grid-dip oscillator tunes over the I.F. range of radio and TV sets it is possible, simply by using the instrument as an indicator of resonance, to align the I.F. stages without even switching the set on. It is required to adopt the capacitive method of coupling in most cases. If the tuning range of the instrument is not too cramped a good idea of the response curve of the tuned circuits can be obtained by detuning either side of the resonant

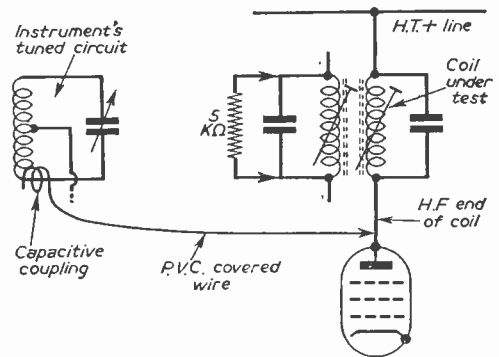

Fig. 82.—Achieving a degree of capacitive coupling by winding a turn or so of p.v.c. covered wire round the instrument's oscillator coil.

frequency and observing the reduction in grid current indication; a frequency versus grid-current graph can be scaled if required. It is important to keep the set switched off while making tests *in situ*, as the emission of the valves tends to have a damping effect on the tuned circuits.

Anything which is likely to have a resonant frequency within the range of the instrument can be checked as described above. Experimenters who are using indoor V.H.F. and TV aerials may or may not be surprised to learn that the plumbing in the vicinity of their loft arrays is resonant at a multiple or sub-multiple of the V.H.F. or TV frequency—perhaps here lies the solution to the problem of adverse reception! Capacitors can be checked for inductance and chokes for capacitance. Using a standard capacity or a standard inductance, it is not a difficult matter to measure inductance or capacity, aided by the expression

$$\text{Frequency at resonance} = 1/2 \pi \sqrt{LC}$$

We can use the grid-dip oscillator to find the frequency at resonance, and if we use a standard we know either L or C, so it is not much trouble to find the unknown.

#### Checking the Frequency of V.H.F. and TV Aerials (64)

The best way of checking the resonant frequency/ies of a TV or V.H.F. aerial is to couple the aerial's feeder to a one-turn coil coupled to the instrument's oscillator coil, as was described last month (see Fig. 83). In this way the aerial can be checked under normal siting conditions. If the aerial is so checked at ground level there is the possibility, owing to unnatural earth effects, that the reading will be somewhat different from that obtained with an aerial properly mounted. Nevertheless, there are times, while building an aerial, for example, when it is quite impossible to make frequency adjustments at roof

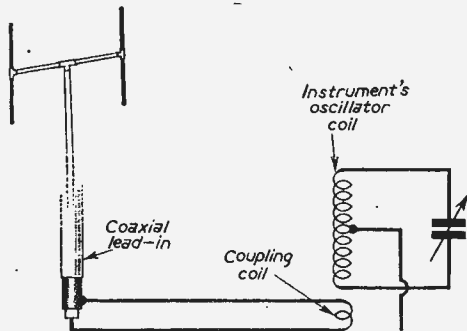

Fig. 83.—Coupling to coaxial cable by means of a small coupling coil.

level. In these cases the aerial should be mounted at working level (off the ground) and as far removed as possible from near-by buildings and large metal objects.

During the course of constructing multi-element arrays it often pays first to adjust the length of the dipole for resonance at the mean frequency between the sound and vision carriers (or towards the vision frequency if a greater vision signal is required), or for resonance at the centre of Band II in the case of a V.H.F. array. The frequency generally shifts slightly when the parasitic elements are added.

## Big A.A. Radio Expansion

PLANS for a 20 per cent. increase in its radio network in 1956 were announced recently by the Automobile Association.

By the middle of this year the A.A.'s radio "umbrella" will cover more than 36,000 square miles of the British Isles. A total of 27 transmitters controlled from 22 A.A. offices will enable radio contact to be maintained with 300 patrols.

Five new radio control centres are to be established—at Belfast, Brighton, Dublin, Leicester and St. Helier, Jersey—adding a total of 6,000 square miles to the area covered by the existing radio-controlled break-



down service. The installations at Belfast and Dublin will bring radio-assisted motoring to Ireland.

In addition, a second "Jumbo" Mobile Radio Office, complete with 60ft. radio mast, will be available for use in emergency and at special events, and the number of walkie-talkies and transportable sets now in use is to be greatly increased.

The use of radio by the A.A. has progressed rapidly since a small pilot scheme was launched in London in 1949 with two breakdown vehicles controlled by a small transmitter on the roof of Fanum House. It soon proved to be of inestimable value in speeding up service to members.

**DIRECT FROM THE MANUFACTURER**

MODEL H4.

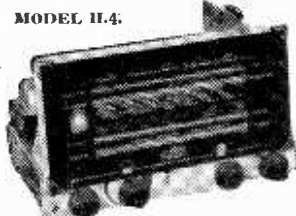

**AM/FM  
H. 4  
RADIO AND  
RADIOGRAM  
CHASSIS**

The H4 chassis offers the finest value to the customer. Designed for first rate reproduction of radio and gramophone. Wide range tone control and an output transformer of liberal capacity is fitted. HQ inductances. Separate ferites for medium and long waves. Adjustable iron dust cores. Oscillator compensated for zero drift and enclosed in die cast case for minimum radiation. 4 wavebands including FM. Latest miniature tuning indicator output impedances 3 or 15 OHMS. **Model F.3. 3 Wavebands, 5 Valves, 4 watt output, wide range tone control. £14. 11. 11** (tax) **Model F.3.P.P. 3 Wavebands, 7 Valves, 6 watt output, with "Push Pull" stage. Separate Bass and Treble controls. £18. 15. 4** (tax)

**ALL GOODS FULLY GUARANTEED**

ALL ABOVE CHASSIS ARE ASSEMBLED AND READY FOR USE AND BUILT TO HIGHEST TECHNICAL STANDARDS. Write also for details of Tape Recorders and Crystal Receiver Tuners.

We have designed an approved PRE-AMPLIFIER for the New COLLARO Tape Transcriber.



**COMPANY LTD.**

97 VILLIERS ROAD LONDON · N.W.2  
Telephone: Willesden 6678.

**Radio Amateurs and Engineers**

send 6d. for a copy of our latest list of components, etc., for the Home ENGINEERS.—8uf 450 v. 2/3, 16uf 450 v. 3/-. 32-32uf 350 v. 5/6, 25uf 25 v. 1/9, 50 uf 50 v. 2/-.  
TV Types: 100uf 450 v. 5/-. 100-200 uf 275 v. 7/6, 84-120 uf 275 v. 7/6, 60-250 uf 275 v. 8/6, 32-100 uf 450 v. 15/-. 200-200-200 uf 275 v. 12/6 each.  
METAL RECTIFIERS.—RM1 4/-. RM2 5/-. RM4 20/-. 14A86 21/-. 14A97 25/-. 14A100 27/6. 14A124 30/2. 14B130 35/10.  
Band III Converters, Band III aerials, Taylor Meters, Tools, Valves Bases, etc., also Norman Price and Bernard Publications, T.S.L., Speakers and P.M. Tuner Components.

**RADIO HAM SHACK LIMITED**

155, SWAN ARCADE, BRADFORD 1, YORKS

**WHY WASTE TIME**

Give that set its best chance  
**FIT QUALITY COMPONENTS**

Catalogue 1/-. Manual

Parts for the following:	Manual
Osram "912" Plus Amplifier ... ..	4/-
Mullard 10-watt Amplifier ... ..	3/6
The Coventry	
2-watt Amplifier ... ..	} 1/-
4-watt Amplifier ... ..	
6-watt Quality Amplifier ... ..	
The Coventry A.M. Tuner Unit ... ..	1/-
Denco F.M. Tuner Unit ... ..	1/6

Complete Component Price Lists will be supplied with each Manual

**COVENTRY RADIO**

EST. 1925  
189, DUNSTABLE ROAD, LUTON, BEDS.  
Phone: Luton 2677



**JUNIOR  
UNIVERSAL  
METER**

*Model 120A*

A small 19-range instrument ideal for the enthusiastic amateur. Sensitivity is 1,000 o.p.v. A.C. and D.C. Accuracy: 2% D.C.; 3% A.C.

**RANGES**

Volts D.C.: 0-25-10-50-250-500-1,000-2,500.  
Volts A.C.: 0-10-50-250-500-1,000-2,500.  
Milliamps D.C.: 0-1-10-50-500-5,000.  
Resistance: 0-2,000 ohms, 0-200,000 ohms. Can be extended to 20 megohms. Automatic overload protection fitted to meter movement.

**PRICE £9.15.0. PROMPT DELIVERY**

CREDIT TERMS: Nine monthly payments of £1.4.4.

**TAYLOR ELECTRICAL INSTRUMENTS LTD.**

Montrose Avenue, Slough, Bucks.  
Telephone: Slough 21381. Cables: Taylins, Slough

**COMMUNICATIONS RECEIVER R.1155.**—The famous Bomber Command Set. Covers 18.5-7.5 Mc/s, 7.5-3.0 Mc/s, 1,500-500 kc/s, 500-200 kc/s, 200-75 kc/s. BRAND NEW. ONLY £11.19.6. ALL tested working before despatch, and supplied with 14-page booklet which gives technical information, circuits, etc. (available separately 1/3).

**A.C. MAINS POWER PACK OUTPUT STAGE.** In black metal case. Enables receiver to be operated immediately by just plugging in. Supplied WITH built-in speaker £5.5.0. or LESS speaker £4.10.0.

DEDUCT 10/- IF PURCHASING RECEIVER & POWER PACK TOGETHER. Add carriage costs of 10/6 for receiver, 5/- for power pack.

**AMERICAN "COMMAND" RECEIVERS.**—Huge purchase from the Air Ministry. These famous compact receivers which can be used for a variety of purposes are offered at ridiculously low prices while stocks last. Complete with 6 metal type valves, 1 each of 12K8, 12SR7, 12A6, and 3 of 12SJ7, in aluminium case size 11" x 5 1/2" x 5". Used, but in very good condition, although cases may be somewhat dented. Circuits supplied. First come, first served. Choice of models, BC455 (6-9 mcs), 25/-, BC454 (3-6 mcs), 27/6, BC453 (190-550 kcs, the renowned "Q" Fiver), 59/6, and a few of the 1.5-3.0 mcs, model 85/-. (Carriage, etc., 3/-.)

**COLLINS TCS TRANSMITTERS.**—Special offer of these famous American Transmitters. Frequency range 1.5-12.0 mcs in 3 bands. Employs 7 valves, 2 of 1625 in P.A. Stage, 1625 buffer and 1625 modulator Stage, 3 of 12A6 in oscillator stage. Radio telephone or radio telegraph. Provision for VFO or Crystal Control. 4 crystal positions. Has plate and aerial current meters. In BRAND NEW CONDITION. ONLY £12.10.0. Matching receivers available £8.10.0, or THE PAIR £20. (Carriage 10/- each.)

**RECEIVER 25/73.**—Part of the TR.1195, this makes an ideal basis for a mains operated all wave superhet, full modification data being supplied. Complete with valves 2 each EF35 and EF39, and 1 each EK32 and EBC33. BRAND NEW. ONLY 27/6 (post, etc., 3/-).

**TR.1194 TRANSMITTER SECTION.** complete with valves EF50, EL32, CV501, and all components. BRAND NEW. ONLY 12/6 (post, etc., 3/-).

(Amounts given for carriage refer to inland only.)

**U.E.I. CORPORATION** 138, Gray's Inn Road, London, W.C.1 (Phone: TERMINUS 7937)

Open until 1 p.m. Saturdays. We are 2 mins. from High Holborn (Chancery Lane Station), and 5 mins. by bus from King's Cross.

BUILD THIS FOR £5.7.6.!

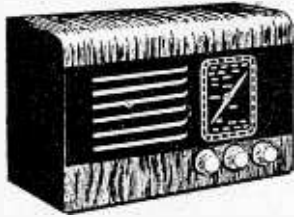

Total building cost including choice of beautiful walnut veneered cabinet or ivory or brown bakelite. This is the lowest possible price consistent with high quality. No radio knowledge whatever needed...

CONDOR ELECTRONICS (Dept. PK8), 39, Queen's Road, Brighton, 1.

THE VALVE SPECIALISTS Bentley Acoustic Corp. Ltd. 38, CHALCOT ROAD, N.W.1. PRImrose 9090

1st grade goods only. No seconds or rejects.

Table listing various vacuum tubes with their types, manufacturers, and prices. Columns include tube type, manufacturer code, and price.

ALFRED PADGETT 40, MEADOW LANE, LEEDS II

Tube Unit BC929A. Complete with 3BP1 6in. tube. Less valves. This is a scope all but made, £1.5.0. Carriage 7.6. (Tube guaranteed.)

All boxed. Full maker's guarantee. Post 6d. each. Insurance (optional) 6d. per order. Shop hours 8.30 to 5.30, Sat. 1 p.m. Write 'no phone or wire that urgent order' for immediate despatch. C.O.D. 1/6 and conditions of sale S.A.E.

INTERNATIONAL TUBE Handbook 15/- Post 9d. (MK BUZEN)

HIGH-FIDELITY The Why and How for Amateurs. By G.A. Briggs. Price 12s. 6d. Postage 6d. GERMANIUM DIODES. By Dr. S. D. Boon. Price 9s. 6d. Postage 6d. ELECTRONIC MUSICAL INSTRUMENTS. By R. H. Dorfl. Price 55s. 0d. Postage 1s. RADIO-CONTROL HANDBOOK. By H. G. McEntee. Price 18s. 0d. Postage 9d. FUNDAMENTALS OF TRANSISTORS. By L. M. Krugman. Price 25s. 0d. Postage 9d. PRACTICAL WIRELESS SERVICE MANUAL. By F. J. Camm. Price 17s. 6d. Postage 9d. THE RADIO AMATEUR'S HANDBOOK. By A. R. R. L. Price 30s. 0d. Postage 1s. 6d. RADIO SERVICING POCKET BOOK. By E. Molloy & J. P. Hawker. Price 10s. 6d. Postage 6d.

The MODERN BOOK CO.

BRITAIN'S LARGEST STOCKISTS of British and American Technical Books 19-23, PRAED ST., LONDON, W.2 Phone: PADdington 4185 Open 6 days 9-6 p.m. 1956 Catalogue Free on Request.

288 yds. SLEEVING! 9/6d.

Great 'Peribaird' sleeving, brand new, 1 mm. bore, 288 yds. on reel, only 9/6 (2/6 postage). Assorted sleeving, 1-2 mm. bore, 4 colours, 30 yds. for 2.6 (post 6d.)

BARGAINS IN TOP QUALITY VALVES! MAKERS' CARTONS - 6K401, 5/9; 6SH7, 4/9; 6BH6, 2/9; 6SK7, 3/9; VU111, 2/9. UNUSED BOXED - 12H6, 1/3; KT263, 5/-; 8J, 6/8; 6Q7/7, 7/6; B134, 1/9; 6J7, 5/9; 8P41, 2/9. PLUGS FOR VALVE HOLDERS - International Octal, 2/3; B74, B9A, 1/8. CLEARANCE UNUSED CARBON RESISTORS. (Famous make) - 1 watt 700 0, 3K, 4K, 5-6K, 20K, 30K, 200K, 8d. (5-10z); 2 watt 30 4, 200 0, 330 0, 3K, 15K, 300K, 500K, 4d. (8/- doz); 1 watt, 20 0, 12K, 15K, 75K, 150K, 180K, 3K. (2/6 doz); 1/2 watt 20 0, 33 0, and 1 watt, 1K, 10K, 2d. each (1/9 doz). (Nearly all the above will accept 100% overload). UNUSED POTENTIOMETERS (with spindle) - 500K, 6K, 1.3 or 6 for 5/8. MIDGET 500r. CERAMIC (Range extended). 2, 3, 4, 7, 7.5, 10, 15, 22, 27, 33, 39, 47, 56, 75, 100 150, 200, 270, 330, 390, 470, 1,000, 2,000, 3,000, 5,000, 8d. each, 7/8 doz. (10,000 pf, 10d. each). ELECTROLYTICS - 45 and 45N (5/9); 5/9; 32+32 mfd, 350 0, 4/3; 32+16 mfd, 330 0, 3/9. LOW LOSS COAX - latest cellular polythene, suitable Band I or III, 9d. yd. COAX FITTINGS - solderless plug, 1/2; socket, 1/3; outlet bus, 4/8; coupler (double socket), 1/6; 1/2 in. connector (permanent joint), 1/3. WIRE WOUND RESISTORS (silicone coated). - 25, 50, 100, 150, 200, 250, 300, 500, 1,000, 1.5K, 2K, 2.5K, 3-5K, 5K, 6-8K, 10K, 5, 10, 13; 10 w, 1/8; 15 w, 1/8; 15K, 18K, 20K, 25K, 50K, 5, w, 1/9; 10 w, 2/3; 47K, 5 w, 2/8; 10 w, 2/8. LATEST 'GEN' BOOKS PRACTICAL TRANSISTORS & TRANSISTOR CIRCUITS. - Build these new circuits now using your own cheaply made transistors, 3/6, post 3d. HOME MADE AERIALS FOR TV AND FM. 10 designs and valuable data, 2/8, post 3d. RADIO CONTROLLED MODELS FOR AMATEURS. Theory and construction, various systems, 5/-, post 4d. PRACTICAL F.M. - F.M. Fully explained, with lots of circuits for home constructors, 5/-, post 4d. VALVE EQUIVALENTS. (Electrically at-a-glance) 5/-, SEND 3d. FOR FULL BARGAIN LIST. Please allow post and packing on orders under £1. REED & FORD 39, BURNLEY RD., AINSDALE, SOUTHPORT

## News from the Trade

### NEW CLIX CLIP

**T**HE latest TC.431 Ediswan Clix Crocodile Clip offers something new in such components. Brass-plated for easy soldering, it is made of single-piece spring steel for strength, adaptability and maximum electrical contact.

The clip has been designed so that plugs and pins in both English (3 mm.) and Continental (4 mm.) can

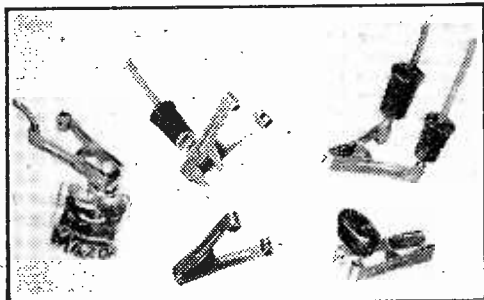

*Applications of the new Clix Clip.*

be plugged into the respective rings, leaving the jaws free for clipping. In the double-folds, spade plugs can be slipped in easily when required; again leaving the jaws free. Behind the teeth, wide jaws allow clipping over the valve caps.—Edison Swan Electric Co., Ltd., 155, Charing Cross Road, W.C.2.

### FLYING LEAD VALVE ASSEMBLIES

**B**IRIMAR are now able to offer a range of flying lead valves assembled on moulded bases suitable for chassis mounting and using the same fixing holes as the corresponding valveholders for plug-in valves. Two types of assembly are available; *unscreened*, with the valve mounted on a base only, or *screened*, with a close-fitting blackened metal can which provides electrical screening and conductive cooling of the envelope. Both these assemblies can be supplied with the bases moulded in nylon-loaded P.F., or in P.T.F.E. The nylon-loaded P.F. base has good electrical properties and is suitable for general use up to about 200 Mc/s, and the P.T.F.E. base, which is heat and moisture resistant with excellent electrical properties, may be used for all frequencies under arduous conditions such as in situations of high humidity.—Standard Telephones and Cables Ltd., Footscray, Sidcup, Kent.

### "ELIZABETHAN DE LUXE" TAPE RECORDER

**T**HE latest addition to the Elizabethan range is the de luxe portable tape recorder, incorporating the Collaro tape transcriber.

This new recorder has automatic press button controls, three speeds—15in., 7½in. and 3½in. per second, twin-tracks, four heads and automatic track reversal.

The connection between the deck and the amplifier is effected by the use of a patented control system.

The frequency response of the recorder extends to 16 Kc/s with standard CCIR compensation for reproduction of pre-recorded tapes.

Other facilities of the recorder include the internal mixing of microphone and gram inputs, a continuously variable tone control and outputs for external loudspeakers, headphone monitoring and a feed for an external Hi-Fi amplifier. The internal 9in. × 5in. elliptical loudspeaker produces an output of 3½ watts.

The Elizabethan De Luxe is styled in forest green with gilt fittings and is supplied complete with 1,800ft. L.P. tape and spare spool, moving coil microphone and a radio/gram interconnecting lead.

List price is 65 guineas complete. A table version in ebony and sycamore veneers is available at 69 guineas.—E.A.P. (Tape Recorders), Ltd., 9, Field Place, St. John Street, E.C.1.

### NEW EKCO "PICK-ME-UP" PORTABLE RADIO

**E.** K. COLE, LTD., announce the introduction of a new battery-operated radio receiver known as the Ekco "Pick-Me-Up" (Model BP257).

This attractive receiver—hardly larger than a lady's handbag—is the first Ekco model to incorporate the printed circuit technique. It has many outstanding features, including a large easy-to-read tuning scale, small dimensions (8½in. high × 10½in. wide × 5½in. deep), lightweight (approximately 7½lb. with batteries), and a high-flux 6in. × 4in. elliptical moving-coil speaker. The receiver employs a "Batry-max" Type B126 for H.T. and an Ever-Ready Type AD35 for L.T.

Model BP257, which covers medium and long waves, incorporates the latest type low-consumption valves and has a built-in "Ferrite" rod aerial.

Easy to carry, the Ekco "Pick-Me-Up" has a folding carrying handle and is attractively finished in imitation grey lizard skin with a cream polystyrene top panel. List price, £9 1s. 3d. Purchase tax, £3 10s. 9d. Total price, 12 gns.—E. K. Cole, Ltd., Southend-on-Sea, Essex.

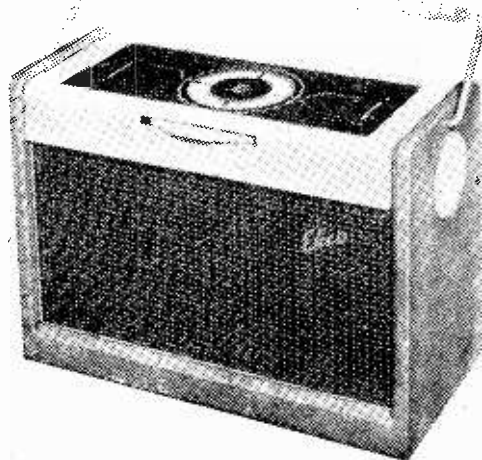

*The new Ekco "Pick-me-up" Portable (Model BP257).*

# Programme Pointers

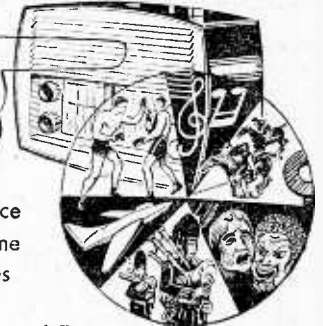

## Festival of Revivals

**R**ADIO plays divide themselves into three categories: (a) those which are taken more or less from the repertory of classic drama and put "on the air" as they stand (b) novels dramatised for broadcasting, and (c) plays specially commissioned for the studio. These latter have varied enormously in quality and are usually fair to average in entertainment value. But of the better ones the BBC has recently held a two-week festival of revival, and some truly excellent examples have been brought back. A full list makes interesting reading: "Danger," by Richard Hughes, and "The Squirrel's Cage," by Tyrone Guthrie; "Socrates Asks Why," by Eric Linklater; "Oranges and Lemons," by Philip Wade; "The March of the '45," by D. G. Bridson; "The Dark Tower," by Louis McNeice; "Money With Menaces," by Patrick Hamilton; "The Rescue," by Edward Sackville-West, and "The Homecoming," by Peter Hirche, translated by A. L. Lloyd, a Radio Italiana Prize Play of 1955. The series covers the whole period of broadcasting.

All three classes demand different techniques of writing as well as methods of production. And none more so than this specially contrived type. Each one of those selected for this festival was a masterpiece of its genre, and covered the widest range of interest; the romantic disillusionment of "The March of the '45," the historical and philosophical disquisitions of the war-time "Socrates Asks Why," or the two life-stories covering forty years of "Oranges and Lemons," etc. The festival might be compared to similar ones the film world has given us, except that most of these radio plays have been specially remade. It was one of the most interesting and revealing things we have had for some time.

## "The Coast"

The first of six Sunday programmes on "The Coasts" dealt with Land's End. Introduced by Brian Vesey-Fitzgerald and comprising records of miners, fishermen and farmers who live in a countryside of saints, legends and stone buildings the story smacked more of the countryside than the splashing waves, though one heard these and the gulls as in "Desert Island Discs." Pleasant enough, but rather falling between two stools.

## A Good Half-hour's Fun

"A Proper Charlie," the new weekly Charlie Chester feature, with Deryck Guyler, Edna Fryer, Len Lowe, Marian Miller and the Radio Revellers, provided a good half-hour's fun the first time I sampled it. Charlie Chester can keep five minutes or so of quick patter going with the best of them. Whether his adventures or misadventures are sad or gay, romantic or platonic, he knows how to extract every possible laugh. He is well served by his script-

## Our Critic, Maurice Reeve, Reviews Some Recent Programmes

writers, Charles Hart and Bernard Botting, and the producer, Leslie Bridgemont.

## Talks

It is a natural as well as an oft-repeated moan that this radio age prevents us from thinking for ourselves. With voices coming at us all day long from all corners of the world and on every conceivable subject is it any wonder if multitudes should follow other people's opinions? After all, they are the experts, they must know best, they wouldn't be on the BBC if they didn't! The best of radio talks leave us free to draw our own conclusions: they either present a point of view on some important and interesting fact, free from dogmatic assertion, finishing up, as if to say, "This is my view. I do hope you will agree with me" (the bad talk ends "If you don't agree with me you're a bigger fool than I took you for"), or they offer us the facts of a case, free from any judgments or conclusions, and merely invite us to draw our own.

Of this latter kind the series "The Middle East"—six of which have been given at the time of writing—is a very good example. Narrated by Edward Ward, produced by Joe Burroughs and covered by a number of on-the-spot reporters, it told the story of this vexed problem from each of the countries in turn, copiously rather than succinctly, filled us with a variety of pictures and facts, and then left us quietly to ourselves and the processes of digestion. Each was highly interesting, instructive and entertaining by virtue of the fact that we were not "lectured" or "talked at," but given data and particulars of something as though we had looked it up for ourselves in the encyclopaedia. I felt much more able, after listening to them, to get an overall picture of this very picturesque part of the world; as well as being helped to clearer thinking on the tremendous events now talking shape there.

## A Good Performance

The play "César," by Marcel Pagnol, translated and adapted by Barbara Bray, completed a beautiful triptych, and became a notable contribution to the Monday night series. I praised the other two, "Marius" and "Fanny," when they appeared; "César" made a worthy conclusion. Carrying the burden through all three pieces of the monumental bar-owner—a part made memorable on the screen by the late Raimu—James Hayter gave us his best radio performance. Frank Atkinson as Panisse, Jean Kent as Fanny, Oscar Quirk as Césariot, as well as a host of others, brought deep breaths of reality and atmosphere to their parts. I hope it will be repeated in the not too distant future.



**SOUTHERN RADIO'S WIRELESS BARGAINS**

**TRANSCEIVERS.** Type "38" (Walkie-Talkie). Complete with 5 Valves. In Metal Carrying Case. Ready for use. Less external attachments, 30/- per set. **ATTACHMENTS** for use with "38" **TRANSCEIVER** : HEADPHONES, 15/6 ; THROAT MICROPHONE with Lead & Plug, 4/6 ; JUNCTION BOX, 2/6 ; AERIAL, 2/6.

**TRANSCEIVERS.** Type "18" Mark III. TWO UNITS (Receiver & Sender) contained in Metal Case. Complete with Six Valves, Microammeter, etc. **LESS EXTERNAL ATTACHMENTS, £4/10/-.**

**TRANSMITTERS.**—T.1154—Complete all valves, etc., etc. Perfect order. 3 frequencies. £2/7/6 in transit case. Delivered U.K.

**RECEIVERS.** Type "109." 8-Valve S.W. Receiver with VIBRATOR PACK for 6 Volts. Built-in Speaker, METAL CASE, £5.

**BOMBSIGHT COMPUTERS.** Ex-R.A.F. BRAND NEW. A Wealth of Components. GYRO MOTORS, REV. COUNTERS, GEAR WHEELS, etc., etc. Ideal for Model Makers, Experimenters, etc., £3.

**LUBRA HOLE CUTTERS.** Adjustable 2 1/2 in. to 3 1/2 in. For Metal, Wood, Plastic, etc., 7/-.

**RESISTANCES.** 100 ASSORTED USEFUL VALUES. Wire Ended, 12/6 per 100.

**CONDENSERS.** 100 ASSORTED. Mica, Metal Tubular, etc., 15/- per 100.

**PLASTIC CASES.** 14in. x 10 1/2 in. Transparent. Ideal for Maps, Display, etc., 5/6.

**STAR IDENTIFIERS.** Type I-A-N. Covers both Hemispheres, in Case, 5/6.

**CONTACTOR TIME SWITCHES.** In Sound-proof Case. Clockwork Movement. 2 Impulses per sec.. Thermostatic Control, 11/6.

**REMOTE CONTACTORS** for use with above, 7/6.

**MORSE PRACTICE SET** with Buzzer on Base, 6/9. Complete with Battery, 9/6. **MORSE TAPPERS,** Std. 3/6 ; Midget, 2/9.

**METERS & AIRCRAFT INSTRUMENTS.** Only need Adjustment or with broken Cases. **TWELVE INSTRUMENTS,** including 3 brand new Aircraft Instruments. 35/- for 12.

**CRYSTAL MONITORS.** Type 2. New in Transit Case. Less Valves, 8/-.

*Postage or Carriage extra. Full List of RADIO BOOKS, 2 1/2 d.*

**SOUTHERN RADIO SUPPLY LTD.,**  
11, LITTLE NEWPORT ST., LONDON, W.C.2. GERrard 6653

**THE HAM'S SHOP**

Cheapest Television and Electrical Shop in Great Britain.  
45, WINETAVERN ST., BELFAST, NORTHERN IRELAND  
Phone : 31849.

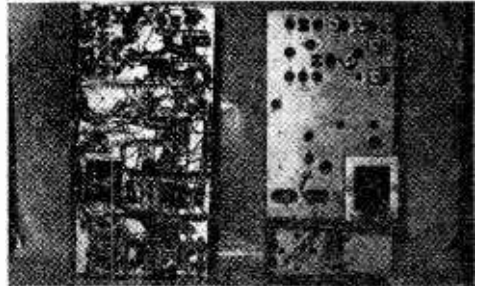

**HORN UNITS.**—New, £2.10.0 ea. (Special Bargain unrepeatable.)  
(Deliveries within 14 days—Always at your service.)  
Please enclose S.A.E. with enquiries.

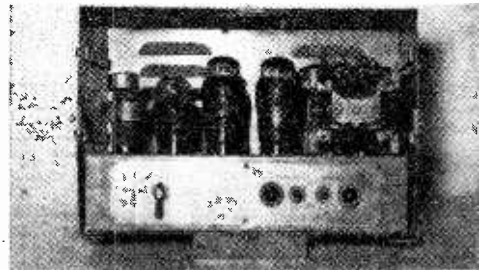

**TELEVISION CHASSIS (NEW).** £2.10.0 ea., plus carr. and pk., 7/6.  
**AMPLIFIERS.**—15 w., 12 v. input. Suitable for P.A., Sports Meetings, etc., etc., £4.10.0 ea., plus carr. and pack., 15/-.

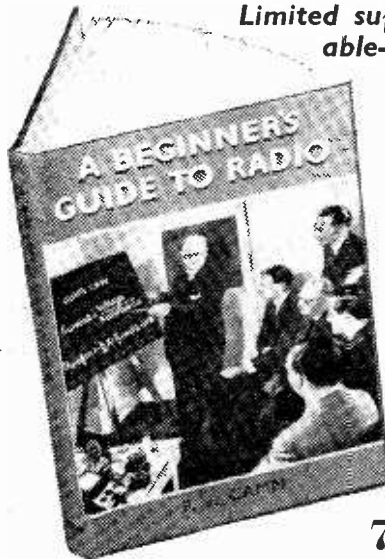

Limited supplies of this important radio book are still available—only 7s. 6d! (It will be impossible to repeat the next printing at this money-saving price.)

F. J. Camm's

**A BEGINNER'S GUIDE TO RADIO**

SPECIALLY planned for teachers and students, this elementary first course in radio transmission and reception, written in simple language which the very beginner will understand, approaches the subject from a new angle. The student is taught how to build simple receivers and the theory and function of each part is explained as the student builds. The teacher is given the basis of instruction.

**CONTENTS**

- Understanding the Circuit . One-Valver into Two-Valver .
- Adding a Further L.F. Stage . Purpose of Grid Bias . Automatic Bias .
- Purpose of Decoupling . Adding Tone Control . Ohm's Law . Meters .
- Testing Without Instruments . Inductance and Capacity . Condensers .
- Superhet . Transmission . Electric Currents . Detector Valve .
- Methods of Coupling Valves . Transformer and Output Stage . Reading a Circuit .
- Using Testing Instruments . Characteristic Curve . The Loud-speaker .
- Mains Valves . Rectifiers, Chokes and Smoothing . Accumulators . Abbreviations . Table . Index .

ONLY 7s. 6d.

With 104 illustrations

27 Lessons by F. J. Camm (Editor of this Journal).

Also available—

**MAGNETIC RECORDING HANDBOOK** 21s. (22s. by post).

**QUESTIONS AND ANSWERS ON RADIO AND TELEVISION** 6s. (6s. 6d. by post).

**FROM ALL BOOKSELLERS**

... or in case of difficulty 8s. 1d. by post from Book Dept., George Newnes Ltd., Tower House, Southampton Street, London, W.C.2. (Full list of books on radio and television gladly sent free on request).

# NEW!

1956 EDITION of  
Our Supa-Handbook,  
"The Home Constructor"  
JUST OUT! incorporating

- \*23 CIRCUITS.—Super hets., T.R.F. Sets, Amplifiers, Feeder Units, Test Equipment, etc.
- \*SUPERHETS.—Full constructional details, supra-simplified diagrams for building a variety of superhets.
- \*COIL PACK.—Full constructional details for building a superhet coil pack.
- \*CAR RADIO.—Full constructional details.
- \*BATTERY CHARGER, details for building a CHAP charger.
- \*B.P.O. UNIT.—For converting your receiver to "Communications."
- \*I.F. STAGE.—Adding an I.F. Stage to increase your set's gain and selectivity.
- \*MAGIC EYE.—Details for incorporating a Tuning Indicator for accurate tuning.
- \*RADIO GEN.—Pages of Information, Resistance Colour Code, Formulae and "know-how."
- \*CATALOGUE.—Profusely illustrated price list of components. All for 2/6 (plus 3d. post). Send for your copy to-day!

**SUPACOILS** (Dept. P.8)  
21, Markhouse Road, London, E.17  
Telephone: KEY 0805

## LYONS RADIO LTD.

Dept. M.P., 3, GOLDHAWK ROAD,  
SHEPHERDS BUSH, LONDON, W.12.  
Telephone: SHEPHERDS Bush 1729.

**HIGH STABILITY RESISTORS.**—Miniaturised 1-watt ± 10% specially selected kit to give you a complete coverage of preferred values between 10 ohms and 3 megohms. Kit contains one each of 60 different values with resistance clearly marked on each. PRICE per KIT, £1, post 9d. Values up to 10 megohms can also be supplied. Smaller quantities your choice at 5/6 dozen, post any quantity 1/-.

**WAVEMETER TYPE W.1239.**—Frequency coverage 30-51 Mc/s. Rectifier type employing valves type VR92, 635, 6X5 and V1103 tuning indicator. The tuning control is fitted with a Mullhead slow-motion drive, skirted type, with vernier scale. The instruments have their own built-in power packs for operation from 200-250 v. A.C. 50 cycle mains. Housed in copper-lined instrument cases 16 x 10 x 9 in. A top-grade job which would make a useful addition to any laboratory or test-room and at a price well below the value of the components alone. PRICE ONLY 59/8, carriage 7/6.

**INDICATOR UNITS TYPE 182.**—Contain cathode-ray tube type VCR517, 3-VR35s. 4-VR65s. 14-5U4, pots, resistors, condensers and a wealth of other useful components. PRICE ONLY 55/-, or less 5U4, 45/-, carriage 7/6.

**CROCODILE CLIPS.**—Always a useful item to have handy. Strong spring ensures firm, positive grip. ONLY 5/6 dozen, post 6d.

**TELEPHONE SETS TYPE "F."**—Utilise P/O type hand set with twin call bells, buzzer and hand generator for calling. Operate from 2-1 1/2 v. cells (exact type to fit 3/9 ea. if required). Supplied in case approx. 11 x 9 x 8 in. In good condition and working order. Ideal for two-way communication in the Home, Office, Factory, etc. PRICE per PAIR, £7.10.0, carriage 5/-.

## G.W. SMITH & CO (RADIO) LIMITED

3-34 LISLE STREET, LONDON, W.C.2  
TELEPHONE: GERRARD 8204/9155

### DEAF AIDS

Complete units with three sub-miniature valves, volume control, tone control, crystal mike, etc., less only outside bakelite case, 19/6 each. 30 ohm earpieces to match, 3/6. Leads, 1/-.

Batteries, 2/9 pr. Additional components required to make a pocket radio; crystal diode, 10d. Trimmer, 1/-.

Midget dual range coil, 2/6, or coil wound on ferrite rod aerial, 8/9. Spare valves CK505, 2/6. Spare pots 1 meg./switch, 1/-.

**AERIAL WIRE.** 300 ft. reel of bare copper wire, 3/6.

**CRYSTAL MIKE INSERTS,** 4/6 each.  
**JACK PLUG LEADS.** 6ft. screened lead with 2 standard jack plugs, 3/- each.

### GRAM MOTOR BARGAIN.

Garrard 200/250 v. motors and turntables, adjustable speed, 0-45 r.p.m. Ideal for L.P. records, 22/6 each.

### TRANSISTOR TRANSFORMERS.

Really minute. Intervalve or output. Large stocks available, 2/6 each.

### COLLINS MOD. TRANSFORMERS.

Brand new, push-pull 807-807, 12/6 each.

**AR88 RECEIVER SPARES.** Brand new ceramic switch assemblies in original cartons, 17/6 each. Brand new geared drives, 10/6.

**FIELD TELEPHONES.** Type Don. mk. 5. Ideal for inter office or house communication. Supplied complete with handset, buzzer, bell, etc., and 2 1.5 v. cells to operate. Price 39/6 each.

### TRANSFORMER BARGAINS

1. Input 230 volt. Output 5, 10, 15, 20, 25 or 30 volt 5 amp. Only 29/6 each.
2. Input 230 volts. Output 7, 14, 21 or 28 volts 12 amps., 42/6 each.

**No. 234 POWER UNITS.** Input 200/250 volt A.C. Output 240 volt 150 ma., 6.3 v. 6 amp. Double choke and condenser smoothed. Fitted moving iron meter to read input A.C. volts and D.C. output volts. 19in. rack mounting. Price 69/6 each.

**12 VOLT ROTARIES.** Input 12 volt D.C. Output 180 volts 65 ma. fully smoothed. Housed in grey case, 19/6 each.

**CHOKE BARGAINS.** 10 h. 40 ma., 3/6. 9 h. 100 ma., 7/6. 30 h. 20 ma., 3/6. 8 h. 100 ma., ported, 8/6. 20 h. 175 ma., 10/6. Swinging choke, 3.6-4.2 h. 250 ma., 10/6.

**METER SWITCH.** 1 pole, 12 way, 8 bank yater, 7/6.

**VALVE SPNS.** VU111, 1/9. 5130, 4/6. APR4, 2/-, 6SN7, 6/6. 6U7, 4/6. 5V4, 8/6. 5Z4, 7/6. VT61a, 1/6.

**CONDENSER BARGAINS.** 103 mfd. 25 v., 9d. 50 mfd. 25 v., 1/-, 8 mfd. 450 v., 1/9. 32 x 32 mfd. 450 v., 4/6. 100 x 200 mfd. 350 v., 7/6. 2,000 mfd. 50 v., 4/6.

**HOURS OF BUSINESS:** 9 a.m.—6 p.m., Thursday, 1 p.m. Open all day Saturday.

Please print name and address clearly and include postage or carriage on all items.

## BUILD THIS FOR 49/6



Build this exceptionally sensitive twin-diode radio. Uses unique assembly system and can be built by anyone without any radio knowledge whatever in 45 minutes. Handsome black-crackle steel case with specially made black and gold dial with stations printed. Size of radio only 6 1/2 in. x 5 1/2 in. x 3 in. Covers all Medium and Long waves—uses one only all-dry battery. H.T. consumption only 1 to 1.5 mA. Ideal for Bedroom, Garden, Holidays, etc. Many unsolicited testimonials. Mr. Norton, of Oxford, writes: "Yesterday evening on the Medium waveband, I counted 32 separate stations: I am very pleased with the set, which is well worth the money. Total building cost—Everything down to last nut and bolt—49s. 6d., including post, etc., with full set of clear, easy-to-follow plans (For Headphone Reception). Cost of Extra Valve, Speaker, Parts, etc., 38s. 6d. All these fit inside Case or parts sold separately. (Priced Parts Lists, 2/-) Orders despatched by return. Overseas orders welcomed. Limited Quantity—Send To-day.

**CONDOR ELECTRONICS (PW8),**  
39 QUEEN'S ROAD, BRIGHTON, 1

## VALVES

### SAME DAY SERVICE

### All Guaranteed New and Boxed

1.4v. midget, 1R5, 1S5, 1U5, 174, 3S4, DAF91, DF91, DK91, DL92, DL94 : any 4 for, 27/6  
1A7GT12/6 8U4GT15/-DK32 12/6 HVT3A  
1C5GT11/-8V6G 7/6 DK32 7/6  
1D5 11/6 8V8GT 7/6 DL33 11/6 8KR20C  
1H5GT 6X4 7/6 DL35 11/- 10/6  
1N5GT 11/6 6X5GT 6/9 EB91 6/9 KT63 7/6  
1N5GT 7B7 8/6 EB33 7/6 MU14 9/-  
1R5 8/6 7C6 9/6 EC41 10/- PC74 9/6  
1S4 7/3 7H7 7/6 EC40 10/- PCF80 9/-  
1T4 7/3 7S7 9/6 13/6  
1U5 7/3 7Y4 8/6 EC81 10/- PEN36C  
3A5 9/- 10C1 13/6 EC83 10/- 18/-  
3BE5GT11/6 10C2 10/- EC81 6/- PEN45 18/-  
3S4 7/6 10F1 10/- ECF90 13/- PEN46 7/-  
3V4 8/6 10LD11 EC35 PEN38 23/9  
5U4C 8/6 10/6 11/9 PL81 11/9  
5Y3GT 7/9 12A7T 8/9 ECH42 PL82 9/6  
5Z4G 9/- 12AU7 9/6 10/8 PL83 12/6  
6AL5 5/- 12J7GT 9/6 ECH80 10/- PY80 10/-  
6AR5 6/9 9/6 EC181 10/- PY81 10/-  
6AM6 7/6 12K7GT 9/6 EF37A PY82 9/6  
6AQ5 7/6 12K9GT 6/6 EF39 10/6 UZ30 18/-  
6AT8 8/6 12/6 EF39 8/6 UZ2 8/6  
6BA6 7/6 12Q7GT EF40 17/6 U25 14/6  
6BB6 7/6 9/6 EF41 10/- U26 15/6  
6BW6 7/9 12Z3 7/6 EF42 13/- U50 7/6  
6BX6 7/6 14S7 15/6 EF50 7/6 U7 7/9  
6CS 10/- 30L1 10/9 EF50 7/6 UAF22  
6FG6 7/6 25L6GT 8/6 EF85 9/6 11/9  
6F15 13/- 25Z4G 9/6 EF86 12/6 UBC41 9/-  
6J6 6/- 35L6GT 9/6 EP91 7/6 UCH42  
6KT6 7/6 35Z4GT 8/6 EF92 6/6 UCF1 10/9  
6L6GT 8/- 35Z6GT 9/- EL32 6/6 UF41 9/6  
6KR6 6/- 50L6GT 8/6 EL38 23/9 UL14 10/9  
6K8G 8/6 AZ1 11/6 EL41 11/6 UU7 11/6  
6K8GT 9/6 CCH35 11/- EL34 11/6 UY41 9/-  
6L8 10/6 D15 7/- EM34 10/6 VP48 15/6  
6LD20 9/6 DAC321/6 EY31 11/6 W71 6/6  
6QNTGT 9/6 DCC90 9/- EZ40 8/6 X79 12/6  
6S7GTGT DF33 11/6 EZ80 9/- Y63 7/6  
8/6 DH77 8/6 G232 15/- Z77 7/6  
Postage 5d. per valve extra.

## READERS RADIO

24, COLBERG PLACE, STAMFORD  
HILL, LONDON, N.16. STA. 4587

# Open to Discussion



*The Editor does not necessarily agree with opinions expressed by his correspondents*

## A Radio Jack

**SIR**,—Mr. J. B. Hughes's little radio jack (featured in your February issue) deserves better housing than he has given it. His tin can, however well soldered and crackled, remains recognisably a tin can. May I suggest the little ex-A.M. control box currently available on the surplus market for a few coppers? This is ideal, and the switch can be used for station changing.

It says much for the jack that the first station tuned in with it was Radio Luxembourg. Granted, it was plugged in to a superbly sensitive amplifier. But still, Radio Luxembourg on a crystal diode, with a few feet of flex for aerial!—N. V. DINSDALE (York.)

*Whilst we are always pleased to assist readers with their technical difficulties, we regret that we are unable to supply diagrams or provide instructions for modifying commercial or surplus equipment. We cannot supply alternative details for receivers described in these pages. WE CANNOT UNDERTAKE TO ANSWER QUERIES OVER THE TELEPHONE. If a postal reply is required a stamped and addressed envelope must be enclosed with the coupon from page iii of cover.*

## Good Results

**SIR**,—After searching round for a good long time for a good general purpose amplifier, I at last hit on the circuit given in a copy of PRACTICAL WIRELESS, April, 1949, issue, and have since built it to specification, using two 6SC7 and two 6V6 in push-pull. I don't know anything about "Hi-Fi," but for simplicity and effective reproduction of records and microphone speech this unit is going to be ideally adequate for my church hall social activities. The unit is built on the chassis of a 132 $\alpha$  radar unit and housed in the proper case making the whole thing very robust and portable. The only addition I have made is the inclusion of a 150 mA meter in the H.T. return so that a permanent check is kept on consumption, which is only about 80 mA. I think this must be about the cheapest 15-watt general purpose amplifier you've ever illustrated, or that anyone could hope to build, even from scratch. And I would say that anyone with a good "spares" box would have a most satisfying minimum of outlay for a maximum of pleasurable results.—REV. J. RODGER (Grange-mouth).

## Correspondent Wanted

**SIR**,—I am very much interested to correspond with the experimenters, technicians and students and graduates of all Radio Institutes—SH. NISAR AHMAD, House No. E-15/4, Sheedi Village Road, Karachi, 2, Pakistan.

*[Perhaps members of Radio Societies will get into direct touch with this overseas reader.—Ed.]*

## 1939 Portable

**SIR**,—I have for some time been following Thermion's quest for a truly compact pocket receiver, although not necessarily subscribing to the idea that such a set is of great use. I do not

consider that such a set is at all difficult to design, but to be of real use battery life should be reasonable. Mr. Freeman (November, 1955) states a possible combination, but to my idea the simple regenerative detector will provide good headphone or earpiece strength. In fact, in 1939, I myself had a perfectly good pocket receiver, approximately 4in. by 4in. by

2in., this including batteries. The circuit was a simple 1A5 power pentode as regenerative detector. Batteries were a home-made 24 volt H.T. (eight of 3-volt penlight type) and a large single torch cell.

A short throwout aerial was used, normally 6ft.

of wire simply dropped on the floor was sufficient. Although I have long since given up work on portables I feel that experiments along these lines would give useful results, but I feel that tuning is inevitably restricted to mica dielectric type condensers in the interests of compactness.—R. SHATWELL (Oldham).

## Condenser Mounting Hint

**SIR**,—I have just had a tip which I think is worth passing on. In the Seven-Five Superhet the Jackson 500 pF two-gang is rather low, and there is a little difficulty in lining up the dial assembly. Osmor informed me they had turned the feet of the two-gang upside-down and, after mounting grommets, was a good fit. This I found to be correct.

Thank you for a good circuit, which I find performs excellently.—T. OSBORNE (Hillingdon).

## Tape Recorder Experiences Wanted

**SIR**,—Would you help me to establish contact with anyone who has built a Sound Master or P.W. Tape Recorder?

I have just completed a Sound Master, and would like to exchange experiences on the operation of the same. Any advice on microphones, matching, tapes, etc., and, in general, anything that will enable me to get the utmost from this most fascinating hobby, would be appreciated. I am having trouble with capstan vibration—has anybody else had this trouble?

All letters will be acknowledged.—T. MAISLAND (3, Rimington Avenue, Richmond, Yorks).

## Valves for Battery Portables

**SIR**,—Reading the article in your June issue it is easy to obtain a somewhat misleading impression of the current trends of battery valves.

Judging from the article, there would seem to have been no progress in the design of battery valves since 1939! This, of course, is not so, and one significant development seems to have escaped the writer's notice. Two of the chief aims in the design of

portable receivers are small size and economy of operation. To this latter end surely lower battery drain is of primary interest.

With the above in mind, constructors cannot ignore the 25 mA range of battery valves, such as the Mullard "96" series (DAF96, DF96, DK96 and DL96). These valves can be operated either in a 25 mA chain or in parallel, each filament being rated at 1.4 volts, 25 mA and the output valve having a double filament in the same way as the output valve referred to in the article. In addition to the lower filament consumption the H.T. drain is considerably reduced with the 25 mA series of valves; a standard four-valve superhet takes a current of the order of 18 mA with the 50 mA types and only about 10 or 11 mA with the types mentioned above.—J. B. WRANGHAM (S.W.7).

#### A 3½ inch Oscilloscope

SIR,—On glancing through a copy of the July PRACTICAL WIRELESS in the lab., one of our technical staff noticed a slight error in Fig. 9, on page 326. In the Schmidt amplifier circuit the capacitor C2 should be taken to chassis and not to the junctions of R2, R3, R4 and R5. The circuit as shown will be lacking in gain.

In passing the writer would like to comment that this particular circuit is an exceptionally good one for 'scope work and has been used in this firm's "lab." on several occasions with first-class results.—JAMES S. KENDALL (Managing Director Kendall and Mousley) (Edgbaston).

#### Ex-Service I.F.s\*

SIR,—I hope the following other frequencies will be of help to readers:

R3547, 45 Mc/s; R1155A, 280-650 Mc/s?; BC221, 125-20,000 kc/s; R25, 4.3-7.5 Mc/s, 18-31 Mc/s; RDF1, 1.5 m. (?); BC624A, 100-156 Mc/s; R71, 124 Mc/s; M1-19467A, 2-10 Mc/s, 1-5 Mc/s; APW4790, 1.5 m. (?); R23/ARC5, 545-1,850 m.; R26/ARC5, 100-49 m.; R27/ARC5, 49-33 m.; R28/ARC5, 100-150 m.; type 68, 3-5 Mc/s; BC778, 500 kc/s; R6, 3-7 Mc/s; ZC8931, 1.5 m. (?); type 53, 2.4-6.5 Mc/s, 4.8-13 Mc/s; APN4, 550-650

## TRANSMITTING TOPICS

(Concluded from page 388)

arrangement as shown in Fig. 10. Due to the use of a "thick" radiator, the feed impedance is reduced to around some 100 ohms as compared with the analogous folded aerial of Fig. 9, but the system is inherently a broader band due to the use of a "fat" centre radiator.

There is the possibility of running fan wires from the radiator apex to every radial. For a four-radial arrangement this would give a 25-fold step-up of impedance, i.e., a feed impedance of 750 ohms. However, if the sloping "fan" wires are thinner than the centre radiator, this step-up would be reduced. If the centre radiator itself is "fattened" by using

m.; CC7-46104, 1.5-3 m.; R9 mk. 1, 2-5 Mc/s; CCT/CB7, 4C129, 550-190 kc/s; type 88, 38-43 Mc/s.—M. C. SYKES (Gloucester).

#### F.M. Receiver

SIR,—I have been continually experimenting to extend the tuning range of the F.M. receiver described in your issue dated December, 1955, basing my experiments on the advice you sent me. The results have been promising, the range being increased by about 3 Mc/s. You say that your tuning gang has a maximum capacity of 12.2 pF. Mine tunes from 3-10 pF, and doubtless this is a major reason for the reduced range.

With the slight increase of range that I have obtained came an increase of quality and sensitivity and a decrease of background noise. The other day the reflector of my home-made aerial fell off and reception from Wenvoe (100 miles away) increased considerably. Reception from the "local" station, Wrotham, decreased of course. At about 10 a.m. this morning I received a German station on about 93.8 Mc/s, which I think gives credit to the design of the set. Thanking you again for your advice.—A. J. LEWIS (Basingstoke).

#### Re Organ Tone Controls

SIR,—Reference the letter from A. Dickenson in your July, 1956, issue, I greatly simplified tone-changing on my Electronic Keyboard by fitting, in place of the original tone switches, a nine-way multi-contact push-button unit as used on some types of radio receiver.

The wiring of the P.B. unit was a bit complicated to work out. First, I made a circuit diagram of the contact positions of the original switches that produced nine of the most pleasing tones, and from this wired the P.B. unit so that it is only necessary to press one button for any one of the nine tones. As is usual with radio P.B. units, the pressing of any one button automatically cancels the previous one used.

I would add that the P.B. unit was obtained from one of your advertisers of surplus goods.—J. V. FOSTER (Ipswich).

two or more wires, the centre impedance would again be reduced further, but the system would become even more of a "broadband" device. Further elaborations include conical and truncated conical wire skeleton forms of conical radiator, all of which can be made to form very wideband ground plane types of vertical radiators.

While "broadbanding" makes the system useable over a broad frequency range, so much so that a system designed on a centre frequency of, say, 11 Mc/s will operate from 7 Mc/s to 28 Mc/s as a broadband ground plane type vertical, it should be noted that the capacity increase due to the additional wires will also improve "below cut-off" operation when loaded up on 3.5 Mc/s and even for topband emergency use truly a versatile aerial!

The Editor will be pleased to consider articles of a practical nature suitable for publication in "Practical Wireless." Such articles should be written on one side of the paper only, and should contain the name and address of the sender. Whilst the Editor does not hold himself responsible for manuscripts, every effort will be made to return them if a stamped and addressed envelope is enclosed. All correspondence intended for the Editor should be addressed: The Editor, "Practical Wireless," George Newnes, Ltd., Tower House, Southampton Street, Strand, W.C.2. Owing to the rapid progress in the design of wireless apparatus and to our efforts to keep our readers in touch with the latest developments, we give no warranty that apparatus described in our columns is not the subject of letters patent. Copyright in all drawings, photographs and articles published in "Practical Wireless" is specifically reserved throughout the countries signatory to the Berne Convention and the U.S.A. Reproductions or imitations of any of these are therefore expressly forbidden. "Practical Wireless" incorporates "Amateur Wireless."

**SEE ALL THESE FINE BARGAINS AT**  
*The Walk-around Shop*

**I.F. Amplifier Unit.** 460 Kc/s. with IT4 Brand New and Boxed. Fully screened in plug in Box. Size 2½ in. x 1 in. x 4½ in. Price 10/- ea. with circuit. Plus 1/- p.p.

**Miniature I.F. Strips.** Size 10½ in. x 10½ in. x 3 in. frequency 9.7 Mc/s. Line-up: 2 EF.92's and 1 EF.91 I.F., amps. EB.91 DET/AGC., EF.91 AGC Amp. and EF.91 limiter. Circuit supplied. Price, less valves, 8/- ea. post paid.

**Line Testing Meter Unit.** With one 0-30 mA and one 0-100 v. 2½ in. Panel Mt'g. Meters. P.O. Switch, 3 Panel Mt'g Fuse Holders in strong polished wooden case with lined lid and handle. Size 8 in. wide x 5½ in. x 5½ in. Price 15/- each, plus 2/6 p.p.

**Command Receivers.** BC-453-B 190-500 Mc/s, £2.17.6 ea. BC-454-B 3-6 Mc/s, £1.5.0 ea. BC-455-B 6-9.1 Mc/s, £1.5.0 ea. Fully valved—less Dynamotors (Not New). Plus 3/- p.p.

**Command Transmitters.** BC-458-A 5-3.7 Mc/s, BC-459-A 7-9.1 Mc/s, £2 ea. Fully Valved—less Dynamotors (Not New). Plus 3/- p.p.

**A.R.88.** Ceramic Wafered Range Switch Assembly. 8 wafers mounted on chassis measuring 9 in. x 9 in. x 3½ in. Spindle length 15 in. Price 17/6. Plus 2/- p.p.

**Vibrator Packs (Mallory).** 12 v. input 150 v. 40 mA. Size 5½ in. x 5½ in. x 3 in., 17/6 ea. 12 v. input 275 v. 80 mA. Size 5½ in. x 5½ in. x 3 in., 25/- ea. 6 v. input 275 v. 80 mA. Size 4½ in. x 6 in. x 4½ in., 35/- ea. With harness. Plus 2/6 p.p.

**Throat Microphones Type TS30.** U.S. manufacture. Complete with elastic strap. Lead terminating at plug PL291. New and Boxed, 2/3 post paid. Sockets available, 6d. each.

**R.F. Units.** R.F.24 20-30 Mc/s, switched tuning, valved, 9/6 ea.; R.F.25 40-50 Mc/s, switched tuning, valved, 9/6 ea.; R.F.26 50-65 Mc/s, variable tuning, valved (New), 25/- ea. Packing and postage 2/- ea.

**Insulating Tape.** Perfect condition, ½ in. wide, 25 yd. reels. Foiled in tins. Price 1/3 each. Post & Pkg. 8d.

**Make a Miniature Pocket Radio.** Complete Kit; £2.6.0. Send for full details.

**Note.**—Carriage prices quoted apply only to England and Wales. ORDERS and ENQUIRIES to DEPT. 'P.'

**PROOPS BROS. LTD.** Telephone LANgham 0141  
52 Tottenham Court Road, London, W.1  
Shop Hours: 9-6 p.m. Thursday: 9-1 p.m. Open all day Saturdays.

**VIDEO ELECTRONICS**  
(LONDON) LTD. (Dept. 3)

Head office: 27, Bacon Street, London, E.1  
Works: 16/22, Bacon Street, E.1.  
Telephones: Bishopsgate 0419/0410.

**T.V. Tubes (17" £8, 14" £6, 12" £5, etc.)**  
Cheap, reliable high grade seconds and reconditioned C.R.T's, as supplied to the trade and leading Television Insurance Companies, prices from £3.

**Valves**  
Send at once for our useful list of cheap valves which will save money, we are the cheapest in the trade.

**Condensers**  
Electrolytics, bias, coupling, etc., etc., at give-away prices. All types stocked.

**Resistors**  
A fine stock of these at very low prices.

**T.V. & Radio Cabinets**  
A few 17" Table cabinets, new, ex famous manufacturer, and about 500 very handsome radio cabinets.

Send for stock list of speakers, valves, components and T.V. and Radio Spares.

All our goods are guaranteed.

**B**ENSON'S  
BETTER  
BARGAINS

**WAFER SWITCHES,** 1 pole 11-way, 2 Bank, 3/6. 4 P 3 W, 4 P 2 W, 1 P 5 W 6 B, 2/6.

**VIBRAPACKS,** see Mallory, 14 C, 12 v. to 150 v. 40 mA., smoothed. Black crackle, 16/6. (Post ½/- each). **RESISTORS,** hi-stab, close-tol. 10 Ω to 5.1 M., 1/- each. (Quantities available). Vitreous enamel 5 Ω to 100 Ω, 3 to 120 v. sizes, 1/6 and 1/8. **MOTORS,** synch. 230/250 v. A.C. 1 r.p.m. final, new, 22/6. **MOTORS,** synch. 3,000 r.p.m., 10 V.A. 100 v. 50 c.c., New, 10/-.

**METERS,** list available. **SPLITTERS,** 15 a. (G.E.C.), 1½/2 switch, 4 fuses, new, 15/6. **RX181,** 190/220 mc/s. with 1/V/R137, 1/CV16, 2/V/R136, 17/6. **I.F. AMPLIFIER 178** (for this), 13.0 mc/s, with valves, 15/6 (postage 2/6 each).

**AERIAL RELAYS** (co-axial) c/o 12/24 v., 7/6. **CLOCKWORK** (contactors, 2 impulses per sec., 8/6. U.S.A. type, small, 9/6. **R1355,** new improved type, 37/6 (carr. 7/6). **THROAT MICS.,** U.S.A. new, 2/6. **BENDIX RA-10,** 4 Wavebands, 8 valves, New, £3.10.0 (carr. 10/-). **RELAYS,** 2 break, 1/6. **R1355 1 F,** strips only, complete new, with valves, 25/-; less valves, 12/6 (post, 2/3). **BRAND NEW R.F. UNITS.** TYPES 26 or 27, 27/6; (Postage 2/6); RP24, RP25, Soited, 10/6. **I.F.T.'S** 10/13 mc/s., cased, new, 1/6. **R1155 Coil** packs, new, 12/6. Used, 9/6. **POWER PACK,** new, 200/250 v. A.C. input. Output 250 v. D.C. 80 mA., 6.3 v. 3 A and 24 v. 1A, D.C., 40/- (carr. 3/-). **CHOSES,** I.F. Ferranti, 10H, 150 mA., Screened, 7/6. Inht. 200 mA., 8/6; 5H, 200 mA., 5/6. **DYNAMOTORS,** D.C. 6 v. input, 250 v. 80 mA. output, 11/6. Filters for these 2/6. **EDDYSTONE** 12 v. to 190 v. 75 mA., cased, 15/-, (post 3/- each.) **Metal Rectifiers:** 600 v. 30 mA., 8/-; 500 v. 500 mA., 10/6. 1,000 v. 30 mA., 7/6.

**TRANSCEIVERS,** W/T 67, super-regen., with 4 1CGT valves and handset, 45/-.

List and enquiries. S.A.R.E. please! Terms: C.W.O. Postage extra. Immediate despatch.

**308 CLOVELL FIRST WEEK AUG.**  
Callers and Post Callers

**W.A. BENSON (PW), SUPER RADIO**  
308 Rathbone Rd., (Whiteapel) LTD., 118  
Liverpool, 13. Whiteapel, Liver-  
pool, 1. ROY 1130.

**FIRST-CLASS**  
**RADIO COURSES . .**

**GET A CERTIFICATE!**  
**QUALIFY AT HOME—IN SPARE TIME**

After brief, intensely interesting study—undertaken at home in your spare time—YOU can secure your professional qualification. Prepare for YOUR share in the post-war boom in Radio. Let us show you how!

**FREE GUIDE**

The New Free Guide contains 132 pages of information of the greatest importance to those seeking such success-compelling qualifications as **A.M.Brit.I.R.E., City and Guilds Final Radio, P.M.G. Radio Amateurs, Exams., Gen. Cert. of Educ., London B.Sc. (Eng.), A.M.I.P.E., A.M.I.Mech.E., Draughtsmanship (all branches),** etc., together with particulars of our remarkable Guarantee of **SUCCESS OR NO FEE**

Write now for your copy of this invaluable publication. It may well prove to be the turning point in your career.

**FOUNDED 1885—OVER 150,000 SUCCESSES**

**NATIONAL INSTITUTE OF ENGINEERING**  
(Dept. 461), 148, HOLBORN, LONDON, E.C.1

**OLIVERS OFFER**  
**GUARANTEED BARGAINS**

**I.F. Transformers,** 465 Kc/s, Litz wound, High "Q," cans 2½ in. x 2 in. x ½ in. 5/6 per pair.

**1 Meg. Pots.** D.P. Switch, long spindle, 3/3. **Output Transformers,** 6,000 to 23 ohms, 4/-.

**5 in. P.M. Speakers.** 14/6.

**Dual wave Ferrite-rod Aerials,** Litz wound, 8/6.

**4.P. 3 W.** miniature wavechange switches, long spindles, 2/6.

**B7G** moulded valveholders, per dozen, 6/-

**Collaro RC.54.** 3-speed record changers, Ivory finish. **Studio O turnover pick-up.** £9.10.0. P. & P. 3/6 extra.

**Screws.** Steel RH. 6 B.A. ½ in. per gross, 3/-; Nuts per gross, 2/-.

**Knobs.** Walnut with gold ring 1½ in. diam. 9d. each. Ditto, 1 in. diameter, 6½d. each. Ivory, ribbed 1½ in. diam., 6½d. each.

All 1st grade guaranteed valves available at competitive prices. Examples: EL84, 10/-; ECC83, 9/-; EFB6, 11/6; GZ34, 10/-; EY51, 11/-.

Postage & Packing extra. C.O.D. extra. Stamp For Lists.

**OLIVERS**

55, HAVELOCK ROAD, TORQUAY, DEVON.

## RECEIVERS &amp; COMPONENTS

**MAKING YOUR OWN?** Telescopes, Enlargers, Projectors, or, in fact, anything using lenses. Then get our booklets "How to use Ex-Gov. Lenses & Prisms," price 2/6 ea. Comprehensive lists of optical, radio and scientific equipment free for s.a.e. H. W. ENGLISH, Rayleigh Rd., Hutton, Brentwood, Essex.

**AMERICAN RADIO** Plans and Devices. Now available. Hundreds of new and startling devices you can make. Only designs of this type available in UK. Receivers, walkie-talkies, amplifiers, recorders, magic eye alarms, etc., etc. Full lists, data, illustrations. Free for stamp. Send to-day.—A.P.S. (PW), Sedgford, King's Lynn.

**MIDDLESBROUGH.** Largest stocks on N. East coast. Radio, TV components, P.M. Kits, Gram Cabinets, Tape Decks, Leak Amplifiers, Valves, etc. Callers only. PALMERS, 106, Newport Road. (Phone: 3096.)

**OSMOR** would like you to have Free Practical Wiring Diagrams of the latest published circuits with full lists of components required. Send 7d. (stamps) to **OSMOR RADIO PRODUCTS LTD.**, 418, Brighton Rd., Stn. Croydon. (Croydon 5148.) (See advert., page 384.)

**THE HIWAYMAN.** A new super Portable Radio for the home constructor: all-dry 4-valve superhet with Ferrite rod aerial; easy wiring diagrams and instructions, 1/6 (post 3d.). **RADIO EXPERIMENTAL PRODUCTS LTD.**, 33, Much Park St., Coventry.

**T/V IN PERFECT WORKING ORDER** from £14. carriage paid: all makes; many sets suitable use anywhere. Impossible to show complete stocks here. Send s.a.e. for lists of latest bargains. 10in. Marconi £14, 9in. Ekco £15, 12in. Ekco £22/10/-, 12in. Ferguson £24. THIS IS A GENUINE OFFER — NOT A "CATCH." 100's SOLD EVERY WEEK. Callers welcomed. **HIGH STREET RADIO**, 284-6, High St., Croydon, Surrey. (Phone: CROydon 9015.)

**AMERICAN MAGAZINES.** One year's "Audio," 35/-; "High Fidelity," 50/-, Specimens 4/- and 5/-, respectively. Full list from **WILLEN LTD.** (Dept. 40), 9, Drapers' Gardens, London, E.C.2.

**SERVICE SHEETS, T.V. and Radio** over 2,000 models, sale or hire; Valves and Components. S.A.E. with enquiries. **W. J. GILBERT**, 24, Frithville Gardens, London, W.12.

**SEND TO-DAY** for our stock list of T.V. and Radio Bargains. C.R.T.s. Valves, Speakers and all Components. We are the cheapest people in the trade. All goods sold by us are guaranteed. **VIDEO ELECTRONICS (LONDON) LTD.**, Dept. P.W., 16/22, Bacon Street, London, E.1.

**FM-KIT SETS,** Type P4. combines med. wave and power supply with push-pull output, price £19. Type PA for FM only, £5. Completed receivers: A £7/10/-, P4 £23. Kits are aligned for you. Guaranteed valves and components. Demonstrations at Marlborough Yard, Archway, N.19.

**TELEVISION,** 9in. Models, £6/10/-; 12in. Models, £15; all makes working; carriage paid. **TOMLINS**, 127, Brockley Rise, Forest Hill, S.E.23.

**RATES:** 5/6 per line or part thereof, average five words to line, minimum 2 lines. Box No. 1/- extra. Advertisements must be prepaid and addressed to Advertisement Manager, "Practical Wireless," Tower House, Southampton St., Strand, London, W.C.2.

**ELECTROLYTICS,** capacity, voltage, size, type of mounting, price post paid. 1,000 + 1,000, 6v, 1 x 3, clip. 3/3; 1,000 + 2,000, 6v, 1 x 3, 3/9; 100, 12v, 1/2 x 1 1/2, tag, 1/8; 500, 12v, 1/2 x 1 1/2, W/E, 2/-; 2,000, 12v, 1 1/2 x 2, W/E, 3/6; 10, 25v, 1/2 x 1 1/2, W/E, 1/3; 25, 25v, 1/2 x 1 1/2, W/E, 1/3; 50, 25v, 1/2 x 1 1/2, W/E, 1/9; 100, 25v, 1/2 x 1 1/2, W/E, 2/-; 1,000, 25v, 1 x 3, clip, 4/-; 3,000, 25v, 1 1/2 x 5/6; 5,000, 25v, 1 1/2 x 4 1/2, clip, 6/6; 500, 50v, 1 x 3, clip, 3/8; 2,500, 50v, 1 1/2 x 4 1/2, clip, 6/6; 5, 150v, 1/2 x 1 1/2, W/E, 1/3; 8, 150v, 1/2 x 1 1/2, tag, 1/3; 40 + 40, 1 x 2, clip, 2/9; 200, 250v, 1 1/2 x 3, clip, 3/6; 100, 275/350v, 1 1/2 x 3, clip, 3/-; 16 + 16, 275v, 1 x 2, clip, 3/-; 32 + 32 + 8, 1 1/2 x 2, clip, 4/3; 16 + 8 + 4, 1 x 2, lug, 3/-; 200 + 250 + 250, 1.275v, 2 x 4 1/2, clip, 8/6; 60 + 250, 275/350v, 1 1/2 x 4 1/2, clip, 6/3; 16 + 16 + 8, 350/425v, 1 1/2 x 2, lug, 4/3; 32 + 32 + 8, 350/425v, 1 1/2 x 3, clip, 5/-; 16 + 16, 350v, 1 x 2, clip, 3/8; 32 + 32, 350v, 1 1/2 x 2, clip, 4/-; 2, 350v, 1/2 x 2, tag, 1/-; 100, 350/425v, 1 1/2 x 3, clip, 4/-; 50 + 50, 350/425v, 1 1/2 x 3, clip, 4/6; 100 + 200, 350v, 1 1/2 x 4 1/2, clip, 7/6; 8, 450v, 1 x 2, clip, 1/9; 20 + 10, 450v, 1 x 3, clip, 4/-; 8 + 8, 500v, 1 1/2 x 2, clip, 4/-; Photoflash Types, 1,000 mf, 200v, 1 1/2 x 4 1/2, clip, 12/6; 1,500 mf, 275v, 2 1/2 x 4 1/2, clip, 19/6; all all cans, some with sleeves, all voltages wkg. surge where marked, new stock, guaranteed. Television Chassis, cadmium plated steel, size 13 x 13 x 2 1/2in., complete with 13 valveholders (9-B9A Pax, 1-B9A Cer., 2-B7G Cer., 1-Int. Oct. Imp.), 20 various tag strips, cut away for metal rec., line trans., etc., 9/11 each, post paid; front and rear tube mounts to fit above chassis, 3/- pair, post paid. P.M. focus Magnets, wide angle, tetrode tube, fully adjustable, 9/11, post paid. Scanning Coils, wide angle, with mounting lugs, 19/6, post paid. Vision I.F.s (2nd, 3rd and 4th), freq. 34 mc/s, slug tuned, size 13/16 x 13/16 x 2 1/2in. can, set of 3, 5/6, post paid. Mains Trans. 340-220-0, 220-340v, 120mA, 4v 6.5A, 4v 5A, 4v 1.5A, 2v 150A, 4v 6.5A, Pri. 0-205-225-245v, 30/-, postage paid. Mains trans. 250-0-250v, 120mA, 6.3v 2.5 A, 6.3v 0.6A, Pri. 0-110-125-150-205-225-245v, 17/-, post paid. **RADIO CLEARANCE LIMITED**, 27, Tottenham Court Road, London, W.1. (Telephone: Museum 9188.)

**SUPER-TONIC SUN-RAY LAMPS.** Ultra-Violet Infra-Red combined. Superb therapeutic quality, controlled output, automatic exposure. All mains. Listed £7/10/-; our price 80/-, S.A.E. illustrated brochure. Dept. 14, **SCIENTIFIC PRODUCTS**, Cleveleys, Lancs.

**B.S.R. Monarch** 3-speed Autochange Units, new in maker's sealed carton guarantee, complete with instructions, template, suspension springs, £9/15/-; carriage paid; immediate delivery. **TOMLINS**, 127, Brockley Rise, Forest Hill, S.E.23.

**ENGRAVING.**—Amateurs and trade surplus can be undertaken by getting in touch with A. G. ENGRAVING, now at 292, Earlsfield Rd., London, S.W.18. (BAT 9897.) (Engravers to well-known makers of Electronic Equipment used by the Aircraft Industry, A.W.R.E., etc.)

**RADIO UNLIMITED** offer, new, boxed Valves, 12K7, 12Q7, 352A, EL32, 6S17, 5Y3, 5U4, 1T4, 1S5, 1R5, 354, 3V4, 6BE6, 6BW6, 6SL7, 6SN7, 6X5, 6F6, ML6, all at 7/3 each. 1L4, 3A4, 8D2, 9D2, EF36, SP61, AP12, 3/6 each. ECL83, EF80, PCF80, PCC84, ECH42, EL84, EF86, PCL83, PL83, PY81, PY82, all at 10/6 each. Speakers, P.M., 2-3 ohms., 6in. 15/6; 8in. 16/6; 12in. 27/6. 12in., 15 ohms., £4/19/6. New Continental Multi-meter, list £6, offered at £5/2/6. Television band, 3 Converter Kits, c/plate with coils and valves, 42/6. Three-speed Gram., with 1/weight pick-up, 90/-. Four-speed A/change Gram. Units, £7/17/6. Two-wave T.r.f. Receiver, c/plate kit, incl. cabinet, 95/-. Three-stage Amplifier, AC or Uni., kit, 49/6; wired, 59/6. Stamp please new bargain list. **RADIO UNLIMITED**, Elm Road, Heston, E.11. (Posta. 1, 50, 11, London, E.17. (Phone: LAR 6377.)

**METAL RECTIFIERS,** 3/9, 250v, 100ma. tested, guaranteed, post 1/3; 8in. P.M. Speakers, 8/9, std., 2-5 ohms. guaranteed, post 1/9; O.P. Transformers, 1/3, std., 2-5 ohms, guaranteed, post 9d.; Receiver, No. 71, 6/9, X.W.D., works V.H.F., free drawings, less valves, post 1/9; Transmitter, No. 50, 6/9, V.H.F. coils, tuning coils, resist., etc., free drawing, less valves, post 1/9; Amplifier, 165, 5/9, trans. resist., free drawing, post 1/9. **DUKE & CO.**, 621, Romford Road, London, E.12. (GRA 6677.)

**SEVERAL EARLY MODELS** 9in. Television, complete and mostly working, £5/5/- each; carriage paid. **TOMLINS**, 127, Brockley Rise, Forest Hill, S.E.23. (FOR 5497.)

**METERS OUTPUT POWER:** Oscillographs, Oscillator beat frequency; Avo types; Line Testers; TMS No. 1 and TDMS; Wireless Set 62. **GILLILLAN**, 7, High Street, Worthing. (Tel.: Worthing 8719.)

**RAD-GRAM. CABINETS,** slight reject, £6/10/-, £9/15/-, £12/10/-, 9-5-30 weekdays, also Sunday mornings. **RESNICK**, 40, Redchurch St., London, E.2. (Bis 1758.)

**GUARANTEED TELEVISION,** 12-in. moc's, first-class picture, 5-channel, £30 each; carriage paid. **THE GRAMOPHONE SHOP**, 19-21, Brockley Rise, Forest Hill, S.E.23.

**LOUDSPEAKERS** repaired promptly. **MODEL LOUDSPEAKER SERVICE**, Bullingdon Rd., Oxford.

## SITUATIONS VACANT

**RADIO MECHANICS** wanted by large organisation for overseas duties. Tours abroad up to 2 years. Candidates must be skilled men with good knowledge radio theory, single, medically fit and prepared to work anywhere in the world. Basic U.K. salary £500 after training. Overseas salary £75 per month plus a/c found. Write Box P.W.277, c/o 191, Gresham House, E.C.2.

**ALL DISTRICTS.**—Television Technicians as Technical Agents. Write: **TELEPATROL LTD.**, West St, Epsom, Surrey.

**PRACTICAL ENGINEER** with workshop experience required for the construction and service of specialised sound equipment. Apply **STAGE-SOUND (LONDON) LTD.**, 16, Gerrard St., W.1.

**BOOKS**

**I.P.R.E. TECHNICAL PUBLICATIONS.** 6,500 Alignment Peaks for Super-heterodynes 5/9, post free. Data for constructing TV Aerial Strength Meter. 7/6. Sample copy. The Practical Radio Engineer. quarterly publication of the Institute. 2/-; membership and examination data. 1/-; Secretary, I.P.R.E., 20, Fairfield Rd., London, N.8.

**FOR SALE**

**FOR SALE.** 4 No. "Trolley Phones" with spare Speakers and Microphones; 1 No. Gramplan M/S Type Amplifier, c/w Speakers and Microphones; 3 No. "Pyc" Type PTC 703 2-way Radios, 50 mile range. Enquiries to: RICHARD COSTAIN LTD., Kingie Camp, Tomdoun, Invergardry, Inverness-shire. (Telephone: Tomdoun 2156/6.)

**VALVES**

**ALL TYPES** of new radio valves wanted, small or large quantities; cash payments. R. H. S. LTD. (W), 155, Swan Arcade, Bradford, 1.

**WANTED.** Valves, EY51, ECL80, K761, 6U4GT, PL81, 35Z4, etc., etc., prompt cash. WM. CARVIS LTD., 103, North Street, Leeds, 7.

**FREE VALVES.** new. EF50, 6J6, SP61, 6AG5, EB34, with each 5/- parcel, new eqpt., pots, v/holders, etc. State valve preferred. BATES, 1, Queen's Circus, Cheltenham.

**ALL TYPES** of Valves required for cash. State quantity and condition. RADIO FACILITIES LTD., 38, Chalcut Road, N.W.1. (PRImrose 9090.)

**EDUCATIONAL**

**CITY AND GUILDS** (Electrical, etc.) on "no pass—no fee" terms. Over 95% successes. For full details of modern courses in all branches of Electrical Technology send for our 144-page handbook—free and post free. B.I.E.T. (Dept. 242A), 29, Wright's Lane, London, W.8.

**MERCHANT NAVY** Wireless School, Overseas House, Brooks' Bar, M/cr 16.

**THE INSTITUTE** of Practical Radio Engineers Home Study Courses are suitable coaching text for I.P.R.E. and other qualifying examinations. Fees are moderate. Syllabus of seven modern courses post free from SECRETARY, I.P.R.E., 20, Fairfield Road, London, N.8.

**FREE!** Brochure giving details of Home Study Training in Radio, Television, and all branches of Electronics. Courses for the Hobby Enthusiast or for those aiming at the A.M.Brit.I.R.E., City and Guilds, R.T.E.B., and other Professional examinations. Train with the college operated by Britain's largest Electronics organisation. Moderate fees. Write to E.M.I. INSTITUTES, Dept. PW28, London, W.4.

**BUILD YOUR OWN T/V** and learn about its operation, maintenance and servicing. Qualified engineertutor available whilst you are learning and building. Free Brochure from E.M.I. INSTITUTES, Dept. PW58, London, W.4. (Associated with H.M.V.)

**THERE IS** a national shortage of Mercantile Radio Officers. Why not make Communications your career? You can be assured of a sea-going appointment after qualifying at THE SCHOOL OF MARINE RADIO AND RADAR (A.S.T.), Hamble, Southampton. For details apply Commandant, quoting A.12.

**T/V AND RADIO.**—A.M.Brit.I.R.E., City and Guilds, R.T.E.B. Cert., etc., on "no pass—no fee" terms. Over 95% successes. Details of exams, and home training courses in all branches of radio and T/V; write for 144-page handbook free. B.I.E.T. (Dept. 242G), 29, Wright's Lane, London, W.8.

**A.M.I.Mech.E., A.M.Brit.I.R.E., City and Guilds,** etc., on "no pass—no fee" terms; over 95% successes. For details of exams, and courses in all branches of engineering, building, etc., write for 144-page handbook, free. B.I.E.T. (Dept. 242B), 29, Wright's Lane, London, W.8.

**WIRELESS.** See the World as a Radio Officer in the Merchant Navy: short training period; low fees; scholarships, etc., available. Boarding and Day students. Stamp for prospectus. WIRELESS COLLEGE, Colwyn Bay.

**WIRELESS.**—Day and Evening Class instruction for P.M.G. Certificate of Proficiency and Amateur Wireless Licence. Morse instruction only if required, also postal courses. Apply BST, LTD., 179, Clapham Rd., London, S.W.9.

**THE WIRELESS SCHOOL.** Day, Evening and "Radiocerts" Postal Courses; s.a.e. for prospectus. THE DIRECTOR, 21, Manor Gardens, London, N.7.

**VACANCIES FOR SKILLED CRAFTSMEN IN GOVERNMENT SERVICE AT CHELTENHAM**

Experienced in one or more of the following:

1. Instrument Makers with fitting and machine shop experience in light engineering.
2. Maintenance of radio communication receivers.
3. Sub-assembly lay-out, wiring and testing of radio type chassis.
4. Cabling, wiring and adjustment of telephone type equipment.
5. Maintenance of teleprinters or cypher machines and associated telegraph equipment.
6. Fault finding in, and maintenance of, electronic apparatus.

**BASIC PAY:** £8 11s. 4d. plus up to £2 10s. merit pay, assessed at interview and based on ability and experience.

Opportunities for permanent and pensionable posts.

5-day week—good working conditions—single accommodation available.

Apply to: Personnel Officer, G.C.H.Q. (FOREIGN OFFICE),

53, Clarence Street, Cheltenham.

**TELEVISION**

The advance of Radio Technique will offer unlimited opportunities of high pay and secure posts for those Radio Engineers who have had the foresight to become technically qualified. How you can do this quickly and easily in your spare time is fully explained in our unique handbook.

Full details are given of A.M.Brit.I.R.E., City & Guilds Exams., and particulars of up-to-date courses in Wireless Engineering, Radio Servicing, Short Waves, Television, Mathematics, etc., etc. We guarantee "NO PASS—NO FEE." Prepare for to-morrow's opportunities and future competition by sending for this very informative 144-page guide NOW—FREE and without obligation.

**BRITISH INSTITUTE OF ENGINEERING TECHNOLOGY** (Dept. 242), COLLEGE HOUSE, 28-31, Wright's Lane, Kensington, W.8

**"UNIVERSAL" SWITCH And \* CONTACT CLEANER**

Purest Cleaner known

Removes tarnish, dirt, grease. Burnishes and lubricates. Half-pint 4/9d., post free.

**A. BUCKLEY WHEATCROFT, PURLWELL LANE, BATLEY, YORKS.**

**RADIO VALVE SUPPLY**

GLAZEBCURY, Nr. MANCHESTER

**VALVES GUARANTEED**

6SN7	6-6V6	6/61524	8-RT0	4-4
6SL7	6/68L6	9/1-EP50	4-12A U7	8-
6CB	6/6E33	6/EF90	4-SPB1	2-
6F6	6/6EY91	6/1-EC180 10/1	9/001	4/6
6C4	6/6EL91	6/1-PL81	9/6-KT33C	9/6
6SH7	5/1-EAC91	8/6-PY81	10/1-813	45-

Postage 6d.

**PYE TELECOMMUNICATIONS LTD.**

Haverhill, Suffolk

invite applications for the position of

**CHIEF STOREKEEPER**

Applicants should have had several years storekeeping experience, preferably in the Radio Industry. Possess drive and initiative and the ability to competently control staff.

**ACCOMMODATION**

will be available upon satisfactory completion of a short probationary period.

Applications, giving full details should be addressed to the

PERSONNEL MANAGER quoting Reference C.H.F.

**ASTRAL RADIO PRODUCTS**

"HOME RADIO," 32 page illustrated booklet. Simple wiring instructions for Crystal Set, 1, 2, 3 Valves, 2/-, post 3d. TRF COILS, Specified for 'Bedside Push-button 4', 'All Dry 3 Band, 3', 'Push-button 4', etc., 8/6 pr., post 6d. Push-button Unit with modification data 7/-. DUAL WAVE HIF Coil. Specified for 'Summer All Dry Portable', 'Modern 1 Valve', 'Modern 2 Valve', 'B 7 G Battery Miniature', etc., 4/3, post 3d. IFT'S Miniature, 1" x 1 1/2" x 2 1/2" in cans. Extra high 'Q'. Special offer, 8/6 pr., post 6d. K COILS, 'A.C. B' pass 3, 3/3 each, post 6d. FRAME AERIALS, M.W., 5/-, post 4d. H.F. Choke (Osmer Q.C.11) 4/-, post 4d. Crystal Set Coils, L. & M.W., 2/6, post 3d. 82, Centurion Road, Brighton

**F M and HI-FI Components**

DENCO F.M. TUNER circuits 1s. 6d.  
RADIO CONST'N. F.M. " 2s. 0d.  
MULLARD AMPLIFIERS " 3s. 6d.  
OSRAM 912 PLUJ " 4s. 0d.

Separate price lists available on request to

**J. T. FILMER MAYPOLE ESTATE, BEXLEY, KENT.**

Tel. Bexleyheath 7267.

*Solder with*



**LITE SOLDER**  
REG. TRADE MARK

"PERMATIP"  
AND  
"PERMABIT"  
INSTRUMENTS  
FOR  
GREATER  
SOLDERING  
EFFICIENCY

The soldering bit which maintains its face indefinitely without attention. 25 models available for mains or low voltage supply. Bit sizes 3/32 to 3/8 inch. Full details in booklet S.P.10 from sole manufacturers:—

**LIGHT SOLDERING DEVELOPMENTS LTD.,**  
106, GEORGE STREET, CROYDON, SURREY. Tel. CR0Ydon 8589.

**CABINETS & HI-FI EQUIPMENT**

We can supply any Cabinet to your own specification

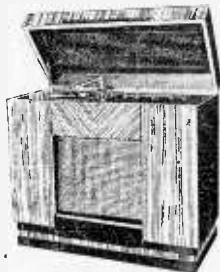

The Cabinet illustrated can be supplied in any shade of walnut, oak or mahogany for **£19.19.0.**

We can supply and fit into any cabinet all the latest hi-fi amplifiers, tuners, transcription units, record changers, speakers, etc.

Send for free illustrated catalogue of cabinets, chassis, autochangers and speakers, etc. H.P. can be arranged.

**LEWIS RADIO COMPANY**  
120, GREEN LANES,  
PALMERS GREEN, LONDON, N.13  
BOWes Park 6064

**BROOKS (RADIO)**

4 Charles Street, Morecambe, Lancs.

- BAND 3 AERIALS**
- Chimney lashed ... .. 63/6
  - Wall mounting ... .. 41/6
  - Cranked arm, 4/6 extra.
  - Mast attachment ... .. 39/6
  - Loft type ... .. 33/6
  - Prices quoted for 3-element types.
  - Extra elements 6.- per element.

- BAND 2 AERIALS.**  
Prices upon application.
- Cross-over Units ... .. 11/6
  - CONVERTERS** (Band 3. all Channel) ... .. 10 gns.
  - Air-spaced Co-ax. 10 1/4 yd.
  - Co-ax. Plugs (solderless) 1/3 each.
- All valves previously advertised still available.

**ELECTRONIC ORGAN ENTHUSIASTS**  
BUILD THE  
"LECTROCHORD"

The full-size electronic organ in kit form. For as little as £5 you can start building an instrument you will be proud to own. Everything supplied down to the last nut and bolt.

Send S.A.E. for detailed specification to:—

**"LECTROCHORD"**  
123, Uxbridge Road,  
Rickmansworth, Herts.

**T.C.R.C.**  
POSTAL COURSES  
**RADIO TELEVISION MATHEMATICS**  
Backed by 23 years' success  
Write for free booklet  
**T/C RADIO COLLEGE**  
DUART HOUSE, ASHLEY ROAD,  
NEW MILTON, HANTS.

**Fidelia**  
HAND BUILT RADIO UNITS



**THE FIDELIA MAJOR 10**

- Fidelia AM/FM models give reception of V.H.F. high quality transmissions plus normal wavebands. Major AM/FM 12 valves. £44. De-Luxe AM/FM 11 valves. £33/12/-. F.M. Tuner, £14/3-. Data Sheets free.
- Electro Acoustic Developments, 2, Amburst Road, Telscombe Cliffs, Sussex.

**1-Finger Pianists**

Build your own electronic keyboard and play everything! Send for free leaflet. Guitar, cello, flute and trumpet are all easy. Write now. . .

**C & S, 10 Duke St., Darlington, Co. Durham**

**RADIO AND TELEVISION COMPONENTS**  
All parts in stock for:  
**Viewmaster, Soundmaster, Teleking, etc.**  
Easy Terms available.  
2id. stamp (only) for Catalogue.  
**JAMES H. MARTIN & CO.,**  
1 INSTITUTEWAITE, NEWBY BRIDGE  
ULVERSTON, LANCs.

**VIEW MASTER BAND III CONVERSION**

We can supply complete kits from stock for the converter described in "Practical Television".

- Complete converter kit with new BVA Valves **£9.4.0.** (Credit terms: Deposit £1.6.9 and 7 monthly payments of £1.6.9.)
- Complete converter kit with surplus valves. **£8.2.0.** (Credit Terms: Deposit £1.4.0 and 7 monthly payments of £1.4.0.)

Kit for conversion of the View Master Sound/Vision chassis, **£2.0.0.**

We can supply separate components and our fully detailed list is available on request.

**WATTS RADIO**  
8 Apple Market, Kingston-on-Thames, SURREY  
Telephone: KINGston 4099.

**NEW BOOKS**

- Radio Amateur's Handbook 1956, by A.R.R.L. 30 -. Postage 1/3.
- High-Fidelity: The Why and How for Amateurs, by G. A. Briggs. 12/6. Postage 1/.
- Transistors and Crystal Diodes, by B. Etridge. 5 -. Postage 4d.
- Radio Control of Models, by Sommerhoff. 5 -. Postage 4d.
- Radio Servicing Instruments, by Bradley. 4/6. Postage 4d.
- Practical T.V. Aerial Manual for Bands I and III, by Laidlaw. 4/6. Postage 4d.
- Beginner's Guide to Radio, by Camm. 7/6. Postage 6d.

Please write or call for lists.

**UNIVERSAL BOOK CO.**  
12, Little Newport Street, London, W.C.2  
(adjoining Lisle Street)





**RECORD PLAYERS! AMPLIFIED PLAYERS! GRAM MOTORS! AUTOCHANGERS! CABINETS!**

Many to be cleared at less than half price. 3-speed Gram. Motors by well-known manufacturer. 100/125, 200/250 AC mains. 31, 45, 78 r.p.m. and neutral by selector switch. 7 guinea value! Our price £3.10.0.

3-speed Record Players, fitted Acos turn-over HGP 59 pick-ups, with twin sapphire styl. Rexine case with lid, fitted clasps and handle. Worth 10 gns.! Our price £7.15.6.

Carriage, Packing & Insurance 5/6. Send stamp for complete bargain lists.

**RONALD WILSON & CO.**  
(Dept. P.W.) 12, Bridge St., Worcester

**STAN WILLETTS**

43, Spon Lane, West Bromwich, Staffs. TEL.: WES 2392.

**SPECIAL OFFER. "6" VALVES** for 12.6. 6K7G, EF50, EF39, EL32, TT11, SP61. ANY 5 VALVES FOR 9.6.

SP61, TT11, ATP4, EA50, 6B8G, 6SL7, 6K7G, 3.9, 6K7M, 4.6, 6J5M, 4.6, 6AQ5, 7A05, 16.9, 6X4, 5.6, 7C5, 7.6, 10F1, 9.6, 12AU7, 7.6, 12BE6, 5.6, DH76 (2Q7), 7.6, W76 (12K7), 7.6, U76 (92Z4), 7.6, EB33, 7.6, EF39, 5.6, EF36, 3.9, EF3A, 9.6, EF80, 8.6, EF50, 3.9, EL84, 9.9, PCL83, 9.6, PY81, 9.6, UB4C1, 8.6, UCH42, 9.6, Y63, 5.6, P. & P. extra.

**RI155B COMMUNICATION RECEIVER** complete with valves, £5.18.0. P. & P. 10/-.

**AS ABOVE BUT FULLY FIT.** £3.10.0. P. & P. 10/-.

**GERMANIUM CRYSTAL DIODES.** G.E.C. 1. - each, 9.6 doz. P. & P. 3d.

**RECORDING TAPE.** 1,200 ft. on plastic spool, 14.6. P. & P. 1/-.

**NEW VALVES WANTED.**

**SPARKS' DATA SHEETS**

Constructional Sheets of Guaranteed and Tested Radio Designs.

Battery operated:-

- LO 25. 1-V. M.L. Waves. Fine Phone Sigs.
- LO 23. 1-V. Med Wave Portable.
- LO 31. 2-V. M.L. Portable Fine Range.
- LO 30. 2-V. M.L. Most Widely Praised.
- LO 35. 4-V. M.L. T.R.F. Range and Power.
- LO 27. 4-V. All-wave S.Het. Comp. Act.
- D.X.2. 2-V. Short-waver. Really Good.

Data Sheets, etc. 3 - each, post Free.

**TO ALL D.X.2 OPERATORS**

Convert your D.X.2 to a 3-V. T.R.F. model with a specially designed add-on H.F. Unit increasing Range and Selectivity. D Sheet 3 - Post Free.

MANY OTHER DESIGNS AVAILABLE. SEND 2jd. STAMP FOR DETAILED LIST. All Components & Chassis Available.

**L. ORMOND SPARKS (P),**  
Valley Road, Corfe Castle, Dorset

**TELETRON FERRITE ROD AERIALS**

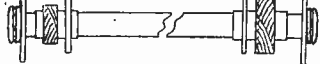

Wound on high permeability Ferroxcube rod. MW.8.9. Dual wave, 12.9.

Supersonic Tape Osc. coil. Type SSO. 15/-.

Eliminates 50 cps. Hum by supplying 6.3 v. at 30 Hz to pre-amp. heater and 22 v. 1A. BAND III converter coils. 15/- and 17.6.

Wiring diagram. circuit, etc. 3d. each. Type HAX selective crystal diode coil for MW. 3/-.

HAX.L.36. Dual TRF coils, matched pairs 7/-.

Transistor coils. I.F.T.s, etc. Available from leading stockists. Stamp for complete list and circuits.

**THE TELETRON CO. LTD.,**  
266, Nightingale Rd., London, N.9  
HOW 2527

**TRANSFORMERS FOR WELL-KNOWN AMPLIFIERS**

Mullard 3W, MT/3m (mains)	35/-
OT/3 (output)	21/-
5-10 OT/6 (low load)	45/-
OT/8 (high load)	45/-
OT/ML (U.L. output) ...	45/-
MT/5/10 (mains)	36/-
MT/MU (mains for 5/10 and feeder unit)...	42/-
Osram 912 MT/912 (mains)	40/6
OT/912 (output)	45/-

The above are of ELSTONE Make. Trade supplied:

**KENDALL & MOUSLEY LTD.**

18, Melville Road, Birmingham, 16

**B28 (CR100),** all mains or batt. receiver. 60 kc/s to 30 mc/s in 6 bands. Crystal filter. B.F.O. Ready for immediate use, needs only speaker or phones. Excellent condition. £17/10/0. C. & P. 20/- (U.K. only).

**Outstanding Bargain.** Parmeko 15 watt loudhailing type amplifiers for 12 volt D.C. supply. Valve line up EF36, ECC31, 2 6L6. 15 ohm output. Ideal for mobile public address. £4/10/0, C. & P. 15/-.

**Pressure Type Loudspeaker Units.** 15 ohm 15 watts less horn suitable for above, 15/4, P. & P. 3/-.

**SCR522 Receivers.** 100-156 mc/s suitable for 2.5 metre conversion. Few only, £4/10/0. Transmitter section, £4/10/0.

**Handwound Time Switches.** 35-day movement by Venner. Used but excellent condition in die-cast case. Listed £20. 45/- each. P. & P. 3/-.

**Chitern Overload Trips.** 15, 30 and 50 amp., 5/6.

Money back guarantee on everything. When in Exeter call and see our large stocks.

**ELECTROSURP**  
120 Fore Street, Exeter

Phone : Exeter 56687.

**MORSE CODE Training**  
Send for the Candler BOOK OF FACTS

It gives details of All Courses which include a Special one for acquiring amateur licence. Candler System Co., Dept. S.8 52b, Abingdon Road, London, W.8 Candler System Co., Denver, Colorado, U.S.A.

**ANNAK'S BARGAINS**

RF24 with valves, 9.3 ; RF27 with valves, modulated dial, 23.3 ; 1134A Amplifier with 2 battery valves, 7.3 ; Responder W.4790A, with 5 VR65, 1 VR136, 1 VR137, 2 VR92 (less relay), store soiled, 17/-; Speech Modulator, BC456B (less dynamotor, valves, 2 top relays), 12.6 ; Speech Mod. BC456B (less dynamotor, valves, 2 top relays, Mod. transf., smooth choke), 5/-.

All carriage free. Money Back Guarantee. Free Lists.

25, ASHFIELD PLACE, OFLEY, YORKS

**Broadcast in Your Own Home**



The New Highly Sensitive Microphone incorporating a specially wound transformer designed to match any Radio or Radiogram, mains or battery. Hours of amusement at a party, good fun for all the family. Suitable for baby alarms and many other purposes. Not a toy but a guaranteed working instrument. Full instructions enclosed. Made to sell at 21/-.

**OUR PRICE 15/- POST TRADE SUPPLIED**

**E. CLAPSHAW**  
368, Alexandra Rd., Muswell Hill, London, N.10.



**PULLIN**  
SERIES 100  
TEST METER  
AC/DC 10,000 d/v  
21 RANGES  
100µA to 1000 V  
COMPLETE IN DIE CAST CASE WITH TEST LEADS CLIPS AND PAGES  
FULLY GUARANTEED

SENT POST FREE FOR £2.10.0 AND NINE FURTHER MONTHLY PAYMENTS OF £1.4.6. CASH PRICE £12.7.6.

**FRITH RADIOCRAFT LTD**  
69 71 CHURCHGATE LEICESTER PHONE 58927  
28 HIGH STREET NEWPORT PAGNELL, BUCKS PHONE 237

**H.A.C. SHORT WAVE EQUIPMENT**

Noted for over 18 years for S.W. Receivers and Kits of Quality.

Improved designs with Denco coils: One-Valve Kit, Model "C" Price, 25/- Two " " " " "E" " 50/-

All kits complete with all components, accessories, and full instructions. Before ordering call and inspect a demonstration receiver, or send stamped, addressed envelope for descriptive catalogue.

"H.A.C." SHORT-WAVE PRODUCTS (Dept. TH) 11, Old Bond Street, London, W.1.

**VALVES**  
New Tested and Guaranteed

1R5	7/6	6BA6	8/6	807	6/9
1S5	7/6	6BR7	8/6	ECH35	9/6
1T4	7/6	6K7	6/-	EF39	5/6
3V4	7/6	6K8	8/6	EE55	9/6
5Z4G	8/6	6K8C	8/-	EP80	10/-
6AM6	7/6	6V6G	7/6	EK32	8/6
6AL5	6/6	12AT7	9/-	EL83	11/-
6AT6	8/-	12AU7	9/-	KT33C	9/6

**MATCHED PAIRS.** EL84, 23/-; 6V6G and GT. 17 - 6BW6, 18/-; KT33C, 19/6; 807, 14/6 per pair.

**VOLUME CONTROLS.** small, long spd., L/S. 3/-; S.P., 4/-; D.P., 4/6. All valves.

**PAPER BLOCKS,** 4 mid., 1,000 v. wks., 2.3. P. & P. 6d.

**R. J. COOPER (G8BX)**  
32, SOUTH END, CROYDON, SURREY  
Croydon 9186

## 62AK This Month's Bargains

Don't miss this one!

### CRYSTAL HAND MICROPHONES

As illustrated, in silver hammer case with polished grille, handle and 4 feet screened lead. ONLY 21/-.



### ABSORPTION WAVEMETERS

3.00 to 35.00 Mc/s in 3 switched bands. 3.5, 7, 14, 21 and 28 Mc/s Ham bands marked on scale. Complete with indicator bulb. A MUST for any Ham Shack. ONLY 15/- each, p. & p. 1/-.

**AERIAL WIRE.** Copper, 7/25 stranded: 140ft., 10/- 70ft., 5/-; Hard Drawn 14g: 140ft., 17/-; 70ft., 8/6. P. & p. 2/-.

**GLASS INSULATORS.** 1/6 each. Small shell ditto, 4 1/2 d. each or 4/- doz, plus postage.

**CONDENSERS.** 8μF 600 v. Trop. 750 v. normal condensers. NEW, ex W.D. stock, 5/6, p. & p. 1/6.

**New TCC Type III.** 8 mfd, 1,000 v. D.C. wk'g. (List over £3). OUR PRICE 10/6, p. & p. 1/9.

## FLASH!!! EDDYSTONE 888.

New Ham Band only Receiver.

JUST OUT! Send s.a.e. for details.

No C.O.D. on orders under £1.

PLEASE PRINT YOUR NAME AND ADDRESS.  
**CHAS. H. YOUNG LTD.**

All callers  
110, Dale End,  
Birmingham 4 (CEN 1635)

Mail Orders to Dept. "P"  
102, Holloway Head,  
Birmingham 1 (MID 3254)

Train for a wonderful  
future in —

# ELECTRONICS

Train to meet the need for pioneers in this  
expanding field.

Every day the demand for the expert in electronics grows. Radio, television, radar and the whole field of industrial automation are rapidly expanding, and the trained specialist assures for himself a well-paid career in this quickly developing profession. Here is your opportunity to enter for

### 1-year course

Full-time day course in the Principles and Practice of Radio and Television. Mainly designed for the training of Radio and Television Servicing Engineers. Next course, commencing May 22nd, is already fully booked. Enrolments for following course, commencing September 11th, now being accepted.

## The E.M.I. College of Electronics

Dept. 32, 10, Pembridge Square, London, W.2.

Telephone: BAYswater 5131/2

The College associated with a world-wide electronics industry, including "His Master's Voice," Marconiphone, Columbia, etc.

## REPANCO HIGH GAIN SUPERHET COIL PACK

TYPE LMS

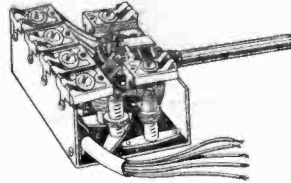

Size

2 3/4 x 2 3/4 x 1 1/2 in

Long Wave 900-2,000 m.

Medium Wave 190-550 m.

Short Wave 16-60 m. Complete with 5-valve  
Aligned before Despatch. Superhet Wiring Diagrams

Send S.A.E. for Catalogue of Complete Range of Coils.

### REPANCO I.F. TRANSFORMERS

Standard Type TCG. Size 1 1/2 in. x 1 in. x 2 1/2 in.  
13/6 pair.

Miniature Type MSE. Size 1 3/16 in. x 1 3/16 in. x 1 3/8 in.  
12/6 pair.

Both types pre-aligned 465 kc/s.

## RADIO EXPERIMENTAL PRODUCTS LTD.

33 MUCH PARK STREET, COVENTRY

Phone: 62572

# 36/-

## "You can rely on us"

LARGE STOCKISTS OF RADIO AND  
ELECTRONIC COMPONENTS

H.P. on INSTRUMENTS, "912" and  
MULLARD AMPLIFIER KITS, SOUND-  
MASTER, VIEWMASTER, Etc., Etc.

RESISTORS — STANDARD, MIDGET,  
HIGH STABILITY, PRECISION;  
TAPPED VOL. CONTROLS, Etc., Etc.

SEND FOR LIST.

Proprietary catalogues available to Manu-  
facturers' Laboratories, Education Authorities,  
etc.

## RADIO SERVICING CO.,

82, SOUTH EALING ROAD,  
LONDON, W.5.

EAL 5737

# Practical Wireless BLUEPRINT SERVICE

## PRACTICAL WIRELESS

No. of  
Blueprint

### CRYSTAL SETS

- 1/6d. each
- 1937 Crystal Receiver ... PW71\*
- The "Junior" Crystal Set ... PW94\*
- 2s. each
- Dual-Wave "Crystal Diode" ... PW95\*

### STRAIGHT SETS

Battery Operated.

- One-valve : 2s. each
- The "Pyramid" One-valver (HF Pen) ... PW93\*
- The Modern One-valver ... PW96\*
- Two-valve : 2s. each
- The Signet Two (D & LF) ... PW76\*

- 3s. each
- Modern Two-valver (two band receiver) ... PW98\*
- Three-valve : 2s. each
- Summit Three (HF Pen, D, Pen) ... PW37\*
- The "Rapide" Straight 3 (D, 2 LF (RC & Trans)) ... PW82\*
- F. J. Camm's "Sprite" Three (HF, Pen, D, Tet) ... PW87\*

- 3s. each
- The All-dry Three ... PW97\*
- Four-valve : 2s. each.
- Fury Four Super (SG, SG, D, Pen) ... PW34C\*

Mains Operated

- Two-valve : 2s. each.
- Selectone A.C. Radiogram Two (D, Pow) ... PW19\*
- Three-valve : 3s. 6d. each.
- A.C. Band-Pass 3 ... PW99\*
- Four-valve : 2s. each.
- A.C. Fury Four (SG, SG, D, Pen) ... PW20\*
- A.C. Hall-Mark (HF Pen, D, Push Pull) ... PW45\*

### SUPERHETS

- Battery Sets : 2s. each.
- F. J. Camm's 2-valve Superhet ... PW52\*
- Mains Operated : 3s. 6d. each.
- "Coronet" A.C.4 ... PW100\*
- AC/DC "Coronet" Four PW101\*

No. of  
Blueprint

### SHORT-WAVE SETS

Battery Operated.

- One-valve : 2s. each.
- Simple S.W. One-valver ... PW88\*
- Two-valve : 2s. each.
- Midget Short-wave Two (D, Pen) ... PW38A\*
- Three-valve : 2s. each.
- Experimenter's Short-wave Three (SG, D, Pow) ... PW30A\*
- The Perfect 3 (D, 2 LF (RC and Trans)) ... PW63\*
- The Band-spread S.W. Three (HF, Pen, D, Pen) ... PW68\*

### PORTABLES

- 1s. 6d.
- The "Mini-Four" A dry (4-valve superhet)

### MISCELLANEOUS

- 2s. each.
- S.W. Converter-Adapter (I valve) ... PW48A\*
- The P.W. 3-speed Autogram ... (2 sheets), 7s. 6d.\*
- The P.W. Electronic Organ (2 sheets), 7s. 6d.

### TELEVISION

- The "Argus" (6in. C.R. Tube), 2/6\*
- The "Super-Visor" (3 sheets), 7/6\*
- The "Simplex" ... 3/-\*
- The P.T. Band III Converter 1/-\*

All the following blueprints, as well as the PRACTICAL WIRELESS numbers below 94 are pre-war designs, kept in circulation for those amateurs who wish to utilise old components which they may have in their spares box. The majority of the components for these receivers are no longer stocked by retailers.

## AMATEUR WIRELESS AND WIRELESS MAGAZINE

### STRAIGHT SETS

Battery Operated.

- One-valve : 2s.
- B.B.C. Special One-valver ... AW387\*
- Mains Operated
- Two-valve : 2s. each.
- Consoclectric Two (D, Pen), A.C. ... AW403

### SPECIAL NOTE

THESE blueprints are drawn full size. The issues containing descriptions of these sets are now out of print, but an asterisk denotes that constructional details are available, free with the blueprint.

The index letters which precede the Blueprint Number indicate the periodical in which the description appears. Thus P.W. refers to PRACTICAL WIRELESS, A.W. to Amateur Wireless, W.M. to Wireless Magazine.

Send (preferably) a postal order to cover the cost of the Blueprint (stamps over 6d. unacceptable) to PRACTICAL WIRELESS, Blueprint Dept., George Newnes, Ltd., Tower House, Southampton Street, Strand, W.C.2.

No. of  
Blueprint

### SHORT-WAVE SETS

- Battery Operated
- One-valve : 2s. each.
- The "Mini-Four" A dry (4-valve superhet) ... AW429\*
- Two-valve : 2s. each.
- Ultra-short Battery Two (SG, det Pen) ... WM402\*

- Four-valve : 3s. each.
- A.W. Short Wave World-beater (HF Pen, D, RC, Trans) ... AW436\*
- Standard Four-valver Short-waver (SG, D, LF, P) ... WM383\*

Mains Operated

- Four-valve : 3s.
- Standard Four-valve A.C. Short-waver (SG, D, RC, Trans) ... WM391\*

### MISCELLANEOUS

- Enthusiast's Power Amplifier (10 Watts) (3/-) WM387\*
- Listener's 5-watt A.C. Amplifier (3/-) ... WM392\*
- De Luxe Concert A.C. Electrogram (2/-) ... WM403\*

### QUERY COUPON

This coupon is available until Aug. 6th, 1956 and must accompany all Queries, sent in accord with the notice on our "Open to Discussion" page. PRACTICAL WIRELESS, Aug., 1956.

## THE "WEYRAD" AM/FM RECEIVER

A COMPLETELY NEW DESIGN SPECIALLY DEVELOPED  
FOR THE AMATEUR CONSTRUCTOR

This publication gives full information on the Assembly and Alignment of a Four-Band Seven-valve Receiver, including All Chassis details, Circuits and Wiring Diagram.

Up-to-the-minute components and valves provide a high standard of performance (equivalent to an eight-valve circuit) and complete coverage of the sound broadcast bands, ensuring that the set will not "date" for many years.

- ★ Latest Type Mullard Valves
- ★ "Weyrad" Coil Pack, I.F. Transformers, Tuning Scale, I.F. Filter, Mains and Output Transformers
- ★ Aluminium Chassis available with all punching and bending complete
- ★ All Condensers, Resistors and other components by well-known manufacturers

FULLY ILLUSTRATED BROOKLET, PRICE 2s. 6d.

WEYMOUTH RADIO MANUFACTURING CO., LTD., CRESCENT ST.  
WEYMOUTH, DORSET



**G.E.C.**

**ALUMINISED  
C.R. TUBES**

7203A. 14"

The G.E.C. 14in. Cathode Ray Tube type 7203A has the following attractive features:—

- (1) Improved tube life and reliability.
- (2) A narrow beam angle triode gun giving:—  
(a) Uniform focus over the entire screen area.  
(b) Small spot size. (c) Freedom from astigmatism.
- (3) A high reflectance aluminium backing to the fluorescent screen giving:—  
(a) 70% increase in picture brightness. (b) High contrast daylight viewing. (c) Complete elimination of ion burn from both positive and negative ions.

Price  
**£14. 15. 0**  
P.Tax **£6. 18. 1**

THE GENERAL ELECTRIC CO. LTD    MAGNET HOUSE, KINGSWAY, LONDON W.C.2