

MAKING A 3½ INCH OSCILLOSCOPE

PRACTICAL 1/3 WIRELESS

JULY
1956

EDITOR: F.J. CAMM



THE "WEYRAD" SIGNAL GENERATOR

AN INSTRUMENT OF HIGH ACCURACY AT LOW COST



- Coverage 100 Kc/s-70 Mc/s (on fundamentals).
- Accuracy better than $\pm 2\%$ on all ranges.
- Large, clearly calibrated scale.
- Modulated or C.W. output.
- 500 c/s A.F. source.
- S.G.M.I.—A.C. mains operation. Double wound, varnish-impregnated transformer, tapped 210/225/250 volts.
- S.G.B.I.—All dry battery operated.
- All components are by well-known manufacturers ensuring maximum reliability.
- Both types in quantity production.
- Illustrated leaflet available, price 2d.

WEYMOUTH RADIO MANUFACTURING CO., LTD.
CRESCENT STREET, WEYMOUTH, DORSET

Maxi-Q "VIEW MASTER" T.V.



3 STATION TUNER AND
MODIFICATION COMPONENTS

3 STATION T.V. TUNER

These coils have been specially wound for use in the "View Master" T.C.C. Printed Circuit Commercial Television Converter, as described in the January, February and March, 1956 issues of "Practical Television." The packet contains Coils, Iron Dust Slugs, Screening Can and Screws. PRICE 30/-.

SWITCH KIT. Fine Tuner, Coil Mounting Plates, Tag Panel, Earthing Wire and Copper Foil for the 3 Station Tuner. PRICE 27/- Fine Tuner sold separately at 4/-.

Available from all reputable stockists or direct from Works. Send 1/- in stamps for GENERAL CATALOGUE covering full range of components.

MODIFICATION COILS

Coils for the Modification of the T.R.F. "View Master" into an I.F. Unit for use with the 3 Station Tuner. The packet contains all Coils complete with Iron Dust Slugs. PRICE 20/-.

DENCO (GLACTON) LTD., 357/9, OLD ROAD, GLACTON-ON-SEA, ESSEX

STOP PRESS : "MAXI-Q" F.M. TUNER UNIT assembled and valued at £9/19/6 inc. Power Pack at £3.

"OSRAM" F.M. TUNER completely assembled and valued at £30/16/0 inc.

"MULLARD 3 VALVE 3 WATT HI-FI AMPLIFIER" 16 s.w.g. Aluminium punched chassis, 10/6 each.



UNDOUBTEDLY THE BEST VALUE YET OFFERED

Stern's "fidelity" Tape Recorder

ASSEMBLED & READY FOR USE **£43**

(Plus £1.10.0 Carr. and Insurance. £1 is refunded when packing case is returned to us.)
H.P. Terms £21.10.0 deposit and 12 monthly payments of £1.19.11

!! HOME CONSTRUCTORS !!
— BUILD IT YOURSELF FOR **£40**

The Truvox Tape Deck and the Quality Amplifier are supplied tested and ready for use. The actual assembly of the Recorder is simple and only involves a few connections (a connection chart is supplied for this purpose). The items illustrated and described form the complete equipment and each are available for sale separately.

TRUVOX TAPE DECK MODEL Mk. III/TR7/u

This is Truvox's new "small" design being only 14in. x 13in. The whole instrument is built to close engineering limits resulting in the minimum of "wow" and "flutter" values. It will play the NEW PRE-RECORDED TAPES and takes all standard tapes up to 1,200ft.

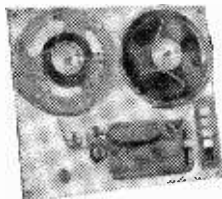

SCOTSBOY MAGNETIC RECORDING TAPE

Supplied complete with a 1,200ft. reel of Scotsboy Tape.

MODEL MIC33/1 ACOS CRYSTAL MICROPHONE

A highly sensitive Mike which accurately matches the input arrangement of the Amplifier.

MODEL TRF QUALITY AMPLIFIER

This amplifier has been expressly designed to meet the requirements of

enthusiasts for fidelity reproduction, and in particular to CORRECTLY operate the above TRUVOX DECK. It is supplied complete with a matched Elliptical 3 ohm P.M. Speaker. It incorporates an efficient Tone Control arrangement and has a Magic Eye Level Indicator (Operative on Record). It can also be used as a general purpose Amplifier for high quality reproduction of gramophone records direct from a Gram Unit.

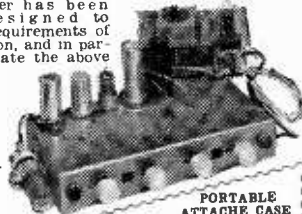

PORTABLE ATTACHE CASE

Neat, compact and attractively finished. It contains concealed pockets for Mike, Mains Lead and reel of tape.

SEND S.A.E. FOR DESCRIPTIVE LEAFLET INCLUDING PRICE DETAILS & H.P. TERMS

STERN RADIO LTD.

109 & 115, FLEET STREET, E.C.4

Tel.: FLEet 5812-3-4.

Train for a wonderful future in —

ELECTRONICS

Every day the demand for the expert in electronics grows. Radio, television, radar and the whole field of industrial automation are rapidly expanding, and the trained specialist assures for himself a well-paid career in this quickly developing profession. Here is your opportunity to enter for

4-year course in ELECTRONIC ENGINEERING

Intended for good Science sixth-formers who are capable of training into future team leaders in scientific applications. Final qualifications are B.Sc. and City and Guilds' Full Technological Certificate in Telecommunications Engineering. This course is recognised by the Institution of Electrical Engineers. At least 18 E.M.I. Scholarships are offered for the 1956 course which commences on October 2nd.

Train to meet the need for pioneers in this expanding field

3-year course in TELECOMMUNICATIONS

Entrance standard G.C.E. Ordinary level or equivalent. This course trains Assistant Development Engineers to City and Guilds' Full Technological Certificate level. Opportunities for practical attachments to E.M.I. Laboratories and Workshops are provided. Details of special Scholarship Scheme available for next course commencing September 11th.

The E.M.I. College of Electronics

Dept. 32, 10, Pembridge Square, London, W.2.

Telephone: BAYswater 5131/2.

The College associated with a world-wide electronics industry, including "His Master's Voice," Marconiphone, Columbia, etc.

R.S.C. A8 ULTRA LINEAR 12 WATT AMPLIFIER

NEW 1956 Model High-Fidelity Push-Pull Amplifier with "Built-in" Tone Control. Pre-amp stages. High sensitivity. Includes 5 valves (807 outputs). High quality sectionally wound output transformer, specially designed for Ultra Linear operation, and reliable small condensers of current manufacture. INDIVIDUAL CONTROLS FOR BASS AND TREBLE "Lift" and "Cut". Frequency response ± 3 db. 30-30,000 c/c. Six negative feedback loops. Hum level 7 db. down. ONLY 70 millivolts INPUT required for FULL OUTPUT. Suitable for use with all makes and types of pick-ups and practically all microphones. Comparable with the very best designs. For STANDARD OR LONG PLAYING RECORDS. For MUSICAL INSTRUMENTS such as STRING BASS, GUITARS, etc. **OUTPUT SOCKET** with plug provides 200 v., 20 mA., and 6.3 v., 1.5 a. For supply of a RADIO FEEDER UNIT. Size approx. 12.9-7in. For A.C. mains 200-250 v., 50 c/c.s. Outputs for 3 and 15 ohm speakers. Kit is complete to last nut. Chassis is fully punched. Full instructions and point-to-point wiring diagrams supplied. Unapproachable value at £7 15-, or factory built 45.- extra. Carriage 10-. If required louvred metal cover with 2

£7-15-0

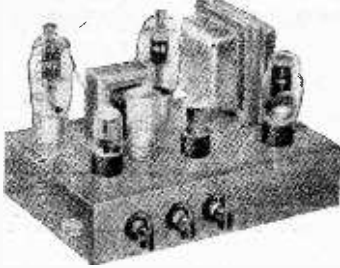

carrying handles can be supplied for 17s. Additional input socket with associate vol. Control so that two different inputs such as Gram and "Mike" or Tape and Radio can be mixed, can be provided for 13.- extra. H.P. TERMS on assembled two input model. DEPOSIT 25/6 and nine monthly payments 25/4. HIGH FIDELITY MICROPHONES and SPEAKERS in stock. Keen cash prices or H.P. terms if supplied with amplifier.

R.S.C. 4.5 WATT A5 HIGH-GAIN AMPLIFIER

A highly sensitive 4-valve quality amplifier for the home, small club, etc. Only 50 millivolts input is required for full output so that it is suitable for use with the latest high-fidelity pick-up heads, in addition to all other types of pick-ups and practically all mikes. Separate Bass and Treble Controls are provided. These give full long-playing record equalisation. Hum level is negligible being 71 db. down. 15 db. of negative feedback is used. H.T. of 300 v., 25 mA., and L.T. of 6.3 v., 1.5 a. is available for the supply of a Radio Feeder Unit, or Tape Deck preamplifier. For A.C. mains input of 200-250 v., 50 c/c.s. Chassis is not alive. Kit is complete in every detail and includes fully punched chassis (with baseplate) with green crackle finish, and point-to-point wiring diagrams and instructions. Exceptional value at only 24/15-, or assembled ready for use 25/- extra, plus 3/6 carr.



R.S.C. TA1 HIGH QUALITY TAPE DECK AMPLIFIER. For ALL Tape Decks with High Impedance, Playback and Erase Heads, such as Lane, Truvox etc. Adjustment Ready for type of deck made by Use ONLY alteration of a resistor. For A.C. Mains 230-250 v., 50 c/c.s. Positive compensated identification of recording level by Magic Eye. Recording facilities for 15, 7 1/2 or 3 1/2 in. per sec. Automatic equalisation at the turn of a knob. Linear frequency response of ± 3 db., 50-11,000 c.p.s. Negative feedback equalisation. Minimum distortion reproduction. Sensitivity is 15 millivolts so that any kind of crystal microphone is suitable. Only 2 millivolts minimum output required from recording head. Provision is made for feeding a P.A. amplifier. Unit can also be used as a gram-amplifier requiring input of 0.75v. R.M.S. Carriage 7/6. Illustrated leaflet 6d.

11 GNS.

PICK-UPS. Collaro high-fidelity low impedance magnetic type, with matching transformer. Only 25/6. Brand New.

R.S.C. 30 WATT ULTRA LINEAR HIGH-FIDELITY AMPLIFIER A6

A highly sensitive Push-Pull, high output unit with self-contained Pre-amp., Tone Control Stages. Certified performance figures compare equally with most expensive amplifiers available. Hum level 70 db. down. Frequency response ± 3 db. 30-30,000 c/c.s. A specially designed sectionally wound ultra linear output transformer is used with 807 output valves. All components are chosen for reliability. Six valves are used, and separate Bass and Treble controls. Minimum input required for full output is only 30 millivolts so that ANY KIND OF MICROPHONE OR PICK-UP IS SUITABLE. The unit is designed for CLUBS, SCHOOLS, THEATRES, HALLS OF BASS AND TREBLE CONTROL. For use with Electronic ORGAN, GUITAR, STRING BASS, etc. For standard or long-playing records. OUTPUT SOCKET PROVIDES L.T. and H.T. for a RADIO FEEDER UNIT. Amplifier operates on 200-250 v., 50 c/c.s. A.C. Mains and has outputs for 3 and 15 ohm speakers. Complete kit of parts with fully punched chassis and point-to-point wiring diagrams and instructions.

9 GNS.

If required cover as above, **ONLY** can be supplied for 17/6. An extra input with associated vol. control so that two separate inputs such as Gram and Mike can be mixed, can be provided for 13.- extra. The amplifier can be supplied, factory built with 12 months' guarantee for 50.- extra. H.P. TERMS for assembled two input model: DEPOSIT 28/6 and 12 monthly payments of 21/-.

P.M. SPEAKERS. All 2-3 ohms, 5in. Goodmans, 18/9. 6in. Plessey, 16/9. 8in. Plessey, 16/9. 8in. Rola, 16/9. 10in. Plessey, Heavy duty, 26/9. 10in. R.A. 26/9. 12in. Plessey, 29/11. 10in. W.B. "Stentorian" 3 or 15 ohms type HF1012 10 watts, high-fidelity type. Highly recommended for use with any of our amplifiers. 24/10-.

PLESSEY DUAL CONCENTRIC 12in. 15 ohm HIGH FIDELITY SPEAKER with built-in tweeter (completely separate elliptical speaker with choke, condensers, etc.) providing extraordinarily realistic reproduction when used with our A8 or similar amplifier. Rated 10 watts. Price complete only 25/17 6.

M.E. SPEAKERS 2-3 ohms 8in. R.A. Field, 600 ohms, 11/9. 10in. R.A. Field, 1,000 ohms, 23/9. 10in. R.A. Field, 1,500 ohms, 23/9.

SELENIUM RECTIFIERS			
F.W. Bridge Type	I.T. Types	H.W.	
6/12 v. 1 a.	5/9	6-12 v. Ia, H.W.	2/9
6/12 v. 2 a.	8/9	H.T. Types	H.W.
6/12 v. 3 a.	12/9	150 v. 40 mA.	3/6
6/12 v. 4 a.	16/9	250 v. 50 mA.	5/9
6/12 v. 6 a.	19/9	250 v. 80 mA.	7/9
6/12 v. 10 a.	25/9	250 v. 100 mA.	9/9

R.S.C. 3-4 WATT A7 HIGH-GAIN AMPLIFIER. For 230-250 v., 50 c/c.s. Mains input. Addition of Output and Speakers with exception of output wattage, as A5. Complete Kit with diagrams. £3 15.-. Assembled 22/6 extra. Carr. 3/6.

THE SKYFOUR T.R.F. RECEIVER A design of a 3-valve 200-250 v. A.C. Mains receiver with selenium rectifier. It consists of a variable-Mu high-gain H.F. stage followed by a low distortion anode bend detector. Power pentode output is used. Valve line up being 6X7, 6F81 6F6G. Selectivity and quality are well up to standard, and simplicity of construction is a special feature. Point-to-point wiring diagrams, instructions, and parts list. 1/9. This receiver can be built for a maximum of 24/19.6 including attractive Brown or Cream Bakelite or Walnut veneered wood cabinet 12 x 6 1/2 x 5 1/2 in.

VOLUME CONTROLS with long (1in. diam.) spindle, all valves less switch 2/9; with S.P. switch, 3/9; with D.P. switch, 4/6.

£1 : 2/9 extra under 25.
£2 : 2/9 extra under 45.
£3 : 2/9 extra under 75.
£4 : 2/9 extra under 100.
£5 : 2/9 extra under 130.
£6 : 2/9 extra under 160.
£7 : 2/9 extra under 190.
£8 : 2/9 extra under 220.
£9 : 2/9 extra under 250.
£10 : 2/9 extra under 280.
£11 : 2/9 extra under 310.
£12 : 2/9 extra under 340.
£13 : 2/9 extra under 370.
£14 : 2/9 extra under 400.
£15 : 2/9 extra under 430.
£16 : 2/9 extra under 460.
£17 : 2/9 extra under 490.
£18 : 2/9 extra under 520.
£19 : 2/9 extra under 550.
£20 : 2/9 extra under 580.
£21 : 2/9 extra under 610.
£22 : 2/9 extra under 640.
£23 : 2/9 extra under 670.
£24 : 2/9 extra under 700.

(LEEDS) LTD.

RADIO SUPPLY CO. 32, THE CALLS, LEEDS, 2

LASKY'S RADIO

3-WATT MIDGET AMPLIFIER

A.C./D.C., very high gain. 4 valves: 2 UL41 (p.p.), UCH42, UAF42. Input voltage 100/100, easily converted to 220v. Ideal for record players, recorders, baby alarms, etc. Fully assembled, with valves and circuit diagram. **REDUCED TO 50/-**
Carr. 5/-.

COMPLETE 5-VALVE RADIO CHASSIS

Brand new and unused. A.C. D.C. 200/250 volts. I.F. 465 kc s.A.V.C., 4 watts output, 3-station pre-set, frame aerial fully aligned, chassis 10 x 5 1/2 in. max. height 5 1/2 in. Completely wired and ready for use, with the addition of a speaker and output transformer. Two controls, volume and station switch. Valves used: 10C1, 10F9 or UF41, 10LD11, 10P14, U404 or UY41. **LASKY'S PRICE 52/6**
less valves. Post 3/6 extra.

METER BARGAINS

2 1/2 in. Moving Coil. Brand new Microammeters F.S.D. 0-750 micro/15-amps. 15 ohms rest. ... **15/-**

T.O. CRYSTAL P.U. CARTRIDGES. ACOS HIG type HGP.37 as used in latest radiograms. L.P. and standard, with styl. **22/-** Post 1/-.

B R. Crystal Cartridges, 18/6, post 1/-.

SPECIAL OFFER! GARRARD RC.110 3-SPEED AUTO-CHANGERS

Brand new in maker's cartons. Complete with turnover crystal pick-up. Incorporates automatic record size selection (mixer). Cabinet space required: 14 in. x 12 1/2 in. x 4 9/16 in. above and 2 1/2 in. below motor board. Cream and Brown enamel finish. Limited quantity only. **List £14.13.0. LASKY'S PRICE £8.19.6**
Carr. 5/- Cabinets available.



BIGGEST BARGAIN EVER OFFERED IN TV CATHODE RAY TUBES!



16" METAL CONE C.R.T.

6.3 v. heater. Ion trap, 14 Kv. E.H.T., wide angle 70°, standard 38 m.m. neck, duodecal base, magnetic focus and deflection. Length 17 1/2 in. Gives large black and white picture 11 in. x 14 in. Unused in original cartons. Guaranteed by us 3 months. Full data, connections and suggested time bases supplied with every Tube.

LISTED AT LASKY'S PRICE £9.19.6

£23.9.10

Carr. & Insur., 22 6 extra

Big Picture TV at a Price You Can Afford!

Masks, Anti-Corona Rings, Bases and Ion Traps available.

B.S.R. MONARCH 3-SPD. AUTO-CHANGERS

£7.19.6

Carr. 3/6.

PLEASE ADDRESS ALL MAIL ORDERS TO HARROW ROAD

Open
all day
SAT.
Half day
Thurs.

LASKY'S (HARROW ROAD) LTD.
42, TOTTENHAM COURT ROAD, W.1.
Telephone: MUSEUM 2605.

370, HARROW ROAD, PADDINGTON, W.9.
LADbroke 4075 and CUNningham 1979.

TAPE DECK MOTORS

Anti-clockwise, shaded pole. Limited quantity only.

COLLARO, 25/-.
GARRARD, 26.6.
B.T.H., 29 6,
post extra.

TAPE DECKS

Large range including Collaro, Truvox, Lane, Brenell, etc., in stock.

HOME RADIO OF MITCHAM

187, LONDON ROAD, MITCHAM, SURREY

MIT. 3282

FOR LOW PRICED HIGH FIDELITY EQUIPMENT

F.M. TUNERS

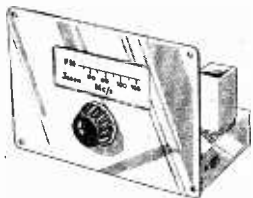

JASON.—As illustrated. Complete kit **£7.5.0.** Full constructional details, price 2/-.

MULLARD.—All parts in stock. Full details in High Quality Sound Reproduction book, price 3/6.

AMPLIFIERS

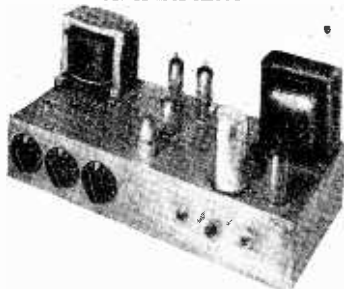

MULLARD.—3 valve 3 watt with independent Bass and Treble controls. Circuit diagram and price list free on request.

MULLARD.—“Five/Ten” full constructional details in Mullard book, price 2/6.

SPEAKERS

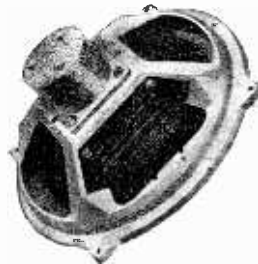

HF1012 10 in. die-cast unit. 10 watts Universal speech coil. Response 30-14,000 cycles. Acclaimed by the technical press, **£4.19.9.**

T.10 tweeter unit, **£4.4.0.** Cross-over network, 30/-.

Full particulars and detailed price lists are available on all these units. We are also demonstrating daily.

HOLIDAYS AHEAD! Build the “Hiwayman” 4 valve All-Dry battery portable **NOW!**

Full constructional details and price list 1/6.

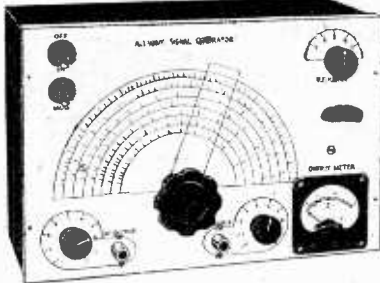

COMPLETELY BUILT SIGNAL GENERATOR

Coverage 120 Kc/s-320 Kc/s, 300 Kc/s-900 Kc/s, 600 Kc/s-2.75 Mc/s, 2.75 Mc/s-8.5 Mc/s, 8 Mc/s-28 Mc/s, 16 Mc/s-56 Mc/s, 24 Mc/s-84 Mc/s. Metal case 10 1/2 in. x 6 1/2 in. x 4 1/2 in. Size of scale, 6 1/2 in. x 3 1/2 in. 2 valves and rectifier. A.C. mains 230-250 v. Internal modulation of 400 c.p.s. to a depth of 30 per cent., modulated or unmodulated R.F. output continuously variable 100 milli-volts. C.W. and mod. switch, variable A.F. output and moving coil output meter. Black crackle finished case and white panel. Accuracy plus or minus 2%. £4/19/6 or 34/- deposit and 3 monthly payments 25/- P. & P. 4/6 extra.

Heater Transformer. Pri. 230-250 v. 6v. 1 1/2 amp., 6/-.

Three-speed automatic changer, B.S.R. Monarch, current model. Will take 7in., 10in. or 12in. records mixed. Turn-over crystal head, cream finish. VERY LIMITED QUANTITY. A.C. mains 200/250. £7.15 0. P. & P. 3/-.

COMMERCIAL TELEVISION CONVERTER

SUITABLE FOR ANY T.V. NO ALTERATIONS TO SET. Complete with built-in power supply, 230-250 v. A.C. mains. Crackle finish case 5 1/2 in. long, 3 1/2 in. wide, 4 1/2 in. high. Incorporating gain control and band switch. Illustrated with cover removed. £3. 19. 6 Plus P. & P. 2 6

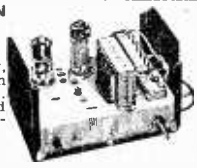

Extension Speaker cabinet in polished walnut, complete with 8in. P.M. P. & P. 3/-. 24 6.

8in. P.M. Speakers, removed from chassis, fully guaranteed. All by famous manufacturers. P. & P. 1.6. 12/6.

Volume Controls. Long spindle less switch, 50 K., 500 K., 1 meg., 2 6 each. P. & P. 3d. each.

GARRARD RC/110 3-SPEED AUTOMATIC CHANGER

10 records, turnover crystal head, brand new. A.C. mains 100/250 v. ... £8. 19. 6 LIST PRICE: £14/10 0. P. & P. 5/-

Volume Controls. Long spindle and switch. 1, 1 1/2, and 2 meg., 4/- each. 10 K. and 50 K., 3/6 each. 1 and 1 meg., long spindle, double pole switch, miniature, 5/-.

Standard Wave-change Switches. 4-pole 3-way, 1/9; 5-pole 3-way, 1/9. Miniature 3-pole 4-way, 4-pole 3-way, 2/6. 2-pole 11-way twin wafers, 5/-; 1-pole 12-way single wafers, 4/-.

16" TUBE BY FAMOUS MANUFACTURER

Brand new E.H.T. 11 Kv. Heater. 6.3 volts 0.6 amp., guaranteed 3 months. £9. 19. 6 E. H. T. and scanning components Post, packing and available. Insurance 22.6. H.P. terms available.

1,200 ft. High Impedance recording tape on aluminium spool 1 1/2 6 post paid.

Polishing attachment for electric drills. Quarter-inch spindle, chromium-plated, 5in. brush, 3 polishing cloths, and one sheep-skin mop, mounted on a 3in. rubber cup. P. & P., 1.6. 12/6. Spare sheep-skin mops, 2 6 each.

R. & T.V. COMPONENTS (ACTON) LTD.

23, HIGH STREET, ACTON, LONDON, W.3

3-speed TRANSCRIPTION MOTOR BY FAMOUS MANUFACTURER

Complete Kit of parts comprising accurately balanced precision made heavy turntable with rubber mat, large constant speed condenser, starting motor, base plate. Can be assembled in half-an-hour. A.C. Mains 200/250 v. Fully guaranteed. Parts sold separately.



£6. 19. 6

Post paid.

PATTERN GENERATOR

40-70 Mc/s direct calibration, checks frame and line time-base, frequency and linearity, vision channel alignment, sound channel and sound rejection circuits and vision channel band width. Silver-plated coils, black crackle-finished case 10" x 6 1/2" x 4 1/2" and white front panel. A.C. mains 200/250 volts. This instrument will align any TV receiver, accuracy +1%. Cash price £3/19/6 or 28/- deposit and 3 monthly payments of £1 P. & P. 4/6 extra.

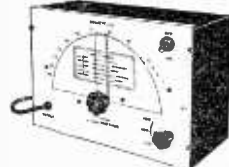

T.R.F. KIT in PLASTIC CABINET

3 valve plus metal rectifier. A.C. mains 200-250 v. Medium and Long waves. In pastel blue or brown. Valve line-up: 2 VR655 and VT52. Size 15 1/2 in. long by 9 in. high by 7 in. deep. £3. 19. 6 P. & P. 4/6.

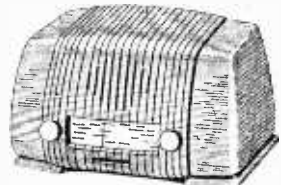

Used Metal Rectifier, 20 v. 50 mA., 3/6; gang with trimmers, 6/6; M. & L. T.R.F. coils, 5/-; 3 Govt. valves, 3 v/h and circuit, 4/6; heater trans., 6/-; volume control with switch, 3/6; wave-change switch, 2/-; 32 x 32 mfd., 4/-; bias condenser, 1/-; resistor kit, 2/-; condenser kit, 4/-.

P.M. SPEAKERS, 6 1/2 in., closed field, 18/6. 8 in., closed field, 20/6. 10 in., closed field, 25/-, 12 in., 25/-, 3 1/2 in., 18/6. P. & P. on each 2/-. Valveholders, Paxolin octal, 4d. Moulded octal, 7d. EF50, 7d. Moulded B7C, 7d. Octal amphenol, 7d. Octal pax., 7d. Mazda Amph., 7d. Mazda pax., 4d. B8A, B9A amphenol, 7d. B7C with screening can, 1/6. Duodecal paxolin, 9d.

Twin-gang .0005 Tuning Condensers, 5/-. With trimmers, 6.6.

32 mfd., 350 wkg. ...	2/-	16+16 mfd., 350 wkg. ...	3 3
16 x 24 350 wkg. ...	4/-	60+100 mfd., 280 v. wkg. ...	7/-
40 mfd., 200 wkg. ...	1/3	50 mfd., 180 wkg. ...	1/9
40 mfd., 450 wkg. ...	3/6	65 mfd., 220 wkg. ...	1/6
16 x 8 mfd., 500 wkg. ...	4/6	8 mfd., 150 wkg. ...	1/6
16 x 16 mfd., 500 wkg. ...	5/9	50 mfd., 12 wkg. ...	11d
16 x 16 mfd., 450 wkg. ...	3/9	50 mfd., 50 wkg. ...	1/9
32 x 32 mfd., 350 wkg. ...	4d.	Miniature wire ends	
25 mfd., 25 wkg. ...	11d.	moulded 100 pf., 500 pf.,	
250 mfd., 12 v. wkg. ...	1/-	and 301 ea. ...	7d.
16 mfd., 500 wkg., wire	3/3	280-0-280 80 mA., 4 v. 4 a.,	
ends ...	1/3	4 v. 2 a. ...	14/6
8 mfd., 500 v. wkg., wire	2/6	250 v. 350 mA., 6.3 v. 4 a.	
ends ...	2/6	twice, 2 v. 2 a. ...	19/6
8 mfd., 350 v. wkg., tag	1/6	Auto-trans. Input 200 250	
ends ...	1/6	HT 500 v. 250 mA., 6 v.	
100 mfd., 350 wkg. ...	4/-	4 a. twice 2 v. 2 a. ...	19/6

Potato & Vegetable Peeler, by famous manufacturer, capacity 4 1/2 lbs., complete with water pump. All aluminium construction, white stove-enamelled finish. Originally intended for adaptation on an electrical food-mixer, can easily be converted for hand operation. 39/6. P. & P. 3/-.

Where post and packing charge is not stated, please add 1/6 up to 10/-, 2/- up to £1 and 2/6 up to £2. All enquiries S.A.E. Lists 5d. each.

3-WAVE SUPERHET

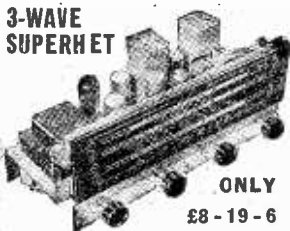

ONLY
£8-19-6

This is a 5-valve A.C./D.C. superhet covering the usual long, medium and short wavebands. It has a particularly fine clear dial with an extra long pointer travel. Osram valves are used and the chassis is complete and ready to operate. Chassis size 15 x 6 x 6in. Price £8/19/6, complete with 8in. or 6in. speaker. Carriage and insurance 10/-, H.P. terms if required.

TV (BAND III) PRE-AMP



In difficult areas it will be necessary to increase the signal level and this is the ideal unit for this purpose. It is A.C. mains operated and is fitted with input and output coax. plugs. Price £4. Post and Packing 3/6

NEW CIRCUIT

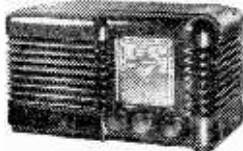

OCCASIONAL 56—we have evolved a new T.R.F. circuit and have had really good results, equal in fact to many superhets. You really should try this circuit. All parts including valves (6K7, 6J7, 6P6, and 6X5) and Bakelite case with back cost only £5/10/-, plus 2/6 post and insurance. Data included with the parts is also available separately, price 2/-.

THE CLEVELAND ORGANTONE



5 valve 3 waveband superhet covering Long, Medium and Short waves. Osram miniature valves—low loss iron coils—permeability—tuned I.F.S.—full A.V.C.—variable negative feed-back—gram. position—4 watts out-put—particularly fine tone. Chassis size 7in. x 7in. x 7in. approx. Tested in difficult areas, where exceptional results have been obtained. Price £11/10/0 or £3/16/0 deposit. Carriage and ins. 10/-.

STOP PRESS SNIP

.1 MFD 350v. Tubular Metal Case Condenser 3/- per dozen, gross lots post free otherwise add 1/-.

AM/FM RADIOGRAM CHASSIS

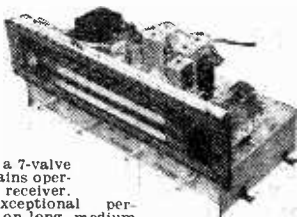

This is a 7-valve A.C. mains operated receiver. An exceptional performer on long, medium and short A.M. bands and on the new V.H.F. band. It is an ideal unit for a quality radiogram. Special features include magic eye tuning indicator, extra long scale and pointer travel—latest circuitry employing full A.V.C. feed-back, etc., etc. Undoubtedly one of the finest AM FM chassis available today. Chassis size 17in. x 6in. x 7in. Price £23/17/6, carriage, packing and insurance 20/- extra.

RECORD PLAYER £4/10/0

3-speed Gramophone Motor



Latest rim drive 3-speed motor with metal turntable and rubber mat. Small mod. makes speed easily variable for special effects and dance work. Using famous Cosmocord Hi-G turn-over crystal. Separate sapphire for each speed. Neat bakelite case with pressure adjustment. **Special Snip Offer This Month**. The two units for £4/10/-, plus 5/- post and insurance, or made up on board as illustrated, £5/10/-, plus 5/- post.

THIS MONTH'S SNIP RADIO SCALES 6/6 DOZEN

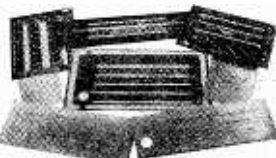

An exceptional bargain this month is our assorted parcel of radio scales. A most useful collection for all who make up experimental or other radios. We offer twelve assorted scales mostly in two or three colours for 6/6, plus 2/6 post and packing. Limited quantity only.

VACUUM RELAY

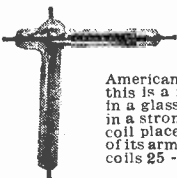

American made type No. C.61610, this is a relay completely sealed in a glass envelope. It will close in a strong magnetic field or by a coil placed close to or round one of its arms. Price 40.6. Operating coils 25/- each.

OFFICE TELEPHONES

New G.P.O. telephone sets with internal bell and push button switch easily connected together to form office intercom. Price £2/10/0 each. Post etc., 2/6.



IMPULSE RELAY

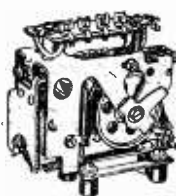

Somewhat soiled due to storage but mechanically O.K. Price 2/6, few new and unused 6/6 each, plus 6d. post. Booklet giving some circuits price 1/- post free.

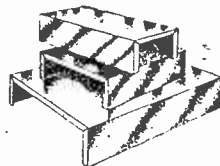

BLANK CHASSIS 18 S.W.G. Aluminium

7-3/4-2	3/9	14-19-3	7/9
9-4-21	5-	16-10-3	8/3
10-8-21	5/6	16-12-3	8/8
10-5-21	5/-	19-9-21	8/3
12-9-21	7/-		
14-9-21	7/6	20-10-3	10/-



CONNECTING WIRE

P.V.C. covered in 100ft. coils—2-9 a coil or four coils different colours, 10/- post free.

FINE TUNERS

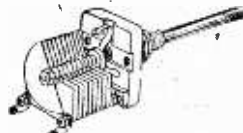

Ceramic trimmers all with 1/4in. spindles of fair length. 5, 10, 15, 30, P.F. at 2/3 each or 24/- per dozen.

W.D. CIRCUIT DETAILS

Diagrams and other information extracted from official manuals. All 1/6 per copy, 12 for 15/-, American Service

Sheets	R.109
A.134	78 receiver
BC.349	76 receiver
BC.312	R28/ARC5
R.103A	R1116/A
B.C.342	RA-1B
RA-1B	ARSD
R-208	AN/APA-1
R-1155	78
R-1124A	76
R-1132A, R-1481	R.T.18
R-1147	CAY-46-AAM-
R-1224A	RADAR
R-1082	A.S.B.-3
R-1355	Indicator 62A
B.C.1206-A/B	Indicator A.S.B.3
B-455-A (or -B)	Indicator 52
B-454-A (or -B)	Indicator 6K
B-453-A (or -B)	R.F. unit 24
Transmitter T1154	R.F. unit 26
Fifty-eight walkie talkie	R.F. unit 25
Frequency meter	R.F. unit 27
B.C.221	Wireless set No.19
	Demobbed valves

HUGE MINISTRY PURCHASE

R.1155—yours for £2 down

Frequency 75 kc/s to 18 mc/s—10 valves—metal case—robust receiver—cost over £60 to make—will give years of service, very little used. Price £10 or 5 payments of £2. Cash & transit case 15/- et.

ENGINEERS 1" MICROMETER

Brand new and perfect—invaluable to engineers, apprentices, model makers, students, etc. Only 10/- post free.

5-VALVE SUPERHET YOURS FOR ONLY £1 DOWN



Chassis size approx. 9 1/2 x 8 1/2. First-class components. A.C. mains operation. Three waves (medium and two shorts). Complete with five valves, ready to work. New and unused. Cash price £5/19/6. or 6 payments of £1 (carr. and ins. 7/6).

TRANSFORMER SNIP

11/6 Post 2/-

Fully shrouded—standard 200-250 v. primary 280-0-280 at 80 m.a. 6.3 v. at 3 amp., 5 v. at 2 amp.



THE TWIN 20



This is a complete fluorescent lighting fitting. It has built-in ballast and starters—stove enamelled white and ready to work. It is an ideal unit for the kitchen, over the work-bench, and in similar locations. It uses two 20-watt lamps. Price, complete less tubes, 29/6. or with two tubes, 39/6. Post and insurance 5/-. Extra 20-watt tubes, 7/6 each.

MAINS-MINI

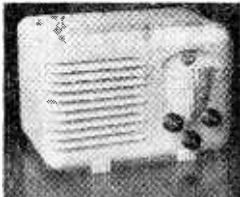

Uses high-efficiency coils—covers long and medium wavebands and fits into the neat white or brown bakelite cabinet—limited quantity only. All the parts, including cabinet, valves, in fact, everything, £4 10/0, plus 3/6 post. Constructional data free with the parts, or available separately 1/6.

The "CRISPIAN" Portable Radio



A 4-valve truly portable battery set with very many good features as follows: Ferrite rod aerials, low consumption valves, superhet circuit with A.V.C., ready-built and aligned chassis if required, beautiful two-tone cabinet covered with I.C.I. Rexine and Tygan. Guaranteed results on long and medium waves anywhere.

All parts, including speaker and cabinet, are available separately or if all ordered together the price is £7/15/6 complete, ready-built chassis 30/- extra. Instruction booklet free with parts or available separately price 1/6.

GRAMOPHONE AUTO-CHANGERS

The latest models by very famous manufacturers. 3-speed with crystal turn-over pick-up, brand new and perfect, in original cartons. Prices from £7/15/0. carriage, ins., etc., 7/6.

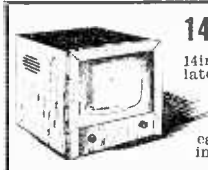

14" T.V. CABINET

14in. T.V. cabinet of the latest styling made for one of our most famous firms—beautifully veneered and polished—limited quantity—19/6 each. Carriage and packing 3/6 extra.

THE STATESMAN



THIS IS ON OFFER AT APPROX. HALF COST TO MAKE.

An impressive costly looking cabinet originally designed for T.V. but simple modification makes the cabinet suitable for radio-gram amplifier, tape recorder, or reflex speaker—size 23in. wide, 22in. deep and 37in. high. Limited quantity at £3/15/- each, carriage 12/6.

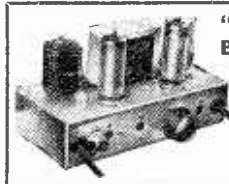

"The ESTRONIC" Band III Converter

To-day's best value in Band III converters suitable for your T.V. or money refunded. Complete ready to operate. 59/6 non mains or 85/- mains, post and insurance 3/6.

THE CLEVELAND F.M. TUNER

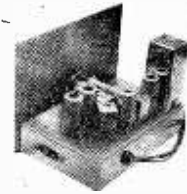

This tuner is based upon the very successful circuit published by Data Publications. We have made up models at all branches and will gladly demonstrate. Stability is extremely good and making and aligning most simple. Cost of all parts including valves, prepared metal chassis, wound coils and stove enamelled scale, slow-motion drive, pointer, tuning knob, in fact everything needed is 26/12/6. Data is included free with the parts or is available separately, price 2/-



MULLARD AMPLIFIER "510"

A Quality Amplifier designed by Mullard. Power output exceeds 10 watts. Frequency response almost flat from 10 to 20,000 C.P.S. For use with the Aco's "Hi G" and other good pick-ups. Made up and ready to work is £12/10/- plus 10/- carr. and insurance.

MULTI-METER KIT

Parts suitable for making a multimeter to measure volts, milliamps and ohms. Kit containing all the essential items including moving-coil meter, resistors, range selector, calibrated scale, etc., etc., is only 15/- plus 1/- post and packing.

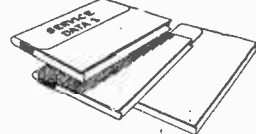

SERVICE DATA

100 service sheets, covering British receivers which have been sold in big quantities and which every service engineer is ultimately bound to meet. The following makers are included: Aerodyne, Alba, Bush, Cossor, Ekco, Ever-Ready, Ferguson, Ferranti, G.E.C., H.M.V., Kolster, Brandes, Lissen, McMichael, Marconi, Mullard, Murphy, Philco, Philips, Pye, Ultra. Undoubtedly a mine of information invaluable to all who earn their living from radio servicing. Price £1 for the complete folder.

ELECTRONIC PRECISION EQUIPMENT, LTD.

Post orders should be addressed to E.P.E., LTD., Dept. 5, 123, Terminus Road, Eastbourne.

Post enquiries to Eastbourne with stamped envelope, please.

42-46, Windmill Hill, Ruislip, Middx.	152-3, Fleet Street, E.C.4.	29, Stroud Green Rd., Finsbury Park, N.4.	249, Kilburn High Way, Kilburn, MAIda Vale 4921.
Phone: RUISLIP 5780.	Phone: FLEEt 2833	Phone: ARChway 1049	
Half day, Wednesday.	Half day, Saturday.	Half day, Thursday.	

IF YOU WANT A GOOD **Microphone**
 WITHOUT HAVING TO PAY TOO MUCH FOR IT
What about one of these ?

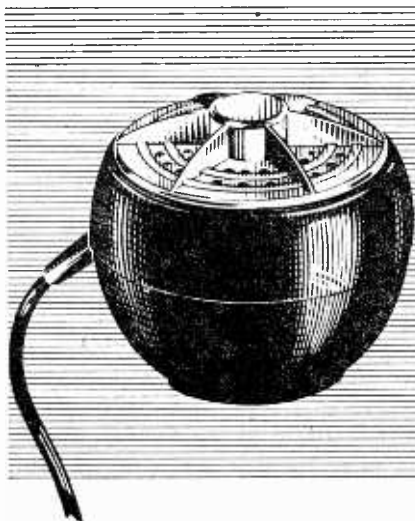

MIC 33

A crystal microphone that fits the hand perfectly. For the high quality public address and tape recording field, incorporating a specially designed acoustic filter giving a flat response from 30 to 7,000 c/s.

RETAIL PRICE £2.10.0

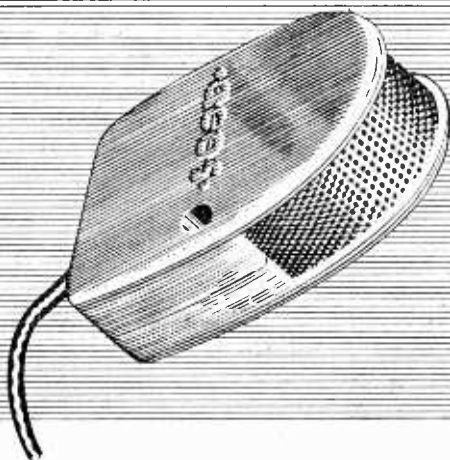

MIC 35

A general purpose hand microphone of robust construction and convenient "handling" qualities with substantially flat response from 50 to 5,000 c/s. Suitable for recording apparatus, Public Address equipment, etc.

RETAIL PRICE £1.5.0

acos

always well ahead

ACOS devices are protected by patents, patent applications and registered designs in Great Britain and abroad.

COSMOCORD LIMITED · ENFIELD · MIDDLESEX · Tel: ENField 4022

PRACTICAL WIRELESS

EVERY MONTH
VOL. XXXII, No. 595, JULY, 1956

EDITOR: F. J. CANN

24th YEAR
OF ISSUE

COMMENTS OF THE MONTH

BY THE EDITOR

The Future of Sound Radio

SIR IAN JACOB, Director-General of the BBC, in a speech given to members of the International Radio Consultative Committee, had some pertinent remarks to make concerning the future of sound radio, which still has a position of profound importance which will continue for many years to come. Television is, of course, at present stealing the limelight, but sound radio cannot, like the silent films, go out of existence altogether because of video-sound programmes. The BBC is carrying out a complete conversion from long and medium waves to VHF, and this is an indication of their continuing belief in the necessity for a full range of services in radio. "No living organism can remain static, and there will no doubt be changes as the years go by in the scope and nature of radio services to meet changing conditions. The spread of television is not so vast as to cause us to foresee drastic changes in radio in the near future."

Our own view is that the technique of sound radio will undergo quite drastic changes within the next five years. Many of the features are now better served by TV, and apart from improvements in reception, such as is provided by VHF, there will be a rapid change in the nature of sound programmes. We do not think that plays and similar forms of entertainment can continue in view of the better visual and aural presentation provided by television, and the BBC therefore must find other programme material to fill the gap. We also feel that programmes which largely appeal to bobbysoxers will be accorded much less programme time than at present, and there may be fewer parlour games.

It is for the BBC to decide how it can remould its programmes to compete with television. There are certain items such as the news and weather forecasts, which do not need vision, and the aim should be to introduce such programmes as can be listened to without the need for the listener building up in his mind a mental picture of what is happening in the studio.

The BBC is guided here by its Audience Research Department, and the conflict in claims made on behalf of the BBC and the ITA about the proportion of the total audience viewing each TV service does not lead us to suppose that the results are any more accurate as they relate

to sound programmes. It may be that new methods of audience research will have to be devised; certainly those at present in use are inaccurate.

It is perhaps a sign of the times that at the end of March, 1956, sound licences had dropped by nearly one million, whilst TV licences had increased by one and a quarter million. The total number of licences issued was 14,261,551, as compared with 13,980,496 the previous year. A breakdown of these figures shows that sound licence figures have dropped from 9,476,730 to 8,521,958, and television licences have increased from 4,503,766 to 5,739,593 during the year. These figures bear out the forecast which we made in this journal when TV reopened its services after the war.

"YOU'RE ON THE AIR"

AN interesting pamphlet obtainable free at all main post offices has just been issued by the Press and Broadcast Division of the G.P.O. Its cryptic title is intended to draw attention to the unwitting broadcasters, those who operate electrical apparatus such as hair driers and sewing machines and thereby cause interference. Refrigerators, vacuum cleaners, electric shavers, power drills, and even radio and TV sets are all broadcasters of unwanted signals to which has been given the general name of interference. The owner of a TV set who complains of interference caused by his neighbour's portable drill may be unaware that electrical equipment in his own home is causing similar interference with his neighbour's TV or radio. Faulty connections, worn electrical equipment, poor earthing, failing valves are common sources of interference apart from being uneconomical and sometimes dangerous in use. The G.P.O. will help to trace the cause and prescribe the cure. Regulations make it possible for the Post Office to serve a legal notice on anyone who fails to comply with a request to have his equipment put in order when it has been found to be causing interference. This notice gives less than 28 days to deal with the matter, and if it is ignored the owner of the offending apparatus becomes liable to a fine up to £10 on the first occasion, and to a fine up to £10 after that.—F. J. C.



Round the world of WIRELESS



Broadcast Receiving Licences

THE following statement shows the approximate number of broadcast receiving licences in force at the end of March, 1956, in respect of wireless receiving stations situated within the various postal regions of England, Wales, Scotland and Northern Ireland. The numbers include licences issued to blind persons without payment.

Region	Totals
London Postal	1,323,645
Home Counties	1,299,852
Midland	1,025,052
North Eastern	1,338,119
North Western	1,021,392
South Western	837,208
Wales and Border Counties	525,946
Total England and Wales	7,371,214
Scotland	945,293
Northern Ireland	205,451
Grand-Total	8,521,958

During March the number of television licences increased by 90,327.

14,261,551 broadcast receiving licences, including 5,739,593 for television, and 293,459 for sets fitted in cars, were current in Great Britain and Northern Ireland at the end of March, 1956.

Amateur Wireless Licences

AS from April 1st, 1956, the fee chargeable to prospective Amateur Licence holders for a morse test was increased from 7s. 6d. to 10s. Morse tests will be conducted by the Post Office on request at the following centres:

(a) G.P.O. Headquarters, St. Martin's-le-Grand, London, E.C.1.

(b) Post Office Coast Stations, i.e., Burnham, Cullercoats, Humber, Land's End, Niton, North Foreland, Oban, Port Patrick, Seaforth, Stonehaven and Wick.

(c) Radio Surveyor's Offices, i.e., Belfast, Cardiff, Falmouth, Glasgow, Hull, Leith, Liverpool, Newcastle-on-Tyne and Southampton.

In order to meet the need of applicants who cannot conveniently reach the above places, tests will also be held, provided there are sufficient candidates, twice a year (January and September) at the following Head Post Offices: Birmingham, Cambridge, Derry, Leeds and Manchester.

Radio Show Fully Booked

FOR the first time in the history of the Radio Show the avail-

able space has been entirely booked up at the ballot stage, more than four months before the opening.

This was stated by the Radio Industry Council at the conclusion of the ballots at the Connaught Rooms, London, when each applicant made his choice of stand as his name was drawn from a revolving drum.

All the big names in radio were represented among the hundred firms booking space.

"The demand has been greater than ever," said Mr. F. W. Perks, chairman of the Exhibition Organising Committee of the Radio Industry Council, "and we have had unusual difficulty in finding space for exhibits, demonstration rooms and offices for all who want them.

"The bookings show the confidence of the industry in the expansion of sound radio and television broadcasting and the continued success of the annual show as a public event of the year."

The Radio Show is being held at Earls Court, London, from August 22nd to September 1st,

with a preview for overseas visitors and other special guests on August 21st. Our stand is No. 111.

Atomic Weapons Range

INSTRUCTIONS have been given to British Insulated Callender's Construction Company by Sir Alexander Gibb and Partners to supply and supervise the installation of an electrical network for the new weapons range at Maralinga, in the heart of the South Australian desert.

The work in Australia will be carried out in collaboration with British Insulated Callender's Cables (Australia) Pty., Ltd.

British Firms Co-ordinate Resources

AUTOMATIC TELEPHONE & ELECTRIC CO., LTD., and Marconi's Wireless Telegraph Co., Ltd., have concluded an agreement for co-operation in the field of telecommunications. The resources of the two companies will be co-ordinated as regards development, production, planning, installation and maintenance, to enable them jointly to meet the widest possible range of telecommunications requirements.



The Philco Salesmen with London's Pearly King and Queen at the Airport.

Champion Salesmen Visit London

A PARTY of 56 TV and radio equipment salesmen from all parts of the United States of America recently arrived at London Airport on the first stage of an 18-day tour of the world.

This round-the-world tour, which has the endorsement of the State and Commerce Department of the United States as a force for international harmony and understanding, is the prize awarded to the winners of a nationwide retail sales competition organised by The Philco Corporation of Philadelphia.

The salesmen spent a "non-stop" 48 hours in the capital. After a coach tour of London, they attended a reception at Grosvenor House, where they were welcomed to this country by the American Ambassador. The senior Pearly King and Queen had greeted them at the airport and were present at the reception together with other familiar London types—a bus-driver and "clippie," a postman and postwoman, a Doggett's Coat and Badge winner, two 74-year-old Chelsea pensioners, and a sergeant-piper of the 1st Bn. Scots Guards in full-dress uniform.

Mr. Fred Willard, vice-president of the Philco International Corporation, accompanied the party.

Wireless for the Blind

BLINDED at Cambrai in 1918 while serving with the Royal Army Service Corps, Mr. A. J. Porter, Seven Kings, has received from Sir Ian Fraser the fiftieth dunstan set presented to St. Dunstan's by Fort Dunlop workers.

BBC Engineer-in-Charge at Daventry

MR. F. N. CALVER, M.B.E., the Engineer-in-Charge at the BBC's Daventry transmitting station, retired on April 30th, 1956, and Mr. H. A. Masters, the former Assistant Engineer-in-Charge there, has been selected to replace him.

Mr. Masters, who was born in 1901, joined the BBC in July, 1930, after service with the Marconi Company and with the G.P.O., where he was Shift Officer in charge of transmitters at Northolt, Devises, Bodmin and Rugby.

After a short period on London Station, Mr. Masters was transferred to Belfast and in June, 1932, to the Moorside Edge transmitting station. He went to Daventry in January, 1933, and was promoted to Assistant Engineer-in-Charge in November, 1949.

New Phototelegram Service

CABLE AND WIRELESS LTD. announces the opening of a new phototelegram service between Hong Kong and Manila. Cable and Wireless, Ltd., will operate the Hong Kong end and R.C.A. Communications Inc. the Manila end.

Charges at each end are, respectively, 85 Hong Kong dollars or 15 American dollars for the first 150 sq. cms., and 42½ Hong Kong or 7½ American dollars for each additional 100 sq. cms.

Amateur Trophy

EACH year the British Commonwealth Broadcasting unit, Kure, Japan, presents a trophy to the best world amateur picking up its programmes. The trophy for 1955 shown on the right goes to an amateur in Sweden, who has reported good reception throughout the year.

Duke of Edinburgh's Study Conference

THE Study Conference on the Human Problems of Industrial Communities within the Commonwealth and Empire, to be held in Britain this summer under the Presidency of H.R.H. the Duke of Edinburgh, has evoked tremendous interest both in this country and overseas.

Mr. R. Telford, 40-year-old General Works Manager of Marconi's Wireless Telegraph Company, Limited, has been honoured by selection as a Group Chairman of one of the Conference Study Groups.

Robert Telford, B.A., A.M.I.E.E., M.I.Prod.E., M.I.I.A., was educated at Queen Elizabeth's Grammar School, Tamworth, Staffs, and Christ's College, Cambridge. He joined Marconi's in 1937, when he started a two-year course of managerial training, involving experience in all departments, with special emphasis on works management.

He was appointed to his present position as General Works Manager of the company's various establishments in 1953.

Philips Car Radio.

NATIONAL evening, provincial and trade press advertising will be used in an intensive campaign launched by Philips Electrical Limited for their Car Radio. Model 344V.

Other plans include a broadside mailing to radio dealers and to 25,000 garages, service stations, etc., throughout the country.

The campaign will continue until the end of June.

The old title of "MotoRadio"

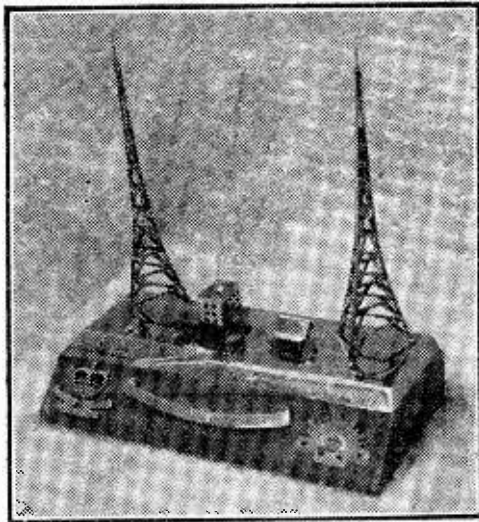

The Japanese Amateur Trophy.

has now been discontinued. In future the product will be known as "Philips Easy-to-fit Car Radio."

Obituary

IT is with deep regret that we announce the death of Mr. Norman Charles Robertson, C.M.G., M.B.E., Deputy Managing Director of E. K. Cole, Ltd., and a director of Ekco Electronics, Ltd.

Mr. Robertson, who was 47 years old, died at his home, The Old Vicarage, Burnham-on-Crouch, Essex, in April.

Amateur Wireless Licences

THE Postmaster General announces that with effect from the 1st March, 1956, the use of the 7 Mc/s band by holders of Amateur Wireless licences has been restricted as follows:

7.00 to 7.10 Mc/s for exclusive use by amateurs. 7.10 to 7.15 Mc/s to be shared with other services.

Frequencies between 7.15 Mc/s and 7.30 Mc/s will no longer be available to amateurs.

A Novel Radio Control Receiver

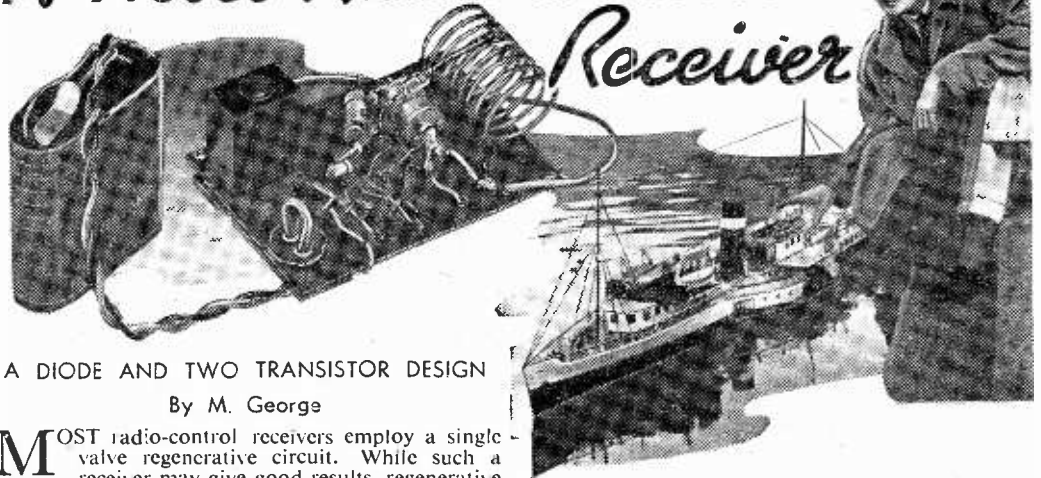

A DIODE AND TWO TRANSISTOR DESIGN

By M. George

MOST radio-control receivers employ a single valve regenerative circuit. While such a receiver may give good results, regenerative circuits are often temperamental and even the modern valves tend to put rather a heavy drain on miniature batteries. The circuit described here, once set up, is completely reliable and consumes only about $\frac{1}{2}$ mA from three unit cells. In fact it will operate continually for several weeks on one battery before it has to be discarded as "flat."

The Circuit

The circuit is quite simple, as can be seen from Fig. 1. A GD3 germanium diode and two type O.C.71 transistors are used. A short wire aerial feeds into a tuned circuit consisting of L1, C1. The tuned circuit is matched to the diode D by a tapping on L1. The signal developed across L1 is rectified by the diode and applied to the base of the transistor T1. The condenser C2 is a 1,000 pF component and serves to bypass any R.F. to earth, also it builds up a small negative bias at the point A when a signal is received. The polarity of connection of the diode is important, as a negative voltage must be produced at A in order to operate the receiver correctly. Most germanium diodes have one end painted red, and the other end black or left unmarked. The red end is connected to the coil and the other end to T1.

The 1 M Ω resistor R1 applies a small standing bias to the base of T1 and ensures that the transistor operates on the steepest part of its curve. T1 is connected in an earthed emitter circuit and has its collector directly connected to the base of the second transistor T2. The resistance R2 acts as a collector load for T1 and also provides the correct working bias at the base of T2. The emitter of T2 is earthed and the collector is connected through the relay to the

battery. The relay should not have too high a resistance, but must be a sensitive type. Those specially designed for radio-control have a resistance of about 4,000-5,000 ohms and can be set to close on a current change of about .2 mA. Those marketed by E.D. (Electronic Developments, Ltd.) and obtainable through most model shops are ideal. A relay with a resistance of more than 5,000 Ω should not be used, as it will reduce the standing current too much. A 4.5 volt battery is used. In the prototype a standard 4.5 volt flash-lamp battery was used, as this also had to supply power to the escapement controlled by the relay. However, if weight is of importance, three 1 $\frac{1}{2}$ volt deaf-aid cells could be used and would have a long life as the current drain is so small.

Operation

The operation of the circuit is quite simple. When a signal is received it is rectified by the diode D and a small voltage is produced at A. This is amplified by the transistors T1 and T2 and produces a comparatively large current change in the collector circuit of T2 which operates the relay.

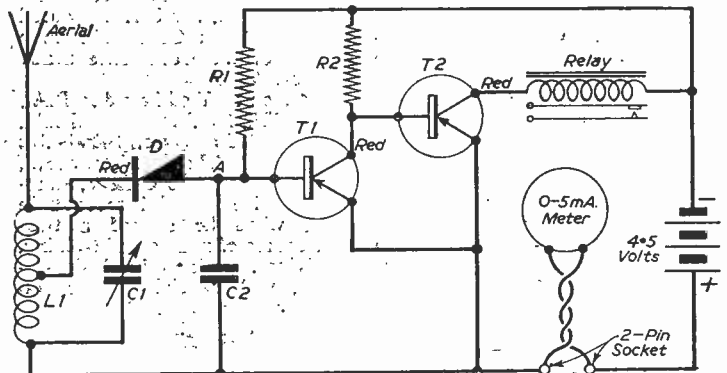

Fig. 1.—Theoretical circuit of the receiver.

Construction

The receiver is most conveniently constructed on a small paxolin panel. No special layout is required, although leads to the coil L1 and tuning condenser C1 should be kept as short as possible. A suggested

and relay leads are easily secured by taking them through two small holes in the panel in a similar way to that shown for the coil in Fig. 3.

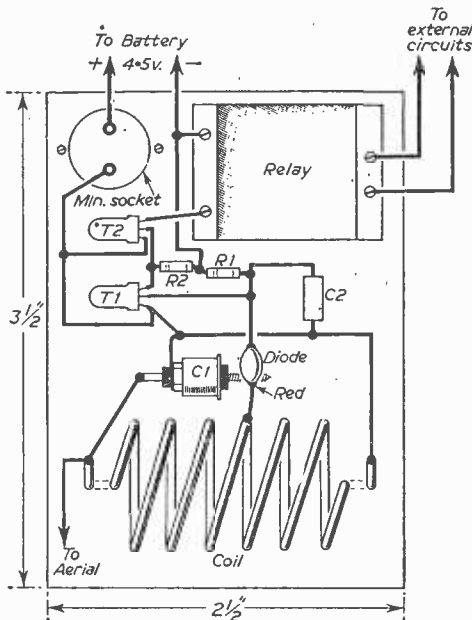
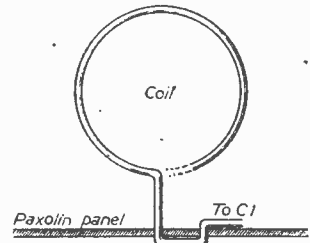

Fig. 2.—Wiring diagram of the receiver.

layout which was employed in the prototype is shown in Fig. 2. The coil L1 is self supporting and is wound from 16 gauge tinned copper wire. Together with C1 it has to tune to a frequency in the model control band, i.e., between 26.96 Mc/s and 27.28 Mc/s. Nine turns are wound to a diameter of 1in. and are spaced to a length of 1 1/2 in. The coil can be conveniently mounted by looping the ends through two holes in the paxolin panel as shown in Fig. 3. The condenser C1 is a 0-30 pF concentric type trimmer as found in many surplus R.F. units.

The tapping for the diode is best found by trial, but good results are usually obtained with a tapping half-way along the coil, although the optimum position depends on the diode and transistor T1. The transistors are soldered directly into the circuit, but the leads should be held in a pair of pliers while soldering as transistors are easily damaged by heat. A small loop of wire is taken round the body of each transistor and through two small holes in the panel; the loop is then twisted tight on the reverse side and serves to hold the transistors in place. The aerial, battery

Details of the coil and method of mounting. It should be perfectly rigid.



Setting up the Receiver

The aerial should be between 1ft. and 18in. long, although if initial tests are to be made at close range it is best to use a shorter aerial. The diode should be connected to the mid-point of the coil and a 20 KΩ resistance in series with a 500 KΩ variable inserted in place of R2. A 0.5 mA meter should then be placed in the positive battery lead. A convenient way of doing this is to provide a miniature two-pin socket on the panel, and to connect the receiver to one terminal and the battery + to the other. The meter can then be plugged directly into the circuit—and a shorted plug can be used to replace the meter once the receiver is set up. The receiver can then be switched off simply by removing the shorted plug.

With the transmitter off, the 500 K variable should be set to maximum resistance and the batteries connected up. The variable in place of R2 should then be adjusted to obtain a standing current of between 1/2 mA and 3/4 mA. If the current cannot be brought to this value, it is probable that T1 has a

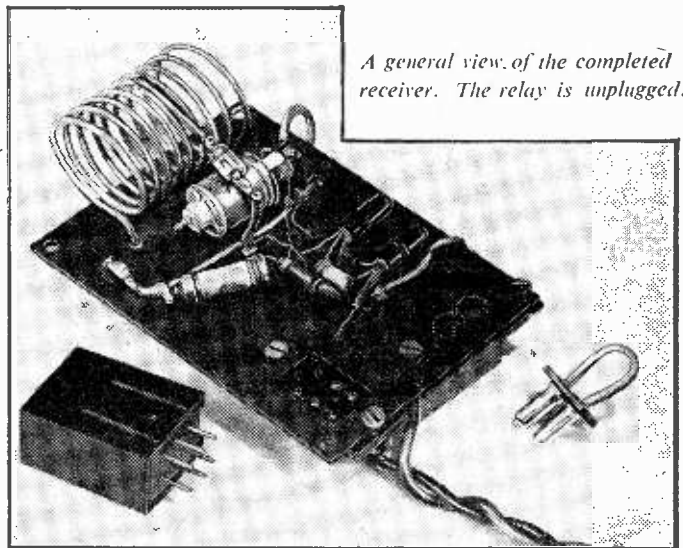

A general view of the completed receiver. The relay is unplugged.

slightly higher leakage current than usual and RI can be increased to 2 M Ω or removed altogether. Having set the current to this value, the variable can then be replaced by a fixed resistor of the appropriate value.

Next the transmitter should be switched on and CI carefully adjusted until the meter shows a current drop. The exact tuning point is quite critical and a drop to more or less zero should be obtained at close range. Unless the transmitter is altered, no further tuning adjustment will be required and the relay can then be set to close on as small a current drop as possible, as the change obtained decreases with increasing range. If a specified model control type is used, no difficulty should be experienced in setting it to close on a current change of 0.2 mA or less. The relay will normally be used to control other mechanisms and power for these may be obtained if desired from the receiver battery.

The prototype had a range of about 50yd. using an 18in. receiver aerial and a 9ft. aerial on a very

low-powered transmitter. If a little care is taken in the construction and setting up of the receiver it

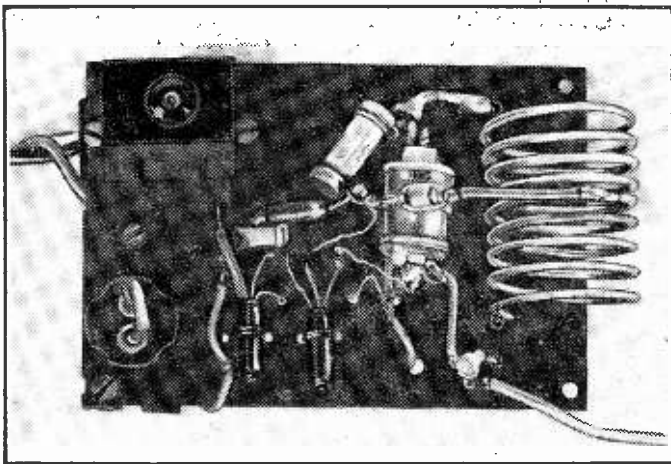

Another view of the finished receiver.

should give long periods of trouble-free operation without battery replacement.

Five Million Radio Components Daily

FIVE million radio and electronic components are made by British manufacturers every working day of the week, according to the 23rd annual report of the Radio and Electronic Component Manufacturers' Federation presented to the 1956 annual general meeting in London.

Production in 1955 rose by 30 per cent. compared with the previous year; it has doubled during the past four years and is now at seven to eight times the pre-war level. In value, current output at £58 million is stated to be 10 times the pre-war level. Exports, including components for sound reproduction equipment, were worth £13.4 million in 1955, an increase of nearly 23 per cent. on the previous year. Components other than sound reproduction parts showed a rise of 10 per cent. and sound reproduction products (at nearly £5 million) a rise of 52 per cent., indicating the rapidly increasing demand for British high fidelity sound equipment.

Hi-Fi Apparatus

The United States is now the principal British market for high fidelity sound reproduction products and Canada the second largest purchaser of components, India being the principal customer.

During 1955 there were substantial increases in sales to Mexico, Iraq, Western Germany, New Zealand, South Africa, U.S.A., India and the Rhodesias but falls in exports to Sweden (by 9 per cent.) and Denmark (by 10 per cent.). The total demand for components exceeded the capacity of the industry despite its 30 per cent. expansion in output and considerable quantities of components were imported. "It is hoped," the report states, "that during 1956 the expansion now taking place in component production will restore the balance and render these excessive importations no longer necessary."

The Neurotic Electronic Brain

ONE of the most interesting exhibits from the human point of view at the Physical Society's Exhibition in May was the Electronic Trainer examining Eucrates I, a forgetful, neurotic electronic brain and training it to become competent.

This took place on the stand of the Solartron Electronic Group, Ltd.

The trainer educates in a systematic way. At first it asks easy questions, which the human operator answers by pressing certain unlabelled switches, being given at the start of the training very full clues as to what he should do. The clues become more difficult as the operator becomes more proficient. Also, as the operator becomes certain of the easy questions, these are dropped and the more difficult and then increasingly difficult questions are asked, until the operator is a complete master of his subject.

Eucrates I is named after the original Sorcerer's Apprentice, a character of Lucian, the Greek satirist. In Walt Disney's "Fantasia" he was shown thoroughly overpowered, flustered and muddled, because he tried to assimilate the magician's knowledge far too quickly.

Eucrates I is by far the greatest advance in the creation of an electronic brain which forgets and has all the neurotic phases, which psychologists connect with conditioning, or learning by instinct and reflex actions.

Eucrates I and his Electronic Trainer play a game. The teacher knows all the moves. Eucrates has to learn them. Once he has learnt a move he remembers it. "He" can also make a decision, whether right or wrong, just like a human being.

Eucrates and the Trainer have been developed by Mr. Gordon Pask with Mr. J. McKinnon Wood, and in association with The Solartron Electronic Group, Ltd., who own it.

An Electronic Process Timer

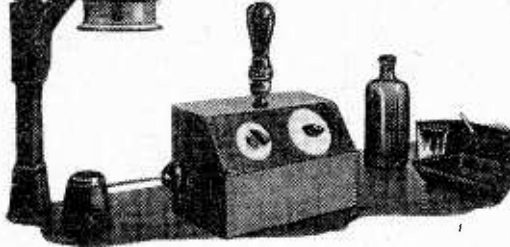

DESIGNED PRIMARILY AS A PHOTOGRAPHIC AID, THIS TIMER MAY BE FOUND USEFUL IN OTHER DIRECTIONS

By G. Chinchin

THE need of an accurate timing device for photographic work led to the construction of several electronic circuits published in various magazines, each one being abandoned for various reasons. Checking failures and requirements, the following points were borne in mind in designing a unit which could be modified quite easily at a later date, if necessary, for other uses.

1. Accurate repeat timing cycle.
2. No relay chatter (clean make-and-break).
3. Provision for adjustment of calibration due to ageing of components.
4. Cheap to build.
5. All parts readily available.

Eventually the circuit given in Fig. 1 was adopted, and has given good results for a period of two years. Unfortunately quality and cost rising in equal proportions has made this circuit a little more expensive in components than the other circuits employed originally but the results obtained justify the slight additional expense. All the components are available on the surplus market, the approximate cost being £2, excluding the cabinet.

No layout is given as it is not critical and can be built into any convenient cabinet. *The whole circuit, however, is "live" to the mains supply and suitable precautions must be taken, such as isolation of control knobs and switches. If a metal case is used it must be earthed.*

Referring to Fig. 1 which shows the basic circuit, S1 is the on/off switch and is used to switch the unit and external control circuit. C4 is used in place of the conventional "mains dropper" for the valve heater to minimise heat and enable a more compact unit to be made. A resistor could be used, and the value required for a 6.3 volt .3A heater on 220-230 volts mains would be approximately 740 ohms, but adequate ventilation should be given.

MR1 in conjunction with C1 is used to supply D.C. to the valve and control circuit, thus ensuring no relay chatter. Resistor network R2, R3, R4 supplies the cathode voltage, R3 being used to allow for component ageing.

Operation

The circuit is quite simple and straightforward. On switching on S1 the valve is heated via C4, MR1

COMPONENTS LIST FOR FIG. 1

RESISTORS

- R1—2 to 10 M Ω pot.
R2—0.1 M Ω , $\frac{1}{2}$ watt
R3—10 k pot, wire wound.
R4—5 k, $\frac{1}{2}$ watt.
R5—10 k, 1 watt.
R6—0.22 M Ω , $\frac{1}{2}$ watt.
R7—1 M Ω , $\frac{1}{2}$ watt.
R8—0.1 M Ω , $\frac{1}{2}$ watt.

CAPACITORS

- C1—8 μ F, elect., 350 volts D.C.
C2—4 μ F., 300 volts D.C.
C3—2 μ F. paper, 300 volts D.C.
C4—4 μ F. paper, 600 volts D.C.

- SL—Safe light.
Relay—2 to 5 k Ω .
Controlled A.C. Flush type 3-pin 2-amp. socket.
MR1—250 volts 30 m.A.
S1—S.P.S.T. toggle
S2—S.P.S.T. toggle
S3—S.P. 3-way.
S4—S.P. 2-way.
V1—EF50.

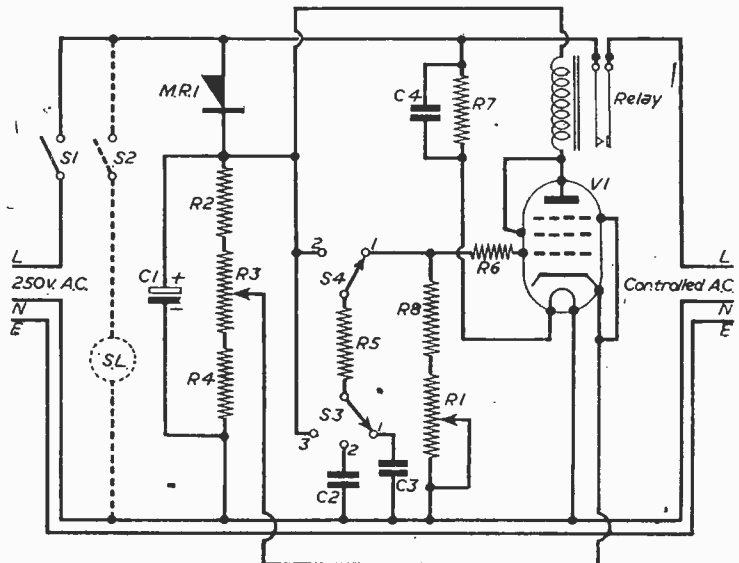

Fig. 1.—The basic circuit.

conducts, and an H.T. voltage of approximately mains value is developed across C1, R2, R3 and R4, which is fed to the anode of the valve via the relay coil. The cathode receives a positive voltage of 10-30 volts in respect to the grid, and thus the valve is cut off and the relay remains unenergised.

On moving S4 to position 2 (with S3 in position 1), the H.T. is applied via R5 to C3 which charges to the full H.T. value. R5 is used to prevent damage to capacitors and switch contacts due to surges if it were omitted. When S4 is returned to position 1 the grid becomes 200 volts or so positive to the cathode, allowing current to flow and energising the relay, thereby switching on the external circuit. R6 is included to limit grid current to a safe value. S4 is marked "reset" in position 2, and "operate" in position 1. However R1, R8 and R5 are now in series and connected across C3, allowing it to discharge at a rate depending on the value of the resistors, until the voltage is low enough to cause the valve to cut off, de-energising the relay and switching off the external circuit. R1 is, therefore, used as the "fine" timing control and is given a suitable dial. S3 is used to give the different ranges by switching into circuit different value capacitors: only two are shown but any number could be used. Additional ranges have been left to the individual constructor. With the values given times of approximately 1 to 20 secs. and 4 to 40 secs. are obtained. To prevent overlapping of the ranges a further resistor can be added in series with capacitor C2. For other ranges the formula $T=R \times C$ (where T =time in sec., R =ohms and C =farads) can be used, remembering to include R8 and R5 in the calculations.

When S3 is in position 3, S4 is by-passed and H.T. is applied continuously to the grid through R6, hence the controlled circuit remains on. This position is used for focusing the enlarger, etc. R8 in series with R1 is necessary to limit H.T. current should R1 be at minimum resistance when S3 is switched to position 3.

Components

Almost any relay can be used but one of 2 to 5 K. ohms is recommended and the contacts

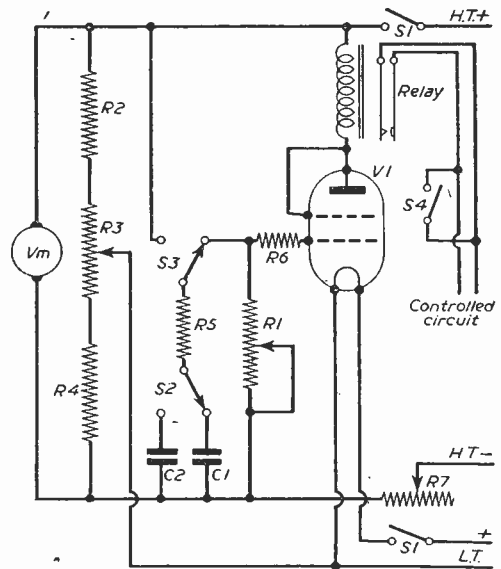

Fig. 2.—Battery version of the timer.

COMPONENTS LIST FOR FIG. 2

RESISTORS

- R1—2 to 10 M Ω pot.
- R2—0.1 M Ω , $\frac{1}{2}$ watt.
- R3—10 k Ω pot, wire wound.
- R4—10 k Ω , $\frac{1}{2}$ watt.
- R5—10 k Ω , $\frac{1}{2}$ watt.
- R6—0.22 M Ω , $\frac{1}{2}$ watt.
- R7—3 to 5 k Ω pot, wire wound.

CAPACITORS

- C1—2 μ F. paper, 200 volts.
- C2—4 μ F paper, 200 volts.
- Vm—Voltmeter
- Relay—1 to 3 k Ω .
- S1—D.P.S.T. toggle.
- S2—S.P. 2-way or as required.
- S3—S.P. 2-way.
- S4—S.P.S.T. toggle.

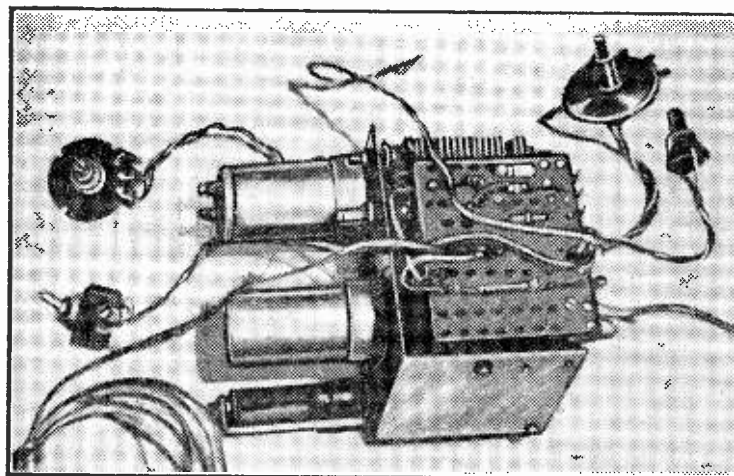

The timer removed from its cabinet.

should be open with the relay de-energised, also the contacts should be large enough to handle the current load that will be used. An EF50 valve is specified but almost any valve can be used, the only change required in circuit value is C4 if a valve of different heater rating is used. R7 should be retained at the same value, however, as it discharges C4 on switching off.

As the valve conducts during the "on" period only a battery version becomes a very economical proposition and a suggested circuit is shown in Fig. 2. MR1, C1, C4 and R7 can now be dispensed with, but S1 should be a 2-pole switch to prevent H.T. drain through R2, R3, R4. The LIT

can be switched off between operations and thus effect a further saving of battery life. Voltmeter V is included in the circuit, together with R7, to maintain the H.T. voltage at a predetermined level in the interest of calibration accuracy. An H.T. battery of 120 volts is suggested, and the resistor R7 used to about 70 volts (sub-relay operation) to relay de-energised. S4 in place of S3 position to further economise

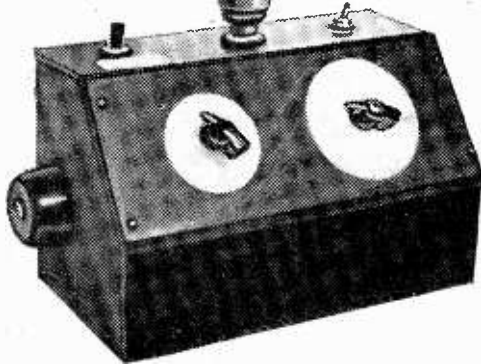

A general view of the timer.

Refinements

Other refinements which can be included are extra contacts on the relay to operate an indicator light to show that the relay has operated. This is useful if the external circuit cannot be "seen," or operates

apparatus at a remote point. This is shown in Fig. 3 (a) for mains, and 3 (b) for battery operation. A valuable aid in the photographic dark room is a safe light mounted on the unit itself; this enables the dial to be easily read and is shown in dotted lines in Fig. 1. For the calibration of the unit a clock or watch

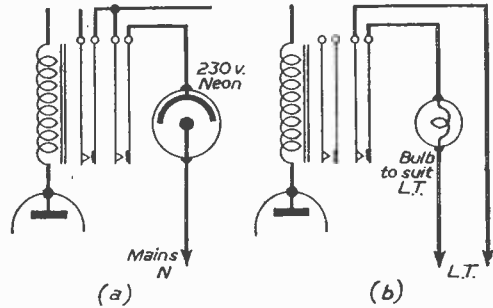

Fig. 3.—Relay connections.

with a large second hand can be used. Switch on and leave for a few minutes to warm up. Start with R3 in the centre of its travel, switch to range 1 and with R1 at its minimum value switch S4 to position 2 for a few seconds, then return to position 1, when the relay should operate. Now connect a low wattage bulb to the controlled circuit and operate the unit several more times and note the cycle time. This is marked on the dial or R1 adjusted until a suitable time, such as one second, is achieved accurately to mark on the dial. This process is repeated until the dial is completely calibrated. All further ranges can be calibrated in the same manner. Should the calibration shift after a period of time, R3 can be adjusted to correct this, and unless the change has taken place in individual range capacitors the correction will hold good for all ranges.

Listening Figures

JANUARY/MARCH, 1956

THE following table, issued by the BBC, shows that listening audiences were a good deal smaller in January/March, 1956, than in January/March 1955.

Average level of evening (6.0-11.0 p.m.) listening among the whole adult population of the United Kingdom (approximately 37,600,000 persons).

	% of the adult population
January/March, 1956	13.1
January/March, 1955	16.1

In January/March, 1955, it was usual for some 6,000,000 adults to be listening; a year later this figure had fallen to 4,900,000. This decrease in Sound audiences was principally due to the further spread of television which considerably reduced the number of adults with sound, but not TV receivers at home. Such people (the "Sound public") provide the bulk of listening audiences and their numbers fell from about 24,100,000 in January/March, 1955, to about 20,700,000 a year later.

The Sound public in January/March, 1956, besides being fewer in numbers, spent slightly less time in listening than did the Sound public in January/March, 1955, as the following analysis shows:

Average level of evening (6.0-11.0 p.m.) listening among the "Sound public," i.e., adults with sound, but not TV receivers.

	% of the "Sound public"
January/March, 1956	20.0
January/March, 1955	21.6

PRACTICAL TELEVISION JUNE ISSUE NOW ON SALE PRICE 1/3

The current issue of our companion paper PRACTICAL TELEVISION, now on sale, has constructional articles on a ten-element aerial, the conversion of the View Master for lower side-band working, and the conclusion of the details of the V.M. Tuner. Other articles in this issue deal with the long-range reception of Band III signals, further notes on C.R. Tubes, the new London Transmitter (adjusting receivers for the lower side-band system which the BBC have adopted for this transmitter), Improving I.T.A. converters, and the second article in the new series on Colour Television. Regular features such as Underneath the Dipole, Correspondence, Problems Solved and Telenevs, together with a further chapter on the Beginners Guide to Television complete the issue.

A Compact Stabilised High Voltage Supply

CONSTRUCTIONAL DETAILS OF SIMPLE BENCH SUPPLY

By Hugh Guy

(Continued from page 244, June Issue)

IN the case of transformers of unknown current output, a rough idea of their capabilities can be assessed from the cross-sectional area. Fig. 6a (last month) shows a stack of laminations and the widths of the stack and centre limb are marked. These dimensions, when multiplied together, give the core cross-sectional area. On a wound transformer the width of the centre limb is sometimes a little difficult to measure, particularly if the unit has been wax impregnated, but a little care and patience will soon yield the required width.

Very often commercial heater transformers are so economically designed that little is left in hand to permit even the slightest margin on the stated output. For this reason a figure of $\frac{1}{4}$ sq. in. area should be regarded as an absolute minimum, and more reliable results can generally be obtained using small Government surplus transformers, which are usually very conservatively rated.

Failing this, in certain cases it is permissible to remove up to five turns of the 6.3 volt winding on a lower-rated transformer in order to induce a large enough voltage in the other winding.

For the more enterprising reader complete winding and constructional details are given below for a suitable transformer should no other be available.

Transformer Winding Data

The laminations may be salvaged from an old speaker transformer or choke, and should be of the size given in Fig. 6b. They may be either "E" and "I" type or "U" and "T" type and a total stack depth of 1 1/16 in. is required. Slightly different-sized laminations may be used, but the same performance is not guaranteed and the bobbin size will have to be readjusted.

The bobbin should be made from stiff card, preferably Presspahn, conforming to the sizes given in Fig. 7. It should be punched with two slots to accommodate the start and finish flying leads.

The high voltage winding should be attempted first. This consists of 1,840 turns of 38 s.w.g. enamelled copper wire wound in neat layers of approximately 118 turns per layer. Thus, 16 layers will be required.

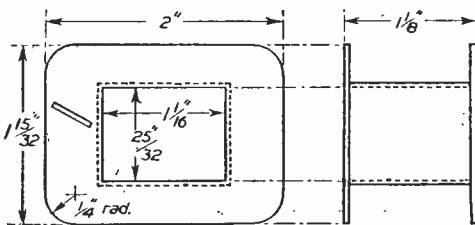

Fig. 7.—Details of the bobbins.

Between each layer, a single turn of thin tissue paper should be wound as insulation. Without this the enamel insulation may break down and short-circuit the winding.

In the absence of some sort of winding machine the process will be rather tedious, but nevertheless scramble winding should be avoided unless single silk-covered enamelled wire is used.

The winding should be started and finished by soldering to a thin insulated flexible wire, the joints being insulated in a fold of tape, which should be as neat and flat as possible to prevent a bulge in the winding.

Finally, three turns of paper should be wrapped round the completed winding to insulate it completely from the low voltage input winding which follows.

This is wound with 50 turns of 20 s.w.g. enamelled copper wire in three layers of 17 turns per layer. Once again each layer should be interleaved with paper, but the start and finish leads can be the wire itself, as 20-gauge wire is quite strong.

After securing the second winding with two or three turns of paper and tape the transformer may be assembled, interleaving the laminations.

The finished job may now be tested by connecting the high-voltage winding to the A.C. mains when approximately 6.5 volts A.C. will be induced at the output.

This transformer is, therefore, quite suitable as a heater transformer and may be used as such quite independently of the design described in the remainder of this article if so desired.

Rectifiers

It is essential that the output from such a transformer is rectified by a full-wave system as opposed

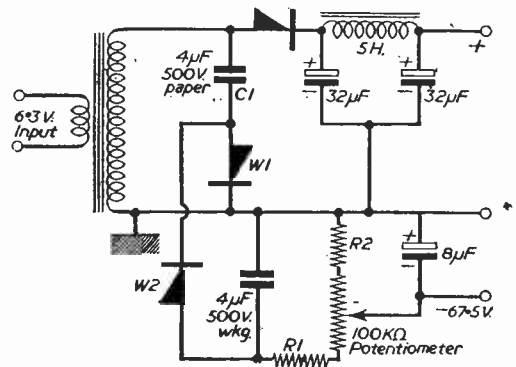

Fig. 8.—A half-wave power supply developing -67.5 volts.

to a half-wave system. This is a very important point which few constructors realise; quite often the mistaken idea exists that a transformer which delivers, say, 350-0-350 volts can be used in conjunction with a half-wave rectifier to deliver 700 volts D.C. at the current that the winding is stated to supply under full-wave conditions. This is definitely not so since a half-wave connection causes a half cycle of direct current to flow in the winding. This has the effect of biasing the core which will then saturate at much lower currents drawn from the transformer, decreasing the output voltage and overrunning the primary.

If, however, the laminations are so stacked that all the "Es" are together and all the "Is" are together, and a piece of packing is arranged to separate the laminations when they are assembled around the transformer, thereby providing a high reluctance path in the magnetic circuit, then the winding will operate under half-wave conditions, albeit with lowered efficiency. This is the procedure adopted with A.F. power output transformers which have to carry the direct anode current as well as the alternating signal current which is passed to the loudspeaker.

Selenium rectifiers are sometimes available with a centre tap, in which case only two will be required rated end to end at 240 volts 60 mA. These two will be rectifiers 1a and b, and 2a and b, on the circuit of Fig. 4. Alternatively four of the 120 volt 60 mA rectifiers may be used. The use of valve rectifiers is rather uneconomical here as at least two would be required and the additional heater current necessitated makes this arrangement undesirable.

The customary reservoir and smoothing condensers C1 and C2 can be combined in the one electrolytic type, while the value of the choke is not critical, 5H being quite adequate.

Internal Bias Supply

It was mentioned earlier that it might be possible to incorporate the bias supply in the unit by developing the required voltage internally.

This arrangement will only be possible if a half-wave type of rectification is used, and in turn this is only permissible if the transformer conforms to the restrictions outlined above.

This condition having been satisfied, the circuit of Fig. 8 may be used. Here we see that the reference voltage is supplied by a voltage doubling network C1, W1 and W2, which provides a negative direct voltage output of approximately 450 volts. This must now be attenuated by the resistance chain R1

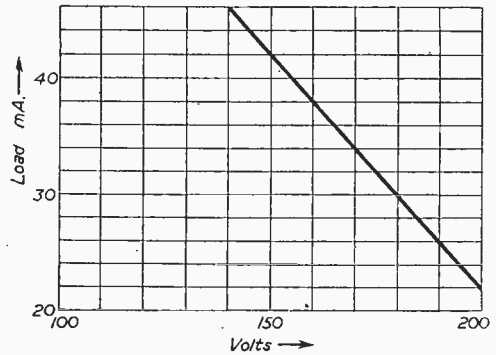

Fig. 10.—Maximum load for 1 per cent. variation of output voltage.

and R2 at the junction of which 67.5 volts must be available. To achieve this a variable control is connected in series with R1 and R2. This is necessary due to the unpredictable nature of the variety of transformers that may be used in practice. Having found the correct "on-load" reference voltage, however, this will remain quite stable, as the total load current supplied by the transformer is constant, and hence only heating effects, apparent during warm-up, will cause the output voltage from the stabiliser to vary.

Final Circuit

The finishing touch to the complete unit is provided by the incorporation of a fuse, on/off switch, and voltmeter. The fuse may be connected in either the low-voltage winding or after the rectifiers in the other winding. If in the former position, a 5 amp. fuse will

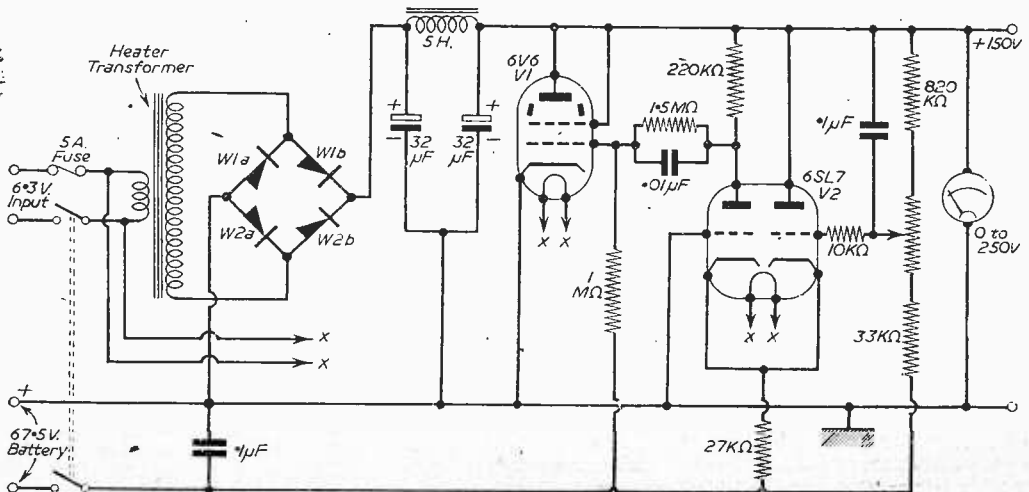

Fig. 9.—The final circuit.

suffice, whilst if in the alternative position a 100 mA fuse should be used.

The final circuit assumes the use of the battery-type reference, in which case it is advisable to provide one pair of contacts on the main on/off switch to disconnect the battery when the unit is switched off. This will call for a two-pole single-throw toggle switch, and the connections for it are shown in the circuit of the final arrangement (Fig. 9).

The meter that is used should read to 250 volts D.C. and should preferably be of the moving-coil variety, since these do not draw any appreciable current in operation.

If the use of a meter is regarded as an unnecessary luxury, it is possible to draw a scale to fit round the voltage control, a pointed knob being fitted to the latter. The scale will then read volts output, having previously been calibrated with the aid of a voltmeter.

The provision of an additional meter to monitor the current is optional, but has not been included in the final circuit.

Constructional Notes

The unit can be assembled quite easily on a chassis measuring not more than 5in. by 5in. and about 1½in. deep. A metal front panel should be screwed to the chassis to accommodate the input and output terminals, the control potentiometer, the fuse, and meter, if one is used. This panel need not exceed 5in.

square, and thus the whole unit will be a cube of 5in. side.

There is nothing critical in any of the wiring, but a reasonably heavy gauge earth bus-bar should be used (e.g., 16 s.w.g.).

When mounting the unit in a cabinet, adequate ventilation should be provided, as lack of free circulating air can be one of the chief causes of drift in the unit.

Performance

The prototype unit has a ripple voltage of less than 10 millivolts on load. This figure is far better than that normally available at the decoupled point in an amplifier, and therefore no hum troubles should be feared from this source. The output impedance is about 10 ohms from no-load to full load, and therefore it is possible to test several high-gain devices at once without fear of positive feedback through the H.T. supply and consequent instability.

A graph has been prepared showing the maximum load current that can be drawn for any output voltage between 140 and 200 volts for only a 1 per cent. variation of output voltage when the current is varied from no-load to this stated load.

These performance figures are largely due to the stabiliser section alone, and therefore similar results can be expected if the stabiliser is fed by some alternative power unit, provided the precautions outlined earlier are observed.

Long-play "Emitape"

THE new Long-Play Emitape recording tape "99" made its first appearance at an exhibition on the E.M.I. Sales and Service Stand (No. 12) at the Exhibition of the British Sound Recording Association at the Waldorf Hotel on May 26th and 27th.

Introduced as a companion to the well-known "Pen-Tested" Grade "77" (the choice for all professional recordings) and the General Purpose Grade "88," the new "99" is a specially developed thin P.V.C.-base tape giving a 50 per cent. increase of recording time for the same spool size. Its magnetic-oxide coating and electrical characteristics are identical with the high sensitivity "88" and "77" tapes, and it possesses the same outstanding features of low head wear, freedom from curl, negligible elastic elongation, and very low noise-level which have caused Emitape to be adopted as standard on the majority of tape recorders manufactured in this country; and the preferred choice of scientists and technicians in industry, scientific establishments and broadcasting organisations throughout the world.

Emitape is also used for "His Master's Voice," Columbia and Parlophone recordings, for "His Master's Voice" and Columbia single-channel and "Stereosonic" tape records, and by many other recording companies.

A new spool size—the 5½in. "Continental"—has been added to the Emitape range to satisfy the home and overseas markets. This new plastic spool has a capacity of 850ft. of Emitape "88," or 1,200ft. of Emitape "99." Playing times at 7½ in./sec., are 45 and 64 minutes respectively on twin-track recorders.

This brings the range of Emitape spool sizes to six.

V.H.F. Campaign by BBC

AUDREY RUSSELL, one of the best-known woman reporters for the BBC, has been playing a part in the BBC campaign to remind people of the advantages of V.H.F. sound reception. She spent three days (April 30th—May 2nd) touring part of the Sussex coast area recording short interviews with people who listen to the BBC on V.H.F. Some of these interviews may be broadcast during breaks between programmes as a reminder to people that reception on V.H.F. is virtually free from interference and more lifelike than medium wave in its sound quality.

Miss Russell was greatly helped by Mr. A. G. Spicer, Chairman of the Brighton branch of the R.T.R.A., and by many local radio dealers. She took recordings from people in Worthing, Chichester, Tangmere, Brighton, Hove, Eastbourne and Battle—all areas where foreign interference is intense. She interviewed dozens of people, some well known, like Douglas Reeve (the organist at the Dome at Brighton), and some with no claim to fame. There was a mechanical engineer, several radio salesmen, a saddler, a postman, a headmaster, a clergyman, a solicitor, a clinical research worker and people in many other walks of life. The basic story was the same—that V.H.F. had made it possible to listen with real pleasure, whereas previously interference had taken most of the pleasure out of listening.

One man said to Miss Russell: "When I listened to you on my old set I always thought you were a brunette. But on my V.H.F. set I found I could visualise you more clearly, and I felt sure you were a blonde." He was right. On the anniversary of the opening of the V.H.F. station at Wrotham, the BBC gave a demonstration of V.H.F. to music critics.

PREMIER RADIO COMPANY

B. H. MORRIS & CO., (RADIO) LTD.

OPEN TILL
6 P.M. SATURDAYS

(Dept. P.W.) 207, EDGWARE ROAD, LONDON, W.2

Telephone :
AMBASSADOR 4033
PADDDINGTON 3271-2

BUILD THESE NEW PREMIER DESIGNS

3-BAND SUPERHET RECEIVER

MAY BE BUILT FOR **£7.19.6** Plus 3/- Pkg. & Carr.

Latest type Superhet Circuit using 4 valves and metal rectifiers for operation on 200-250 volts A.C. mains. Waveband coverage—short 16-50 metres, medium 180-550 metres, and long 900-2,000 metres. Valve line-up 6K7 req. changer, 6K7, 1F, 6Q7. Detector AVC and first AF. 6V6 output. The attractive cabinet to house the Receiver size 12in. long, 6 1/2in. high, 5 1/2in. deep can be supplied in either WALNUT or IVORY BAKELITE or WOOD.

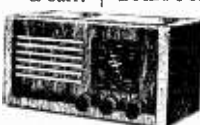

TRF RECEIVER

MAY BE BUILT FOR **£5.15.0** Plus 3/- Pkg. & Carr.

The circuit is the latest type TRF using 3 valves and Metal Rectifiers for operation on 200-250 A.C. mains. Wave band coverage is 180,550 metres on medium wave and 100-2,000 metres on long wave. The dial is illuminated and the Valve line-up is 6K7 H.F. Pentode 6J7 Detector and 6V6—Output.

illuminated and the Valve line-up is 6K7 H.F. Pentode 6J7 Detector and 6V6—Output.

4-WATT AMPLIFIER

MAY BE BUILT FOR **£4.10.0** Plus 2/6 Pkg. & Carr.

Valve line-up 6SL7, 6V8 and 6X5, FOR A.C. MAINS 200/250 VOLTS. Suitable for either 2-ohm or 15-ohm Speakers. Negative feedback. Any type of pick-up may be used.



Overall size 9 x 7 x 5in. Price of Amplifier complete, tested and ready for use, £5.5.0 plus 3/6 pkg. and carr.

INSTRUCTION BOOKS 1/- each (post free) which includes Assembly and wiring diagrams, also a detailed Stock List of priced components.

CABINETS—PORTABLE

Model PC 1

Brown Rexine covered, 15 1/2in. Overall dimensions 15in. x 13 1/2in. x 5in. Clearance under lid when closed 2 1/2in.

Model PC 2

Grey Lizard Rexine covered, 45 1/2in. Overall dimensions 15in. x 13in. x 6in. Clearance under lid when closed 3in.

Model PC 3

Rexine type covering in various colours, 69.6.

Overall dimensions 16 1/2in. x 14 1/2in. x 10 1/2in. Clearance under lid when closed 6 1/2in. All the above Cabinets are supplied with Panel Carrying Handle and Clips. Packing and Postage 2/6.

Send for details of the Premier Wide angle Television design which may be built for £30.

ALL-DRY BATTERY PORTABLE RADIO RECEIVER

4 miniature Valves in a Superhet Circuit covering medium and long waves. Rexine covered Cabinets 11in. x 10in. x 5 1/2in. in two contrasting colours. Wire with Grey Panel, please state choice when ordering. **THE SET MAY BE USED EVERYWHERE—home, office, car or holidays.** INSTRUCTION BOOK, 1/6 (Post Free) which includes Assembly and wiring detailed Stock List of priced components.

MAY BE BUILT FOR

£7.8.0

Plus 2/6 Pkg. & Carr.



A Range of High Fidelity Amplifiers, Speakers and Record Players by the following makers in stock : Leak, E.A.R., Rogers, Goodmans, Wharfedale, W.B. Stentorian, Larenz, B.S.R., Collard, Garrard, Lenco, Cornholmeur. We shall be only too pleased to demonstrate any of the above equipment.

B.S.R. Monarch 3 speed Autochanger **£7.19.6**, postage and packing 5/-.

3 Speed single player with crystal tune wheel **£6.19.6**, postage and packing 5/-.

data for AUDIOPHILES*

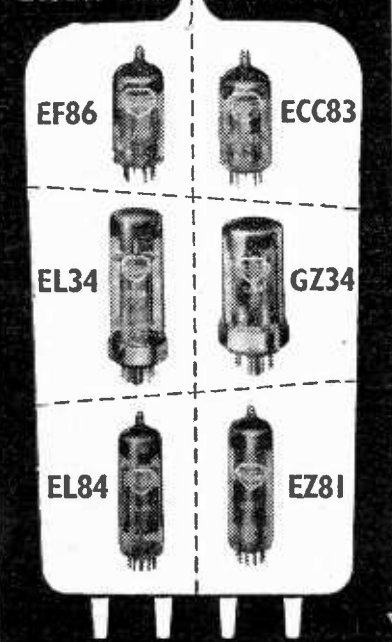

Audiophiles all over the world are demanding Mullard audio valves for their high quality sound equipment. And who can blame them when they know that the Mullard World Series of Audio Valves is the finest in the world. Fill in the coupon below for free data on Mullard World Series Audio Valves.

* *Audiophile—Enthusiast for high quality sound reproduction who is satisfied with nothing but the best.*

This popular book is available now from most dealers, price 3/6d. It contains designs and full constructional details of the new Mullard EL34 High Quality 20 Watt Amplifier, a Mullard Band II F.M. Tuner, pre-amplifiers for the Mullard EL34 Amplifier and for the popular Mullard 5 Valve 10 Watt Amplifier, together with other useful technical information.



Mullard

WORLD SERIES
AUDIO VALVES



Mullard Ltd., Publicity Division,
Century House, Shaftesbury Av.,
London, WC2

COUPON

To Mullard Ltd., Publicity Division
Please send me, free of charge, leaflets on the Mullard World Series of Audio Valves, and details of "High Quality Sound Reproduction".

NAME

ADDRESS

Taylor

**Sturdy—Versatile—
Pocket-size!**



JUNIOR UNIVERSAL METER

Model 120A

A small 19-range instrument ideal for the enthusiastic amateur. Sensitivity is 1,000 o.p.v. A.C. and D.C. Accuracy: 2% D.C.; 3% A.C.

RANGES

Volts D.C. 0-25-10-50-250-500-1,000-2,500.
Volts A.C. 0-10-50-250-500-1,000-2,500.

Milliamps D.C. 0-1-10-50-500-5,000.
Resistance 0-2,000 ohms, 0-200,000 ohms.
Can be extended to 20 megohms. Automatic overload. Protection fitted to meter movement.

PRICE £9.15.0. PROMPT DELIVERY

CREDIT TERMS: Nine monthly payments of £1.0.8.

HIRE PURCHASE TERMS ALSO AVAILABLE.

★

All Taylor instruments available on 7 DAYS' APPROVAL and 9 monthly credit terms.

UNIQUE OFFER!

You can part-exchange an old TAYLOR instrument for a new one—write for details.

TAYLOR ELECTRICAL INSTRUMENTS LTD.

Montrose Avenue, Slough, Bucks.
Telephone: Slough 21381
Cables: Taylins, Slough

DIRECT FROM THE MANUFACTURER

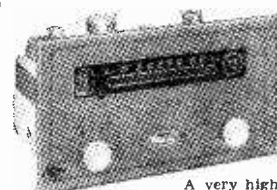

**F.M. (V.H.F.) TUNER
CHASSIS COMPLETE
AND SELF POWERED
ASSEMBLED AND
READY FOR USE**

A very high quality instrument designed for use in conjunction with Radiograms, Receivers with Pick-Up Sockets, Tape-Recorders and Quality Amplifiers. **£17.10.3** inc. tax

- Switching is incorporated for direct intercommunication.
- Circuit comprises Permeability tuned superheterodyne with R.F. Stage and additive mixer.
- Dial—Full View Perspex Dial size 10½ x 5½. Incorporating all modern features in Latest Design and Technique and quality components.

COMPLETE CHASSIS

Model H.4. 4 Wavebands, including F.M., 7 Valves with latest miniature Cathode Ray Tuning Indicator. **£27.16.0** inc. tax

Model F.3. 3 Wavebands, 5 Valves, 4 watt output, wide range tone control. **£14.11.11** inc. tax

Model F.3.P.P. 3 Wavebands, 7 Valves, 6 watt output, with "Push Pull" stage. Separate Bass and Treble controls. **£18.15.4** inc. tax

ALL GOODS FULLY GUARANTEED

ALL ABOVE CHASSIS ARE ASSEMBLED AND READY FOR USE AND BUILT TO HIGHEST TECHNICAL STANDARDS.

Write also for details of Tape Recorders, and Crystal Receiver/Tuners.

We have designed and approved a **PRE-AMPLIFIER** for the new **COLLARO** Tape Transcriber.

Dulci COMPANY LTD.

97, VILLIERS ROAD, LONDON, N.W.2.

Telephone: WIllesden 6678.

Best Buy at Britain's

RESISTORS. Latest miniature insulated Dubilier 1 watt type BTS. Wire ends. Useful values. ONLY 10- for 100 assorted!

FIELD TELEPHONES. Army type D. Mk. 5. Buzzer calling. Ideal for building sites, farms, workshops, etc. Complete with handset and batteries. Tested before despatch. 39 6 each.

MILLIARD RESISTANT-CAPACITY BRIDGES GM-4140-1 1 ohm to 10 Megohms and 10pFd to 10 mFd. For 110 and 230 v. A.C. mains. Used, but in perfect working order. £5.19.6d.

COMMAND RECEIVERS. Complete with 6 metal valves, 3 12SK7, 1 12K8, 1 12SR7 and 1 12A6. Size 5 in. x 5½ in. x 11½ in. deep. In very good condition. Less dynamotor. FREE CIRCUIT WITH EACH SET.

BC455, 6-9 Mc s. 25-. BC453 (the famous Q5'er), 190-550 Kc's. 59 6.
BC454, 3-6 Mc s. 27 6. BCXXX ("Trawler" band), 1.5-3 Mc s. 65 -.

RECEIVERS TYPE R1155.—In excellent condition, thoroughly checked and air-tested. These first-class communications receivers are available from £5.19.6, according to condition. Send S.A.E. for particulars or 1/3 for comprehensive booklet.

A.C. MAINS POWER PACK & OUTPUT STAGE.—These enable the R1155 to be used on the mains WITHOUT ANY MODIFICATION. Three types available, £4.10.6, £3.5.0 and de-luxe model with 8 in. speaker, £6.10.0. Carriage 5-.. All Power Packs guaranteed six months.

DUAL VOLTAGE BLOWERS.—12 and 24 v. Ideal for hair dryers car heaters, etc., 25- plus 2/6 postage.

TRANSFORMER BARGAINS. Brand new ex-manufacturer's surplus drop through. Primary 200-250 volts 50 cps. Secondary 310-0-310 v. 70 mA., 6.3 v. at 3 a., 4 v. at 2 a. Can be used with either 4 v. or 6.3 v. rectifier. Only 9 6. A similar type transformer 325-0-325 100 mA., 6.3 v 4 a., 4 v. 3 a., 12 6. Add 1/6 postage for either.

MINIATURE MODEL MOTOR.—2 in. long x 1½ in. diam. 1/3½ in diam. spindle, weight 5 ozs. Will work from 6-volt dry battery and are reversible. Ball bearings. Price 8 6.

METER RECTIFIERS.—1 mA. Salford Instruments. 8 6. 2 mA. S.T.C. as used in E.M.I. Output Meter. 5 6. All full wave bridge and brand new.

METAL RECTIFIERS.—250 volts, 100 mA. 6/9 each. 230 volts, 60 mA. 5- each.

CHARLES BRITAIN (RADIO) LTD.

11, Upper Saint Martin's Lane, London, W.C.2.

TEmple Bar 0545

Shop hours 9-6 p.m. (9-1 p.m. Thursday) Open All Day Saturday



On Your Wavelength

BY THERMION

Old Receivers

I HAVE been quite astonished at the number of letters I have received from readers offering to loan me home-constructed receivers going back to the '20s and early '30s, in response to my recent note on this subject. One reader who built a well-known reflex circuit disagreed with my criticisms of it. He says that he obtained quite satisfactory results. That was not my experience. The thing burst into violent oscillation, was thoroughly unstable and suffered from all the usual defects of trying to make one valve do more than it was designed to do. In those days many stunt circuits were put out under fancy names, the claims made for which could not really be substantiated, but then, also in those days, people were prepared to put up with bad reception and bad performance because radio had not advanced to the point where they knew what good reception should be. Now we have a yardstick. I wonder how many of the owners of these old receivers if they connected them up today would speak of them in the same eulogistic terms as they did when they first built them?

However, if the exhibition organisers are interested, I shall take advantage of the kind offer of these readers to borrow their receivers for exhibition at the next radio show.

Our stand, by the way, is No. 111, where all readers will be welcomed. Make a note of it.

Car Radio

A REMINDER that when applying for a Road Fund licence you are not compelled to fill in that line on the form which enquires whether the car is fitted with a radio, and a licence cannot be refused if you omit to do so. You must, of course, take out a licence for the car radio, but it is up to the Post Office and not the Ministry of Transport to ascertain whether you have a licence. A car radio is defined as one which is a fixture in the car. If you own an ordinary portable receiver and use it in the car a separate licence is not necessary, as an ordinary receiving licence permits you also to own a portable.

Oak Trees from Little Acorns

ANOTHER reader reminds me that he can remember the genesis of PRACTICAL WIRELESS which originally appeared as a supplement to the weekly journal *Hobbies*, of which Mr. F. J. Camm was then the Editor. This was in the early '30s and it soon became apparent that the reader interest in the subject of radio could not be satisfied with a weekly supplement, and so P. W. was born. Some of the receivers which we described in that journal were quite good for their day. There was one, a Reinartz, which was extraordinarily good, and there was another—the Baby Grand—which was built into a cabinet of the shape of a miniature grand piano. It was a detector-2LF circuit, but the quality of reproduction was quite magnificent even though the selectivity was poor.

Full Mains Voltage Valves

INCIDENTALLY, one reader possesses one of the early receivers which I designed, that incorporated the Oster Ganz full mains voltage valve which, of course, is no longer on the market. Such valves offered distinct advantages in that they eliminated the need for several components, including the mains transformer, a most expensive item, and the reception was quite good. It was, however, not possible entirely to eliminate mains hum, and on the whole the disadvantages outweighed the advantages.

Speaking of full voltage mains valves, I recall one of the greatest jokes in radio journalism. A constructor's paper (not, of course, PRACTICAL WIRELESS!) put out a design making use of a D.C. receiver and claiming that it was free from hum; needed no mains smoothing condensers, and that it could be built for about half the price of a normal type using low voltage valves. Demonstrations in the office of the journal concerned gave pure reception free from hum. None of the unfortunate readers, however, who built this receiver could duplicate these results, and complaints were received by the hundred. The "designer" was naturally worried and so was the editor of the paper concerned, who should have known but who apparently did not know that the electricity supply in the building concerned, was from a bank of accumulators!

This same journal created quite a hoo-ha with a design for a so-called loudspeaker crystal set, which incorporated for its "amplifier" the Skinderviken transmitter button. It was possible under laboratory conditions by means of this device to increase reception beyond earphone strength. The periodical concerned waxed so enthusiastic about it that it actually published a book explaining how to build loudspeaker crystal sets. This was in the early 'twenties, when crystals were very much in vogue. Of course, none of the receivers worked, and letters of criticism from clamorous readers poured into the offices. It was, of course, good for the sale of transmitter buttons!

Printed Circuits

NOTICE that many more manufacturers of radio and electronic apparatus are now making use of printed circuits. This should eliminate all possibility of assembly errors and, therefore, cheapen the cost of inspection and rectification. Perhaps we can hope that as a result some of the benefits will be passed on to the consumer in the form of lower prices. I have not noticed any downward tendency although the rise in the cost of material and labour, no doubt, has offset the advantage. I should like to see a component manufacturer put out sets of parts for coils and other wireless components based on this principle. The process at present is, of course, dearer than an ordinary blueprint, but no doubt one day instead of receiving a blueprint, you will receive a printed circuit!

Using TEST INSTRUMENTS

Part 17 of a Series of Articles
Dealing with the Practical Application
of Standard Test Equipment

(Continued from page 238 June issue)



The Grid-Dip Oscillator (continued)

AS we have already seen, it is normal practice to arrange the mounting of the coil so that it can easily be held in fairly close proximity to the tuned circuit under test. By this means the energy in the coil of the grid-dip oscillator is transferred to the circuit under examination, and maximum energy is imparted to the test circuit, indicated by the greatest dip in the grid current meter or magic eye valve, when the oscillator frequency equals the resonant frequency of the test circuit.

It is sometimes found more convenient to use a different method of coupling the oscillator of the instrument to the test circuit. A method which works very well indeed is shown at Fig. 78. Here a coupling coil is wound on the same former as the coil comprising part of the tuned circuit of the instrument. This coil is terminated at a coaxial socket which is conveniently situated on the case. A coaxial link then conveys the oscillator energy, via the coupling coil, to a testing loop. A coaxial plug fixed on one end of the link provides a simple means of connection to the instrument. Operation is essentially the same as hitherto, but now, instead of bringing the actual coil to the circuit to be examined, the testing loop is used. Where the external circuit itself features a coil, in order to achieve an optimum degree of coupling the testing loop is best held completely over the coil.

The number of turns required on the coupling coil and testing loop depends, of course, on the frequency spectrum embraced by the particular oscillator coil in use. From 30 to 70 Mc/s two turns are generally found sufficient; above 70 Mc/s and up into Band 3 frequencies one turn is all that is necessary. Below 30 Mc/s the number of turns will have to be increased, probably ending up with 40 or 50 on the long waveband.

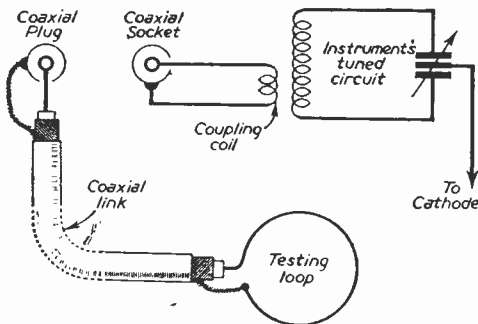

Fig. 78.—The use of the coupling coil.

It really boils down to the fact that the coupling coil provides a low impedance output from the oscillator, and it is best to arrange the impedance here to match reasonably well into 75-80 ohm coaxial feeder. When this is achieved a fairly long link can be used without the fear of impairing the

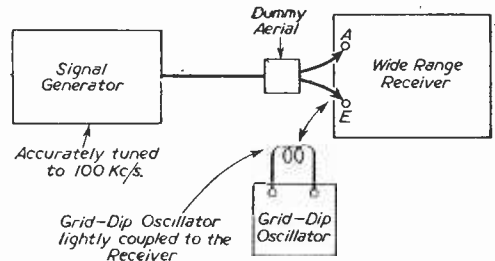

Fig. 80.—A much more accurate method of calibration is possible by using a wide range receiver and a signal generator.

efficiency of the instrument.

The fact that a low-impedance output is available means that any tuned circuit which also has a low or similar impedance coupling can be connected direct to the instrument. For example, if one is keen to know the resonant frequency of a television aerial it is simply necessary only to connect the aerial feeder to the coaxial socket, plug in the correct coil, and adjust the tuning for maximum dip on the indicator. By this means the aerial can be checked *in situ*.

Calibration (61)

When calibrating or using a grid-dip oscillator it must be remembered that essentially it represents a low-power transmitter and that it is liable to cause severe pattern interference on near-by TV receivers and whistles on broadcast receivers when tuned to the frequencies or sub-harmonics of the frequencies concerned. Owing to the relatively wide vision bandwidth of TV receivers, pattern interference is the most serious possibility, and for this reason it is best to use the instrument in the V.H.F. ranges outside TV programme hours.

One of the most satisfactory methods of completely calibrating a newly built instrument is lightly to couple it to a communications type receiver or an all-wave broadcast receiver, and then adjust the instrument and the receiver so that the oscillator's carrier is heard, which will probably be slightly modulated at 50 c.p.s. (mains frequency). It is not difficult to pick out, as it normally blocks the receiver completely, but a visual indication is available on sets

featuring an "S" meter or magic eye. On sets not endowed with these refinements a visual indication can be obtained by measuring the A.V.C. voltage either directly, with a voltmeter of high sensitivity, or indirectly by measuring the cathode current of one of the A.V.C. controlled valves. This method is shown at Fig. 79.

Such a method of calibration cannot, of course, be entirely accurate, for rarely does one find a receiver, even a communications receiver, whose alignment holds according to the tuning scale over all wavebands. As an aid in determining the precise frequency setting, however, the receiver can be tuned in to a station of known frequency and the grid-dip oscillator adjusted to the same frequency. When

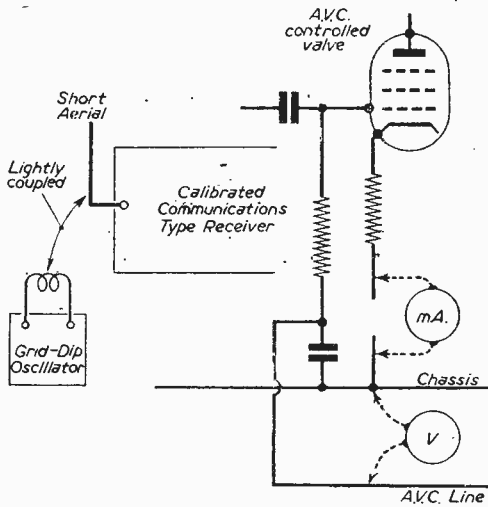

Fig. 79.—A simple method of calibration.

this state exists a whistle will be heard from the loudspeaker, as the two signals heterodyne (beat).

This method of calibrating a grid-dip oscillator to the television sound and vision frequencies works very well indeed. The TV receiver can, of course, then be used instead of the communications or broadcast receiver. It is best simply to use the TV in the usual way with the aerial properly connected and position the grid-dip oscillator some feet away. The beat note on vision can be heard by connecting a pair of 'phones, via suitably valued and rated isolating capacitors, between receiver chassis and tube cathode (or grid, in the case of grid modulated tubes). We must stress again that this must be done outside programme hours, preferably during the 30 minutes or so before the morning test transmission, for at this time a sound and vision carrier is invariably radiated but is not modulated, so that it is of little use for normal receiver test purposes.

As a means of providing a really accurate method of calibration with a broadcast or communications receiver the use of an accurately calibrated signal generator is essential. The generator can then be

used to produce a signal, which is picked up by the receiver together with the signal from the grid-dip oscillator, and adjustment made by tuning the instrument or signal generator to give a dead beat in the set's loudspeaker. In effect, of course, the grid-dip oscillator is being tuned to beat against the calibrated signal generator, and the receiver is simply acting as a detector of the beat note.

By using a wide-range receiver and a signal generator, which can be modulated, a means is available of providing marker points for calibration purposes spaced at 100 kc/s. The procedure is as follows: Tune the receiver to the L.W. Light Programme, disconnect the aerial and earth and in place apply the output leads, preferably via a dummy aerial, of the signal generator. Next, tune the signal generator to 100 kc/s and switch on the modulation. Now, the second harmonic of the generator at this frequency is, of course, 200 kc/s, and this will be picked up on the receiver when the generator is accurately tuned to 100 kc/s. Subsequent harmonics of the 100 kc/s generator signal will be picked up on the receiver as it is tuned over the various ranges, though higher order harmonics may be very weak, necessitating a high input signal and a high receiver gain setting. Nevertheless, the 100 kc/s marker points can generally be heard right up to the high-frequency end of the short waveband.

Clearly, then, it is necessary now simply to tune the grid-dip oscillator to zero beat at the required marker points within range of the coil in use, and carry out the calibration either direct on the grid-dip oscillator's tuning scale or on a graph corresponding to degrees on the scale (see Fig. 80).

As an aid in establishing the precise dead-beat setting the generator's modulation should be switched off once the required 100 kc/s marker point has been picked up on the receiver. Here we should mention a word of warning regarding second channel or spurious responses of the receiver itself. If the receiver used for calibration does not feature a stage of R.F. amplification or if it has only one R.F. stage, there exists a possibility that the second-channel frequency may give rise to a substantial response from the signal generator. Care should, therefore, be taken to avoid confusing such a spurious response with the true frequency.

Calibrating by Means of Lecher Wires (62)

Now that Band 3 TV is under way the sound and vision signals of Channels 8 and 9 can be used to provide at least two calibration points at the top end of the V.H.F. spectrum. The procedure, of course, is the same as that described in the first part of this article.

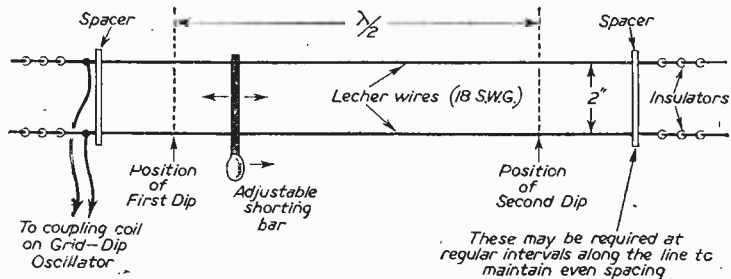

Fig. 81.—The use of Lecher wires facilitates calibration at very high frequencies.

If one does not happen to possess a Band 3 (two-band) TV receiver or is outside the Band 3 transmission zone, then other methods will have to be adopted to aid in calibrating the grid-dip oscillator at the very high frequencies.

One successful method is to determine the frequency of oscillation of the grid-dip oscillator by actually measuring the length of the generated waves. This is done by causing the instrument to energise a specially constructed transmission line, the length of which can easily be varied by means of a shorting bar. The transmission line, or Lecher wires, as it is sometimes termed, consists of two parallel wires spaced 2in. apart. Number 18 s.w.g. tinned copper wire is the best material to use to form the transmission line, and it is essential that the lines be set up well clear of any metal object which may influence the line resonance. The wires should be very tightly supported by insulators at each end. It is also essential that the spacing remains equal along the entire length, and to aid in this respect insulated spreaders are often

needed on relatively long runs (see Fig. 81).

The wires are energised by connecting one end across the coupling coil on the instrument's oscillator coil, the overall length of the line is then adjusted by sliding a shorting bar along the wires away from the connection to the grid-dip oscillator. Provided the wires are within the frequency range of the instrument, a pronounced dip in grid current will be observed a little distance away from the point of connection. This position on the line should be clearly noted, and the shorting bar moved in the same direction of travel until a second dip occurs; this position on the line should also be noted.

Now, as shown at Fig. 81, the distance between the two positions noted is equal to half a wavelength of the applied energising frequency, and in order to find the frequency related to the distance in inches the following expression can be used: Frequency in Mc/s = 5905/distance in inches, or distance in inches = 5905/frequency in Mc/s.

(To be continued.)

Printed Circuits

WITH the continuing development of printed circuits, T.C.C. have produced a bulletin dealing with surface coatings, finishes and notes on dip soldering from which the following extracts are taken, as it is thought that they will interest readers in the latest developments in printed circuit technique. Experience in the production and use of printed circuits has confirmed the desirability for providing the circuits with a surface protective coating to maintain the copper surface free of oxidation and thereby retain its solderability. T.C.C. printed circuits are supplied coated with surface preservatives of a type to suit customers' particular requirements, the choice of surface coating depending on the method of assembly and soldering of the printed circuits.

With the surface of the copper protected and in a clean solderable condition it is still necessary to use a flux when dip soldering. Suitable fluxes specially formulated for dip soldering are recommended and when used in a two-bath method in conjunction with the T.C.C. flowing wax, then extremely reliable and consistent results may be obtained.

Maintenance of a Clean Copper Surface

To ensure that the surface of the printed circuits does not deteriorate following processing and storage and is maintained in a good clean solderable condition, it is essential to prevent oxidation occurring. This is best done by the application of a surface coating which must be homogeneous, impervious to atmospheric conditions and should assist in the soldering operation. Two types of surface preservative are normally recommended, each of which has been found to give a satisfactory performance over long storage periods.

Dip Soldering of Printed Circuits

It is frequently pointed out that one of the greatest advantages in the use of printed circuits, is that the possibility of dip soldering may be realised. To ensure effective and reliable dip soldering it is essential that care is taken in the maintenance of the surface of the printed circuits. It is also, of course, essential that all the components which are to be assembled on the printed panel should also be in a good solder-

able condition, free from dust, grease or other contaminants. The following notes describe the recommended process.

The optimum soldering temperature is 235 deg. C. to 240 deg. C. It is essential that the bath should be adequate in size, allowing 2in. to 3in. on all sides of the panel. A depth of 1½in. to 2in. of solder should be the minimum and the solder pot temperature should be thermostatically maintained.

The operations are as follows:—

- Fit the assembled panel into a suitable jig.
- Apply one of the recommended fluxes by brushing or spraying. T.C.C. Flux DS.101 should be permitted partially to dry before soldering. Multicore PC.21 may be suitable for soldering immediately on being applied.
- Skim the surface of the molten solder, moving any oxides and carbonised impurities to one end.
- Apply printed circuit to surface of the solder bringing one end down first then lowering the other end and rocking slowly. Continue for five to six seconds, then remove by bringing one end out first. Do not lift panel vertically out of the solder as this can lead to the formation of tears or icicles. Do not turn soldered panel upside down, but maintain in horizontal position.
- Wipe surface of solder with a block of T.C.C. Flowing Wax Type DS.107.
- Repeat operation (d) above, but for four to five seconds only.

The panel may now be placed on one side to cool. No cleaning off of the panel is necessary, as no harmful residues remain, whilst the flowing wax leaves an even coating over the surface to prevent the adsorption of moisture and to maintain a high insulation resistance.



A four-valve battery portable dip-soldered.

PRACTICAL AMPLIFIER DESIGN.

A NEW SERIES 4.-TUNED AMPLIFIERS

By R. Hindle

Superhet Tuner

(Concluded from page 235 June issue)

It is outside the terms of reference of this series of articles to explain the theory of frequency conversion, but there is little point in leaving the reader high and dry with an I.F. amplifier and appropriate audio circuits but without the wherewithal to feed suitable signals into it. A simple tuner will be briefly described, therefore, which with the other units will complete a very powerful receiver.

The circuit is given in Fig. 17. This is quite conventional and uses another miniature valve, a Brimar 12AH8. Construction is simplified, and success assured even without a signal generator, by using an Osmor pre-aligned coilpack and another Osmor pre-aligned I.F. transformer; a midget two-gang capacitor with cord drive provides the means for tuning, and a metal dial provided to suit the Osmor coilpack is fitted.

It will be seen that no A.V.C. is fed to the frequency changer. This is to avoid the complication of an additional lead from the I.F. amplifier chassis to the tuning chassis. Control of the two I.F. stages is

Complete constructional details for various types of tuned amplifier. The concluding article of a series forming a sequel to the theoretical series published some time ago.

found to be quite adequate and, in fact, there is an advantage to be derived from running the frequency changer at full gain so long as the input signal does not overload the valve. To guard against this, and to increase the flexibility of the whole receiver, a manual R.F. gain control is fitted, provided by VR., R4 providing the limiting minimum bias. It is customary also to feed A.V.C. to the first I.F. valve via the secondary of the I.F. transformer, but as in this case the valve and the transformer are on different chassis and as there is no A.V.C. voltage available on the tuner chassis the A.V.C. has been fed to the first I.F. valve by parallel coupling as shown in Fig. 14, and the usual A.V.C. pin of the I.F. transformer on the tuner chassis is earthed. A standard pack providing long, medium and short waves was used in the prototype, but the constructor could use one of the alternative models offered by the Osmor company if he preferred.

For the sake of convenience the manual volume control has incorporated with it a mains switch which is intended to be used to switch on and off the whole equipment; how this is done by interconnecting the chassis will be explained later.

Construction

The chassis used for this unit is necessarily deeper than those used for the previous chassis as it has to accommodate the coilpack, but otherwise it is uniform. Fig. 18 gives the drilling diagram showing the chassis without folds; the layout given is outside the chassis when folded. Again, the centre positions of the major components are given and the remarks given previously regarding the fitting of these again apply. Fig. 19 gives the profile of the assembled chassis and shows the method of mounting the tuning capacitor. This has to be raised until the spindle coincides with the hole in the dial—6BA brass rod is used to provide earth connections to the chassis. Before mounting this component it is advisable to solder lengths of connecting wire to each of the fixed plate tags, though with the

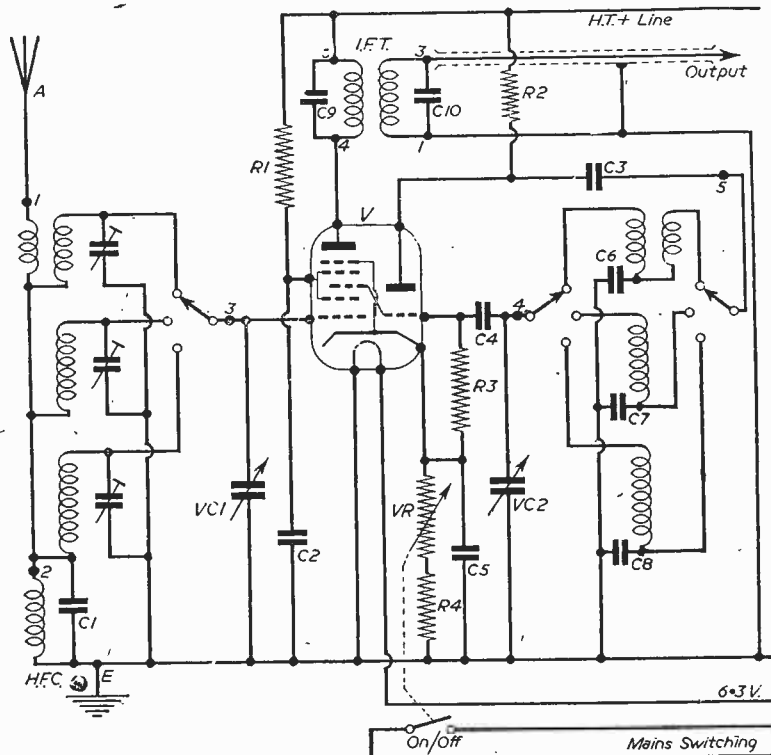

Fig. 17.—Circuit of the superhet tuner.

component specified the connecting tags are quite accessible.

• A tuning capacitor drive spindle for cord drive outside the chassis is used as this is rather simpler than the inside type, but to allow for this the dial has to be mounted forward of the chassis leaving space for the drive drum to be in alignment with the cord track on the drive spindle. Two 6BA bolts are used to fix on the dial and three full nuts between the dial and the chassis give sufficient clearance. The tuning capacitor must be mounted so that its spindle projects through the dial sufficiently to take the pointer, and the component to be used should be carefully measured before drilling the chassis in order to ensure that this is so. It helps in this connection if the three holes in the chassis for fixing the capacitor are elongated into slots so that after completion of the mechanical assembly the component can be slid backwards or forwards to get the pointer in the correct position. It is convenient to put on the drive cord before fixing on the dial.

The wiring of this unit is very simple and is given in Fig. 20. The small components are all clustered around the valveholder, which should be completely wired before connecting up the other major com-

ponents. Pin 6 of the I.F. transformer is used as the H.T. positive anchor; the other inners of the power cable are fastened to a tag strip as shown. Again, the heater wiring is first connected, running along the surface of the chassis, followed by the other wiring associated with the valve, then the coil pack; and finally the volume control and mains switch. Do not forget the connections through the chassis from the tuning capacitor.

Using the Superhet. Chassis

The superhet. tuner chassis, the two stage I.F. amplifier, the twin-triode audio amplifier (October 1954, issue) and the output stage with power pack (December, 1954, issue) together constitute a complete and powerful radio receiver, but the power pack incorporated in the output stage design will be overtaxed if asked to feed all these chassis, though it is quite adequate for the simpler tuner previously described. If the reader contemplates building the chassis to complete the superhet. version he may prefer to use for the output chassis a larger mains transformer capable of giving up to 100 mA at 250 volts with a suitable rectifier such as the Osram U709. The reader who has already assembled the output

stage will find it better to make up a separate simple power supply for the I.F. and tuner chassis, which could be similar to that in the output chassis or, alternatively, a half-wave metal rectifier such as the Brimar DRMB1B with a transformer giving 250 volts at about 60 mA. The appropriate circuit is given in Fig. 21. In addition to the power supply equipment this chassis serves as a distribution panel. The mains supply is fed into it and there are three output sockets, a two-pin socket providing the mains supply to the output valve chassis which is thus controlled by the one mains switch, a three-pin socket feeding 6.3 volts A.C. and 250 volts H.T. to the I.F. amplifier and a five-pin socket providing similar supplies for the tuner with the addition of two leads for connection to the mains switch on the tuner volume control. If the tuner course is taken of increasing the power equipment incorporated in the output valve chassis a distribution board as shown in Fig. 22 will be needed for the interconnection of the chassis power supplies. As before, a five-pin socket is provided for the tuning unit and a three-pin socket for the I.F. amplifier; an additional one is also required for the audio amplifier, which in the previous case of a separate power pack was supplied from the output valve chassis as described in the articles describing these two chassis.

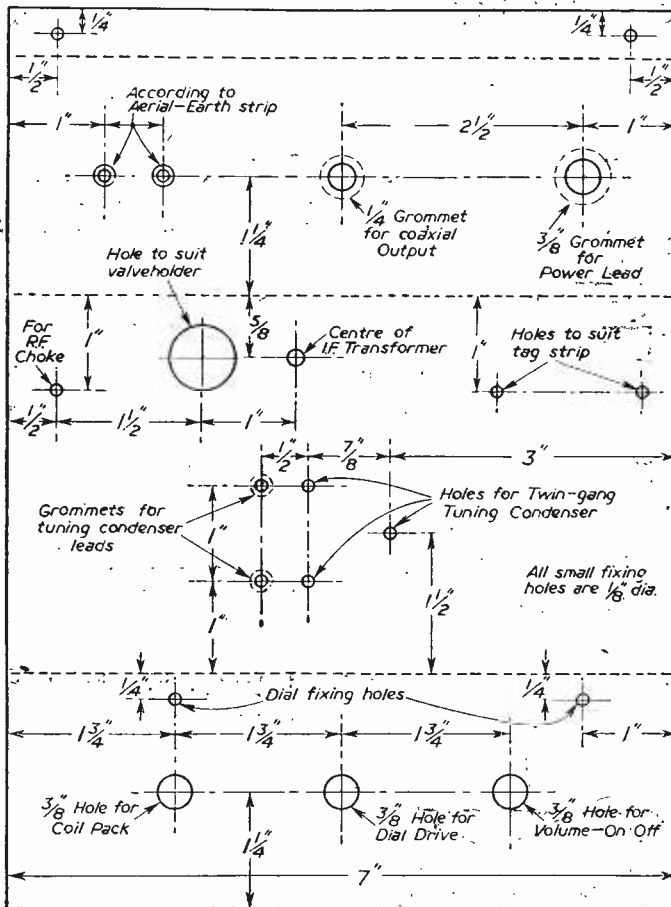

Fig. 18.—Drilling data for the chassis.

OSMOR "Q" COIL PACK ASSEMBLY

Size only 1 1/2 in. x 3 1/2 in. x 2 1/2 in.

Simply press home 4 OSMOR High "Q" coils — make only 8 easy connections and hey presto! — you have a complete OSMOR High "Q" Coilpack at a much reduced price. M. & L. wavebands, perfect for constructing new sets or conversions. Full circuit and wiring instructions included.

16/- (less coils).

Gram' position.

Price

Punched Chassis with wiring diagrams! ready for 7.5 sheet 12/6 plus 2/- p. & p.

BAND 1 FILTER

Rejects B.B.C. from I.T.A. aerial and improves picture. Suitable for all makes.

10/- inc. instructions. Fitted in 2 minutes.

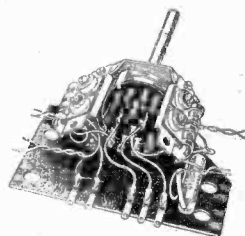

FERRITE ROD AERIALS
HIGH "Q" M.W., 8/9.
M. & L.W., 12/9.

Osmor NEW Station Separator

This improved type incorporates a special coil which has a peak performance on the station for which it is designed. As the inductance at maximum "Q" is only variable by a small degree, please state precisely the Station you wish to receive clearly. It will only operate on one Station.

10/6
Price

The Osmor NEW DIAL Assembly

This is a really attractive horizontal 3-colour slide rule, precision-built assembly. Complete with 6-Banc Perspex scale 9 in. x 4 1/2 in., for chassis-mounting L., M. and S. wavebands with Station names. The vernier drive has a ratio of 18-1 search, and 50-1 reverse. Positions for two dial bulbs. Calibrated specially for Osmor Coils and Coil-packs, Scale Length 7 in. Type S.

24/6
Price

Escutcheon for above, Bronze Finish Metal 4/-

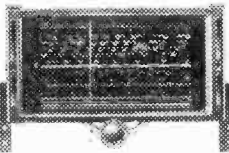

We keep right up to date in building the latest circuits, published in "Practical Wireless", "Wireless World", and "Radio Constructor," and we stock the components specified. Send 7d. in stamps for circuits, wiring diagrams, fully descriptive literature together with coil and coilpack leaflets, components lists, chassis drawings and templates.

Still only 5 connections
Smaller in size
many plus' features

The New

AMAZINGLY ROBUST

O'pack
FROM
42/-

FREE

CIRCUITS & WIRING DIAGRAMS

OSMOR RADIO PRODUCTS LTD. 418 Brighton Road, South Croydon, Surrey. Telephone Croydon 5148/9.

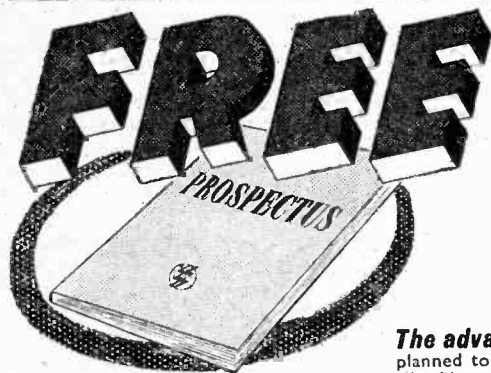

POST THE COUPON TODAY FOR OUR BROCHURE ON THE LATEST METHODS OF HOME TRAINING FOR OVER 150 CAREERS & HOBBIES

PRIVATE AND INDIVIDUAL TUITION IN YOUR OWN HOME

City and Guilds Grouped Certificates in Telecommunications: A.M. Brit. I.R.E. Examination, Radio Amateur's Licence, Radio and Television Servicing Certificates, General Radio and Television Courses, Radar, Sound Recording, etc. Also Courses in all other branches of Engineering and Commerce.

The advantages of E.M.I. training ★ The teaching methods are planned to meet modern industrial requirements. ★ We offer training in all subjects which provide lucrative jobs or interesting hobbies. ★ A tutor is personally allotted by name to ensure private and individual tuition. ★ Free advice covering all aspects of training is given to students before and after enrolling with us.

NEW LEARN THE PRACTICAL WAY

With many of our courses we supply actual equipment. Courses include: Radio, Television, Electronics, Draughtsmanship, Carpentry, Photography, and Commercial Art, etc.

Courses from 15/- per month

POST THIS COUPON TODAY

Send without obligation your FREE book. E.M.I. INSTITUTES, Dept. 32K. 43 Grove Park Road, London, W.4. Phone: Chiswick 4417/8.

NAME _____

ADDRESS _____

JULY _____

SUBJECT(S) OF INTEREST _____

EMI INSTITUTES
The only Postal College which is part of a world-wide Industrial Organisation

The universal mains version of the output stage (January, 1955, issue) used a 35W4 rectifier which is rated at 100 mA and therefore is adequate for the whole of the chassis. The interconnection unit in

then the output valve and finally at the dropper end the rectifier, as shown in Fig. 23. Similar arrangements are made to provide H.T. to the chassis via output sockets as in the A.C. case, but it is better to provide a two-pole mains switch on the manual volume control in this case and, consequently, a seven-pin socket is needed for the tuner supply. The 6BA6 valves specified for the I.F. amplifier will not be suitable for universal working and instead 12BA7 valves should be substituted. In the case of the tuner chassis the 12AH8 is correct, but the base must be wired to put the two sections of the heater in series instead of in parallel as given in the constructional description. Finally, the dropper resistors must be adjusted to give the correct .15 amp. current through the chain; both resistors will be adjusted to about half their maximum, but preferably the current should be finally adjusted using a suitable meter.

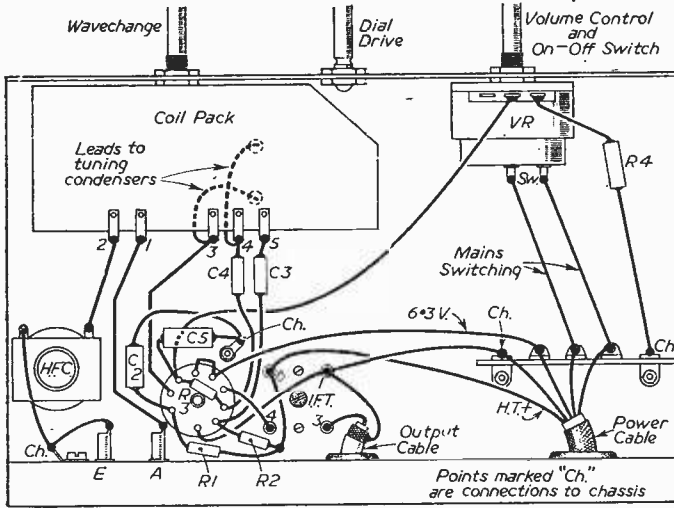

Fig. 20.—Wiring diagram of the superhet tuner.

this case has to be wired to put the valve heaters in series with the audio amplifier at the earthy end of the chain, followed by the I.F. amplifier (the two valves on this chassis having their heaters in series instead of in parallel as given in the circuit diagram),

and switch on, putting the R.F. manual gain control at maximum and advancing the audio gain control to about quarter way. Connect aerial and earth, and

Alignment

If pre-aligned components have been used this process will be very quickly carried out. Carefully complete the interconnection of the chassis

Fig. 19.—Side view of the superhet tuner.

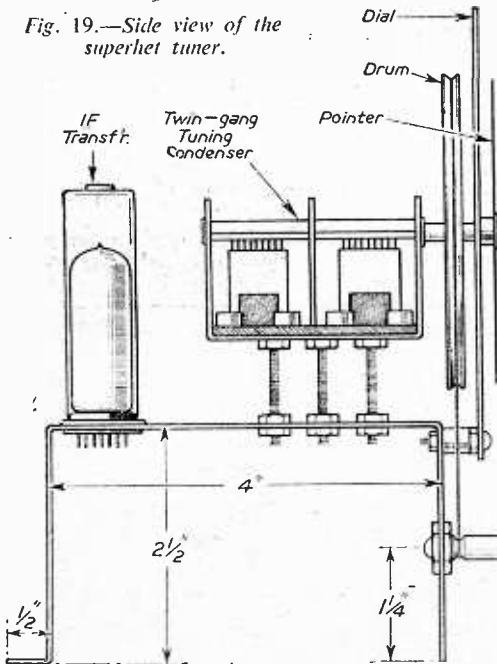

LIST OF PARTS FOR FIG. 17

- C1, 6, 7, 8 Part of coilpack.
- C9, 10 Part of I.F. transformer.
- C2, 5 .1 μ F 250 v. Dubilier type 410.
- C3, 4 100 pF. Dubilier type 400.
- R1 33 K Ω $\frac{1}{2}$ w. } Dubilier type BT.
- R2 27 K Ω $\frac{1}{2}$ w. }
- R3 .47 K Ω $\frac{1}{2}$ w. }
- R4 100 Ω $\frac{1}{2}$ w. }
- VR 25 K Volume control with single pole switch Dubilier Type C
- VCI, 2 500 pF two gang Osmor Miniature.
- V 12AH8 Brimar.
- HFC Osmor type QC1.
- Coilpack Osmor type HO.
- I.F.T. Osmor miniature.
- I Valveholder B9A.
- I Aerial-earth socket strip.
- I Tag strip 3-way and earth.
- I Dial Osmor metal.
- I Drive spindle (cord outside chassis), cord, spring, pointer, coaxial cable, wire, sleeving.

it should be quite possible to tune in a signal. Using one that is only weak (indicated by the background noise which shows that the A.V.C. is not taking Control) adjust all three I.F. transformers to give maximum signal strength—very little adjustment should actually be needed. If the signal available is strong it can be reduced by using a short piece of wire as an aerial and it will be advisable to short circuit the A.V.C. capacitor for final adjustments, leaving it short-

circuited for the rest of the adjustments, but not forgetting to remove the short before putting the receiver into service. The capacitor in question is C14 of Fig. 14. Now, on medium waves with the waverange switch in the middle position (probably

correctly over the calibrations. If it is slightly out, bring the signal to the correct point on the dial by adjustment of the medium wave oscillator coil core. Now tune to maximum, using the core of the medium wave aerial coil. A station at the lower end of the

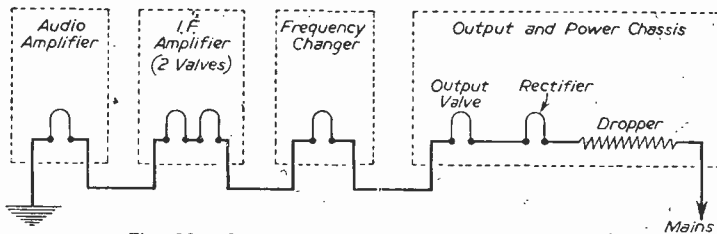

Fig. 23.—Heater chain—Universal mains version.

the signal used for the above adjustment will have been found on this range) find a signal towards the upper end of the waverange and identify it to see if it coincides with the calibration of the dial, the pointer having been fixed previously so that it sweeps

range is then identified and brought on to the correct tuning position by means of the medium wave trimmer (leaving the core alone) and the aerial trimmer for this range adjusted for maximum signal strength. Alternate between upper and lower ends of the range, adjusting in this manner and with patience an accurate adjustment will be obtained. Do not attempt to adjust in the absence of a signal, however, as it is unlikely that the components are so far out of adjustment as not to provide a station, and trouble must be looked for elsewhere.

The long waverange is similarly adjusted, but on the short waverange it is better not to adjust the oscillator circuit at all without a signal generator and the constructor should be content with the adjustment of the aerial core and trimmer as above for maximum signal.

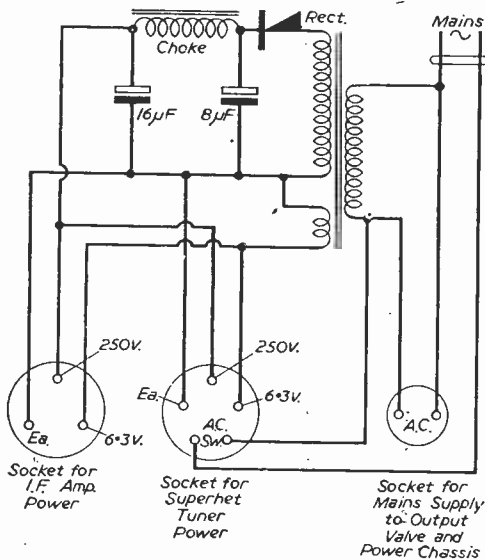

Fig. 21.—Power supply and distribution chassis.

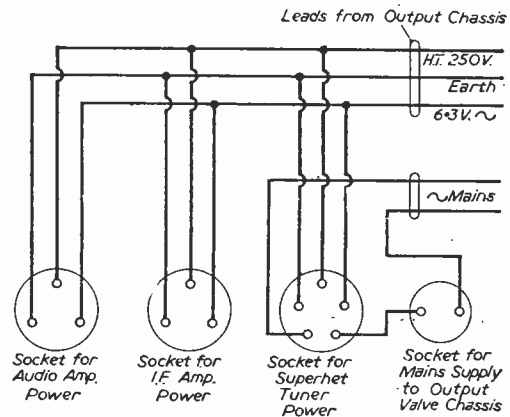

Fig. 22.—Distribution board where larger power equipment is incorporated in output valve chassis.

New Ceramic Pick-up

A NEW ceramic pick-up cartridge for high-fidelity reproduction of standard and long-playing gramophone records is being manufactured by Technical Ceramics, Ltd., of Towcester, Northants.

Known as "Sonotone," the cartridge differs from conventional pick-up cartridges in that it is constructed from a high-grade ceramic material which gives vivid sound reproduction over a very wide frequency range. The response curve has been plotted and follows almost exactly the curve specified by leading record manufacturers as ideal for the optimum reproduction of high-fidelity long-playing records.

Sonotone pick-up cartridges are made in Great Britain by Technical Ceramics, Ltd., under an agreement with the Sonotone Corporation of New York, U.S.A.

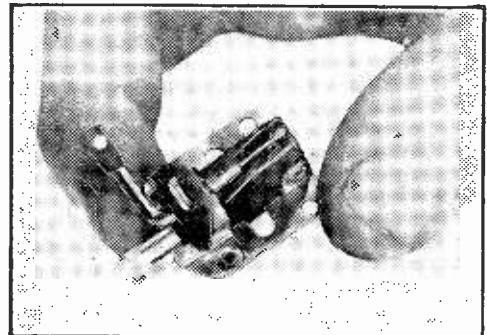

A Novel Test Set Built up From Three Units and Utilising a 3½ in. Tube

By R. Couvela

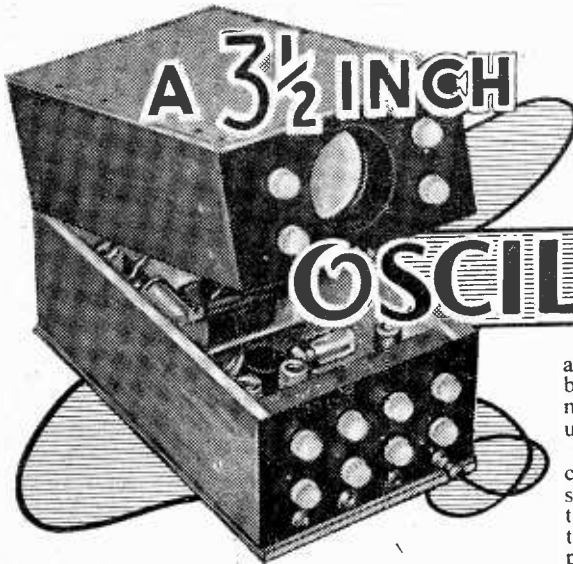

OSCILLOSCOPE

THIS oscilloscope has been designed primarily to meet the needs of the amateur and as a handy instrument for the Serviceman.

The main points that were borne in mind during the design were, first, that it should be reasonably cheap to build, but this was not allowed to interfere too much with the performance. Secondly, that it should be versatile. Without changing any plugs round, the plates can receive either a linear timebase, a sinusoidal timebase or an external signal. Similarly, the sync can be obtained from 50 c/s (for frequency checking), internally from the Y amplifier or externally.

The third point was that it should be easily serviced. For this reason it is built in three sections, each of which can be serviced independently without interfering with the others.

Fourthly, its sensitivity should be ample for the amateur, and the value obtained is, in fact, about 5 cm/volt R.M.S. at 50 c/s.

The final point was that it should be simple and easy to operate. For this reason all the controls are mounted on the front, the tube is provided with a light shield to protect it from glare, and the body is hinged, as shown in the photographs, for easier inspection of the picture, as it can be tilted to any angle.

The Cabinet

The size of the unit was limited by two factors: first, the front panel must be large enough to carry 12 knobs, the C.R.T. face and four coaxial sockets. The panel was made as small as practicable with these considerations in mind. Secondly, the length must obviously be sufficient to hold the C.R.T.

With these limitations the smallest overall dimensions obtainable are 16in. x 9½in. x 12in. high approximately. These dimensions could be reduced slightly, but it was considered of no practical advantage.

The cabinet is built in two parts. The base, whose internal dimensions are 15in. x 5½in. x 8¼in. approximately to house the power pack, the timebase

and amplifier units. This is made of ½in. sides, ¾in. back, and ¾in. plywood bottom. The front panel may be of any material about ¼in. thick, its principal use being decorative.

The lid contains the cathode-ray tube and the controls immediately associated with it. This has the same dimensions, but is only 5in. deep. On the prototype the sides, however, were made from ¾in. wood to give additional strength. The tube face is supported by a piece of ¾in. wood with a hole cut to fit the tube. The front panel has a hole cut the same size, and the cavity is painted black to avoid stray reflections.

The two sections are hinged together with a 9in. length of piano hinge, which may be bought at a good ironmonger's. If this length is not available, these hinges may easily be cut down. Additional fixing holes may be drilled if desired to give extra strength.

The construction should offer no difficulties, but it may be found an advantage to leave the front panel off during initial stages.

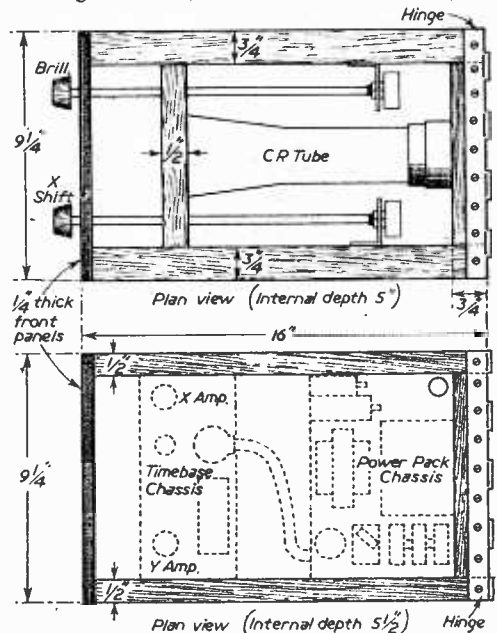

Figs. 1 and 2.—General layout and dimensions.

Timebase and Amplifier Unit

The construction of this will offer few difficulties if taken systematically, although it looks rather complicated. The basis is that the valves are mounted on a chassis 8 in. \times 4 in. \times 2 in. deep, while the panel for the controls must be 8 in. \times 5 in. to accommodate eight controls and four coaxial sockets.

This is done by bolting these two sections together, but it will be seen from the photographs that the

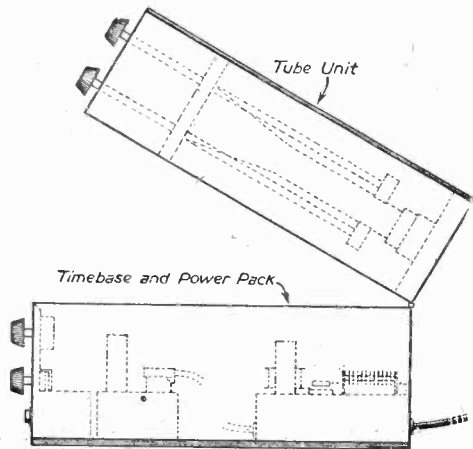
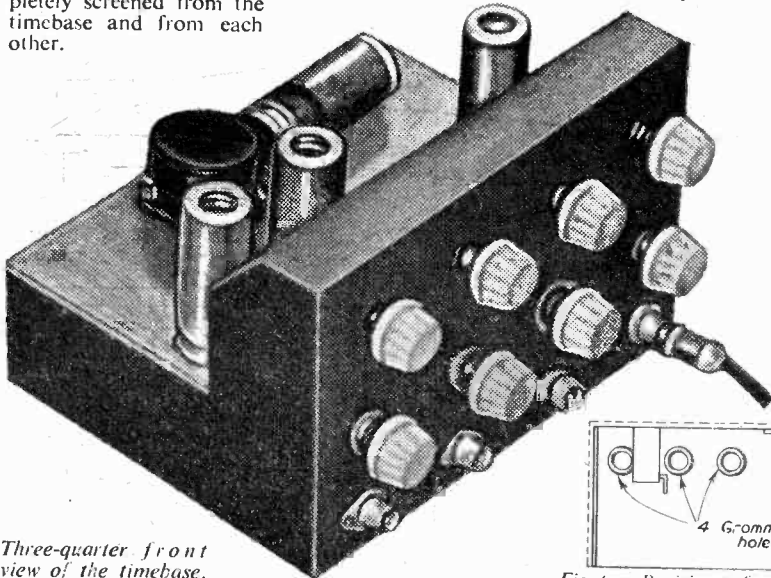

Fig. 4.—Side view of the completed instrument showing internal parts.

prototype was built from one sheet of metal welded at the edges. This could be copied by anyone with sufficient facilities, but is not recommended unless the correct tools are available.

It will also be noticed that the amplifiers are completely screened from the timebase and from each other.



Three-quarter front view of the timebase.

Amplifiers

The X and Y amplifiers are identical, using a 12AT7 valve on a B9A base. This is a double triode, and the circuit enables it to give a push-pull output to the plates, which are directly connected.

The valve has a 6.3/12.6 volt heater arrangement, and in this case it is wired for 6.3 volts, i.e., the two sections of the heater are wired in parallel.

The valve is supplied with a screen because, as will be seen later, the scope can work at fairly high frequencies, and also as there is no internal screening to the valve interference can be picked up quite easily even at fairly low frequencies.

Components required for each amplifier are as shown on page 326.

It will be noticed that when the scope probe is placed in a circuit under test 1 M Ω is placed between that point and earth. If this should interfere with the circuit under test, which is unlikely, a probe could be constructed with a capacitor built in.

Sync is obtained direct from the Y plates. This

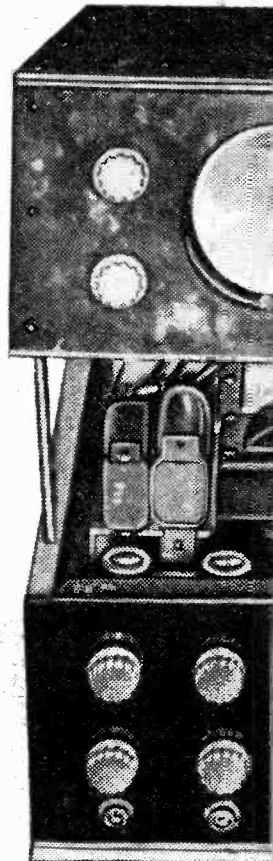

The finish

connection is, of course, omitted from the X amplifier.

Timebase

The timebase is similar to that described in these pages recently.

The valve used is again a 12AT7 on a B9A base, the essential features of the

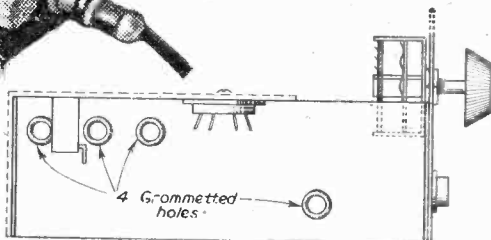
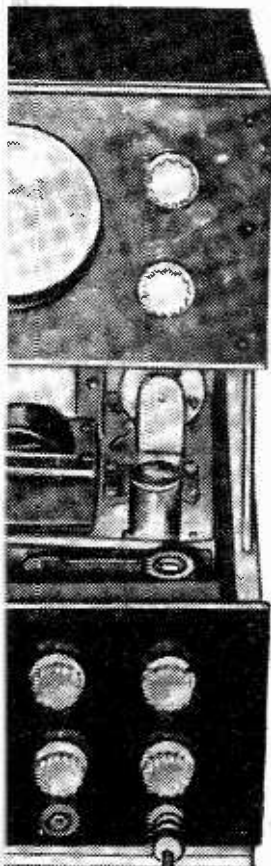

Fig. 6.—Positions of grommet, in timebase unit screens.



circuit being that a capacitor charges through a resistor and is discharged through the valve.

C6-11 are the charging capacitors, the switch providing coarse frequency adjustment.

VR9 is the variable resistor through which the capacitors are charged. R10 is placed in series with it to limit the minimum value. If R10 is omitted and VR9 turned down the voltage on the grid of the valve will rise, causing damage to the electrodes of the valve due to diode action between grid and cathode.

Some constructors may prefer to use values of C6-11 to suit their particular requirements, but a value above 0.25 μ F causes non linearity.

The indicated values gave a frequency range on the prototype of approximately 120 c/s to 200 kc/s.

If adjustment is to be made it should be borne in mind that, as explained in the above-mentioned article, frequency is inversely proportional to capacity and resistance.

Sync is applied to cathode of the timebase valve. It comes from a four-way switch, giving internal, 50 c/s, external, or none. It is applied

ed Scope.

to the slider of VR14, which will cause it to have greater or less effect as this potentiometer is altered. In the arrangement shown it cannot be

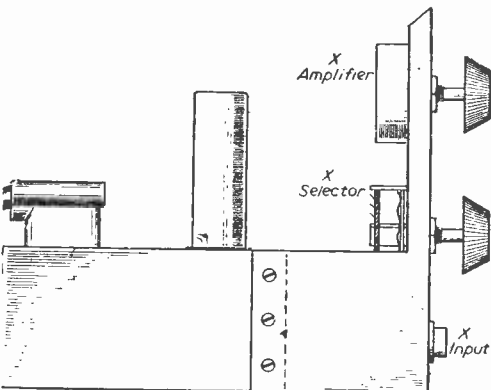

Fig. 7.—Side view of the timebase unit.

completely removed by the pot., but if desired a 1,000 Ω control may be substituted for R14-15.

R8 is required to limit the voltage on the anode to the maximum permissible for that valve type. H.T. is decoupled by C5, which need not necessarily be mounted horizontally as in the photographs.

Components required will also be found on page 326.

Power Pack

This is a very straightforward piece of apparatus,

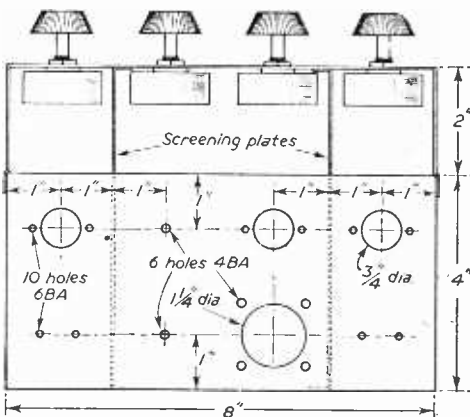
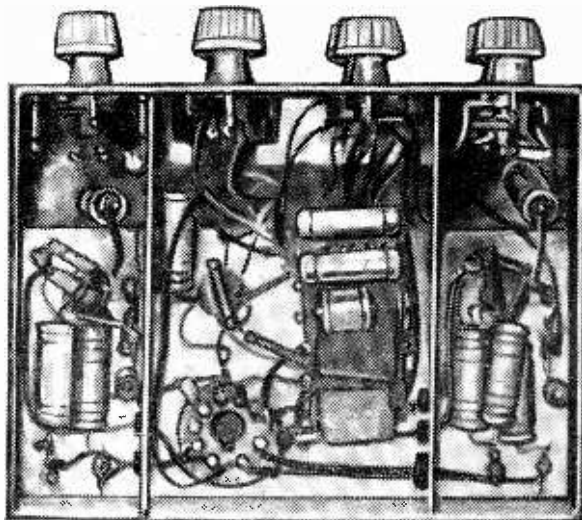

Fig. 5.—Chassis details of the timebase unit.

employing a 350-0-350 volts transformer as 0-350-700 volts. With 0 terminal taken to earth, a half-wave rectifier at the 350-volt terminal, with the smoothing provided, gives about 510 volts o/c H.T. to the timebase and amplifiers.

A further half-wave rectifier at the 700 volt terminal gives about -900 volts o/c EHT to the tube.



Underside view of the timebase unit.

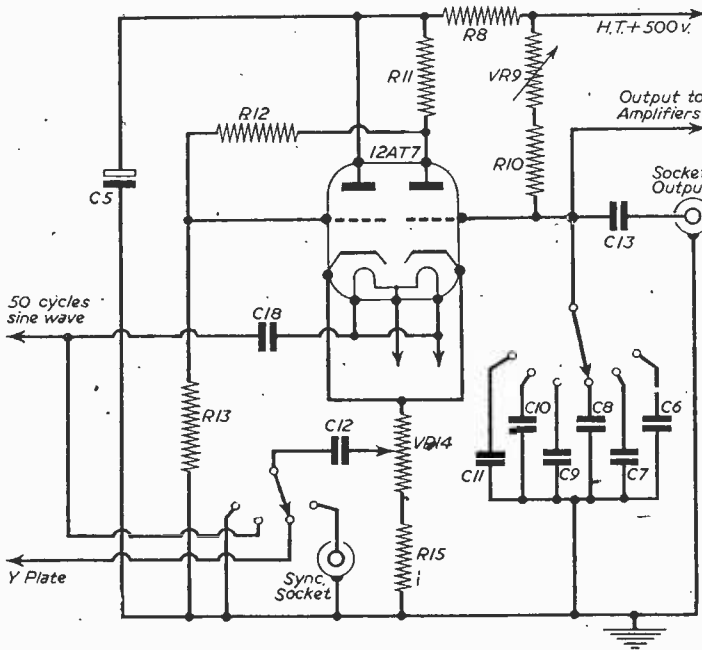

Fig. 10.—Circuit of the timebase unit.

PARTS FOR EACH AMPLIFIER (Fig. 9)		PARTS FOR THE MAINS UNIT	
V—12AT7		Mains Transformer—350-0-350 v. 80 mA, 6.3 v., 1 A, C.T., 4 v., 1 A	
VR1—1 M Ω potentiometer		MR1—3 x sentercell RM1	
R2—1 M Ω		MR2—K350 (1,000 v. 1 mA)	
R3—220 Ω		L—60 mA choke 10.H.	
R4—5 k Ω 3 w.		C14-15—16-16 μ F 500 v.w	
R5—1 M Ω		C17—0.5 μ F 1,000 v.w	
R6—22 k Ω		C16—0.25 μ F 1,000 v.w	
R7—22 k Ω		R16—1 M Ω	
C1-4—0.02 μ F 500 v.w.		R17—2 M Ω	
SW1—1-pole 3-way Yaxley Coax. socket		R18—47 k Ω	
Valveholder—B9A—with screening can		Mains adjust panel	
Two knobs			
PARTS FOR THE TIME-BASE (Fig. 10)		PARTS FOR THE TUBE UNIT	
Valve—12AT7		Tube—VCR138	
Holder—B9A with screen		Holder	
R8—10 k Ω 3 w.		R19—1 M Ω	
VR9—2 M potentiometer		R20—1 M Ω	
R10—690 k Ω		VR21—25 k Ω	
R11-12—100 k Ω		R22—68 k Ω	
R13—22 k Ω		VR23—100 k Ω	
VR14—500 Ω potentiometer		R24—330 k Ω	
R15—500 Ω		R25—150 k Ω	
C5—30 μ F 350 v.w. electrolytic		VR26—1 M Ω	
C6—0.1 μ F		VR27—1 M Ω	
C7—0.03 μ F		C19—1 μ F	
C8—0.01 μ F		4 knobs	
C9—0.003 μ F		4 extension spindles (insulating)	
C10—0.001 μ F			
C11—300 pF			
C12, 13, 18—0.02 μ F 500 v.w.			
Sw 1—1-pole 6-way			
Sw 2—1-pole 4-way			
2 coax. sockets			
6-way tagboard			
	4 knobs		

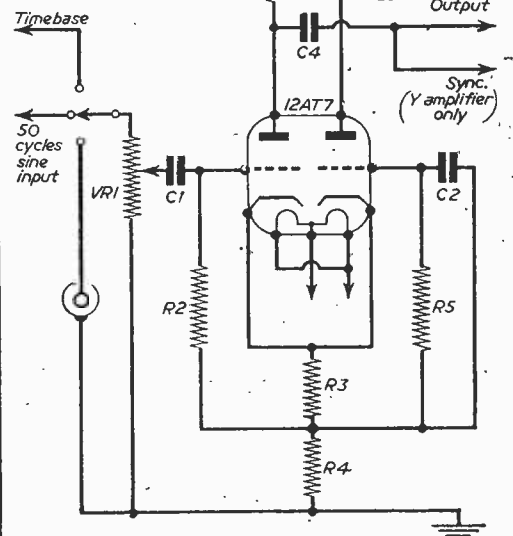

Fig. 9.—Circuit of the amplifiers.

type, VCR138, which has a 3½ in. screen, a green glow and negligible persistence.

The circuit used is perfectly straightforward. The cathode is on EHT negative, EHT positive being earth.

Shift voltages are obtained by connecting two 1 M Ω potentiometers from +150 volt (lead "sh" on power pack) to -150 volts (obtained from tube bleeder).

(To be continued)

The transformer is required to give both 6.3 volt and 4 volt heaters and, as few transformers are available with three heater windings, it was considered best to use metal rectifiers.

No switch is provided in the mains lead, as it would become a nuisance if brought to the front panel.

The output marked "sh" in the diagram is taken to the tube circuit and is used for supplying shift, and will be explained later.

The choke in the prototype was unnecessarily bulky and a standard model will do.

Components are shown below.

The valves may be operated, if desired, from a 12.6 volts supply, centre tapped, rated at ½ amp., but the 6.3 volt arrangement is preferable.

Tube Circuit

The tube used is an ex-Service

MAKE THE MOST OF YOUR TAPE-RECORDER

with a LUSTRETTE Dynamic Microphone



ACCLAIMED EVERYWHERE FOR ITS WONDERFUL REPRODUCTION

Plugs straight into any tape-recorder to provide brilliant new high-fidelity recordings for amazingly modest cost. The "Lustrette" is omnidirectional, completely faithful to the original sound and unaffected by temperature and weather variations. It is also of robust construction and can be used as both hand and stand instrument. This is the ideal replacement microphone for all types including crystal and condenser.

67'6

The "Lustrette" is made by Lustraphone, whose reputation for making quality microphones for every purpose is world-wide. Carries the full Lustraphone Guarantee.

In Ivory Plastic housing, 2 1/2 in. wide, with 9 ft. cable.

Literature on request from: **ST. GEORGE'S WORKS, LUSTRAPHONE LTD., REGENTS PARK ROAD, LONDON, N.W.1.**

Phone: PRImrose 8844.

HANNEY of BATH offers:—

VIEWMASTER 3-STATION TV TUNER (P. Television).—Denco coilset with screens, can and screws, 30 -; Denco switch, Fine Tuner, Coil mounting plates and tax panel, 27 -; Kit of resistors, 7 6; TCC condensers with and tax panel, 27 -; Kit of resistors, etc., 43 -; Gain controls, 33 each; Co-ax P.Skit, 2 6; Valve cans, 13 each. Complete kit of parts for the TUNER, with the 2 Genuine MULLARD Valves, nuts, bolts, wire co-ax., etc., £8 19 6. Denco Coilset for conversion of the V-Master S V chassis to the I.F. amplifier, 20 -. OR Complete kit of S V conversion components, 39 6. All Standard V-Master items in stock. Full list available.

MULLARD 3-VALVES 3-WATT AMPLIFIER.—Punched chassis, 10 8; Gilson Trans., Mains, 35 -; Output, 25 6; Elstone Trans., Mains, 35 -; Output, 21 -; Condenser kit, 20 -; Resistor kit with 3 pots, 22 6. Complete kit with Genuine Mullard VALVES, £8 19 6. Full list available.

MULLARD 510 AMPLIFIER.—Erie Resistors, 27 -; TCC Condensers, 45 -; Elstone Mains Trans., 36 -; 100 m.a.); 42 6 (120 m.a.); Output Trans., 45 - (6K, or 8K); Gilson mains trans., 60 - (140 m.a.); Output trans., 47 6 (6K, or 8K); Ultra Linear type, 52 6; Partridge Mains trans., 65 6; Output trans., P.3667, 55 6; Partridge Ultra Linear type P.4014, 98 6. Denco punched chassis, 19 6, with base plate; Printed front panel, 6 6; Type "A" and "B" Chassis (panel not printed), 8 6 and 12 6 respectively; condensers, "A", 15 6; "B", 2 6; Resistors, "A", 17 6; "B", 35 6 (with pots.). Full list available, giving details of complete kits.

OSRAM 912 PLUS AMPLIFIER.—Erie resistor kit, 17 4; Erie 1 meg. pots, 4 6 each; TCC condenser kit, 55 -; PART-RIDGE components with loose lead terminations, includes packing charge), Mains trans., 65 6; choke, 34 6; output trans., 45 6; W.B. components, Choke, 18 9; output trans., 32 -; Denco drilled chassis, 14 6; Denco 912 Plus printed panel, 7 6; Pre-amp or passive chassis, 6 -. Full list available.

COMPONENTS are still available for the following **F.M. TUNERS**: Wireless World, Mullard, Osram 912, Denco Max-0. List available. **WIDE ANGLE COMPONENTS**. ALLEN. Treking Chassis, 50 -; Coilsets (TK and Super-Visor), 44 6; L.O.308, 40 -; FO.305, 21 -; DC.300c, 39 6; FC302, 31 -; GL.16 and 18, 7 6 each; SC.312, 21 -; AT.310, 30 -; OP.117, 9 -; BT.314, 15 -; DENCO Chassis Magnaview, 37 6; Chassis Super-Visor, 51 6; WA LCI and Magnaview, 41 2; WA DCAI, 43 -; WA FCAL, 31 -; Coilsets WA LCI and WCI, 7 6 each; WA FMAI, 21 -; WA LOTI, 42 -; WA FBTI, 16 -.

Send stamp for lists. Please add 2/- postage to all orders under £3 (excess refunded).

L. F. HANNEY

77, LOWER BRISTOL ROAD, BATH

Tel.: 3811

HERE IT IS!

YOUR LAST CHANCE!

THE **NEW** 1956 EDITION

NEWNES

Radio and Television Servicing

FREE for 7 DAYS

THIS is the most complete collection of models ever assembled—it provides all the data, circuit diagrams and component layouts you need to service over 1,550 different models. The work covers Multi-channel T.V. receivers, Band III converters, Radios, Radiograms, VHF/FM receivers and adaptors, Portables, Car radios—and can pay for itself within a week of receiving it. Prove this by claiming Free Examination NOW!

1,550 POPULAR MODELS including LATEST RADIO SHOW MODELS

TELEVISION

RADIO

SERVICING DATA for—
Ace, Alba, Ambassador, Argosy, Baird, Banner, Beethoven, Bush, Champion, Corsor, Decca, Defiant, Ekcovision, E.M.I., English Electric, Ferguson, Ferranti, G.E.C., H.M.V., Invicta, K-B., McCarthy, McMichael, Marconiphone, Masteradio, Mullard, Murphy, Pam, Peto Scott, Philco, Philips, Pilot, Portadyne, Pye, Rainbow, Raymond, Regentone, R.G.D., Sobell, Stella, Ultra, Valradio, Vidor.

SERVICING DATA for—
Ace, Ambassador, Banner, Beethoven, Bush, Champion, Corsor, Decca, Denico, Defiant, Eddystone, Ekco, Etronic, Ever Ready, Ferguson, Ferranti, G.E.C., Grundig, Invicta, K-B., McCarthy, McMichael, Marconiphone, Masteradio, Mullard, Murphy, Pam, Peto Scott, Philco, Philips, Pilot, Pye, Rainbow, Raymond, Regentone, R.G.D., Roberts Radio, Sobell, Strad, Ultra, Vidor.

Owners said the last edition was worth a fortune! This New Edition is even more valuable. Prove it yourself by sending for Free Examination—no cost or obligation.

6 VOLUMES, 3,153 PAGES, 3,000 CIRCUIT, COMPONENT AND CHASSIS LAYOUT DIAGRAMS. FREE 2 YEARS' ADVISORY SERVICE.

DON'T MISS THIS GREAT OPPORTUNITY

To: George Newnes, Ltd., 66-69 Great Queen St., London, W.C.2.

Send me Newnes RADIO AND TELEVISION SERVICING. I will either return it in 8 days or send 9s. deposit 8 days after delivery, then 10s. monthly, paying £9 9s. in all. Cash price in eight days £9.

Name.....

Address.....

Place X where it applies

Occupation.....

HouseOWNER

Householder

Signature.....

Living with Parents

Lodging Address

RTV 3F

FULLY GUARANTEED

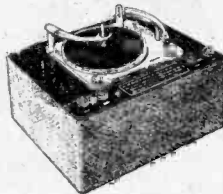

CAT. NO. UNIT A/35
Chassis as type CR/A described elsewhere. 3 valve Superhet, 3 wavebands.
29½ Gns.

★ RADIOGRAM "DROP-IN" UNITS

These are fully guaranteed Radiograms consisting of Receiver Chassis, Auto Record Changer and matching Loudspeaker mounted on a lightweight frame with polished top panel. Needs only fixing inside suitable cabinet to become high quality Radiogram. Offered in two different models.

CAT. NO. UNIT/AFM47
Chassis as type CR/AFM47 described elsewhere. 7 valve Superhet with F.M. 37½ Gns. V.H.F. Band.

Both units are fitted with latest BMR FOUR-Speed Auto Changer. Packing and Carriage, 20/-.
HIGH QUALITY BUREAU TYPE CABINET TO SUIT EITHER UNIT. 15 Gns.

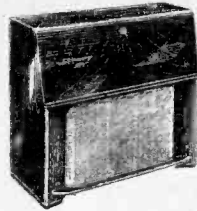

★ CABINET

CAT. NO. CAB/02
A well-designed Bureau type cabinet in a medium size. Veneered in a highly figured Walnut. Outside dimensions: length 29½ in., depth 16 in., height 32 in. Sloping control panel on right hand side approx. 13 in. x 10½ in. Removable baseboard on right hand side approx. 18 in. x 13 in. Large record compartment located inside the cabinet above gram motor.

CASH 12 Gns. ONLY

Packing and Carriage, 20/-.



built to the highest standard!

ALL FULLY GUARANTEED. GENEROUS EXTENDED CREDIT TERMS ON ORDERS EXCEEDING £15.

★ RADIO & RADIOGRAM CHASSIS

Superhet. Chassis of Latest Design. General Specifications applicable to all models. Mains : A.C. 200/250 volts 50 cycles only. Dial : Suitably lit multi-coloured glass dial of the horizontal type. Tuning Drive : Slow motion by means of glass-cored Nylon cord. A.V.C. : Full provision of Automatic Volume Control Negative feed-back from output transformer secondary.

Sockets : Sockets provided for Aerial, Earth, Gram, Pick-up and Extension Speaker. Connections provided to Gram. Motor controlled by Chassis On/Off switch.

Inductances : All inductances have an exceptionally high Q value.

Audio Section : The Audio Section is designed for first rate reproduction on Radio and Gramophone. The tone controls have been given an extra wide range to embrace all types of recordings.

CAT. NO. CR/A : 3-valve Superhet 3 Wavebands..... 12 Gns.

CAT. NO. CR/B : 7-valve Superhet with push-pull output, 3 Wavebands..... 16 Gns.

CAT. NO. CR/AFM47 : 7-valve Superhet with FM/VHF Band (4 Wavebands)..... 23½ Gns.

CAT. NO. CR/AFM49/PP : 9-valve Superhet with FM/VHF Band (4 Wavebands), Push-pull output including 2 loudspeakers..... 26 Gns.

Packing and Carriage on Models CR/A and CR/B, 15/6.

Packing and Carriage on Models CR/AFM47 and CR/AFM49/PP, 15/-.

★ MULTI-SPEED AUTOMATIC RECORD CHANGERS

All automatic Record Changers are of the latest type and unused.

CAT. NO. RC/A : This is the latest multi-speed auto changer incorporating 16 r.p.m. for "talk

ing-looks", and arrangement for manual control. Fitted with high fidelity H.G.P. 37 Crystal Turnover Pick-up Head. A.C. mains 200/250 volts. 50 cycles only.
PRICE : CASH ONLY £7-19-6

PACKING AND CARR. : 12/6.

CAT. NO. RC/B : Latest GARARD RC88 model, fitted with G2 Crystal Turn-over Pick-up Head. A.C. 200/250 volts 50 cycles.

PRICE : CASH ONLY £13-0-0

PACKING AND CARR. : 12/6

★ PORTABLE TAPE RECORDER

Cat. No. TR/A
A superb High-Fidelity instrument incorporating the latest TRUVOX Tape Deck. In a beautifully fitted moroccan grained carrying case, this Tape Recorder is the very finest of its class, regardless of price.

TAPE DECK : TRUVOX model TRU. Twin track with B.B.B. sense of recording. Two speeds, 7½ in. (one hour for 1,200ft. reel), and 3 in. (2 hours for 1,200ft. reel). Full press-button control. Fast forward and rewind. Electro-magnetic braking.

PRICE : CASH ONLY 44 Gns.

PACKING AND CARR. : Payable in advance with order, 25/-.

★ PORTABLE TAPE RECORDER (KIT FORM)

Cat. No. TR/A/KIT.
A complete kit consisting of:—
FULLY FITTED CARRYING CASE
TAPE DECK—TRUVOX TRU
TAPE RECORDER AMPLIFIER
MICROPHONE—ACOS 33-1
SPEAKER—7 in. x 4 in. Elliptical
MAGNETIC TAPE REEL

To the same specifications and similar to those used in the Portable Tape Recorder (Cat. No. TR/A), this complete kit offers the home-builder all that is required to construct a portable Tape Recorder of the finest quality.
42 Gns.

PACKING AND CARRIAGE : Payable in advance with order, 25/-.

★ F.M./V.H.F. TUNERS

CAT. NO. FMT A
An F.M./V.H.F. Tuner Unit with automatic Magic Eye Tuning, fitted in a high grade dark Walnut cabinet. Adaptor is self-powered and completely self contained.

CIRCUIT DETAILS : SIX Valves and 10 Tuned Circuits for maximum sensitivity and best signal to noise ratio.
PACKING AND CARRIAGE, 12/6. 16½ Gns.

CAT. NO. FMT B
An F.M./V.H.F. Tuner Unit in chassis form, suitable for building into existing Radiograms or Radio Receivers. Adaptor is self-powered. Socket for additional Magic Eye filament is provided in the chassis.
PACKING AND CARRIAGE, 12/6. £13-15-0

★ BUREAU CABINET

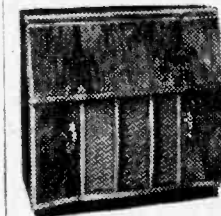

CAT. NO. CAB 03

A magnificent Bureau type Cabinet of the very highest quality in specially selected Walnut veneered exterior.

Light Sycamore interior with BeXine lining to match. Outside dimensions : length 34 in., depth 17½ in., height 33 in. Sloping control panel on right-hand side approx. 16 in. x 10½ in. Removable baseboard on right side approx. 18 in. x 13 in. Two full-sized felt lined compartments 18 in. x 13 in. in the lower half.
16½ Gns.

PACKING AND CARRIAGE : Payable in advance with order, 25/-.

DEALERS SUPPLIED AT FULL DISCOUNTS

All enquiries (excluding Northern Area) to :

DOMESTIC

DIRECT SALES LTD.

90 JUDD ST., LONDON, W.C.1. TER. 9876

Northern enquiries only (not Scotland & N. Ireland) to :

MAYLIT LTD.

3 MARLBOROUGH RD., ALTRINCHAM, CHESHIRE
Telephone enquiries: ALTRINCHAM 4045

A High-Power TAPE AMPLIFIER

By B. L. Phillips

SOME DETAILS OF IMPROVEMENTS TO THE BASIC CIRCUIT PUBLISHED IN THE MARCH ISSUE

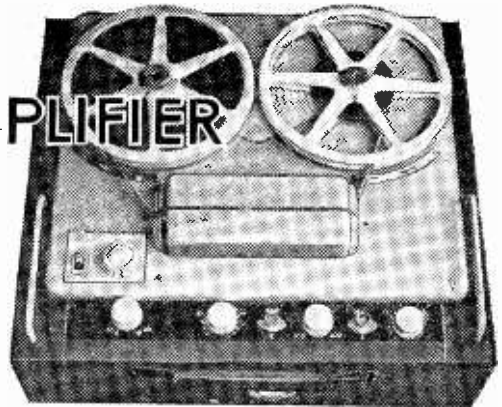

ONE improvement which can be made without any drastic amplifier alterations is that concerning the magic-eye level indicator. In the original circuit this was fed via V2 anode, and it will be appreciated that only a fairly small signal was available to operate the indicator. To increase the signal on the 6U5 control grid the modification shown in Fig. 1 was evolved. It consists of including the magic-eye in the recording head circuit. The audio supply to the record head is "split" by placing a 100K Ω resistor between switch wafers S1.B and S1.C. The signal for the 6U5 is taken off at S1.B contact via a 470K Ω resistor. This resistor is to prevent placing a heavy load on the record head. It also supplies a high impedance to the bias supply which would otherwise prevent the indicator operating correctly. A 0.002 μ F capacitor is placed across the 6U5 grid to chassis to return any bias frequency to the earth line (chassis).

Bias Supply

The 45 kc/s bias supply to the recording head is still fed via VR3 (150K Ω wirewound), but now it has a 100K Ω fixed resistor in series with it. The bias is fed to the recording head via switch wafer S1.C. Incidentally, the oscillator circuit is not now so loaded as in the original circuit and the waveform on an oscilloscope is very nearly a pure sine-wave. To any constructors who may experience trouble in poor erasing and/or intermodulation distortion on

recording due to a bad oscillator waveform, this circuit in Fig. 1 should cure these troubles. The correct modulation level with this circuit will be when the segments on the magic-eye just meet on loud passages, and it was found that the level could be seen quite a way from the recorder.

One other notable feature of this modification that was found very noticeable was the fact that no recordings since have been spoilt by either over or under modulating.

An Extra Stage of Amplification

In the original circuit the maximum power output on playback from tape is 8 watts with a correctly modulated tape. Some constructors may require the full 12 watts output for some purposes, so the following extra stage of amplification can be added if so desired.

The new stage consists of a triode, an L63, which is mounted on the side of the chassis containing the output and oscillator circuits. Fig. 2 shows details of the mounting, but this will be described in detail later on in this article. The extra valve is inserted in the circuit as follows.

V3 is no longer the phase-splitter on playback; the L63 now performs this task. The alterations to the recording output valve (V3, 6SN7) consists of an anode load of 33K Ω , decoupled by a 47K Ω resistor and an 8 μ F capacitor. The cathode is permanently

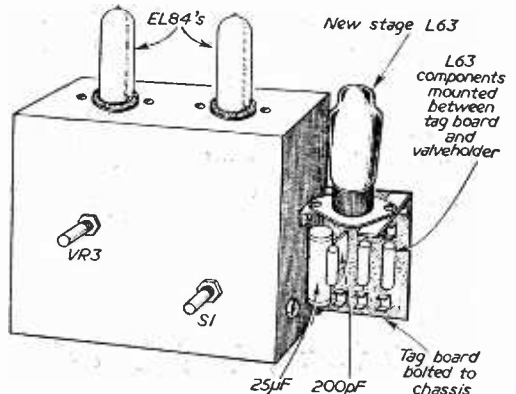
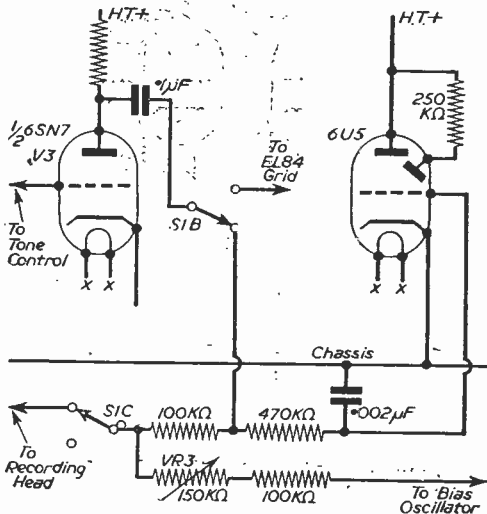
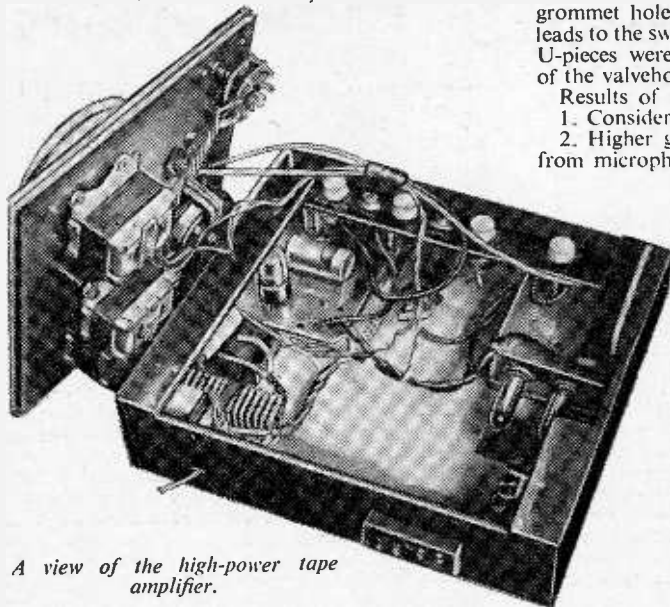

Fig. 1.—This shows the improvement in the magic-eye circuit.

Fig. 2.—The position of the new stage on the side of the chassis.

wired as shown (Fig. 3) with a 25 μ F capacitor and a 1K Ω resistor to supply the correct cathode bias on both recording and playback. The grid circuit (tone



A view of the high-power tape amplifier.

control, etc.) is left as in the original circuit.

Switch wafer S1.B when switched to "Playback" connects the anode coupling capacitor to the L63 control grid; on playback the 6U5 magic-eye is inoperative. The anode and cathode loads of the L63 must be matched to 1 per. cent. for correct phase splitting conditions. The grids of the EL84's are permanently wired via their respective 0.1 μ F capacitors to the anode and cathode of the L63.

Recording

When recording the output stages must be "deadened" for obvious reasons, so the contact on S1 switch (S1.D) is now used to earth the L63 grid when switched to record (This contact previously altered the bias on the cathode of V3 when it was the phase-splitter.)

The purpose of the 200pF capacitor is to equalise the loading on the anode and cathode of the L63, as the anode capacitor feeds the EL84 with the oscillator winding in its grid circuit. This 200pF balances the cathode output to the remaining EL84 closely to the anode circuit. The circuit shown in Fig. 3 also comprises the new magic-eye circuit.

As stated previously the valveholder is bolted to the chassis on the magic-eye side. The tag board is mounted below this, also to the chassis. A small grommet hole is made, as shown in Fig. 2, for the leads to the switch, etc. The well-known "Meccano" U-pieces were found very useful for the mounting of the valveholder and tag board.

Results of the addition of this stage are :

1. Considerably more output (12 watts).
2. Higher gain is now available for P.A. work from microphone, gramophone, etc.

The noise-level is higher due to valve hiss but it is only apparent when the gain is at maximum, and if programme material is being fed through the amplifier at maximum gain the background noise just cannot be discerned.

NOTE.—If this extra stage is added, a 300pF capacitor must be connected from the EF86 grid to chassis, and a 200pF across the anode side of the volume control to chassis to prevent instability.

Correction

An error crept into the circuit on page 162 of the March issue, Fig. 1.

In this circuit R13 is shown grounded to chassis and it should terminate at the junction of R15 and R16. C8, the bass-boost capacitor, should still be taken to chassis to maintain efficient working of the tone-control circuit.

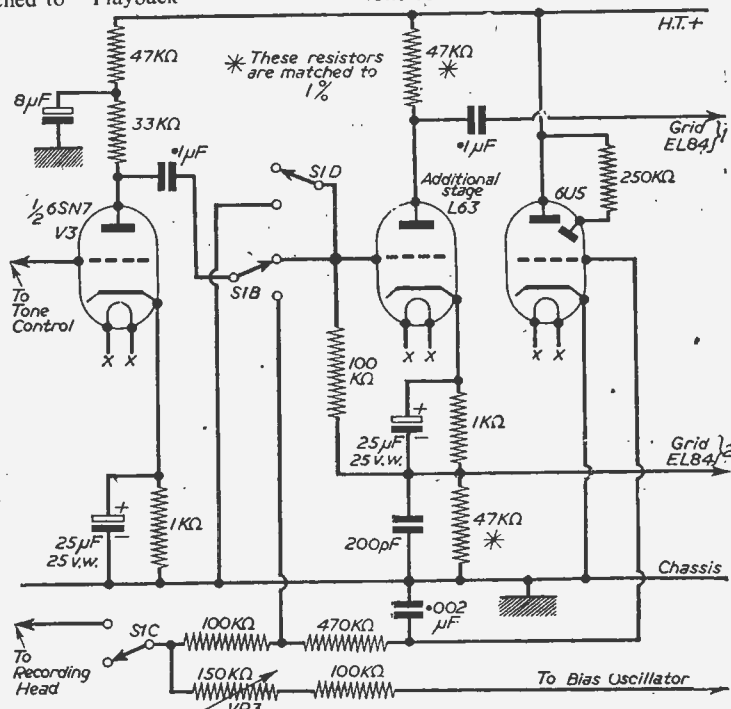

Fig. 3.—The position of the additional stage in the amplifier circuit, including the circuit shown in Fig. 1.

BRIMAR

TRIPLE-TESTED

Transistors

save space power & weight

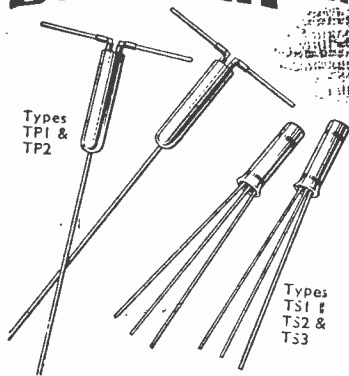

Types TP1 & TP2

Types TS1, TS2 & TS3



Types TJ1, TJ2 & TJ3

These long-life transistors in your circuits will save space and power and incidentally save weight. Exhaustive tests by our unique triple-test process have proved their reliability over a long period.

Their small size and low consumption permit the design of light, compact equipment and, since the cases are of metal, there is little danger of accidental fracture.

The BRIMAR TP1 and TP2 are point contact n type, germanium transistors. Type TP1 may be used in control and switching circuits at frequencies up to 100 Kc/s and will work consistently and reliably within this range. Type TP2 may be used as an amplifier or oscillator at frequencies up to 2 Mc/s. Collector dissipation 150 mW max. at 20° C. The BRIMAR TS1, TS2 and TS3 are p.n.p. alloyed junction transistors intended for use in low frequency applications up to 500 Kc/s. These transistors are fully hermetically sealed. They are thus immune from the effects of humidity and noxious atmospheric conditions. The collector dissipation of these types is 50 mW at 20° C. The TJ1, TJ2 and TJ3 are similar to the TS1, TS2 and TS3, but have a collector dissipation of 200 mW at 20° C. and are somewhat larger in size.

Send for datasheets of these transistors to

Standard Telephones and Cables Limited FOOTSCRAY, SIDCUP, KENT Footscray 3333

HENRY'S

(RADIO LTD.)

CATHODE RAY TUBES
(Brand New)
VCR97 (slight cut-off) 15/-
VCR97 guaranteed 40/-
full T.V. Picture ... 35/-
VCR517C, guaranteed 40/-
full T.V. Picture ... 35/-
VCR139A, guaranteed 35/-
T.V. Picture ... 35/-
VCR138A (with Screen) ... 35/-
3BP1, guaranteed full T.V. Picture ... 30/-
Carr. & Packing on all tubes, 2/-.

"33" WALKIE-TALKIE SETS
Special offer of above set, complete with 5 valves, 4 AP12 and ATP4, with circuit. Range 1.4 to 9 mc/s. These sets are not guaranteed but are serviceable. 25/-
Junction box 2/6 extra.

Junction transistors PNP type, ideal for local station receiver, transistor voltmeter, signal tracer oscillators, experimental work, etc. Made by well-known manufacturer. 10/- each. Buy whilst available.

62A INDICATOR UNIT
Containing VCR97 with Mu-metal screen, 21 valves: 12-EP50, 4-SP61, 3-EA50, 2-EB34. Plus pots., switches, H.V. and resistors, Muirhead S.M. dial, double deck chassis and crystal. BRAND NEW ORIGINAL CASES. 67/6. Carriage 7/6.

INDICATOR UNIT TYPE 182A
Unit contains VCR517 Cathode Ray gun, complete with Mu-metal screen, 3 EP50, 4 SP61 and 1 5U4G valves, 9 wire-wound volume controls and quantity of resistors and condensers. Offered BRAND NEW (less relay) at 67/6 plus 7/6 carr. Radio Constructor scope circuit included.

VR91A The Selected EP50. Brand New Red Sylvania original cartons. 10/- each, 90/- for ten.

U.S.A. INDICATOR UNIT TYPE RC928A
In black crackled cabinet 14 1/2 in. x 9 in. x 9 in. Complete with 3BP1 C.R. Tube, shield and holder, 2 6SN7GT, 2 6H6GT, 1 6X5GT, 1 2X2, 1 6G6, V controls, condensers, etc. Ideal for scope. Brand new, 65/-, carriage paid.

MINIATURE I.F. STRIP TYPE "373" 9-72 MEG.
Brand new miniature I.F. Strip size 10 1/2 in. x 2 1/2 in. x 3 in. high. Valve line-up: 2 EP92; 3 EP91 and EB91. With Circuit. Price (less valves), 7/6. P.P. 1/6.

We have over 50,000 American and B.V.A. valves in stock. LATEST TYPES NOW IN STOCK

EBC41	10	-UBC41	10	-PL82	10	-12AT7	9	-EF85	10	-6DL6	10	-EY51	12	-DK40	10	-PY81	10	-12AU6	9	-EP89	10	-12AP96	10	-EP41	11	-EP80	10	-6EM80	10	-12BA9	9	-ECF82	15	-12DF6	10	-EL41	11	-EABC60	6X4	8	-12BE6	10	-PABC50	10	-EM34	10	10	-PY82	10	-12AH8	12	-6	15	-ECC84	15	-UL11	10	-ECC85	10	-PCC84	12	-6	15	-6AU6	9	-6	10	-UY41	11	-EP30	10	-PCF82	10	-12	6	-6AUG	9	-6	10	-UP41	11	-ECL80	12	6	-PCF80	15	-117Z3	8	6	12	6	-ECL80	12	6	-EBP80	12	AX7	10	-ECH42	12	6	12	6	-PL81	12	6	-12AT6	8	11	6	-DK96	10	12	6
-------	----	--------	----	-------	----	--------	---	-------	----	-------	----	-------	----	-------	----	-------	----	--------	---	-------	----	---------	----	-------	----	-------	----	--------	----	--------	---	--------	----	--------	----	-------	----	---------	-----	---	--------	----	---------	----	-------	----	----	-------	----	--------	----	----	----	--------	----	-------	----	--------	----	--------	----	----	----	-------	---	----	----	-------	----	-------	----	--------	----	-----	---	-------	---	----	----	-------	----	--------	----	---	--------	----	--------	---	---	----	---	--------	----	---	--------	----	-----	----	--------	----	---	----	---	-------	----	---	--------	---	----	---	-------	----	----	---

OBsolete VALVES IN STOCK
L.P2 3/6, VP2 8/6, FC135/C, FC138 10/-, DDL4 5/-, 251V 5/-, 210LF 3/6, SP2 8/8, 10/-, MS/PEN, PENDD, MLA 7/6, 12 4, VP2B 8/6, TDD2A 7/6, 4020 12/6, 215SG 4/-, TP22 8/-, 8 6, U10 8 6, 42SPT 6/-, MU14 8/6

SPECIAL REDUCTION FOR SETS OF VALVES
1AT6T, 1N6CT, 1N6GT, 1A50T (or 1G5GT or 3Q5GT) ... 40/- Set
10 EP50 (Ex-Brand New Units), 5/- each ... 45/-
10 EP50 (Red Sylvania ex-new units), 5/- each ... 45/-
6K8G, 6K7G, 6Q7G, 5Z4G, 6V6G ... 37/6
1R5, 1R5, 1T4, 1R4 or (3R4 or 3V4) ... 27/6

SEND 3d. for 26-PAGE ILLUSTRATED CATALOGUE

CRYSTAL MICROPHONE INSECTS



Ideal for tape recording and amplifiers. No matching transformer required.

QUARTZ CRYSTALS
Type FT243 Fundamental Frequencies, 2-pin 1/2 in. Spacing. 120 Types: 5675 Kcs to 2650 Kcs (Channel 270.389). (In steps of 25 Kcs.). 80 Types: 5706.667 Kcs to 8340 Kcs. (Channel 0.79). (In steps of 33.333 Kcs.).

BRAND NEW AND GUARANTEED, 10/- each. Complete sets of 80 and 120 Crystals available.

Type FT241A 54th Harmonic
2-1/2 in. Spacing
80 type in the following frequencies:
20 Mc/s - 27.9 Mc/s.
(in steps of 1 Mc/s.)

BRAND NEW AND GUARANTEED, 7/6 each. Complete Sets of 80 Crystals Channel 0.79 available. 200 Kcs., 10/- each. CRYSTAL HOLDERS, 1/3 each 10/-, Discount on all orders of £5.

TRANSMITTING TOPICS

CHOOSING AND USING MODULATOR VALVES

By O. J. RUSSELL, B.Sc.(Hons.), G3BHJ



DESPITE the allures of many weird and wonderful modulation systems (usually very ancient ideas resuscitated), which are guaranteed to "modulate a kilowatt" with a microwatt of audio, the anode modulator remains a very popular standby. In fact, as has previously been described in these pages, there are points for and against anode modulation and the various "efficiency" systems. However, in the case of amplitude modulation generally, with the exception of the Woodyard-Terman system of efficiency modulation, there is only anode modulation to give the full R.F. carrier output when the P.A. input is legally restricted. Moreover, anode modulation is generally straightforward and free from the critical R.F. adjustments needed by some other systems. Many amateurs, therefore, regard anode modulation as the Rolls-Royce of modulation systems. A little old-fashioned, perhaps, compared with single sideband circuiting, but easy to get going.

However, there are points to be watched with anode modulation if good results are to be obtained with the minimum of trouble. Selection of modulator valves and their operating conditions is not to be undertaken lightly. Various types of operating conditions need varying types of care if good results are to be obtained. The use of a pair of valves that can give a rated output in a modulator is not to say that this output will be obtained, unless the correct operating conditions are observed. Moreover, it is when the highest powers are needed for a 150 watt rig that the usual modulator valves need the greatest care if the full output is to be obtained.

Easiest condition of all, of course, is the Class A modulator condition. A Class A triode is not critical of load conditions, gives excellent quality and does not readily overload. However, Class A triodes are seldom used, for their efficiency is low and a large grid swing is needed to drive them. To obtain more than a watt or two of power a large valve is needed, as the best efficiency is around 25 per cent., so that this is very wasteful of power. Occasionally, a mammoth power-triode is used to give 20 watts of audio, but this is rare. Even if push-pull is used the efficiency is still too low for use on high-power rigs, as around a quarter of a kilowatt of H.T. power would be needed to obtain 75 watts of audio from a Class A triode modulator! Accordingly triode modulators are only used to provide a small amount of audio power, such as needed for efficiency systems such as the "clamp tube" type, and very seldom for anode modulators.

For small anode modulators the Class A pentode or tetrode is quite useful. For top band rigs, a single 6V6, 6AQ5 or 6BW6 will give just over 4 watts of audio, sufficient to anode modulate a topband P.A. running 8 to 9 watts input. The pentode or tetrode requires a small grid swing, and is reasonably efficient, so that H.T. power is not unduly wasted. The single

6L6 represents about the useful limit for a single valve Class A modulator, as some 11 watts may be obtained from a single tube. Many transmitters have done useful work with a single 6L6 modulator, as a 20-watt P.A. may be fully modulated by a single 6L6. The writer has made many QSOs using a single 6L6 modulator. Moreover, as previously described, Class A valves may be readily paralleled to give double the audio output and thus modulate twice the R.F. stage input. Thus two 6L6s will enable 40 watts of P.A. input to be modulated.

However, a 6L6 will only give 11 watts of audio if operated under the correct conditions. The table gives the pertinent details. The 6L6 should be carefully matched into the correct load, preferably by using one of the multimatch modulation transformers. Deviation from the stated conditions will prevent the full output from being obtained. Thus, even with straightforward Class A operation, the lesson is learned that pentodes and tetrodes must be operated correctly if optimum results are to be obtained.

As soon as power inputs exceed the levels where a single small tube will give adequate audio, it is much more convenient to change to push-pull operation.

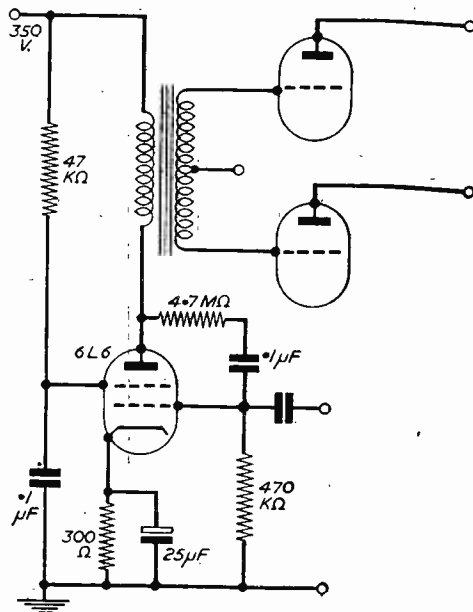

Fig. 1.—A 6L6 driver stage incorporating negative feedback. This enables the driver to cope with the varying impedance of the grids of a Class AB or a Class B output stage.

The distortion cancelling properties of push-pull circuits, plus the fact that the modulation transformer can be made more economically, makes push-pull the logical choice for higher power modulators. However, it is here that complications arise. The written circuits of various push-pull arrangements look the same. However, the requirements of the particular operating conditions of the modulator valves greatly affect the practical features of these circuits.

Simple Operation

First the modulator valves may be operated in Class A. Generally, this is the least troublesome and simplest mode of operation. The power output from a pair of Class A valves is slightly more than double that of one of the valves. Operating conditions are not very critical, and the power pack need not have very good regulation, as the load current drawn by the modulator valves is constant under modulation. Thus a pair of 6L6s may give some 25 watts in Class A push-pull.

When we need to obtain more power output without paralleling modulator tubes, or without departing from easily obtainable types, more efficient modes of operation of the tubes are needed. Class AB operation is one such method. In "Class AB1" operation, the modulator valves are operated with increased bias, so that the current drawn under zero signal conditions is lower than normal Class A conditions. Thus the dissipation is reduced, and generally with Class AB operation considerably more power output may be obtained than with the same valves in Class A. However, complications now occur, as the valves draw a varying current depending upon the audio

signal, so that unless the power pack regulation is good, correct operation will not be obtained, distortion will increase and peak power output will be lost. Moreover, the load matching becomes more critical. The primary requisite for Class AB1 operation is good power pack regulation, so that both the anode and screen voltages remain reasonably constant. The grid drive needed is only a little greater than the Class A condition, and small receiver type push-pull step-up transformers may be used. In fact, the old "QPP" intervalve transformers used to drive a QPP stage find ready application in Class AB1 modulator stages for coupling the signal to the grids of the output stages. It is also possible to parallel valves to double the output, provided care against parasitic oscillations is observed.

In the Class AB2 modulator condition, the valves are driven so hard that the grids operate in the positive region on signal peaks. This enables greater output than Class AB1 to be obtained from a given pair of valves. However, a price must be paid for this increase in output. When the grids become positive they draw current and absorb appreciable power from the driving stage. When the grids are negative they draw negligible power, and are, in effect, very high impedances. When driven positive the grids become very low impedances of the order of a few hundred ohms. Thus in the Class AB2 condition the driving stage must be capable of supplying some power to the modulator grid circuits. Also the driver must be able to cope with the fact that it drives into an impedance that is very high over part of the swing, and becomes very low on the peaks of the swing. Most driver stages cannot do this on their own,

(Continued on page 337)

Valve	Service	VA	VSC	IAQ	IAS	ISQ	ISCS	Bias Volts	Watts Output	Load Resistance
6V6	Class A	250	250	45	47	4.5	7	11	4.5	5,000
6AQ5	Class A	250	250	45	47	4.5	7	11	4.5	5,000
6BW6	Class A	315	225	34	—	2.2	—	11	5	8,500
6L6	Class A	350	250	54	66	2.5	7	20	11*	4,200
6V6	PP AB1	285	285	70	92	4	13.5	28	14	8,000
6BW6	PP AB1	285	285	70	92	4	13.5	28	14	8,000
6L6	PP Class A	250	250	120	140	10	16	15	14	5,000
6L6	PP AB1	360	270	88	100	5	17	22.5	24	9,000
6L6	PP AB2	360	225	78	142	3.5	11	18	31	6,000
6L6	PP AB2	360	270	88	205	5	16	22.5	47	3,800
807	Class A	500	200	50	—	16	—	18	11.5	6,000
807	PP AB1	500	300	100	119	2.5	16.5	22.5	32.5	9,000
807	PP AB1	600	300	80	150	1.5	17.5	27.5	47.5	10,000
807	PP AB2	500	300	100	265	2	27	78	75	4,500
807	PP AB2	600	300	60	200	1.5	21	30	80	6,400
807	PP AB2	750	300	60	240	5	10	32	120	6,950
807	Triode - Class B	750	—	15	240	—	—	0	120	6,650
6146	PP AB1	400	190	62	228	2.4	25	40	50	4,000
6146	PP AB1	500	185	56	214	2	25	40	70	5,000
6146	PP AB1	600	190	26	200	1	23	45	82	7,000
6146	PP AB2	400	175	32	232	1	18	41	62	3,700
6146	PP AB2	500	175	26	242	0.6	18	44	83	4,600
6146	PP AB2	600	165	22	206	0.6	17	44	90	6,800
6146	PP AB2	750	165	35	240	0.6	21	45	130	8,000

VA = Anode volts.
VSC = Screen volts.

IAQ = Anode current at zero signal.
IAS = Anode current at full output.
ISCS = Screen current at full output.
ISQ = Screen current at zero output.

Pushpull figures are those for both valves.

Notes by
E.M.I. Institute

NEW! THE PRACTICAL WAY

of learning RADIO • TELEVISION • ELECTRONICS
AMATEUR S.W. RADIO • MECHANICS • PHOTOGRAPHY • CARPENTRY • ETC.

2-Stage receiver

Amplifier and Oscillator experiments

3-Stage T.R.F. Receiver

Special Units

Instructional lesson manuals

Complete 5-valve Superhet 3-waveband receiver suitable for A.M. or F.M. reception

DO IT YOURSELF!
IN YOUR OWN HOME — IN YOUR OWN TIME

An entirely new series of courses designed to teach Radio, Television and Electronics more quickly and thoroughly than any other method. Specially prepared sets of radio parts are supplied and with these we teach you, in your own home, the working of fundamental electronic circuits and bring you easily to the point when you can construct and service radio receivers, etc.

Whether you are a student for an examination; starting a new hobby; intent upon a career in industry; or running your own business; — these Practical Courses are ideal and may be yours at very moderate cost.

With these outfits, which you receive upon enrolment and which remain your property, you are instructed how to build basic Electronic Circuits (Amplifiers, Oscillators, Power Units, etc.) leading to designing, testing and servicing of complete Radio and Television Receivers.

Photograph of E.M.I. factories at Hayes—our industrial background.

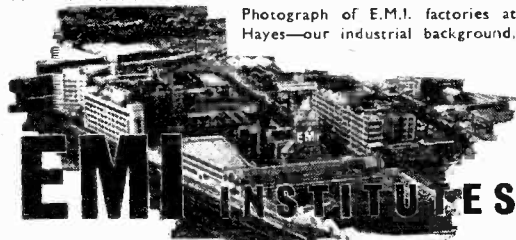

An Educational Organisation associated with the E.M.I. group of Companies including: 'HIS MASTER'S VOICE', COLUMBIA, etc.

OTHER COURSES WITH PRACTICAL EQUIPMENT INCLUDE: RADIO (Elementary and Advanced) • TELEVISION MECHANICS • ELECTRICITY • CHEMISTRY • PHOTOGRAPHY • CARPENTRY.

Also Draftsmanship • Commercial Art • Amateur S.W. Radio • Languages • Simple Electrical Repairs in the Home • Painting and Decorating • Etc. • Etc.

With these outfits, you are given instructions that teach you the basic principles in the subject concerned.

NEW TELEVISION COURSE

including a complete set of equipment dealing with the design, construction and servicing of a high quality television receiver.

COURSES

(with equipment) also available in many other Engineering subjects.

COURSES FROM 15/- PER MONTH

To E.M.I. INSTITUTES,
Dept. 32, 43 Grove Park Road,
London, W.4.

NAME _____

ADDRESS _____

SUBJECT(S) OF INTEREST _____

JULY (We shall not worry you with personal visits) _____



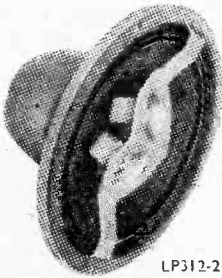

LP312-2

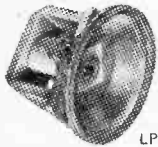

LPH65

EXPAND AND

Laboratory Balanced. The TSL LORENZ LP312-2 is a main bass 12in. diaxial speaker combined with two LPH65 electro-magnetic high frequency TREBLE units permanently mounted coaxially across the front of the main bass speaker at such an angle to give full spherical binaural response. All are laboratory balanced and matched for perfect tone with a frequency range of 20 cycles to 22,500 cycles essentially level output. To ensure level frequency response the voice coils of the two treble speakers are fed through a specially designed crossover network which balances the frequency response of the three speakers as a combined unit.

IMPROVE ANY

The TSL LORENZ LPH65 is the basic treble speaker used in the TSL LORENZ Sound System. Round in shape to ensure smooth melodious sound the plastic cone is fully tropicalised. Special features are the super high flux density magnet of 17,500 gauss and non-perforated back plate.

SOUND SYSTEM

SPECIFICATION LP312-2

IMPEDANCE 15 ohms; **FREQUENCY RANGE** 20-22,500 c/s; **POWER RATING** 25 w.; **PEAK POWER RATING** 40 w.; **DIAMETER** Bass 12 1/2 inches Treble 2 1/2 inches; **DEPTH** Bass 7 1/2 inches Treble 2 inches; **BAFFLE OPENING** 10 1/2 inches; **SPEECH COIL DIAMETER** Bass 1.5 inches Treble 1/2 inch; **FUNDAMENTAL RESONANCE** Bass 20 c/s Treble 1,600 c/s; **FLUX DENSITY** Bass 17,500 gauss Treble 17,500 gauss; **INTERMODULATION PRODUCTS** under 0.5%; **CROSSOVER FREQUENCY** 2,000 c/s; **FINISH**, Grey and blue vitreous anti-corrosion stove enamel. **RETAIL PRICE, £14.19.6.** (Not subject to Purchase Tax.)

Exclusively distributed throughout Great Britain and the Commonwealth by:-



Details of Bass-Reflex enclosures for the TSL LORENZ LP312-2 may be obtained from:-

TECHNICAL SUPPLIERS LTD., HUDSON HOUSE, 63, GOLDHAWK RD., LONDON, W.12.. Tel: SHE 2581, 4794.

SUPER HIGH FIDELITY THIS YEAR

Let your ears be your judge... crisp, clear, natural reproduction without coloration with TSL LORENZ speaker units. Ten years ahead in engineering and design this speaker unit will enable you to design and build up a sound system in your own home which will truly add the miracle of LIFE to the magic of music...

No Extra Cost. You get these extra features at no extra cost with every TSL LORENZ Sound system... Greater output and more sensitivity... heavy duty oversize speech coil... Super high flux magnet... Permanently flexible self-damped cone... Multi-parameter cone fully tropicalised... Sealed in air gaps... built-in centralising device for perfect gap alignment.

Improve your own H.F. Sound System. For those devotees of high fidelity who possess bass speakers fitting one or more LPH65 treble units will greatly extend your range of super fidelity reproduction. They are, without a doubt, the most sensitive and efficient treble reproducers research has revealed to date. The non-perforated back plate ensures that the LPH65 can be used with any other speakers irrespective of make or type without interaction taking place.

SPECIFICATION LPH65

HIGH FREQUENCY CONE-HORN TYPE TREBLE UNIT

IMPEDANCE 5.5 ohms; **FREQUENCY RANGE WITH SUITABLE HIGH PASS FILTER CONDENSER** 2,000-22,500 c/s; **POWER RATING AS A SINGLE UNIT** 3 w.; **PEAK POWER RATING AS A SINGLE UNIT** 5 w.; **DIAMETER** 2 1/2 inches; **DEPTH** 2 inches **BAFFLE OPENING** 2 1/2 inches. **PRICE, 3/9/6.** (Including Purchase Tax.)

VALUES

R71. Chassis (less valves). 100-124 mc. V.H.F. with circuit, 10/-.

Spot Lamps (less bulb). 7/6.
T.18 Set, Tx Section, less meter and Valves, 7/6.

B3 VAC Pumps. New, £1.

Landing Lamp. 24 volt motor and lamp, new, £1.

Rotary Switches. 11 way 1 pole. 5/-; 11 way 1 pole, 2 bank. 5/6.
3 pole 4 way, 4/6. Toggle Type D.P.D.T., 3/6; D.P.S.T., 1/3.
24 volt Miniature Motors, 9/6 only.

Dome Fitting (SBC) Suitable for interior lamp, Caravan or Boat, etc., 4/-. New in boxes.

Packard Bell Amplifier. New valves and handbook, 12/6 each.

Germanium Diode, 2/- each.

Relays. G.P.O. type, etc. Large stock all types. Bulkhead fittings. weatherproof (alloy case) with switch, £1.2.6. L.R. Headphone, 7/6 pair. Londec 230 A.C. Relays, 8/6.

EF36	4/-	ECC81	9/-	1R5	8/6
EF50	4/-	ECC82		EF37A	9/-
EF54	5/-		10/6	PL81	12/6
EF80	10/6	ECC83		PL82	9/6
EF39	7/6		10/6	PL83	10/6
SP1	2/6	ECL8011		EZ41	8/6
SP4	2/6	ECC85	9/6	EZ80	8/6
X65	10/-	EA50	2/-	D1	2/-
PY80	9/6	Y63	6/6	VP23	5/-
PY81	9/6	EY51	13/6	6X5	7/6
KT33C	9/-	6X4	6/9	5Z4	8/6
6V6	8/6	807	7/-	5U4	8/6
EF91	8/6	6L6	11/-	80	8/6
12SH17	7/-	12A6	7/6	12I5	5/-
6K7	7/-	6SK7	4/6	6SJ7	7/6
9001	3/9	6K8G	11/-	6J5	5/-
955	5/-	6AK5	7/-	954	3/-
6SN7	8/-	6AC7	6/-	6AL5	7/6
6N7(m)	7/-	6SL7	8/-	6SA7	7/6
6C4	7/-	6AG7(m)	6/6		6/-
1S5	8/6		9/-	1S4	9/-
ECC31	7/-	1T4	7/-	3S4	8/6

VINERS

(MIDDLESBROUGH)

26, EAST ST., MIDDLESBROUGH

TEL: MID 3418

R1155

Covers 18.5/7.5 mc, 7.5/3.0 mc, 1,500/600 KC, 500/200 KC. 200/75 KC. Complete with valves.

FIRST £6 GRADE

Carriage 10/-.

Power unit for use on 230-250 A.C. main. Complete with 2 valves on 8 x 6 Chassis.

£4 Carriage 5/-.

TA12G TX.

Reduced. This Month's Bargain.

£4. 10. 0

RF 24 Units. Brand new in makers' cartons, 15/-.

PVS Sleeved Wire, 22 s.w.g., 10 colours, 2d. per yard. X-RAF Heavy Duty 24 volt 60 amp. Switch, 1/6. Transformers, all 230 v. A.C., 50 c.p.s. mains, 14/20 volt 20 amp., £3. 14/17 volt 20 amp., £3. 3.5/9 v./17 v. 4 amp., £1.2.6. 9 v./17 v. 1.5 a., 13/6. 350-250-0-250-350 v. 6.3 v. 3 a., 4 v. 2 a., £1. Condensers Electrolytic 450 volt wkg. 8 mfd., 2/6. 8+8, 3/6. 16 mfd., 3/-, 16+8 mfd., 3/9. 16+16, 4/6. 32+32 mfd., 6/-. CONDENSERS, Assorted, 100 for 15/-. Ass'd Resistors, 1/2, 1/2, 1, 2 watt. All our selection. R.E.P. Coil Stock, also Denco, Osmor High Stab Resistors, 2%, 1/-; 1%, 1/6. Welwyn Vit. Resistors, 5 watt, 1/6. Potentiometers, all valves, to 2 meg., 2/6 each.

unless the secondary of the driving transformer is loaded by resistance, and a special driver transformer is needed. Negative feedback applied to the driving stage also helps (see Fig. 1) to enable the grids to be swung positive without causing distortion in the driving stage. Note that if we use an ordinary push-pull intervalve transformer, this will *not* match into the low load presented by the positive grids. Thus the driver will swing the grids up to zero volts, but the instant the grids draw current, the grid driving

Valve Types

So far we have been considering *how* to get results from the various types of modulation condition. Now we can consider *what* various valves can do. The 6L6 has been for a long while the favourite modulator tube in very many amateur rigs, so the table of 6L6 operating conditions may be useful. The ubiquitous 807, close relative of the 6L6, is also very popular as it is readily available on the surplus market. Here we might remind the reader of the "zero bias" operation of the 807. The tube is triode connected as shown in Fig. 2, and needs no grid bias, as it draws very little current with this connection. However, under drive so that the grids are swung positive it can draw the heavy peak currents demanded for Class B operation. As the grids draw grid current when a signal is present, they present a more uniform load than Class AB2 and Class B stages where the tubes are biased heavily negative; so that here the driver valve operates under easier conditions into a low but more constant load. It is, of course, to be understood that battery bias, or bias from a low-impedance power pack, is necessary for Class AB2 and Class B stages. Cathode bias is not permissible. However the small deaf aid and portable radio miniature batteries are ideal for providing the bias requirements of such modulators.

The "zero bias" 807 connection is a useful dodge to remember. There are, however, other points worthy of note in selecting modulator valves. There are several new types appearing that offer useful advantages. Thus the 6146 (now available from Mullard) is a case in point. This tube cheerfully gives 120 watts of audio in Class AB1, so that it needs very little drive. In fact, due to its rather unusual characteristics, this tube gives very little more output for the Class AB2 condition. By generously under-running it, and thus assuring long life, it will happily provide the 75 watts or so needed to modulate a 150-watt rig. Oh yes . . . the "or so" remark is intentional. Don't forget that the screen circuit of a P.A. stage needs some audio power, say one, two

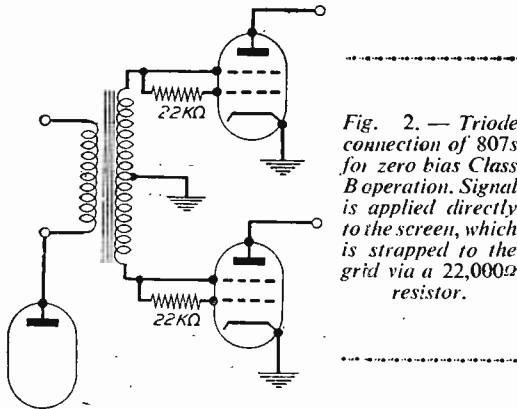

Fig. 2.—Triode connection of 807s for zero bias Class B operation. Signal is applied directly to the screen, which is strapped to the grid via a 22,000Ω resistor.

waveform will be savagely clipped. Practically this means that such an arrangement will be incapable of driving the valves into the true Class AB2 condition. Thus the provision of two modulator valves capable of a rated high output, supplying them with the correct anode and screen voltages, and matching them into their correct anode load, will be nullified if the driver stage has not the correct driver transformer. The audio output will be restricted, and modulation will fall short of the 100 per cent. condition.

Transformers

The pre-war receiving type "Class B" driver transformers will often be found suitable for use as driver transformers for Class AB2 modulators, and they are often sold for a few shillings in junk shops. However, suitable transformers may be purchased from Partridge, Woden and Parmeko. One useful transformer is the Ferranti OPC1 output transformer. This was a pre-war push-pull output transformer. However, for Class AB2 driver stage use it is used backwards. The push-pull windings are used to feed the modulator grids, while the output winding (originally intended for use with a high-resistance speaker) is used as the primary for the anode of the driver valve. These again are a transformer occasionally met with in junk shops, and they are obtainable there for a few shillings.

The Class AB2 modulator definitely needs power to drive the grids, and a small tetrode or pentode is often used for the driving valve. A 6V6 will drive a pair of 6L6s, while a single 6L6 will easily drive most modulators into Class AB2. For both Class AB2 and Class B, the power pack needs good regulation, and the H.T. and screen volts need to be constant to about 5 per cent. from idling to full signal conditions if good results are to be expected. For Class B conditions, a Class B driver transformer is needed, and usually a single 6L6 will provide enough drive power for swinging 6L6s, 807s, etc., into Class B.

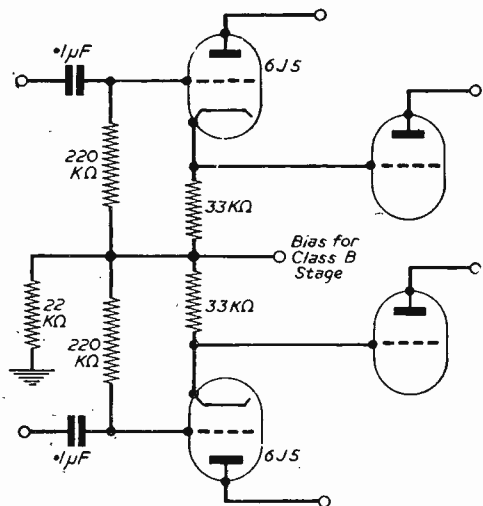

Fig. 3.—The "cathode drive" system for driving Class B grids from the low-impedance cathode output of push-pull triodes.

o: even three watts. Moreover a modulator transformer is *not* perfect, and a little audio power is dissipated in the core and copper losses of the transformer. Assume 10 per cent. of the audio is lost in the transformer and you will see that a few watts of audio power in hand from the modulator over and above the theoretical minimum are needed in a practical modulator. Thus a 150 watt rig may need some 85 watts of audio from the modulator tubes before it can overmodulate the P.A.

At the other end of the scale a useful thing to know is that the humble 12AX7 can be used as a Class B valve, and will give 5 watts of audio. Provided, of course, we use a Class B driver transformer and supply the fraction of a watt grid drive power that it needs. This is *one* way of modulating a top band rig, and designs have in fact been published for *mains* operated 10 watt rigs with a 12AX7 modulator. However, a more useful application of a Class B 12AX7 modulator would be for a phone portable rig. Usually phone is a headache on these portable field days and 2-metre V.H.F. jaunts due to the power drain. However, *if* the 12AX7 modulator is used, and supplied from auxiliary dry batteries, an economical modulator results. Due to the intermittent load compact miniature type batteries are quite feasible. Moreover, a pair operated strapped in parallel push-pull would be capable of 10 watts output, and this would swing a 20 watt P.A. while the *average* current drain would still represent on speech only some two to three watts continuous drain. This, of course, recalls the old-time days of battery Class B stages capable of high output from

battery supplies. Moreover, this type of application of the miniature "powerhouse" button based tubes has also been developed into an ingenious "positive drive" use of a pair of 12AU7s in a more complex circuit also capable of giving high audio outputs.

Here again a final word on that "drive" question. One ingenious means of overcoming the need for a special driver transformer for Class B modulators is the "cathode drive" circuit (Fig. 3). Here the grid drive is taken from the cathodes of a pair of driver valves. The low impedance of the cathodes matches very nicely the low impedance of the positively driven grids. Such an arrangement does need, of course, rather more gain, as the driver grids themselves need adequate swing to ensure enough drive voltage being developed at their cathodes. However, this is not usually a problem, and the arrangement does save the necessity for a special driver transformer. Incidentally, it is quite feasible to put a transformer in the cathode of, say, a 6L6, using a small ratio so as to match into the modulator grids. As the output impedance of the cathode is low many small transformers are quite suitable, provided the secondary is of low resistance, and a specially designed driver transformer is not absolutely necessary with this arrangement. However, by now the main point has been proved . . . that it is possible to obtain many varied results from the same pair of modulator tubes. The moral is that the particular requirements of the method of operating are important, and satisfaction is only to be obtained by observing all the precautions necessary.

A New Electrostatic Loudspeaker

QUALITY enthusiasts have for long been interested in the extension of the reproduced range of frequencies so that extreme "top" may be reproduced, and one of the most satisfactory types of "tweeter"—or high-note reproducer—is the electrostatic unit. Various models of these have been available from time to time, and we recently had the opportunity of hearing a new model produced by H. J. Leak & Co., Ltd., well known for the original Leak amplifier and pick-up. The new speaker was first shown to the public at the Audio Fair and has since been demonstrated at the British Sound Recording Association's exhibition.

For the benefit of those readers who are not familiar with the design of this type of speaker, it may be mentioned that in the electrostatic model the essential difference is that the driving force is applied evenly, or almost evenly, over the entire surface of the vibrating element. This is not a cone, but a very light plastic surface which is metallically coated so that it can sustain an electrostatic charge. At the present stage of the art it does not appear possible to produce electrostatic loudspeakers which go down to the very low notes without using very large areas, which means that the loudspeaker becomes too large to be acceptable in a home. In the new Leak high-quality set-up a 10-watt amplifier is used, with an electrostatic loudspeaker which takes over from about two octaves above middle C. For the frequency range below that a 15 in. moving-coil loudspeaker is employed. Full details of the development cannot, at the moment, be given because of the patent situation.

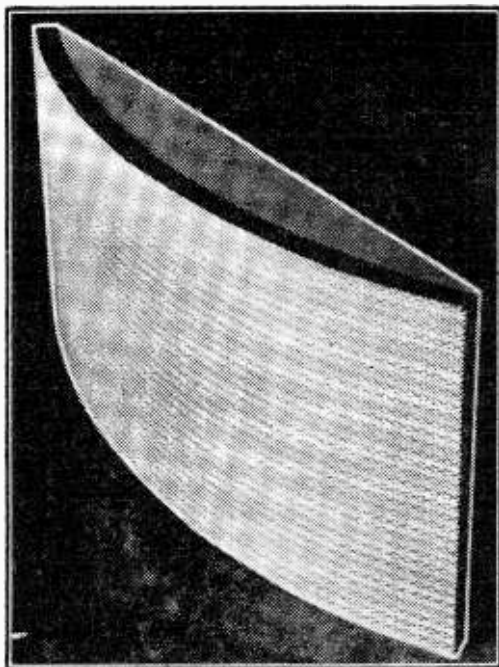

The fully developed balanced push-pull electrostatic loudspeaker.

STERN'S "F.M." TUNING UNIT

A 5-valve Tuner incorporating the latest Mullard Permeability Tuning Heart and a "Magic Eye" Tuning Indicator.

THE COMBINED AM-FM TUNER is precisely similar in appearance to the above and incorporates 7 valves. It provides complete coverage of the F.M. Transmissions and the MEDIUM WAVEBAND thereby giving a good selection of foreign stations.

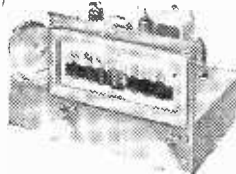

STERN'S "HIGH QUALITY" 8-10 WATT AMPLIFIER

Designed for High Quality reproduction up to an output level of 10 watts, having 6V6's in Push-Pull and incorporating negative feedback. It is suitable for use with all types of Pick-up and most types of microphone and the output transformer provides for use of 3- and 15-ohm speakers.



AN EXCEPTIONAL OFFER FOR CASH ONLY £7.19.6.

The B.S.R. MONARCH 3-SPEED AUTOCHANGER NORMAL PRICE £13/10/-

- Complete with High Fidelity Crystal "Turnover" Head which incorporates separate stylus for L.P. and 78 r.p.m. records.
- A "MIXER" Unit that will autochange on 7in., 10in. and 12in. records.
- Brand New in Maker's Cartons, complete with mounting instructions.

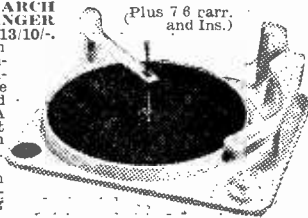

(Plus 7/6 carr. and ins.)

THE B.S.R. MODEL T.U.S. 3-SPEED PLAYER

Supplied complete including the new lightweight "Turnover" type Crystal Pick-up.

PRICE **£4. 12. 6.** (Plus 3/6 carr. & ins.)

or we supply it without the Pick-up but including Turntable.

PRICE **£2. 18. 0.** (Plus 3/6 carr. & ins.)

TWO REALLY GENUINE PRICE REDUCTIONS

A BULK PURCHASE ENABLES US TO OFFER THESE RECEIVER CHASSIS AT SUCH LOW PRICES. Each is BRAND NEW AND FULLY GUARANTEED.

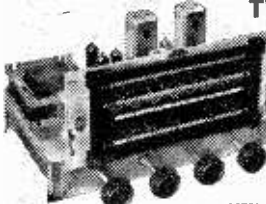

The MODEL AW3-7 A 7-valve 3 waveband Superhet Chassis having a push-pull stage for approximately 6 watts output. Made by a well-known manufacturer and incorporate the latest Osram Valve Line-up of X79-W77-DH77-H77-U78 and

two N78's in Push-Pull. They cover 3 wave-bands 18-50 metres, 190-550 and 800-2,000 metres, and are for operation on A.C. mains 200-250 volts. A Gram position is on the Wavechange Switch.

PRICE **£12.19.6.** (Plus 7/6 carr. & ins.) H.P. Terms: Deposit £8/9/6 and 8 monthly payments of 18/9.

The MODEL B.3 5-valve 3-wave-band A.C. mains Superhet. Designed to the most modern specification, great attention having been given to the quality of production which gives excellent clarity of speech and music on both gram. and radio making them the ideal replacement chassis for that "old radiogram" etc.: Valve Line-up, 6BE6-6BA6-6AT6-6BW6-6X4; coverage: sht. 16-50, med. 187-550, lg. 900-2,000 metres.

PRICE. **£11.11.0.** (Plus 7/6 carr. & ins.) H.P. Terms: Deposit £5.16/- and 7 monthly payments of 19/3.

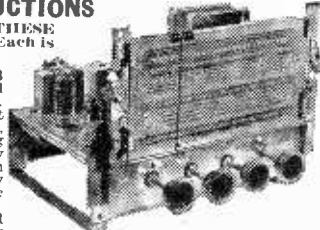

(a) The "COMPACT 5-2" A Two-stage high sensitivity Amplifier having SEPARATE BASS and TREBLE CONTROLS and designed to give up to approx. 5 watts with very pleasing quality. PRICE **£5.15.-** (plus 5/- carr. and ins.)

The Amplifiers are compact and very attractively designed, having a Bronze Gold finish with a fully engraved front panel by which the entire Amplifier is conveniently mounted into a Cabinet, thus occupying no more space than a conventional Tone Control Unit.

(b) The "COMPACT 5-3" A Three-stage version of the "5-2" model, but in this case having an additional stage and incorporating Negative Feedback. PRICE **£6.16.-** (plus 5/- carr. and ins.)

STERN'S "COMPACT 5" AMPLIFIERS

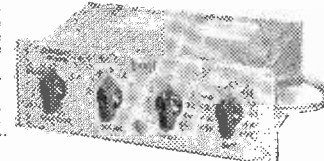

Expressly developed for very high quality reproduction of Gram Records and particularly suitable for high quality reproduction of the FM transmissions.

A separate POWER SUPPLY UNIT to operate with these amplifiers is available for **£2.10.-** (plus 2/- carr. & ins.). Has additional supply available for Radio Tuner, etc.

DESIGNS FOR THE HOME CONSTRUCTOR

THE COMPLETE SPECIFICATIONS OF THE FOLLOWING UNITS ARE AVAILABLE FOR 1/6 EACH. THESE MANUALS ALSO INCLUDE THEORETICAL AND PRACTICAL WIRING DIAGRAMS, AND COMPLETE COMPONENT PRICE LISTS.

The "wire-to-wire" Practical Diagrams are very simple to follow and are drawn for the "inexperienced" Constructor.

• **STERN'S F.M. TUNING UNIT** . . . This is illustrated and briefly described here and can be completely built for **£9.12.0.** It is now available.

• **STERN'S COMBINED AM/FM TUNING UNIT** . . . Precisely similar in appearance to the F.M. Tuner and can be completely built for **£13.0.0.** Will be available early July.

• **THE DENC0 F.M. TUNING UNIT** . . . The complete set of SPECIFIED COMPONENTS to build this can be supplied for **£7.2.9.** This includes the Denco Dial and Drive Assembly. NOTE TO CONSTRUCTORS . . . Where desired our technical staff will, at a reasonable charge, tune and align either of the above units.

• **STERN'S "fidelity" PREAMPLIFIER-TONE CONTROL UNIT** . . . A design for the "Hi-Fi" enthusiast! Briefly, it has inputs for MICROPHONES, HIGH and LOW GAIN PICK-UPS, and a RADIO TUNING UNIT. It incorporates (a) GRAM EQUALISING CONTROL, (b) STEEP CUT FILTER, (c) Continuously variable BASS and TREBLE CONTROLS and a VARIABLE OUTPUT CONTROL which enables its use with any make or type of Amplifier. THE COMPLETE KIT OF PARTS is available now for **£6.6.0.**

• **STERN'S "fidelity" 10-WATT AMPLIFIER** . . . This design comprises the MAIN AMPLIFIER of the famous MULLARD 5-10 design and our own "fidelity" PREAMPLIFIER-TONE CONTROL UNIT which we describe briefly above. We incorporate the latest GILSEN ULTRALINEAR OUTPUT TRANSFORMER and the combination of these two units undoubtedly provides reproduction of extremely high quality. In fact, the complete Amplifier is comparable to the very expensive commercially made High Fidelity models. We offer the COMPLETE KIT OF PARTS FOR **£18.16.0.**

• **STERN'S HIGH QUALITY 8-10 WATT AMPLIFIER** . . . This is illustrated and briefly described here. It is one of the most successful Amplifiers (in the lower price range) yet offered to the Home Constructor. We can supply the complete Kit ex-stock for **£7.10.0.** plus 5/- carr. & ins.

• **STERN'S "JUNIOR" PREAMPLIFIER-TONE CONTROL UNIT** . . . Provides full control of BASS and TREBLE in conjunction with main VOLUME CONTROL and can be used with any Amplifier. The unit contains its own POWER SUPPLY . . . THE COMPLETE KIT OF PARTS is available at **£3.16.9.**

• **STERN'S "PERSONAL SET" BATTERY ELIMINATORS** . . . Complete Kits OF PARTS to build Midget "All-dry" Battery Eliminators (a) Providing approx. 69 Volts at 10 m/a and 1.4 Volts at 250 m/a. Price **£2.8.** (b) Providing approx. 90 Volts at 10 m/a and 1.4 Volts at 250 m/a. Price **4/6.**

ALL COMPONENTS TO BUILD THESE AMPLIFIERS, TUNERS, ETC., ARE AVAILABLE FOR SALE SEPARATELY. CONSTRUCTORS CAN, THEREFORE, GRADUALLY BUILD ANY UNIT.



I.C.S. training supplies the spark you need to further your career. The Courses I.C.S. offer are practical and up-to-date, they recognise the present emphasis on Frequency Modulation, and can help you attain one of the many well-paid posts that exist today in the radio world. Prepare yourself now, at home and in your own time, with the expert help of I.C.S. tutors. The cost of an I.C.S. Course is moderate and includes all books.

Among the I.C.S. Courses available are:

- FREQUENCY MODULATION ENGINEERING
- T/V ENGINEERING
- RADIO SERVICING
- RADIO ENGINEERING
- RADAR ENGINEERING
- BASIC ELECTRONICS
- INDUSTRIAL ELECTRONICS
- ELECTRONIC ENGINEERING

Complete the coupon below and post it to us today for further details of the Course which interests you. Write to: Dept. 170E, I.C.S., 71 Kingsway, W.C.2

REDUCED TERMS FOR H.M. FORCES

INTERNATIONAL CORRESPONDENCE SCHOOLS

DEPT. 170E, INTERNATIONAL BUILDINGS KINGSWAY, LONDON, W.C.2.

Please send FREE book on

NAME..... AGE.....

(Block letters please)

ADDRESS

OCCUPATION

**INTERNATIONAL
CORRESPONDENCE SCHOOLS**

TV TUBES 17-16-15-14-12 inch
6 MONTHS' GUARANTEE

17" RECTANGULAR £7/10/0. 14" RECTANGULAR £5 10/0. LOOK—16"—15"—14"—12" ROUND. £5. ALL PERFECT. BARGAIN CLEARANCE. Ideal for test or spares. 22 18—22 17—22 14C. 16 6 only. Slight burns. Post FREE. 12 Cossor—E.M.I.—Mazda. Burns. 12/6. Ins. Carr. 15/6. —75 different tubes listed.

12" TV TUBE CHASSIS, 97 6

Complete television chassis by famous mnr. R.F. E.H.T. unit included. Easily fitted to table or console model. Owing to this chassis being in 3 separate units (power, vision tube) inter-connected.

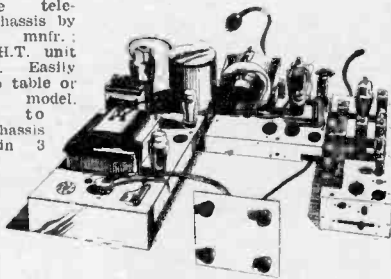

Channels 1-5. Drawing 2/6 or free with order. Our £5 tube fits this chassis. Lists by request. Less valves and tube. Carr. 5/- London, 10/- Provinces.

TV CHASSIS UNITS

TIME BASE, 10 6. Containing scanning coil, focus unit, line trans., etc. FREE drawing, Carr. 3/6.

SOUND & VISION STRIP, 27 6. Sheet, complete s/vision strip, 10 valve holders (EF91, etc.). Less valves. FREE drawing. Post 2/6.

REMEMBER SATURDAY OPEN ALL DAY.

MONEY BACK GUARANTEE **DUKE & Co** Tel: GRA 6677 CWO or COD
621 ROMFORD RD. LONDON, E.12.

THE HAM'S SHOP

Cheapest Television and Electrical Shop in Great Britain. 45, WINTAVERN ST., BELFAST, NORTHERN IRELAND. Phone: 31849.

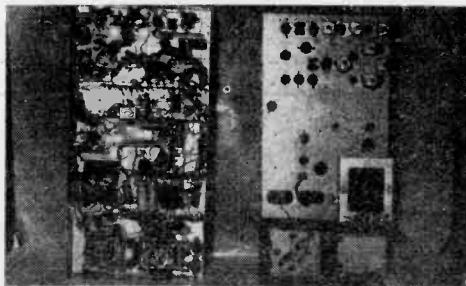

HORN UNITS.—New. £2.10.0 ea. (Special Bargain unrepeatable.) (Deliveries within 14 days—Always at your service.) Please enclose S.A.E. with enquiries.

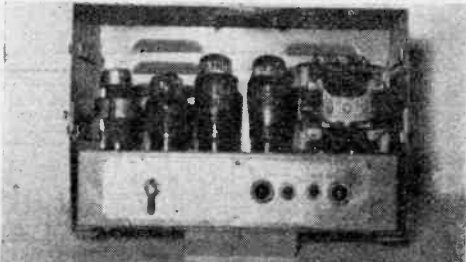

TELEVISION CHASSIS (NEW). £2.10.0 ea., plus carr. and pk., 7 6. **AMPLIFIERS.**—15 w. 12 v. BDT. Suitable for P.A., Sports Meetings, etc., etc., £4.10.0 ea., plus carr. and pack., 15/-.

Servicing Radio Receivers

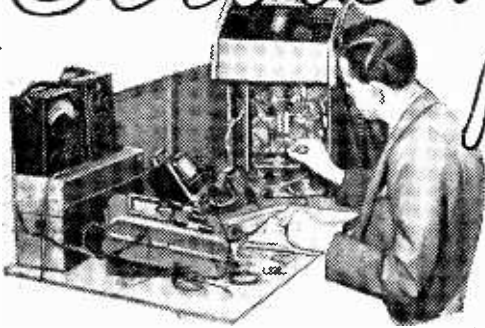

THE ULTRA TROUBADOUR

By Gordon J. King, A.M.I.P.R.E.

THIS is an attractive A.C./D.C. transportable receiver designed into a moulded two-colour plastic cabinet with carrying handle. It features two wavebands, five valves, including H.T. rectifier, in a superhet circuit, and an internal frame aerial.

The full circuit diagram of the receiver is shown at Fig. 1. Here it may be seen that the signals developed in the M.W. frame aerial L3 are conveyed to the signal grid of the heptode section of the frequency changer valve V1 through switch S1A. On L.W. frame aerial L1, with the L.W. loading coil L2, is connected in series with L3, and also the L.W. trimmer is brought into circuit by reason of S1B. Switch S1C also functions to short-circuit the L.W. loading coil L2 on M.W. The aerial circuit is tuned by the C1 section of the two-gang tuning capacitor. The oscillator circuit features only one coil for both wavebands. On L.W. the oscillator frequency is suitable reduced by the L.W. oscillator trimmer T3 and associated shunt capacitor which are brought into circuit by switch S1C. The magnitude of oscillation is approximately equalised over both wavebands by the switching in of the 1.8 k. resistor (connected to the top of L4) on M.W. only. Trimmer T4 and associated shunt capacitor constitutes the oscillator paddler, while trimmer T2, connected across C2 section of the two-gang tuning capacitor, functions to trim the oscillator on M.W.

The oscillator is adjusted to produce an intermediate frequency (I.F.) of 465 kc/s; this signal, being developed in the first I.F. transformer (I.F.T.1), is passed on to the signal grid of the I.F. amplifier valve V2. It is thus further amplified and re-developed in the second I.F. transformer (I.F.T.2).

From here it is taken to the signal diode in V3 where it is demodulated. The A.F. content of the signal thus appears across the volume control. The network comprising R1, C5 and C6 acts as an I.F. filter and prevents I.F. signals gaining admittance to the A.F. stages of the receiver.

A.V.C.

The rectified I.F. signal appearing at the junction of R1 C5 produces a potential negative with respect to chassis whose magnitude follows the amplitude of the I.F. carrier. Therefore, the stronger the signal the greater will be the negative potential at junction

R1 C5. This potential is used as A.V.C. bias for valves V1 and V2, being conveyed through the 1M filter resistor R2, through R3 to V1, and through the secondary of I.F.T.1. to V2. It will be observed that the second diode in V3 (generally used as an A.V.C. diode) is connected direct to chassis in this receiver.

It will also be noticed that no standing bias is given to valves V1 and V2, so that a prolonged defect in the A.V.C. system, apart from introducing distortion on strong signals, would also be liable to harm the first two valves.

The A.F. Stages

The A.F. signal appearing across the volume control is taken by way of the coupling capacitor C8 to the grid of V3. The triode section in the valve operates as a voltage amplifier at A.F., and the amplified A.F. signal appears across the 100 K resistor R4 in the anode circuit.

Progressive deterioration in the quality of reproduction from these receivers is sometimes caused by R4 increasing in value. This component has been known to rise to something like 500 K and, although the receiver still functions reasonably well at low volume, a disconcerting distortion is evidenced on sibilants and loud transients, and is clearly noticeable towards the limits of maximum volume.

This fault is not always easily revealed by making a voltage reading, relative to chassis, at the anode of the valve, as R4 itself even when of normal value represents a fairly high resistance in series with the test meter. As will be seen on the circuit diagram, 32 volts only are registered when a 1,000 ohms per volt meter is employed. It is desirable to disconnect

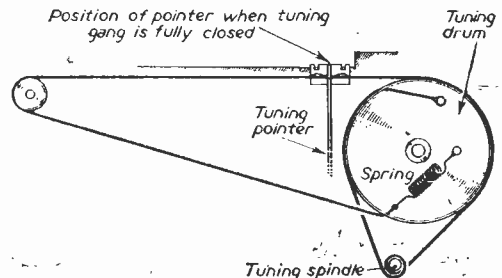

Fig. 4.—Tuning drive cord details.

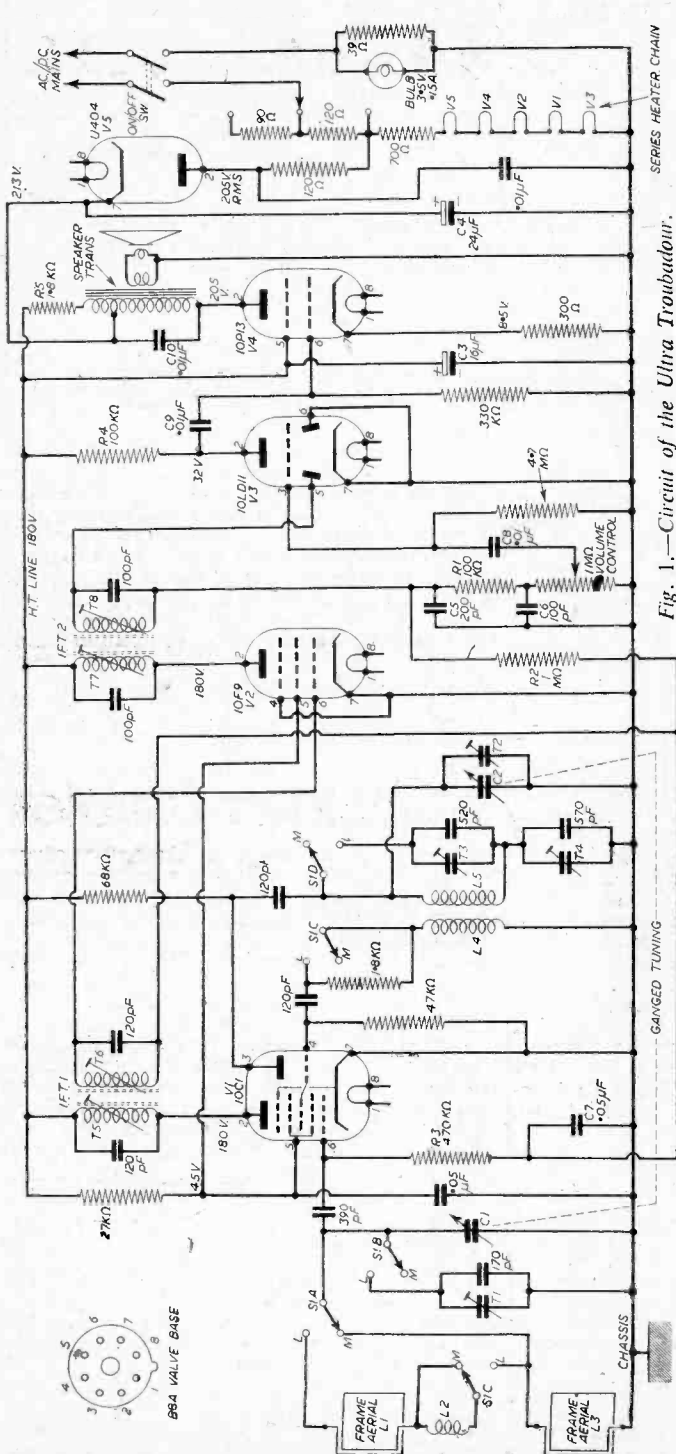

Fig. 1.—Circuit of the Ultra Troubadour.

one side of the resistor and measure its value, or, alternatively, substitute it for one of known value.

The A.F. signal is transferred to the signal grid of the output valve V4, via the second coupling capacitor C9. This capacitor is another source of trouble which, particularly in early models in this series, tends to become slightly leaky and consequently transfer a positive potential, relative to chassis, on the grid of V4. This has the effect of outweighing the standing bias on this valve, causing its operational characteristics to be severely disturbed. Again, the symptom is distortion, though of a different kind from that previously considered. In this case impaired quality is evidenced at all volume settings, the output valve runs extremely hot as the result of excessive current, and the voltage at the cathode rises higher than the stipulated 8.5 volts.

Standing bias is given to V4 by reason of the 300 ohm resistor in the cathode circuit, and since this resistor is not by-passed the stage is subjected to a degree of current feedback, which also causes an increase in the output stage impedance. The anode circuit is loaded by a tapped primary output transformer and loudspeaker. H.T. is fed to the anode via the primary tap, and as the result of this the hum voltage in the secondary winding is reduced due to neutralisation of the hum voltages in either section of the primary winding. It is important, therefore, to employ a correct type transformer when replacement is necessary.

Fixed tone control is given by the 0.01 μF capacitor C10 in the anode circuit. A good quality component is required for this position, and replacement is best made with one having a working rating of 1,000 volts.

The loudspeaker used in this receiver has been known to become defective as the temperature of the inside of the cabinet rises. This is due to distortion of the cone and speech coil which causes fouling of the coil on the magnet pole piece. Unfortunately, the speaker cannot usually be adjusted to cure the fault, and replacement is nearly always necessary.

(Continued on page 345)

SOUTHERN RADIO'S WIRELESS BARGAINS

TRANSRECEIVERS. Type "38" (Walkie-Talkie). Complete with 5 Valves. In Metal Carrying Case. Ready for use. Less external attachments, 30/- per set. ATTACHMENTS for use with "38" TRANSRECEIVER: HEADPHONES, 15/6; THROAT MICROPHONE with Lead & Plug, 4/6; JUNCTION BOX, 2/6; AERIAL 2/6.

TRANSRECEIVERS. Type "18" Mark III. TWO UNITS (Receiver & Sender) contained in Metal Case. Complete with Six Valves, Microammeter, etc. LESS EXTERNAL ATTACHMENTS, £4/10/-.

TRANSMITTERS.—T.1154—Complete all valves, etc., etc. Perfect order. 3 frequencies. £2/7/6 in transit case. Delivered U.K.

RECEIVERS. Type "109." 8-Valve S.W. Receiver with VIBRATOR PACK for 6 Volts. Built-in Speaker, METAL CASE, £5.

BOMBSIGHT COMPUTERS. Ex-R.A.F. BRAND NEW. A Wealth of Components. GYRO MOTORS, REV. COUNTERS, GEAR WHEELS, etc., etc. Ideal for Model Makers, Experimenters, etc., £3.

LUBBRA HOLE CUTTERS. Adjustable $\frac{1}{2}$ in. to $3\frac{1}{2}$ in. For Metal, Wood, Plastic, etc., 7/-.

RESISTANCES. 100 ASSORTED USEFUL VALUES. Wire Ended, 12/6 per 100.

CONDENSERS. 100 ASSORTED. Mica, Metal Tubular, etc., 15/- per 100.

PLASTIC CASES. 14in. x 10 $\frac{1}{2}$ in. Transparent. Ideal for Maps, Display, etc., 5/6.

STAR IDENTIFIERS. Type I A-N. Covers both Hemispheres, in Case, 5/6.

CONTACTOR TIME SWITCHES. In Sound-proof Case, Clockwork Movement. 2 Impulses per sec. Thermostatic Control, 11/6.

REMOTE CONTACTORS for use with above, 7/6.

MORSE PRACTICE SET with Buzzer on Base, 6/9. Complete with Battery, 9/6. **MORSE TAPPERS**, Std. 3/6; Midget, 2/9.

METERS & AIRCRAFT INSTRUMENTS. Only need Adjustment or with broken Cases. TWELVE INSTRUMENTS, including 3 brand new Aircraft Instruments, 35/- for 12.

CRYSTAL MONITORS. Type 2. New in Transit Case. Less Valves, 8/-.

Postage or Carriage extra. Full List of RADIO BOOKS, 2/6.

SOUTHERN RADIO SUPPLY LTD.,
11, LITTLE NEWPORT ST., LONDON, W.C.2. GERrard 6653

JASON FOR F.M.

An easy-to-build Tuner using four valves Type Z77/EF91. Providing leads are kept short and soldered joints are well made, good results are guaranteed. The useful range is at least 60 miles from the station. The Book also gives details of a Fringe Area version which has an aerial sensitivity of 5 micro-volts for good limiting. Book (Data Publications), price 2/- . All components (less valves), **£5.5.0.**

For the more experienced, the Medium Wave and F.M. Tuner is available. This may be built either as a tuner or receiver. The Assembly is supplied with the centre holes blocked by easily removable plastic discs. F.M. sensitivity is 15 micro-volts. Components (less valves) to build Receiver, **£11.10.0.** Tuner, **£10.10.0.**

Available from our usual stockists.

S.A.E., please, for Component Price Lists.

THE JASON MOTOR & ELECTRONIC CO.
328, Cricklewood Lane, London, N.W.2. SPE 7050.

A REALLY SELECTIVE 5-VALVE SUPERHET



139/6

Plus 2/8 for Postage & Packing

Our "know-how" shows you the easy way to surprise friends with this Superhet.

No Radio knowledge necessary. Easy to read step-by-step instructions and Diagrams. We guarantee it to work. Only tools needed are Pliers, Screwdriver and Soldering Iron.

IDEAL FOR BEGINNERS . . .

Let us show you how simple a 3 Valve TRF Receiver can be to make our way and how amazed you will be. Easy-to-Follow instructions take the headaches out of construction. Hundreds already working all over the country. 109/6, plus 2/8 post and packing.

A PROFESSIONAL JOB MADE SIMPLE

Nothing to lose—Our MONEY-BACK guarantee covers you. Complete parts available for the above receivers in Cream or Brown cabinets. . . . Write to-day and get started on the fascinating Hobby of Electronics.

EASY INSTRUCTIONS WITH OUR "KNOW-HOW" DIAGRAMS, 1/- POST FREE. SEND TO-DAY.

NORMAN H. FIELD Electronics
Dept. PW, 68, HURST STREET, BIRMINGHAM, 5
Birmingham's Largest Constructors' Store.

THE FAMOUS BENNETT COLLEGE
can train your mind to **SUCCESS**

THROUGH PERSONAL POSTAL TUITION
A FREE book vital to your career!

WHAT CAREER DO YOU WANT?

- Building
- Carpentry
- Commercial Art
- Diesel Engines
- Draughtsmanship
- Electrical Eng.
- Fire Engineering
- Mechanical Eng.
- Quantity Surveying
- Radio Eng.
- Surveying
- Telecommunications
- Television

- Accountancy Exams
- Aviation's Exams
- Book-keeping
- Civil Service
- General Education
- Journalism
- Languages
- Mathematics
- Police Subjects
- Salesmanship
- Secretarial Exams
- Shorthand
- Short Story Writing
- and many others
- GENERAL CERT OF EDUCATION**

Read how the famous Bennett College can help you to success! Send now for this recently published FREE book, "Train your mind to SUCCESS", which tells you about The Bennett College proven success in postal tuition . . . and how it can help you to success in your career.



FREE

To The Bennett College (Dept. G.104N), Sheffield
Please send me, without obligation, a free copy of 'Train your mind to SUCCESS' and the College Prospectus on:

SUBJECT _____
NAME _____
ADDRESS _____
AGE (if under 21) _____ Please write in Block Letters

THIS COUPON
COULD BE YOUR PERSONAL PASSPORT TO SUCCESS.
Send it NOW!

The Power Supply

As this is an A.C./D.C.-type receiver the valve heaters are connected in series in the pattern shown on the circuit. The mains voltage applied to them is dropped to the correct level by the tapped three-section resistor—the tapping being made to suit the local mains voltage. The 3.5 volt 0.15 amp pilot bulb is also connected in series with the heaters, and to avoid frequent failure the bulb is shunted with a 39-ohm resistor.

Mains voltage is applied to the anode of the H.T. rectifier valve V5 through a 120-ohm limiter resistor; the associated 0.01 μ F capacitor (which should be rated at 300 volts A.C.) serves to reduce the possibility of modulated hum. H.T. smoothing is effected by the dual electrolytic capacitor C3/C4 and the 1.8 K resistor R5. It is important to note that the ripple current rating of C4 should be at least 100 mA.

Servicing Notes

The chassis is easily removed from the cabinet by extracting the two control knobs and wavechange control from the front, and removing the two counter-sunk screws from the bottom. It will be noticed that the chassis fixing screws are covered with wax. This is to eliminate the risk of electric shock to the user, bearing in mind, of course, that the chassis on this type set is liable to be "live" to earth. The screws should thus be re-treated with wax when reassembling the receiver.

The engineer should exercise care when actually removing the chassis, for the leads connecting the frame aerial to the receiver are of limited length, and it is easy inadvertently to pull off a lead or break a tag during the operation. For certain service operations it is necessary to enlarge the length of the frame aerial leads, but the originals should be used when realigning.

Fig. 4 shows the tuning drive arrangement, while Figs. 2 and 3, respectively, illustrate the top and underside views of the chassis, indicating the position of the valves and more important components.

Alignment Instructions

Before commencing realignment the tuning pointer should, if found necessary, be adjusted on the drive cord so that it correctly traverses the whole length of the tuning scale, and the mains should be connected to the receiver so that the chassis is at neutral mains potential.

An output meter is connected across the secondary of the speaker transformer, and the output of a modulated signal generator is connected, via 0.1 μ F isolating capacitors, across C1 section of the tuning gang.

Switch the receiver to the low-frequency end of the M.W. band, tune the generator to 465 kc/s and adjust T8 (Fig. 3), T7 (Fig. 2), T6 (Fig. 3) and T5 (Fig. 2), in that

order, for maximum output. Repeat until no further improvement is possible.

Disconnect the signal generator from across C1, and lightly couple to the receiver frame aerials. This can be done by clipping the generator output lead to the insulation on one of the aerial connecting leads. Alternatively, the generator signal can be applied across a coil consisting of 13½ turns of 18 s.w.g. enamelled copper wire wound on a ½ in. diameter former to a length of 1¼ in. When this method is employed, the coil should be placed approximately 6 in. from the frame aerial. On no account should a direct connection exist between the receiver and the generator.

Tune the generator to 1,500 kc/s and the receiver to 200 metres M.W., and adjust T2 (Fig. 2) for maximum output.

Tune the generator to 600 kc/s and the receiver to 500 metres M.W., and adjust T4 (Fig. 2) for maximum output.

Repeat the above two adjustments while "rocking" the tuning gang until no further improvement is possible.

Tune the generator to 220 kc/s and the receiver to 1,362 metres L.W., and adjust T3 and T1 (Fig. 2), in that order, for maximum output.

Repeat for optimum results.

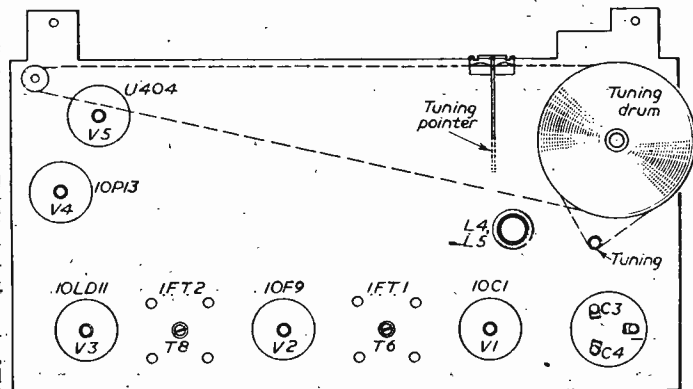
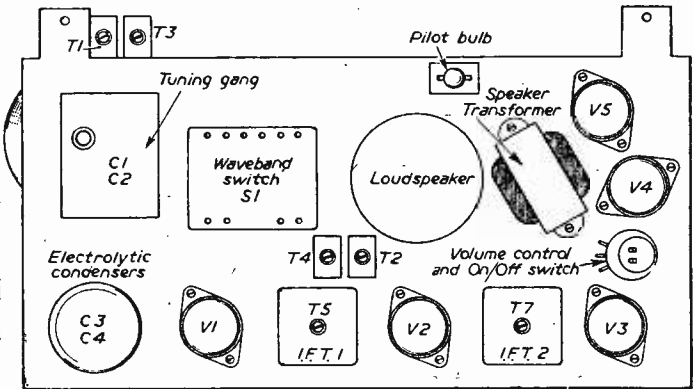

Figs. 2 and 3.—Top and below-chassis layout.

Programme Pointers



THE new series of Sunday evening panel discussions, "Something to Say," got off to a fair start. Under the chairmanship of Robert Henriques, it varies from similar programmes in that each member of the team argues the case for a theme of his own choice, instead of one selected by someone else. It has the advantage of being *in camera*, but will obviously depend on the type and quality of the subjects and arguments brought to the microphone for its health and longevity. They were of uncertain interest in the first two occasions I listened to it. I hope it succeeds.

The Story of Songs

What a mistake it is to "give the story" of songs sung in foreign languages before their performance! Most of the poems which form their basis are third rate, and become tenth rate on translation. "When the sun comes out the flower blooms and I think of thee" is about the level though not the length, of most of it! Who on earth can want that sort of rubbish preceding the divine melodies of Schubert and others?

Talking of poems reminds me of a bit of a gaffe in the title of a recent programme. It was called "Poems by Heart," read by Patrick Dickinson!!!

Roman Britain

This series, the story of the four centuries of Roman occupation, was both enthralling and fascinating. Under the expert and masterful chairmanship of Sir Mortimer Wheeler, President of the Society of Antiquaries, and expounded by a number of the most eminent specialists, the past was unfolded with an unerring instinct for entertainment and erudition. I regret I had to miss a couple of them.

Talks

Another series which appealed to me was the six talks given by well known writers, entitled "I Choose . . .", each one selecting from the immediate past a novelist who, in their opinion, has been unjustly neglected by Dame Fortune. Much new critical appraisal was shed on such authors as Arthur Morrison, C. E. Montague and Norman Douglas.

Plays

The plays, recently, have been exceptionally interesting. Two, in an Agatha Christie festival, were sufficiently entertaining to make one offer the suggestion of a regular weekly "whodunit" feature. I heard "The Mysterious Affair at Styles," "The A.B.C. Murders" and "Murder in Mesopotamia." We had three different interpretations of Hercule Poirot, namely, John Gabriel, Austin Trevor and Jacques Brunius. I preferred Mr. Brunius, whose enforced accent suited the part to perfection. Austin Trevor has much experience as the famous detective. John Gabriel was very effective, too, but he occasionally shed his Flemish disguise to an alarming degree.

Our Critic, Maurice Reeve, Reviews Some Recent Programmes

Oscar Wilde's melodramatic story of the Picture of Dorian Gray, in which the painting on the canvas changes from superficial good looks to stark, hideous reality as the sitter's soul influences it, has been rendered into every imaginable entertainment medium other than its original fictional guise. Constance Cox's play, adapted and produced by Martyn C. Webster, made excellent radio. The characters of Dorian Gray, the artist Basil Hallward, and Dorian's evil mentor Lord Henry Wotton, fill almost the entire canvas. They were splendidly played by David Peel, Denis Goacher and Anthony Jacobs.

Equally good was Cynthia Pughe's adaptation of Val Gielgud's "The Bombshell." This tells of a gifted nuclear scientist who, in being tested for his perfect loyalty, is made to believe he has been sacked from his job and about to be "shanghaied," contains meaty dialogue and dramatic situations. It was put over with great aplomb by Hamilton Dyce, Christine Bocca, Ursula Howells, Richard Williams, Brewster Mason, Richard Johnston and Geoffrey Segal.

The "Radio Times"

It may not be out of place to say, here, how preferable the "Radio Times" format was, during the printing trade dispute, to its usual shape. As a newspaper, with its normal quota of articles and photos, it could comprise as many pages as its publishers saw fit to include. Of its greater convenience as a programme guide there can surely be no two opinions.

Regional Programmes

A shortened version of the original North Regional programme, "Parks for the Nation," served as a useful reminder of our debt to these lovely places, and of our obligations towards preserving their beauties and amenities.

"The Sailor's Return"—the name of a "pub," by the way—was a bright and breezy contribution from West Regional. Based on David Garnett's novel by Aileen Mills, it told of a West Country skipper's adventures, and misadventures, on arriving home with a lady of coloured charms, and of his investment in "The Sailor's Return" house of rest and refreshment. Its briny pungency, was well brought out by, amongst others, Henry Goodall and Nadia Catouse.

"The Peacemakers," Third, was based on the translated notes of Professor Paul Mantoux, French interpreter to the "big four" at the Paris Peace Conference in 1919 and published in 1955. It served to stir the memories of the older and middle-aged.

62AK This Month's Bargains

Don't miss this one!

CRYSTAL HAND MICROPHONES

As illustrated, in silver hammer case with polished grille, handle and 4 feet screened lead. ONLY 21/-.



ABSORPTION WAVEMETERS

3.00 to 35.00 Mc/s in 3 switched bands. 3.5, 7, 14, 21 and 28 Mc/s Ham bands marked on scale. Complete with indicator bulb. A MUST for any Ham Shack. ONLY 15/- each, p. & p. 1/-.

BUG KEYS by famous maker. Streamlined case. Brand New in original cartons. List over £4; CUR PRICE, 45/-, post frge.

HEAVY DUTY 25 w. Toroidal Pots by FOX, 700 ohms 3/6 ea., p. & p. 1/6.

CONDENSERS. 8µF 600 v. Trop. 750 v. normal condensers. NEW, ex W.D. stock, 5/6, p. & p. 1/6.

New TCC Type III. 8 mfd. 1,000 v. D.C. wk'g. (List over £3). OUR PRICE 10/6, p. & p. 1/9

THIS MONTH'S SPECIAL: For the new mobile, 12 V miniature rotary transformers. Output 360/310V, 30 mA c.c.s. or 70 mA i.c.a.s. Only 4½ in. x 2½ in. overall. Only 17/6 each or 30/- for 2. Post and packing 1/6.

No C.O.D. on orders under £1.

PLEASE PRINT YOUR NAME AND ADDRESS.

CHAS. H. YOUNG LTD.

All callers
110, Dale End,
Birmingham 4 (CEN 1635)

Mail Orders to Dept. "P"
102, Holloway Head,
Birmingham 1 (MID 3254)

RADIO CHASSIS

39/6

3 w band & gram. Extra speaker sockets, 5 valves international octal. Built-in portable aerial, optional, 4-knob control. A.C. or universal. Less valves (see our cheap list). 6" P.M. speaker 7/9 with order. Set of knobs 2-. Chassis 15½" x 7" x 5" (when speaker is fitted). Carr. 3/6.

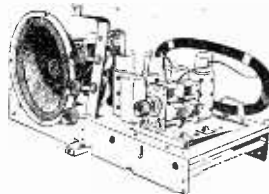

MIDGET RADIO 79 6. Superhet 5 valve A.C. In polished Walnut cabinet. Octal valves. Cabinet measures 13½" x 9" x 7½". Ideal for kitchen or bedroom. Tested working. Ins. Carr. 4/6.

RADIO-GRAM CHASSIS 25 9. Complete with 6" speaker. Superhet 5 valve A.C. 3 w band. Invt drive. Complete less valves. Tested guaranteed. Chassis size 12" x 8" x 10". Carr. 4/6.

COIL PACKS 3 9 (3 band) Incl. Pr.: 465 I.F.s., 2 gang cond. & dial (similar drawing free). 1 cst 2/3.

SPEAKERS 8 2. Std. 6" P.M. as new, guaranteed. With matching O.P. trans. 10 9. Post 2/3.

EXTENSION CABINET SPEAKER 18 6. 6" P.M. Speaker in polished walnut cabinet. Ideal for kitchen or dining-room. Post 3/6.

TRANSFORMER SALE

Mains Trans. 5 9. 350-0-350v. 10 m.a. Htrs. Cv. & 5v. Prim. 200-250v. Mains Trans. 3 9. 350-0-350v. 10 m.a. Htrs. 4v. & 4v. Prim. 200-250v. Post on each mains trans. 2/3. Power Trans. 15 9. 225-0-225 v. 250 m.a. 6 v. at 5 amp., 4v. at 5 amp., 4v. centre tapped. Post 2 9. Power Trans. 15 2. 350-0-350v. 250 m.a., Cv. at 5 amp., Cv. at 5 amp., 2v. at 1 amp. Post 2 9.

REMEMBER SATURDAY OPEN ALL DAY

MONEY BACK GUARANTEE **DUKE 660** Tele: GRA 6677 CWO COD
621 ROMFORD RD. LONDON, E.12.

"You can rely on us"

LARGE STOCKISTS OF RADIO AND ELECTRONIC COMPONENTS

H.P. on INSTRUMENTS, "912" and MULLARD AMPLIFIER KITS, SOUND-MASTER, VIEWMASTER, Etc., Etc.

RESISTORS — STANDARD, MIDGET, HIGH STABILITY, PRECISION; TAPPED VOL. CONTROLS, Etc., Etc.

SEND FOR LIST.

Proprietary catalogues available to Manufacturers' Laboratories, Education Authorities, etc.

RADIO SERVICING CO.,

82, SOUTH EALING ROAD, LONDON, W.5.

EAL 5737

FREE TO AMBITIOUS ENGINEERS!

This 144-page Book



'ENGINEERING OPPORTUNITIES' is a highly informative guide to the best-paid Engineering posts. It tells you how you can quickly prepare at home on "NO PASS—NO FEE" terms for a recognised engineering qualification, outlines the widest range of modern Home-Study Courses in all branches of Engineering and explains the benefits of our Employment Dept. If you're earning less than £15 a week you cannot afford to miss reading this unique book. Send for your copy to-day—FREE.

..... FREE COUPON
Please send me your FREE 144-page "ENGINEERING OPPORTUNITIES"

NAME
ADDRESS
.....
Subject or Exam. that interests me
British Institute of Engineering Technology
409B, College house, 28-31, Wright's Lane, Kensington, W.8.

Have you sent for your copy?

WHICH IS YOUR PET SUBJECT?

- Mechanical Eng.
 - Electrical Eng.
 - Civil Engineering
 - Radio Engineering
 - Automobile Eng.
 - Aeronautical Eng.
 - Production Eng.
 - Building, Plastics, Draughtsmanship
 - Television, etc.
- GET SOME LETTERS AFTER YOUR NAME!**
- A.M.I.Mech.E.
 - A.M.I.C.E.
 - A.M.I.P.E.
 - A.M.M.I.
 - L.I.O.B.
 - A.F.R.Ae.S.
 - B.Sc.
 - A.M.Brit.I.R.E.
 - CITY & GUILDS
 - GEN. CERT. OF EDUCATION
 - etc., etc.

BIET

G.W. SMITH & CO
(RADIO) LIMITED
3-34 LISLE STREET, LONDON, W.C.2
TELEPHONE: GERRARD 8204/9155

BENDIX COMMAND RECEIVERS
Still available complete with all valves and in good condition.

BC. 454. 3-6 mc/s	27/6
BC. 455. 6-9.1 mc/s	25/-
BC. 453. "Q-FIVER" 190/550 kc/s	59/6
TOP BAND MODEL. 1.5-3 mc/s	65/-

METER BARGAINS

500 microamp. 2 1/2 in. F.M.M.C.	59/6
500 microamp. 2 in. F.M.M.C.	16/6
50 m/amp. 2 in. F.M.M.C.	7/6
200 m/amp. 2 1/2 in. F.M.M.C.	9/6
1 amp. R.F. 2 1/2 in. F.M.T.C.	6/9
1 amp. R.F. 2 1/2 in. Pj. T.C.	5/-
4 amp. R.F. 2 in. F.M.T.C.	5/-
300 volt D.C. 2 in. M.C.F.M.	10/6
300 volt A.C. 2 1/2 in. F.M.M.I.	25/-
500/0/500 microamp. 2 1/2 in. F.M.M.C.	25/-

MULLARD RESISTANCE/CAPACITY BRIDGES. Type GM.4140/1. Special offer of these test instruments in perfect working order. Operation on 110/230 volt A.C. Tuning by magic eye. Ranges: 10 pF-10 mfd, 1 ohm-10 megohm. Only a few available, price £5/19/6 each.

CRYSTAL MICROPHONE INSERTS, 4/6 each.

COLLINS MOD. TRANSFORMERS. Brand new, push-pull 807 to 807, 12/6 each.

JACK PLUG LEAD, 6ft. screened lead with two standard jack-plugs, 3/- each.

FIELD TELEPHONES. Type DON. Mk. 5. Ideal for inter office, house, playing field communication. Supplied complete with handset, buzzer, bell, etc. Supplied with two 1.5 v. cells to operate. Price 39/6 each.

TRANSFORMER SNIP. Input 230 volt 50 cycle. Output 10 volt C.T. 5 amp. 10 volt C.T. 5 amp., and 10 volt C.T. 5 amp. Price 29/6 each.

GRAM MOTOR OFFER. Garrard 200/250 volt motors and turntable, variable speed 0.45 r.p.m. Ideal for L.P. records, 22/6 each.

A.R.83 RECEIVER SPARES. Brand new Ceramic switch assemblies in original cartons, 17/6. Brand new drive assemblies in original cartons, 10/6.

DEAF AIDS. Complete chassis with three sub-miniature valves, volume and tone controls, crystal mike, etc., less only outside bakelite case, 19/6 each. 30 ohm earpieces to match, 3/6 each. Leads 1/-. Batteries, 2/9 pr. Spare valves CK 505 2/6. Spare pots. 1 meg w/switch, 1/-.

MINIATURE H.T. TRANSFORMER. 220/240 volt input. Output 200 volt 25 mA. and 6.3 volt 1 amp., 10/6 each. Midget metal rectifier to match, 7/6.

CHOKO BARGAINS. G.B. type, 20 H. 175 mA., new, 10/6. Parmeko swinging choke 3.2/4.8 H. 250 mA., new, 10/6. Collins potted type 8 H. 100 mA., new, 8/6. 15 H. 60 mA., 5/6. 10 H. 40 mA., 3/6.

HOURS OF BUSINESS: 9 a.m.—6 p.m., Thursday, 1 p.m. Open all day Saturday. Please print name and address clearly and include postage or carriage on all items.

ALFRED PADGETT
40, MEADOW LANE, LEEDS 11
Tel.: Cleckheaton 99

New TX 1154 Model H. In maker's cases. Four-wave Band. The best of all 1154 sets. All all chassis. 37 6. Carriage 12 8 (complete with all valves).

New TX 1154 Model N. In maker's cases. Three-wave Model. Complete with all valves. 25 -. Carriage 12 6.

Bring your T.V. set up to date with the ZC13312 R.D.F. No. 1 set. These sets are Brand New in maker's metal case. R.P. osc. and mixer stages. Suitable for I.T.A. 4 I.F. stages and they are tunable. Valve line up: 13 in. all—5 VR65, 1 CV63, 1 VR137, 2 VR66, 1 VR54, 3 VR92, less power rack, but otherwise complete. This is offered at the very low price of 15 - only, with 13 valves. Less valves. 8.6. Carriage and packing, 7/6.

Condenser Bargain. 8 x 8 x 8 450 volts working and surge proof, neat and compact. 2 6. post 9d. £1.5.0 per doz. lots, post free.

Special purchase of Crystal Diodes, 10d. each. Post 2id. These are the Real McCoy, with long wire ends and will put real pep into any crystal set.

Small 24-Volt A.C. 'D.C. Motor. 1,800 revs. p.m. Good torque on 12 volts. Brand New, 3/6 (scrap price), post 1 9.

Small Ball Races for model maker, etc., 6d. each, post 3d. Doz. lots 5/- post free.

Small Metal Rectifiers, 12 months' guaranteed. 250 volts at 100 mills. 6 6, post 1 3.

Brand New 3BP1, complete with base and screening case. Just the job for a scope or beside T.V. 15 -. insurance and packing 4 -.

Radio Valves with a 90 days' guarantee, post 9d. per valve. Doz. lots post free less 5 per cent.

8D2, 1/-; VR56, 4/-; 6K79, 4/-; 6HG6, 1 3; 6H6M, 1 9; 6G6, 3 6; 6SN7, 8 6; 6X5, 5 -; 6X2, 1 6; VU11, 1 6; 954, 1 3; CV6, 1 -; VR137, 1 3; VR85, 1 8; VR66, 1 -; VR54, 9d.; CV63, 1/-; VR92, 9d.

Handy Box of Mixed H.A. Nuts and Bolts, 1lb. weight, 1/-, post 9d.

FIRST-CLASS RADIO COURSES . . .
GET A CERTIFICATE!
QUALIFY AT HOME—IN SPARE TIME

After brief, intensely interesting study—undertaken at home in your spare time—YOU can secure your professional qualification. Prepare for YOUR share in the post-war boom in Radio. Let us show you how!

FREE GUIDE
The New Free Guide contains 132 pages of information of the greatest importance to those seeking such success-compelling qualifications as A.M.Brit.I.R.E., City and Guilds Final Radio, P.M.C. Radio Amateurs, Exams., Gen. Cert. of Educ., London B.Sc. (Eng.), A.M.I.P.E., A.M.I.Mech.E., Draughtsmanship (all branches), etc., together with particulars of our remarkable Guarantee of **SUCCESS OR NO FEE**. Write now for your copy of this invaluable publication. It may well prove to be the turning point in your career.

FOUNDED 1885—OVER 150,000 SUCCESSES
NATIONAL INSTITUTE OF ENGINEERING
(Dept. 461), 148, HOLBORN, LONDON, E.C.1.

WHAT is a "COMMUNICATIONS" RECEIVER?

This description is often loosely applied to various forms of short-wave sets, and the "Communications" Receiver is certainly primarily concerned with short waves. BUT truly to merit the title, the "Communications" Receiver must be a good deal more than just a short-waver. ITS specifications must cover

- High Sensitivity—
- Selectivity—
- Accurate Dial Calibration
- Easy, Effortless Tuning—
- Morse or Telephony—
- Plus Utmost Reliability and Consistency of Reception.

THE EDDYSTONE "810A"

IS A TRUE "Communications" Receiver designed and built to fulfil the exacting requirements of the professional and the discerning amateur who must have

CONSISTENT WORLD-WIDE RECEPTION

THE "EDDYSTONE" "840A" COSTS £55.0.0, and is available from stock at WEBB'S RADIO

Fully detailed brochure post free on request.



14 SOHO ST., OXFORD ST., LONDON, W.1
Telephone: GERRARD 2089.

Shop Hours: Mon., Tues., Wed. and Fri. 9 a.m.—5.30 p.m. Thursday, 9 a.m. to 7 p.m. Saturday, 9 a.m. to 1 p.m.

Surplus Power Valves

DETAILS OF SOME OF THE EX-GOVERNMENT VALVES NOW AVAILABLE

By E. G. Bulley

THESE valves fall into the transmitting category and are perhaps well known to most amateur transmitters. They are, however, not only designed for use in the larger public address amplifiers but are most suitable as R.F. oscillators and modulators.

Their design is somewhat different from receiving valves, as they are much larger physically, are directly heated, and having a thoriated tungsten filament can be fed either from an A.C. or D.C. source.

However, if the filament is supplied from an A.C. supply, the anode and grid return leads should be taken to the centre of secondary winding of the filament transformer. On the other hand, if the filament is fed from a D.C. source, the return lead should be taken to the negative terminal. It is, however, advisable when operating such valves in equipment, to connect permanently a suitable voltmeter across the filament supply; this is necessary to keep a constant watch on the filament voltage.

The reason for this is that as the filaments are of thoriated tungsten, the voltage must not vary more than plus or minus 5 per cent. of its rated value. Failure to take this precaution will result in loss of emission. This loss of emission can also result by the overloading of such valves when in operation. Care must therefore be taken to ensure that the valves are operated within their specified ratings.

Anode Dissipation

An extremely important rating which has a great bearing on this point, is that of the anode dissipation. This is the power measured in watts, and is the power

expended in the anode and dissipated as heat. One will, therefore, appreciate that as these valves have an anode dissipation of a rating much higher than that ever encountered with receiving valves, the material from which such anodes are made must have a high melting point. Such materials as molybdenum, tantalum, zirconium and graphite are used. The latter is perhaps the most common in the small power valves, the reason being that it is much cheaper than those previously mentioned.

Anodes are so designed as to allow the heat to be safely dissipated and this naturally ensures a valve with good life.

Many points have to be considered, therefore, when anode materials are being selected, the foremost being the thermal emissivity, mechanical strength and melting point, and last, but not least, the vapour pressure.

The latter is of the utmost importance because the pressure must be low enough to avoid unnecessary deposits on the bulb and valve structure during the actual operation of the valve and, furthermore, the ability of the material to be easily degassed.

The valves available upon the surplus market have graphite anodes and operate visibly at much lower temperatures than those of the metal anode valves of the same anode dissipation. Graphite anodes have fairly heavy walls to ensure good mechanical strength.

As much heat has to be dissipated from the anode, the reader will find that the bulbs in most cases are made from hard glass. This has excellent mechanical strength and the valves can withstand high temperatures.

One will, therefore, appreciate that adequate

Type	Fil. volts	Fil. current (Amps.)	Anode voltage	μ	Wa (Watts)	Max. Freq. (M/cs)	gM	Base	Power output (2 valves) Watts
CV625	10	3.25	1.5 kV	—	125	30	—	4-pin Jumbo	300
CV628	6.3	4.0	1.5 kV	29	50	60	—	4-pin UX	175
CV735	10	3.25	1.25 kV	5.3	100	—	2.8	4-pin Jumbo	—
CV626	7.5	4.0	1.5 kV	47	50	130	—	4-pin UX	—
CV627	10	4.5	2.5 kV	36	125	30	—	4-pin Jumbo	590
NT39	10	1.65	1.5 kV	22	75	—	5.0	—	—
NT36	6	2.65	1.25 kV	5.5	100	—	4.0	4-pin Special	—
VT143	10	3.25	1.5 kV	—	125	30	—	4-pin Jumbo	300
805	10	3.25	1.5 kV	—	125	30	—	—	300
242C	10	3.25	1.25 kV	12.5	100	6	3.6	—	200
211	10	3.25	1.25 kV	12.0	100	15	3.6	—	200
VT4C	10	3.25	1.25 kV	12.0	100	15	3.6	—	200
812	6.3	4.0	1.25 kV	29	50	60	—	4-pin UX	175
VT217	6.3	4.0	1.25 kV	29	50	60	—	—	175
845	10	3.25	1.25 kV	5.3	100	—	2.8	4-pin Jumbo	—
VT43	10	3.25	1.25 kV	5.3	100	—	2.8	—	—
803	7.5	4.0	1.5 kV	47	50	130	—	4-pin UX	—
810	10	4.5	2.5 kV	36	125	30	—	4-pin Jumbo	590
AT75	10	1.65	1.5 kV	22	75	—	5.0	—	—
830B	10	2	1.0 kV	25	60	15	—	4-pin UX	175

ventilation must be provided when using these valves, and all thoriated filament valves must be operated in a vertical plane only.

Many of these valves utilise the standard four-pin jumbo base, and sockets for them are also obtainable from various surplus dealers and at very reasonable prices.

Table one is a tabulated list of valves available and

should prove useful to the transmitting amateur as well as those readers wishing to construct power amplifiers for public address systems. These valves can be used in the output stages and can be connected in the conventional push-pull arrangement to provide an audio output of much larger magnitude than that obtained from power valves in the receiving valve range.

News from the Clubs

ROMFORD AND DISTRICT AMATEUR RADIO SOCIETY

Hon. Sec. : N. Miller, 55, Kingston Road, Romford.
 AT the A.G.M. held recently, F. Simmons (G2FWJ) was re-elected Chairman, and N. Miller and E. Boxer (G3AUG), Secretary and Treasurer respectively, together with a Committee of five members.

Workshop facilities are now available and a new 150-watt all-band transmitter is being installed. The future programme includes film shows, preparation for N.F.D. and construction evenings.

The Society meets every Tuesday evening at 8.15 p.m. at R.A.F.A. House, 18, Carlton Road, Romford, and all visitors and new members will be warmly welcomed.

THE WEST LANCASHIRE RADIO SOCIETY

Hon. Sec. : K. Wright, G3KVE, 6, Wesley St., Waterloo, Liverpool, 22.

AT the recent A.G.M. the following officers were elected : Chairman, T. Searle ; Treasurer, D. Vaughan, G3UA ; Sec. K. Wright, G3KVE ; Committee Members, G. McCracken, G3GST, H. Roberts, G3KKU.

Meetings continue to be held at the clubroom, over Gordon's sweetshop, St. John's Road, Waterloo, every Tuesday at 8 p.m. Visitors and new members will be warmly welcomed.

BRIGHTON AND DISTRICT RADIO CLUB

Hon. Sec. : Mr. J. Trangmar, 33, Lennox Street, Brighton.

AT the Extra-Ordinary General Meeting of the Brighton and District Radio Club, held at club headquarters on 27th March, 1956, Mr. J. Trangmar was elected Hon. Secretary. The other members of the Committee remain as before. The Committee is now as follows : Chairman, Mr. T. J. Huggett, Vice-Chairman, Mr. C. T. Fairchild, G3YY ; Hon. Treasurer, Mr. R. Sowerby ; Fifth Member, Mr. D. Hemsley.

The club meets every Tuesday at The Eagle Inn, Gloucester Road, at 7.30 p.m. New members and visitors are always welcome.

AMATEUR RADIO CLUB OF NOTTINGHAM

Hon. Sec. : J. Rayner.

THE Annual General Meeting was held in the clubroom at the Sherwood Community Centre, Mansfield Road, Nottingham, on 26th March, 1956, at 7.45 p.m.

Thanks were tendered to Committee members for the work done during the past year. Elected for ensuing year were : Chairman, Mr. C. W. Hage ; Hon. Sec. Mr. J. Rayner (G3KTQ) ; and Treasurer, Mr. A. G. Gwynne. Mr. N. Littlewood was elected to the section committee as representative of the Council.

The programme for the year 1956-57 was discussed at length. It is hoped suitable equipment will be acquired in the near future to enable the club (G3EKW) to be "on the air" regularly.

LOTHIANS RADIO SOCIETY

Hon. Sec. and Treasurer : John Good, 24, Mansionhouse Road, Edinburgh, 9.

A SUCCESSFUL Bring and Buy Sale was held on April 5th. On April 19th the club heard the recorded lecture on "Aerials," by G6CJ, from the RSGB tape library.

June 10th—Bus tour. For details apply to Hon. Secretary.

June 14th—President's Report and Annual General Meeting.

Club meetings are held at 25, Charlotte Square, Edinburgh. Prospective members made welcome.

BURY RADIO SOCIETY

Hon. Sec. : T. C. Platt, 64, Ho'combe Ave., Bury, Lancs.

THE above society has recently been re-organised and meetings will now be held on the second Tuesday of the month at the George Hotel, Kay Gardens, Bury, at 8 p.m. All amateurs in the district will be welcome. For further information please contact G3EJF.

CLIFTON AMATEUR RADIO SOCIETY

Hon. Sec. : C. H. Bullivant (G3DIC), 25, St. Fillans Rd., Catford, S.E.6.

CONSEQUENT upon the resignation of Mr. D. Bennett for personal reasons, Mr. W. Martin, G3FVG, has accepted the invitation to serve on the Committee of the Society.

Mr. D. French, G3HSE, together with other club members, represented the Society at the Mobile Rally organised by the Northampton Short Wave Club in April. Many contacts were made during the day with both fixed and mobile stations.

The club station, G3GHN, operates on 160 metres on alternate Friday evenings during Constructional Evenings. The station has recently been rebuilt and a transmitter is being got ready for use on the H.F. bands. G3GHN will be pleased to receive calls from any station.

June Diary :

8th and 22nd—Constructional Evening and Ragchew.

15th—Junk Sale.

17th—2nd DF Contest.

Meetings are held every Friday at 7.30 p.m. at the clubrooms, 225 New Cross Rd., London, S.E.14. Details of membership can be had upon application to the Hon. Secretary.

PORTSMOUTH AND DISTRICT RADIO SOCIETY

Hon. Sec. : L. B. Rooms (G8BU), 51, Locksway Road, Milton, Portsmouth.

AT the A.G.M. the following were elected. President, S. T. G. Weston G6WS ; Life Vice-President, L. Newnham, G6NZ (R.S.G.B. Council Member) ; Secretary, L. B. Rooms, G8BU ; Treasurer, D. W. J. Haylock, G3ADZ, and a supporting committee. Visitors and club members are welcome at the club rooms, British Legion Club, Queens Crescent, Scutsea.

BETHANY SCHOOL RADIO SOCIETY

Hon. Sec. : P. Wallace. Goudhurst School for Boys, Bethany, Goudhurst, Kent.

THE Society meets every Tuesday evening, but because of a confined working space members have to work in groups of three. So far we have a dozen members.

PLYMOUTH RADIO CLUB

Hon. Sec. : Cyril Teale (G3YB), 3, Berrow Park Rd., Peverell, Plymouth.

PLYMOUTH Radio Club have found a club room at Virginia House Settlement in the Barbican, where meetings are held fortnightly on Tuesdays at 7.30 p.m., 12th and 26th June, 10th and 24th July.

It is hoped to get a club station going for S.W.L.s as well as TX men.

COVENTRY AMATEUR RADIO SOCIETY

FORTHCOMING programme (at 9, Queen's Road, Coventry, 7.30 p.m.).

11th June—Lecture—Mr. Dryburgh.

25th June—Open Night.

9th July—Lecture G3HX.

23rd July—Open Night.

SHEFFIELD AMATEUR RADIO CLUB

Hon. Sec. : G. F. Lyon (G3GJF), 125, Rokeby Rd., Sheffield, 5.

THE above club meets at 8 p.m. on the fourth Wednesday of each month at the Dog and Partridge Hotel, Trippet Lane. During April the club visited the BBC transmitter at Moor-side Edge. It is hoped to arrange a visit to Holme Moss in the near future.

THE CRAY VALLEY RADIO CLUB

Hon. Sec. : S. W. Coursey, G3JJC, 49, Dulverton Road, S.E.9.

THIS club recently celebrated its tenth anniversary and following a change in policy, membership is now extended to non-transmitting radio amateurs. All those interested in any aspect of amateur radio are cordially invited to meetings of the club, which are held at 8 p.m. on the fourth Tuesday of each month at Station Hotel, Sidcup, Kent. Details may be obtained from the Hon. Sec.

EAST KENT RADIO SOCIETY

Hon. Sec. : D. Williams, Llandogo, Bridge, Nr. Canterbury.

THE above society now meets every Tuesday, at 7 p.m. at its new headquarters in basement of the Technical College, Longport Street, Canterbury. Members are at work getting benches made, etc. A group has been formed to build a temporary transmitter and hope to get on top band and eighty with C.W. Several members are getting on well with C.W. lessons given by G2BBT. Mr. D. Williams is giving lectures on theory most weeks. Several members are engaged in building or getting ready D.F. sets for coming D.F. season. Society welcomes new members and visitors in the district.

**CONSTRUCTORS build these at
DOWN-TO-EARTH PRICES**

**PERSONAL
PORTABLE
RADIO** **30/-**

This little set was designed to give you a real personal portable radio that you can enjoy anywhere without disturbing others. Use it on camping trips, in bed, in your office, or just anywhere. **Send 2/- for layout, Wiring diagram and Components Price List.**



1v SHORT-WAVE RADIO

- ★ Covers 10-100 metres.
- ★ World-wide reception.
- ★ Low drain valve.
- ★ Picture diagram and instructions for beginners.
- ★ Assembling time 1 hr.

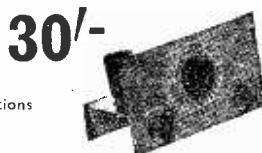

This 1 valve S.W. receiver can be built from our list of components for 30/-, including valve and 1 coil covering 20-40 metres. Provision is made to increase to 2 or 3 valves if required. All components can be purchased separately and are colour-coded so that the beginner can build this set quite easily. **Send 2/- for specification, wiring diagram, layout and price list to :-**

R.C.S. PRODUCTS (RADIO) LTD
11 OLIVER ROAD, LONDON, E.17. Mail order only.

INTRODUCING THE NEW

**PRIMAXA
TWIN SPOTLIGHT
SOLDERING GUN !**

96/6 post free



The New Primaxa Model 100 carries its own spotlight system with two magnifying lenses for uniform and shadow free illumination of the soldering spot. It is a **HEAVY DUTY** solderer, with increased soldering power and is ready for action in 6 seconds. Can be used intermittently without overheating. Available in 110, 200/220, 220/250v. for A.C. only. 50/60 cycles (100 watts).

SHORT TECHNICAL DATA

Power Consumption, 100 watts. Heating Time, 6 secs. Effective Area, 1/64 sq. in. Weight, 34 ozs. Cable length, 6 ft.

ONE YEAR'S GUARANTEE !

(NOT FOR SOLDERING BITS AND BULBS)

Sole Distributors :

S. KEMPNER LTD. 29 PADDINGTON STREET,
LONDON W.1.

Phone : HUNTER 0755

**ALL THESE FINE BARGAINS ARE AT
The Walk-around Shop—**

VIBRATOR PACKS

(Mallory). 12 volt input, 275 volt 80 mA. output. Size 5 1/2 in. W. x 5 1/2 in. H. x 3 in. D. New and Boxed, 25/-, Post & Pkg. 2/6.

R.F. UNITS

R.F.24 20-30 Mc/s, switched tuning, valved, 9/6 ea.; R.F.25 40-50 Mc/s, switched tuning, valved, 9/6 ea.; R.F.26 50-65 Mc/s, variable tuning, valved (New), 25/- ea. Packing and postage 2/- ea.

AR.88

Ceramic wafered Range Switch Assembly. New and Boxed. Price 17/6, Post & Pkg. 2/-.

ADMIRALTY RESPONDER UNIT. W.4799

This receiver tunes from 160-182 Mc/s. Valve line-up VR.136 R.F., VR.92 Mixer, VR.137 Osc., VR.65's in 5 I.F. stages. Modification details available to cover approx 80 to 100 Mc/s. Price 12/6. Each full valved. Post & Pkg. 7/6.

MINIATURE I.F. STRIPS

Size 10 1/2 in. x 10 1/2 in. x 3 in. Frequency 9.72 Mc/s. Line-up : 2 EF.92's and 1 EF.91 I.F. Amp., EB.91 DET/AGC., EF.91 AGC Amp. and EF.91 limiter. Circuit supplied. Price, less valves, 8/- each, post paid.

TYPE "234" POWER UNITS

Double Smoothed 200-250 v. Input. 260 v. 100 mA. 6.3 at 6 amps. with voltmeter reading input and output voltages. Size : 19 in. x 10 in. x 6 1/2 in. Standard Rack Mounting. Price £4.10.0 each, plus 7/6 Post & Pkg.

BENDIX I.F. TRANSFORMERS

1.63 megs. Complete in cans set of 2 New and Boxed. Size 2 in. x 1 1/2 in. x 3 1/2 in. Price 5/- each, Post & Pkg. 1/6.

INSULATING TAPE

Perfect condition, 1/2 in. wide, 25 yds. reels. Foiled in tins. Price 1/3 each. Post & Pkg. 8d.

NOTE : ORDERS AND ENQUIRIES TO DEPT. 'P.'

PROOPS BROS. LTD. Telephone LANgham 0141
52 Tottenham Court Road, London, W.1.
Shop Hours : 9-6 p.m. Thursday : 9-1 p.m. **Open all day Saturdays**

Three hours'

RECORDING & PLAYBACK
with the

EDITOR
TAPE
RECORDERS

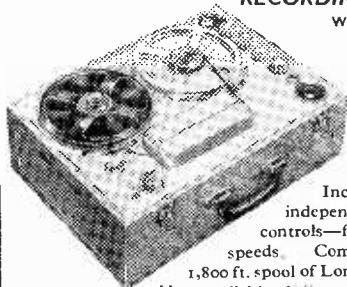

Increased sensitivity — independent Bass and Treble controls—fully automatic—two speeds. Complete with mic. and 1,800 ft. spool of Long Play Tape, **48 gns.** Also available Editor Super Hi-Fi, with additional roin. speaker in lid, **62 gns.**

THE M.O.S. PERSONAL CREDIT PLAN

Used by all discerning and careful buyers, the M.O.S. Personal Credit Plan provides easy repayment terms coupled with low service charges. For example, you can buy the above tape recorder in this way, the deposit being 50%. Please let us know your requirement and we will quote details by return. Send your deposit with your order, allowing sufficient for carriage and packing extra, in order to secure your needs. Please specify over what period (up to a maximum of 18 months) you wish to repay and the necessary forms will be sent to you immediately. **CREDIT SALE TERMS** are also available if you prefer these. Repayment by 9 equal monthly instalments. Send for details.

M.O.S. Personal Credit Plan facilities are available on all equipment sold by us.

E. & G. MAIL ORDER SUPPLY CO. The
Radio Centre,
33, Tottenham Court Road, London, W.1. **MUSum 6667.**

TECHNICAL TRADING CO.
SPECIAL GUARANTEED SNIPS

128 (CR100) COMMUNICATION RECEIVERS.—10-4,000 metres. Xtal. Complete 11 valves, good condition, untested, £12.10, carr. 12/6.
COSMOR 333 D.R. OSCILLOSCOPES.—Tested, good condition, £17.10, carr. 12/6.
AVO VALVE TESTERS.—Standard model, teak carrying case, good condition, £8, carr. 9/-.
TEST SETS TYPE 74A.—Oscilloscopes, 200-250 v. AC. Ideal conversion to standard scopes, £4.15, carr. 10/-.
TAPE RECORDER CASES.—Blue rexine, hinged lid, double locks, carrying handle, size 16in. w. x 12in. d. x 9in. h. 25/-, carr. 3/6. Ditto, beige, de luxe, surplus famous make. 45/-, carr. 4/-.
DICTAPHONE MOTORS.—AC DC with dropper for 200-250 v., silent, smooth, powerful, 5in. long, 3in. diam., long 4in. spindle, 17/6, 2/6 carr.
INDICATORS TYPE 95.—VCR97 Tube, 16 valves, 49/-, carr. 7/6.
CONDENSERS.—Latest ceramic, 10, 20, 50, 300, 1,000, 3,000 pf., 5/- doz., post 6d.
LATEST ELECTROLYTICS.—100 mfd, 6 vw, 1/-; 3 mfd, 250 vw, 1/3; 16+16, 350 vw, 3/-.
RESISTANCES.—1 w. ceramic, 47Ω-1 mΩ, 2/- doz, 10/- 100.
AMPHENOL VALVEHOLDERS.—Octal, B8A, B7G, B9A, B9G, 6/- doz, B9A w/screen, 1/3, 12/- doz.
V.V. PRESET POINTS.—500Ω, 1K, 2.5K, 5K, 10K, 20K, 25K, 2/- ea. 8in. P.M. SPEAKERS.—Top makes, guaranteed perfect, ex-eqpt., 10/-, post 1/6.
TELEPHONE SETS.—Type "F", "L", and Naval sound power, good condition, complete 27/6, post 2/6.
12 volt 10020 v. AMPLIFIERS.—Inbuilt motor Gen. compact, ideal outdoor work, push/pull 6L6, and 2 double triodes, cost approx. £30, good cond., untested, £5.10, carr. 10/-.
RADIO VALVES GUARANTEED PERFECT
 6AK5 6/6 6F33 8/8 12AX7 8/- EF92 4/6 SP61 3/6
 6AG5 5/6 6J6 6/8 613 50/- EL91 5/6 SP210 3/6
 6AL5 5/- 6J7C 4/6 EB34 2/- E235 8/- U22 8/6
 6CA 6/6 615G 4/- EB31 8/- PY31 4/6 VR150/30 6/-
 6F6G 6/6 6K7M 6/- ECC31 8/- PY31 4/6 VR150/30 6/-
 1,000 OTHER BARGAINS TO CALLERS AT

PORTSMOUTH'S RADIO, TV AND TOOL SHOP
350/352, FRATTON ROAD, PORTSMOUTH

S. & R. ELECTRONIC PRODUCTS LTD.

"MULLARD" 3 WATT AMPLIFIER. A very low distortion of only 1½% High efficiency 3 ohms output Transformer. Wired and tested at £5.5.0.
S. & R. 3½ WATT AMPLIFIER. Similar to 3 watt amplifier but with twin triode mixer preamp stage allowing mixing of inputs, each separately controlled. Negative feedback. High efficiency output transformer for 3 ohms speaker. Separate variable tone control. Wired and tested at £5.5.0. Wonderful value.
S. & R. 8/9 WATT PUSH PULL AMPLIFIER. Twin input for records or F.M. unit. Switched and compensated for long playing and standard records. Large type S. & R. output transformer of very high efficiency. 2 twin triodes plus 2 latest all glass output pentodes and heavy negative feedback. Completely wired and concert tested. £15.15.0.
"QUALTAP" 2 SPEED RECORDING TAPE DECK. All metal. No push buttons. Mechanical brakes. No belt drives or clutches. Switch controlled speed change from top of deck plate. Price £17.17.0.
300 V.H.T. POWER PACK. 6.3 volts. 2½ amps C.T. Lt. complete with rectifier valve. 60 mills. Price £3.10.0.

Demonstrations given at Works on request.
NO EX W.D. VALVES USED.

These fine electronic products are detailed in our new illustrated list. Write for copy, enclosing 3d. postage stamp.

Some manufacturers:—

S. & R. ELECTRONIC PRODUCTS LIMITED
15 OTLEY ROAD, BRADFORD 3, YORKSHIRE.
TEL.: BRADFORD 31782.

IT'S NEW!
BUILD THIS
FRYING-PAN
RADIO FOR

Total building cost only 79/6 Post Free, including set of step-by-step, easy-to-follow plans, new polished frying-pan and everything down to the last nut and bolt. This is a real mains radio with built-in speaker, uses a well-tried and tested sensitive circuit, covers all medium and long waves, has excellent tone due to wall-baffle effect. Size only 9in. diameter, 2in. deep, with 7in. handle. Very robust—should last a lifetime. Hangs anywhere—mains lead passes unnoticed through handle. An absolute beginner can build this set in an evening using our simple step-by-step plans. Costs only 1d. for 65 hour's running (at usual cost of approx. 1d. unit). Ideal for Kitchen, Bedroom, etc. Build one for your Wife, Mother or Girl-Friend. (Parts can be bought separately, parts list, etc., 2/6). **SEND TO-DAY 1/- to EASTBOURNE RADIO, (Dept. PW) 30, OCKLYNGE ROAD, EASTBOURNE.** (Please cross postal-orders, etc.).



POST THIS COUPON NOW!

To Eastbourne Radio, 30, Ocklynge Rd., Eastbourne

NAME

ADDRESS

(Please cross postal-orders)

Dept. PW1

WHY WASTE TIME

Give that set its best chance
FIT QUALITY COMPONENTS

Catalogue 1/-.

Parts for the following:	Manual
Osram "912" Plus Amplifier	4/-
Mullard 10-watt Amplifier	3/6
The Coventry	
2-watt Amplifier	} 1/-
4-watt Amplifier	
6-watt Quality Amplifier	
The Coventry A.M. Tuner Unit	1/-
Denco F.M. Tuner Unit	1/6

Complete Component Price Lists will be supplied with each Manual

COVENTRY RADIO

EST. 1925
189, DUNSTABLE ROAD, LUTON, BEDS.
Phone: Luton 2677

RADIO
RECEIVER
CIRCUITS
HANDBOOK

By E. M. Squire. 4th Edition. A readable and not too technical description of all the important and commonly used circuits in modern radio receivers. Completely up-to-date. For the go-ahead practical radio man. Illus. 15/- net. From booksellers.

PITMAN
Parker St., Kingsway, W.C.2.

Open to Discussion



The Editor does not necessarily agree with opinions expressed by his correspondents

Atomic Power

SIR,—With reference to Mr. Hancock's letter on the mixing of hydrogen and oxygen to generate electricity, I believe he is referring to the "fuel cell." This, however, does not utilise atomic piles. Coal is converted into water-gas, a mixture of hydrogen and carbon monoxide. This gas is introduced into the pores of one of the electrodes of a special voltaic cell, the hydrogen being used up. The other electrode uses the oxygen in the air, again forced into the pores. A P.D. of about one volt appears across the electrodes. As the hydrogen in the water-gas comes from steam passed over the strongly heated coal, and the oxygen comes from the air, the fuel cell is very cheap to run.—M. J. TOWERS (N.21).

"An Unnecessary Scare"

SIR,—Your editorial note in the March issue of PRACTICAL WIRELESS dealing with the problem of electrical hand drills in the amateur's workshop calls for further comment.

Statistics show that, in industrial premises, 40 to 50 per cent. of all electrical fatalities are caused by portable apparatus, flexible cables, connecting plugs, etc., whilst approximately 35 per cent. of all electrical accidents are caused by such apparatus.

Earthing of such tools is, as you say, a safeguard, but efficient earthing must be combined with efficient protection to give any degree of safety. The amateur does not normally have the means for carrying out heavy current tests and without such testing there can be no guarantee that the safeguards are being maintained.

A broken or loose earth wire together with a broken cable strand or an accumulation of carbon dust can produce lethal conditions when the supply is 200/240 volts alternating current. It is for this reason, that the Factory Department of the Ministry of Labour and National Service recommends reduction of voltage, to a pressure not exceeding 110 volts, together with the earthing of the mid-point of the secondary winding of the step-down transformer.

Your suggestion that danger increases with heavier current equipment is far from the truth. Heavy duty industrial equipment will normally have a larger margin of safety than domestic apparatus and will be constructed to higher standards.—F. CLARKE, M.I.E.E. (H.M. Electrical Inspector of Factories).

Three-valve A.C./D.C. Receiver

SIR,—I understand the Olympic coils specified for the above receiver are no longer available. However, Weymouth coils may be used.

The Weymouth coils have the following type numbers, HA1 and HA3 aerial coils and HO3 and HO1 oscillator coils. One being the Medium waveband and 3 the Long waveband.

The white coloured tag on the coils connects to the switch. The red tag on the aerial coils goes to the A.V.C. line and aerial input. The red tag on the oscillator coils connects to the padder and switch.

The primary winding on the aerial coils is not used. The circuit diagram shows the switch in the Long wave position.—R. W. SHEPPARD (N.14).

Midget Receivers

SIR,—I was both interested and pleased to read the remarks of old friend "Thermion" with reference to midget receivers, in the January issue of PRACTICAL WIRELESS.

For some years before the war I tried out experimental midget rig-ups, with varying degrees of success. As is well known by "old-timers," the power from the L.W. station was much less in those days, with the result

that comfortable reception, at least here in Ireland, was very much more difficult, and, as Thermion so truly remarks, power for the Rx itself was a problem. I also experimented with vibrators, but found them unreliable. As sensitivity could not be sacrificed, instability was another trouble.

Since the war I purchased an ex-Government M.C.R.I. "pocket" Rx, and, since that, the components to rebuild it in a more useful way as a midget as described in PRACTICAL WIRELESS December, 1947, and January, 1948, but I regret to say this has not been done. There has been a reference to this rebuilding by one who actually did it in PRACTICAL WIRELESS April, 1948, but not enough to draw satisfactory conclusions.

How true it is that, "indeed it is radio which has made space-travel possible" (Thermion), and one wonders how the time-lag of space communication will affect methods of so doing, and how it will affect phone talks between Martin and Phoebe, with only ten minutes to make arrangements, as it takes approx. this length of time to reach Mars by the fastest means known!—M. K. HUGGARD (Co. Wicklow).

Records and Record Wear

SIR,—Due to the growing enthusiasm for better record reproduction, I would like to say a few words about turntables, pick-ups, preamplifiers, amplifiers and loudspeakers.

I have personally found that most players under £10 seem to have too much rumble when the asso-

Whilst we are always pleased to assist readers with their technical difficulties, we regret that we are unable to supply diagrams or provide instructions for modifying commercial or surplus equipment. We cannot supply alternative details for receivers described in these pages. WE CANNOT UNDERTAKE TO ANSWER QUERIES OVER THE TELEPHONE. If a postal reply is required a stamped and addressed envelope must be enclosed with the coupon from page iii of cover.

ciated equipment has a bass response down to 30 c/s. A really good quality player will need a heavy turntable of about 8 lb., and accurately made pulleys or idler wheels, all to eliminate wow. To eliminate rumble the turntable should be mounted on a non-vibrating bearing and there should be no connection through solid materials between this bearing and the motor with drive mechanism, so the motor and drive mechanism should be rubber mounted on the solid base plate. Mr. E. T. Hurst did not seem to understand this.

Most "high fidelity" 10-watt amplifiers, as described and advertised in PRACTICAL WIRELESS are very good and are a matter of personal choice.

It is a good idea to hear as many loudspeakers as possible so that you are able to buy the best you can afford. Suitable cabinet dimensions can be obtained from the makers.

Finally, I would like to say, judge equipment by your own ears and don't become so "Hi-Fi" minded that you almost invariably try to find technical faults when listening to records, after all it is the record itself that really counts.—D. D. MACDONALD

F.M. Oscillator Harmonics

SIR,—May I congratulate you on your article describing an F.M. receiver in your December/January issues, which I have recently re-read.

Of the various circuits published yours is the first I have seen that makes any attempt to utilise some of the ex-W.D. valves that fill our drawers, but why not EF54s in the H.F. strip?

The author complains that harmonics of an oscillator are not labelled. Perhaps not, but they are easily identifiable.

Whilst the patient constructor is making the little oscillator he can go just a little further and calibrate it. Let him find a small variable condenser in his junk box and wire it across the tuning coil and then calibrate the dial against the short-wave scale on his domestic set. This should be done carefully and the accuracy of the receiver checked against actual transmissions, any deviations being noted. He must make sure that the calibration of the oscillator is on fundamentals and not on second harmonics. This is easily checked. Having established between the "single band signal generator," and the receiver, an identity at the high wavelength end of the scale somewhere round 45 metres—a strong hiss or a pop indicates this—he turns the receiver indicator towards the low wavelength. If he was on fundamental at say 44 metres he will hear a pop or hiss at 22 metres and not before.

With this improvised signal generator he proceeds to line up the F.M. set. The intermediate frequency will be 28 metres (10.7 Mc/s). The calibration of the S.G. would be better in megacycles.

For the H.F. alignment our constructor will set the S.G. at 9 Mc/s and line up on the tenth harmonic (we hope) until he gets a signal through the set.

Having got so far he must confirm that he has been working on the tenth harmonic (90 Mc/s). It could be the 11th (99 Mc/s) or even the ninth (81 Mc/s). Let him turn the dial of the S.G. towards the higher frequency end of the scale until he is on the next harmonic. Of the new S.G. scale reading this will be the ninth harmonic, if all is well. The formula is:—

$$\left. \begin{array}{l} N = \text{No. of harmonic} \\ a = \text{1st setting of S.G.} \\ b = \text{2nd setting of S.G.} \end{array} \right\} \text{ then } \begin{array}{l} NxA = (N-1)b \\ aN = bN - b \\ bN - aN = b \end{array}$$

$$N = \frac{b}{b-a}$$

N, of course, refers to the first scale reading.

If our friend finds that he was not on the tenth harmonic, as hoped, he must move his cores in or out until he finds the next harmonic—it is unlikely that he will be more than one out. It would be even better perhaps to set the S.G. at 15 Mc/s and try for the sixth harmonic.

There is another method of identifying harmonics which is hardly applicable here since it involves the exact calibration of the capacitance of the variable condenser of the V.H.F. set. The idea is to determine the difference of tuning capacitance between three adjacent harmonics at V.H.F.

Let the harmonics be x, y, z, and let ΔC be the difference in capacitance between x and y and $\Delta_2 C$ the difference between x and z. Then

$$N = \frac{\Delta_2 C - 4\Delta C}{4\Delta C - 2\Delta_2 C}$$

N is the number of the highest harmonic "z."

The fundamental being known, then $Nf_1 =$ frequency of harmonic.

The equation is of academic interest only. I cannot think of any practical application.

There appears to be a small error (0) in the de-emphasis network of your F.M. set.

Finally, may I suggest that one ought to be able to assume a knowledge of school certificate maths. In any reader bold enough to construct a V.H.F. receiving set.—"RADIOPATH."

Organ Tone Controls

SIR,—Since the publication of construction details of your Electronic Organ I am wondering if any of your readers have made any experiments in regard to tone control, or any quick-change switching device to give instant changes from say, violin tone to oboe or clarinet?

The five switches gave a fair amount of change, but left something to be desired for one who is used to combination pistons on a church organ!

It would be interesting to hear of any new design which would take this important feature into account, and I should be glad to hear from any reader who has improved on the original design in this respect.

—A. DICKINSON (Leeds, 8).

Editorial and Advertisement Offices:

"Practical Wireless," George Newnes, Ltd., Tower House, Southampton Street, Strand, W.C.2. Phone: Temple Bar 4303.

Telegrams: Newnes, Rand, London.

Registered at the G.P.O. for transmission by Canadian Magazine Post.

The Editor will be pleased to consider articles of a practical nature suitable for publication in "Practical Wireless." Such articles should be written on one side of the paper only, and should contain the name and address of the sender. Whilst the Editor does not hold himself responsible for manuscripts, every effort will be made to return them if a stamped and addressed envelope is enclosed. All correspondence intended for the Editor should be addressed: The Editor, "Practical Wireless," George Newnes, Ltd., Tower House, Southampton Street, Strand, W.C.2. Owing to the rapid progress in the design of wireless apparatus and to our efforts to keep our readers in touch with the latest developments, we give no warranty that apparatus described in our columns is not the subject of letters patent. Copyright in all drawings, photographs and articles published in "Practical Wireless" is specifically reserved throughout the countries signatory to the Berne Convention and the U.S.A. Reproductions or imitations of any of these are therefore expressly forbidden. "Practical Wireless" incorporates "Amateur Wireless."

TO BE SURE



I CAN'T FIND WHAT'S WRONG - GUESS I'VE WASTED MY TIME AND MONEY ON JUNK!

GET THE RODING 22-circuit HOME



"If you want to save time and money!"

CONSTRUCTOR'S HOME HANDBOOK

Our latest issue is beautifully printed on glossy art paper with a full colour cover! Packed with technical data, set building and servicing hints, facts and formulae, resistance colour code, soldering hints, etc., together with descriptions, full parts lists and circuits of world-famous outfits as listed below. Send 2/6 (plus 4d. post).

- ★3-valve superhet Feeder Unit.
- ★4-valve superhet Feeder Unit (R.F. stage), with hi-fi and gram, switching.
- ★Amplifier Power pack for both above.
- ★5-valve Superhet A.C. with gram.
- ★5-valve Superhet A.C. D.C.
- ★6-valve Superhet A.C. (R.F. stage).
- ★6-valve Superhet A.C. D.C. (R.F. stage).
- ★Simple Continuity Tester.
- ★Magic Eye unit.
- ★Modified 40 Feeder Unit Circuit.
- ★"P.W." Coronet AC4 Superhet.
- ★"P.W." Coronet A.C. D.C. 4 Superhet.
- ★"P.W." Coronet Battery 4 Superhet.
- ★Tape Recorder.
- ★3-in. Oscilloscope.
- ★8-valve Communications Receiver.
- ★Signal Tracer.
- ★5-watt quality Amplifier.
- ★10-watt high-fidelity push-pull Amplifier.
- ★Signal Generator.
- ★Crystal Set.
- ★Local station high-fidelity T.I.F. Feeder unit.

Our renowned "Easy-as-A.B.C." FULL SIZE Construction Sheets are available FREE, with orders enabling even the beginner to get professional results first time! Coll Packs and I.F.T.s pre-aligned. We supply ALL parts for ALL circuits.

NEVER BEFORE HAS THERE BEEN A BOOK SO VALUABLE TO NOVICE AND EXPERT ALIKE!

RODING LABORATORIES

(Dept. TC7) Bournemouth Airport, Christchurch, Hants.

VALVES SAME DAY SERVICE

All Guaranteed New and Boxed

14V. midget.	1R5, 1S5, U05, 1T4, 3S4, DAF91, DF91, DK91, DL92, DL94; any 4 for 27/6
14GT	6Q7GT 9/6 DH77 8/6 IGZ32 15/- 12/6 6SN7GT DK32 12/6 HVR2A 7/- 15CGT 11/- 8/6 DK92 7/6 KT33 10/6
1D5 11/-	6U4GT 15/- DL33 11/8 10/6
1H5GT	2V6G 7/6 DL35 11/- KT63 7/6
11/8	6V6GT 7/6 EB91 6/9 MU14 9/-
1NSGT	6X4 7/6 EBC33 7/6 P61 5/6 11/6 6X5GT 6/9 EBC41 10/- PCC84
1R5	8/6 7E7 8/6 EHF80 10/- 9/6
1S5	7/3 7C5 8/6 ECC90 9/-
1T4	7/3 7C8 8/6 ECC80 15/6 PCF82 11/8
1U5	7/3 7H7 7/6 ECC83 10/6 PEN45 18/-
3A5	9/- 7S7 8/6 ECC83 10/6 PEN46 7/-
3Q5GT 11/6	7Y4 8/6 ECC91 6/6 PEN46 7/-
3S4	7/6 10C1 13/6 ECF80 15/- PL38 23/9
3V4	8/6 10C2 10/- ECH35 PL81 11/9
5U4G	8/6 10F1 10/- 11/9 PL82 8/8
5Y9GT	7/9 10LD11 10/- ECH42 PL83 12/6
5Z4G	9/- 10/6 10/6 PY80 10/-
6AK5	5/- 12AT7 9/6 ECH81 9/6 PY81 10/-
6AL5	6/9 12AU7 8/6 ECL80 10/- PY82 9/6
6AM5	5/- 12J7GT 8/6 ECF7A PZ30 18/-
6AM6	7/6 10/6 10/6 U22 10/6
6AQ5	7/6 12K7CT 9/6 EFB39 6/6 U25 18/6
6AT6	8/6 12K8GT EP40 17/6 U26 15/6
6BA6	7/9 12/6 EP41 10/- U50 7/9
6BE6	7/6 12Q7GT EP42 14/- U78 7/6
6BW6	7/9 9/6 EP50 7/6 U404 9/-
6BX6	7/6 12Z3 9/6 EP80 10/- UAF42
6C9	10/- 14S7 15/6 EP85 9/6 11/9
6F1	14/6 20L1 10/9 EP86 12/6 UBC41 9/-
6F6G	7/6 25L6GT 8/6 EP91 7/6 UCH42
6F15	13/- 25Z4G 8/6 EP92 5/- 10/9
6J6	6/- 35L6GT 8/6 EP93 6/6 UF41 9/8
6J7GT	7/6 35Z4GT 8/6 EL38 23/9 UL41 10/9
6K7G	6/- 35Z5GT 9/- EL41 11/6 UC7 11/6
6K7GT	6/- 50L6GT 8/6 EL84 11/6 UY41 9/-
6K8G	8/6 D15 7/- EM34 10/6 W77 5/-
6K9T	9/6 DAC32 11/6 EMB 12/6 W83 12/6
6L18	10/8 DCC90 9/- EZ40 9/6 Y83 7/6
6LD20	9/6 DF33 11/6 EZ80 9/- Z77 7/6

Postage 5d. per valve extra.
READERS RADIO
24, COLBERG PLACE, STAMFORD HILL, LONDON, N.16. STA. 4587

BARGAINS GALORE!
BARGAINS IN TOP QUALITY VALVES!
MAKERS' CARTONS — 6K6GT, 5/9; 6SH7, 4/9; 6H6, 2/9; 6SK7, 5/9; VU111, 2/9.
UNUSED BOXED — 12H6, 1/3; KTZ63, 5/-; 80, 7/6; 6Q7GT, 7/6; EB34, 1/9; 6J7, 5/9; 8F41, 2/9
VALVE HOLDERS — Octals, B9A, B9A, B9G, 1/- with screens 2/-
PLUGS FOR VALVE HOLDERS — International Octal 2/3, B7G, B9A, 1/9.
CLEARANCE UNUSED CARBON RESISTORS (Famous make). — 5 watt 700Ω, 2K, 4K, 5-6K, 20K, 30K, 200K, 44 (5/- doz.); 2 watt 36Ω, 100Ω, 330Ω, 5K, 15K, 300K, 500K, 44 (3/- doz.); 1 watt, 20Ω, 12K, 15K, 75K, 150K, 180K, 3d. (2/6 doz.); 1/2 watt, 30Ω, 33Ω; and 1/2 watt, 1K, both 2d. each (1/9 doz.). (Nearly all the above will accept 100% overload.)
UNUSED POTENTIOMETERS (with spindle). — 500K, 6K, 1/3 or 4 for 5/6.
MIDGET 500V. CERAMIC (For a QUALITY job). — 4-7, 7-5, 10, 15, 22, 27, 33, 39, 47, 56, 75, 100, 150, 200, 270, 330, 390, 470, 1,000, 2,000, 3,000 pf., 9d. each; 8 1/2 doz. (5,000, 10,000 pf., 1/- each).
ELECTRONICS — 40 mfd., 1,000 v., 3/7; 32+32 mfd., 450 v., 4/3; 32+16 mfd., 350 v., 3/9.
LOW LOSS COAX — Latest cellular polythene, suitable Band I or 111, 9d. yd.
COAX FITTINGS — Solderless joint, 1/2; socket, 1/3; outlet box, 4/6; coupler (double socket), 1/6; Line connector (permanent joint), 1/3.
WIRE WOUND RESISTORS (Silicone coated). — 25, 50, 100, 150, 200, 250, 300, 1,000, 1-5K, 2K, 2-5K, 3-5K, 5K, 6-8K, 10K, 5 w., 1/3; 10 w., 1/6; 15 w., 1/9; 1K, 2K, 20K, 25K, 33K, 5 w., 1/9, 10 w., 2/3; 47K, 5 w., 2/3; 10 w., 2/6.
JONES PLUGS AND SOCKETS. — (6 way or 10 way), less covers, 9d. pair.
SLEEVOING. — Assortment of 4 colours, from 1 to 2 mm. bore, 36 yds., 2/6 (post 6d.). (2 gross yds., 1 mm. bore, green, 12/6. med. 2/-.)
LATEST "GEN" BOOKS
PRACTICAL TRANSISTORS & TRANSISTOR CIRCUITS. — Build these new exciting circuits now using your own cheaply made transistors, 3/6, post. 5d.
RADIO CONTROLLED MODELS FOR AMATEURS. Theory and construction, various systems, 5/-, post. 4d.
PRACTICAL F.M. — P.M. Fully explained, with lots of circuits for home constructors, 5/-, post. 4d.
VALVE EQUIVALENTS. (Genuinely at-a-glance) 5/- SEND 3d. FOR FULL BARGAIN LIST.
Please allow post and packing on orders under 1l.

REED & FORD 2A, BURNLEY RD., AINSDALE, SOUTHPORT.

BUILD THIS FOR 49/6



Build this exceptionally sensitive twin-triode radio. Uses unique assembly system and can be built by anyone without any radio knowledge whatever in 45 minutes. Handsome black-crackle steel case with specially made black and gold dial with stations printed. Size of radio only 6 1/2 in. x 5 in. x 3 in. Covers all Medium and Long waves — uses one only all-dry battery. H.T. consumption only 1 to 1.5 mA. Ideal for Bedroom, Garden, Holidays, etc. Many unsolicited testimonials. Mr. Norton, of Oxted, writes: "Yesterday evening on the Medium waveband, I counted 32 separate stations. I am very pleased with the set, which is well worth the money. Total building cost — Everything down to last nut and bolt — 49s. 6d., including post, etc., with full set of clear, easy-to-follow plans (For Headphone Reception). Cost of Extra Valve, Speaker, Parts, etc., 38s. 6d. All these fit inside Case or parts sold separately. (Priced Parts Lists, 2/-.) Orders despatched by return. Overseas orders welcomed. SEND TO:—

CONCORD ELECTRONICS (PW7), 39 QUEEN'S ROAD, BRIGHTON, 1

BENSON'S BETTER BARGAINS

VIBRAPACKS, Mallory, 12 v. D.C. to 250 v. 80 mA., synch. reversible, new, 17/8; Jefferson/Travers, synch., 250 v. D.C. to 150 v. 40 mA., smoothed, black crackle case, 16/- (Post each 2/9). DYNAMOTORS, D.C. 6 v. to 250 v. 80 mA. output, 10/6; Filters H.T./L.T. 2/6; Eddystone, 12 v. D.C. to 190 v. 75 mA., smoothed, enamel, 15/- (Post 2/9); 11 v. D.C. to 300 v. 200 mA., enamel, 21/- delivered. T.C.S., D.C. 12, 12 or 24 v. to 225 v. 100 mA. and 440 v. 200 mA., 52/6 delivered. Portable RADIATION MONITOR 39952/13, with Geiger; 110p/20 v. A.C. input, £12/10/-; METERS, 1 mA. P.S.D. M.C. 3 1/2 in. dial, flush mtg., Weston, 45/-; SPLITTERS, 15 a.c. G.E.C., D.P. switch, 4 fuses, new, 15/6. RX159 160/220 m.c.s. with 1VR65, 1VR17, 1VR92, 1CV66, 12/8; I.F. AMPLIFIER 178 (for this), 15/6 m.c.s. with valves, 17/8 (postage 2/6 each). CLOCKWORK (contactors, 3 impulses per sec., 8/6. U.S.A. type, small, 9/6. R1355, new improved type, 3/6 (carr. 7/6). R1392A, DAMAGED METERS, 160/150 m.c.s., 13 valves used, good condition, 24 (carr. 10/-). CONDENSERS, Bak. (tubular), 20, 1/2, 1/4, 1/8, 100 v., 25/800 v., 8d. each; 40/25 kV; 65/35 kV; 25/1.5 kV; 1/4; 1/8; 1/3; 5 kV 4/6. RESPONDER, RDPI. New, 160/220 m.c.s., 12 valves, 15/- (carr. 7/6) or ZC8831 9 valves, 30/- (carr. 4/-). BENDIX RA-10DA/DR, 4 Wavebands; Long, Med., 2.5 and 5-10 m.c.s., 8 valves. New, 24 (carr. 10/-). RELAYS, 9 v. 2 break, 1/6. R1355 IF Strips only, complete new with valves, 25/-; less valves, 12/6 (post 2/6). BRAND NEW R.F. UNITS, TYPES 26 or 27, 27/8; (Postage 2/6); R124, R125. SLOTTED 10/8. I.F.T.'S 10/13 m.c.s., canned, new, 1/3. R1155 Outpicks, new, 12/6. Used, 9/6. POWER PACK, new 200/260 v. A.C. input. Output 250 v. D.C. 80 mA., 6.3 v. 3A and 24 v. 1 A. 11/- (carr. 2/9). AUTO-TRANSFORMERS, 110/220 v. 450 w. New, 80/-, list and enquiries, S.A.E. please! Terms: C.W.O. Postage extra. Immediate despatch. Callers Post Callers

W.A. BENSON (P.W.) SUPERADIO
308, Rathbone Rd., Whiteapel LTD., 116, Liverpool 13. Whiteapel, Liver- STO 1604 post 1. ROY 1130

RECEIVERS & COMPONENTS

MAKING YOUR OWN? Telescopes. Enlargers, Projectors, or, in fact, anything using lenses. Then get our booklets "How to use Ex-Gov. Lenses & Prisms," price 2/6 ea. Comprehensive lists of optical, radio and scientific equipment free for s.a.e. H. W. ENGLISH, Rayleigh Rd., Hutton, Brentwood, Essex.

AMERICAN RADIO Plans and Devices. Now available. Hundreds of new and startling devices you can make. Only designs of this type available in UK. Receivers, walkie talkies, amplifiers, recorders, magic eye alarms, etc. Full lists, data, illustrations. Free for stamp. Send to-day.—A.P.S. (P.W.), Sedgford, King's Lynn.

LOUDSPEAKERS repaired promptly. MODEL LOUDSPEAKER SERVICE, Bullingdon Rd., Oxford.

MIDDLEBROUGH. Largest stocks on N.-East coast, Radio, TV components, P.M. Kits, Gram Cabinets, Tape Decks, Leak Amplifiers, Valves, etc. Callers only. PALMERS, 106, Newport Road. (Phone: 3096.)

B.S.R. Monarch 3-speed Autochange Units, new, in maker's sealed carton, guarantee, complete with instructions, template, suspension springs, £9/15/-; carriage paid; immediate delivery. TOMLINS, 127, Brockley Rise, Forest Hill, S.E.23.

TELEVISION, 9in. Models. £6/10/-; 12in. Models, £15; all makes working; carriage paid. TOMLINS, 127, Brockley Rise, Forest Hill, S.E.23.

OSMOR would like you to have Free Practical Wiring, Diagrams of the latest published circuits with full lists of components required. Send 7d. (stamps) to OSMOR RADIO PRODUCTS LTD., 418, Brighton Rd., 5th, Croydon. (Croydon 5148.) (See advert., page 319.)

R.F. UNITS, Types 27 or 26, 25/-; 25 or 24, 10/-; brand new with valves; post 2/6. E.W.S. CO., 69, Church Rd., Moseley, Birmingham.

SEVERAL EARLY MODELS 9in. Television, complete and mostly working, £5/15/- each; carriage paid. TOMLINS, 127, Brockley Rise, Forest Hill, S.E.23. (FOR 5497.)

THE HIWAYMAN. A new super Portable Radio for the home constructor; all-dry 4-valve superhet with Ferrite rod aerial; easy wiring diagrams and instructions, 1/6 (post 3d.). RADIO EXPERIMENTAL PRODUCTS LTD., 33, Much Park St., Coventry.

R.F.26 10/-, R.F.27 15/-, R1124 £1, V.C.R.97 £1, C.R.T. 63D.S., as V.C.R.97 but 12in., £4, 43, St. John's Rd., Walthamstow.

GUARANTEED TELEVISION, 12-in. models, first-class picture, 5-channel, £30 each; carriage paid. THE GRAMOPHONE SHOP, 19-21, Brockley Rise, Forest Hill, S.E.23.

TV IN PERFECT WORKING ORDER from £14, carriage paid; all makes; many sets suitable use anywhere. Impossible to show complete stocks here. Send s.a.e. for lists of latest bargains. 10in. Marconi £14, 9in. Ekco £15, 12in. Ekco £22/10/-, 12in. Ferguson £24. THIS IS A GENUINE OFFER — NOT A "CATCH." 100's SOLD EVERY WEEK. Callers welcomed. HIGH STREET RADIO, 284-6, High St., Croydon, Surrey. (Phone: CR0Ydon 9015.)

ENGRAVING.—Amateurs and trade surplus can be undertaken by getting in touch with A. G. ENGRAVING, now at 292, Earlsfield Rd., London, S.W.18. (BAT 9697.) (Engravers to well-known makers of Electronic Equipment used by the Aircraft Industry, A.W.R.E., etc.)

RATES: 5/6 per line or part thereof, average five words to line, minimum 2 lines. Box No. 1/- extra. Advertisements must be prepaid and addressed to Advertisement Manager, "Practical Wireless," Tower House, Southampton St., Strand, London, W.C.2.

ELECTROLYTICS, capacity, voltage, size, type of mounting, price post paid. 250 + 250, 6v, 1in. x 2in., lug. 1/6; 1,000 + 2,000, 6v, 1 x 3, clip, 3/9; 250, 12v, 1/2 x 1 1/2, clip 1/9; 500, 12v, 3/4 x 1 1/2, W/E, 2/-; 10, 25v, 1/2 x 1 1/2, clip, 1/3; 25, 25v, 1/2 x 1 1/2, W/E, 1/6; 50 + 50, 150v, 1 1/2 x 2, clip, 2/9; 100, 275/350v, 1 1/2 x 3, clip, 3/3; 24, 275v, 1 1/2 x 2, clip, 3/-; 60 + 250, 275/350v, 1 1/2 x 4 1/2, clip, 6/3; 16 + 16 + 350/425, lug, 4/3; 8, 450v, 1 x 2, clip, 1/8; 15 + 15, 450v + 2, 25v, 1 x 3, lug, 4/3; 20 + 10, 450v, 1 x 3, clip, 4/-; 8, 500v, 1 1/2 x 2 1/2, clip, 2/6; 32 + 32 + 2, 350/425v, 1 1/2 x 2, clip, 4/3; 5, 150v, 1/2 x 1 1/2, W/E, 1/3; 8 + 8, 450v, 1 x 2, clip, 3/9; 100, 350/425, 1 1/2 x 3, clip, 4/-; Photoflash Type, 1,000 mf., 200v, wkg., 1 1/2 x 4 1/2, clip, 12/6; all Ali Cans, some with sleeves, all voltages, wkg., sure where marked, new stock guaranteed. Television Chassis, cadmium plated steel, size 13 x 13 x 2 1/2in., complete with 13 valveholders (9-B9A Pux, 1-B9A Cer., 2-B7G Cer., 1-Int. Oct. Amph.), 20 various tag strips, cut away for metal rec. line trans., etc., 9/11 each, post paid; front and rear tube mounts to fit above chassis, 3/- pair, post paid. P.M. focus Magnets, wide angle, tetrode tube, fully adjustable, 42/-, post paid. Scanning Coils wide angle, with mounting lugs, 19/6, post paid. Vision I.F.s (2nd, 3rd and 4th), freq. 34 mc/s, slug tuned, size 13/16 x 13/16 x 2 1/2in. can, set of 3, 5/6, post paid. Mains trans. 250-0-250v, 120mA, 6.3v, 2.5A, 6.3v, O.6A. Pri. 0-110-125-150-205-225-245v, 17/-, postage paid. RADIO CLEARANCE LIMITED, 27, Tottenham Court Road, London, W.1. (Telephone: Museum 9188.)

AMERICAN MAGAZINES. One year's "Audio," 35/-; "High Fidelity," 50/-; Specimens 4/- and 5/-, respectively. Full list from WILLEN LTD. (Dept. 40), 9, Drapers' Gardens, London, E.C.2.

SERVICE SHEETS, T.V. and Radio, over 2,000 models, sale or hire; Valves and Components, S.A.E. with enquiries. W. J. GILBERT, 24, Frithville Gardens, London, W.12.

SERVICE SHEETS for Hire. Radio, TV, Components, Valves, etc. supplied. Send stamp for list. M. FOY, 6, Wykebeck Gardens, Leeds, 9.

"HI-FI" REPRODUCER, with Radio Tuner, less cabinets, never used. Box 273, c/o PRACTICAL WIRELESS.

I.T.A. CONVERTERS. Huge purchase brand new "Validus" 2 Valves, incorporating R.F. Amplifier and self-contained Mains Unit. Price £5/10/-, carriage paid. HARMONY HOUSE SOUND AND SERVICE LTD., 116, Cambridge Road, Churchtown, Southport.

SEND TO-DAY for our stock list of T.V. and Radio Bargains. C.R.T.s, Valves, Speakers and all Components. We are the cheapest people in the trade. All goods sold by us are guaranteed. VIDEO ELECTRONICS (LONDON) LTD., Dept. P.W., 16/22, Bacon Street, London, E.1.

FM-KIT SETS, Type P4, combines med. wave and power supply with push-pull output, price £19. Type PA for FM only, £5. Completed receivers: A £7/10/-, P4 £23. Kits are aligned for you. Guaranteed valves and components. Demonstrations at Marlborough Yard, Archway, N.19.

465 Kc/s I.F. Transformers. Litz wound, cans 2 1/2in. x 3 1/2in., 5/6 per pair; Dual-wave Ferrite-rod Aerials, Litz wound, 8/6; 1 meg. Pots, D.P. Switch, 2 1/2in. spindle, 3/3; Output Transformers, 6,000 to 3 ohm, 4/-; p. and p. extra. OLIVERS, 55, Havelock Rd., Torquay.

SUPER-TONIC SUN-RAY LAMPS. Ultra-Violet Infra-Red combined. Super therapeutic quality, controlled output, automatic exposure. All mains. Listed £7/10/-; our price 80/-, S.A.E. Illustrated brochure, Dept. 14, SCIENTIFIC PRODUCTS, Cleveleys, Lancs.

SERVICE SHEETS, Radio, TV. 4,000 models. Lists 1/-. Enquiries S.A.E. TELRAY, 11, Maudland Bk., Preston.

100 ASSORTED CONDENSERS, 2/6. This bargain parcel of assorted condensers at this very cheap price is a must for every amateur's shelf, post 2/-. O.P. Trans., 1/3, std., 2-5 ohms, guaranteed, post 9d. Send 21d. stamp for free catalogue of Radio Sets, Components and TV. Tubes. DUKE & CO., 621, Romford Road, Manor Pk., E.12. (GRA 6677.)

HOLIDAYS

JERSEY HOLIDAY.—Ham Shack; photo darkroom; s.a.e. for brochure, GC3KPO, "The Lincoln," 3, Saviours Rd.

SITUATIONS VACANT

UNIVERSITY COLLEGE HOSPITAL, IBADAN, NIGERIA, ELECTRO-MEDICAL TECHNICIAN, STORES AND SUPPLIES DEPARTMENT.—Applications are invited for the above-mentioned appointment from suitably qualified and experienced candidates, who can undertake repairs of electro-medical instruments, diathermy, physiotherapy and E.G.C. apparatus. Candidates must have had a good practical training and be able to carry out repairs of electro-medical equipment and minor repairs to surgical instruments and to train and supervise selected Nigerian craftsmen in this work. The officer appointed will be required to organise this section of the new Teaching Hospital and to assist when required in the general work of the department. Salary scale: £627 p.a. to £1,254 p.a. (maximum), plus inducement addition of £180 to £240 p.a. for expatriate officers. Entry point depends upon experience. Gratuity payable on satisfactory completion of contract at the rate of £25 (or £37/10/- when emoluments exceed £1,000 p.a.) for each completed period of 3 months' service. Outfit allowance £60 on first appointment. Expatriate officers are provided with partly furnished quarters at low rental, free 1st class passages for themselves and wives, children's allowances and liberal leave in U.K. Duration: Initial contract two tours of 12-18 months renewable by mutual agreement. Superannuation: Members of N.H.S. or F.S.S.N. may obtain relevant terms on application. Applications should be submitted not later than 22nd June, 1956, on forms obtainable with further particulars from London Executive Representative, 57, Catherine Place, London, S.W.1.

BOOKS

I.P.R.E. TECHNICAL PUBLICATIONS, 6,500 Alignment Peaks for Superheterodynes, 5/9, post free. Data for constructing TV Aerial Strength Meter, 7/6. Sample copy. The Practical Radio Engineer, quarterly publication of the Institute, 2/-; membership and examination data, 1/-; Secretary, I.P.R.E., 20, Fairfield Rd., London, N.8.

FOR SALE

RAD.-GRAM. CABINETS, slight reject. £20/10/-, £29/15/-, £12/10/-, 9.5.30 weekdays, also Sunday mornings. **RENNICK,** 40, Redchurch St., London, E.2. (Bis 1758.)
 "P. W.", 1935-45, 33 issues, Feb. 46-Dec. '51 (complete ex 4 issues). Offers to Box 274, c/o PRACTICAL WIRELESS.
ENERGISED LOUdspEAKERS, Hartley Turner, R.K., etc., £2 each, or offers. Transformers, Chokes, Condensers, suitable for transmitter power packs. Inspection invited week-ends, 60, St. Mark's Rd., London, W.10.

VALVES

ALL TYPES of new radio valves wanted, small or large quantities; cash payments. **R. H. S. LTD. (W.),** 155, Swan Arcade, Bradford, 1.
WANTED, PL81, EY51, ECL80, KT61, 6U4GT, VLB1, 35Z4, etc., etc., prompt cash. **WM. CARVIS LTD.,** 103, North Street, Leeds, 7.
ALL TYPES of Valves required for cash. State quantity and condition. **RADIO FACILITIES, LTD.,** 38, Chalcut Road, N.W.1. (PRIMrose 8090.)

EDUCATIONAL

CITY AND GUILDS (Electrical, etc.) on "no pass—no fee" terms. Over 95% successes: For full details of modern courses in all branches of Electrical Technology send for our 144-page handbook—free and post free. **B.I.E.T. (Dept. 242A),** 29, Wright's Lane, London, W.8.
MERCHANT NAVY Wireless School, Overseas House, Brooks' Bar, M/CR 16.
THE WIRELESS SCHOOL, Day, Evening and "Radiocerts" Postal Courses; s.a.e. for prospectus. **THE DIRECTOR,** 21, Manor Gardens, London, N.7.

STAN WILLETTS

43, SPON LANE, WEST BROMWICH, STAFFS. Tel: WES 2392.
VALVES BRAND NEW VALVES GUARANTEED
SPECIAL OFFER "6" Valves for 12/6 6KT6, EP50, EP36, EL32, TT11, SP61, ANY 5 VALVES 9/6.
 SP61, TT11, ATP4, EA50, 6BB9. Set of 4 battery valves. DP91, DAF91, DK22, DL94, 28/9, 7/6 each.
 6SN7, 7/6. 6SL7, 7/6. 6KT6, 3/9. 6KT6, 4/6. 6J5M, 4/6. 6AQ5, 6/9. 6K8C, 7/9. 6SG7M, 4/6. 6X4, 5/9. 7C5, 7/6. 10F1, 9/6. 12AU7, 7/6. 12AG, 5/11. 12BB6, 5/9. 50L6, 8/3. DH76 (12Q7), 7/6. W76 (12K7), 7/6. U76 (8F75), 7/6. 6BC33, 7/6. EP39, 7/6. EP36, 3/9. EP37A, 9/6. EP80, 8/6. EP92, 5/6. EY51, 10/9. EY86, 11/6. EL84, 9/6. EP54, 4/6. PCL83, 9/6. PL33, 11/6. PY8, 9/6. PEN46, 6/6. UF41, 8/6. UBC41, 8/6. UCH42, 9/6. UY41, 8/6. V63, 4/6. P & P, extra.
GERMANIUM CRYSTAL DIODES, G.E.C. 1/- each, 9/6 doz. P & P 3d.
"TRIPLET" 1 m.a. meter, rectifiers. Brand New with circuit, 5/6. P & P 3d.
NEW VALVES WANTED.

MORSE CODE Training

Send for the Candler **BOOK OF FACTS**
 It gives details of all Courses which include a Special one for acquiring amateur licence.
CANDLER SYSTEM CO. Dept. 5LO 52b, Abingdon Road, London, W.8.
 Candler System Co., Denver, Colorado, U.S.A.

ANNAKIN'S BARGAINS

Responser W.4790A. 5—VR65, 1—VR133, 1—VR137, 2—VR92 (less Relay). Store soiled, 17/-.
 Receiver P25 W.4049A. 5—VR65, 1—VR137, 2—VR92, 1—VR133A, 1—S26A. High cycle power pack (less 5Z4), soiled, £1/-.
 RF24, 9/3. RF27, 23 3 (dam. dials).
 1134A Battery Amplifier, with 2 valves, 7/3. Magnetic Microphones type 48, 2/9. Free Lists. All Carriage Free.
25 ASHFIELD PLACE, OTLEY, YORKS

THE INSTITUTE of Practical Radio Engineers Home Study Courses are suitable coaching text for I.P.R.E. and other qualifying examinations. Fees are moderate. Syllabus of seven modern courses post free from **SECRETARY, I.P.R.E.,** 20, Fairfield Road, London, N.8.

FREE! Brochure giving details of Home Study Training in Radio, Television, and all branches of Electronics. Courses for the Hobby Enthusiast or for those aiming at the **M.Brit.I.R.E., City and Guilds, R.T.E.B.,** and other Professional examinations. Train with the college operated by Britain's largest Electronics organisation. Moderate fees. Write to **E.M.I. COLLEGE OF ELECTRONICS, Dept. PW28, London, W.4.**

THERE IS a national shortage of Mercantile Radio Officers. Why not make Communications your career? You can be assured of a sea-going appointment after qualifying at **THE SCHOOL OF MARINE RADIO AND RADAR (A.S.T.),** Hamble, Southampton. For details apply Commandant, quoting A.12

VACANCIES FOR SKILLED CRAFTSMEN IN GOVERNMENT SERVICE AT CHELTENHAM

Experienced in one or more of the following:

1. Instrument Makers with fitting and machine shop experience in light engineering.
2. Maintenance of radio communication receivers.
3. Sub-assembly lay-out, wiring and testing of radio type chassis.
4. Cabling, wiring and adjustment of telephone type equipment.
5. Maintenance of teleprinters or cypher machines and associated telegraph equipment.
6. Fault finding in, and maintenance of, electronic apparatus.

BASIC PAY: £8 11s. 4d. plus up to £2 10s. merit pay, assessed at interview and based on ability and experience.

Opportunities for permanent and pensionable posts.

5-day week—good working conditions—single accommodation available.

Apply to:

Personnel Officer, G.C.H.Q.

(FOREIGN OFFICE),

53, Clarence Street, Cheltenham.

ASTRAL RADIO PRODUCTS

"HOME RADIO," 32 page illustrated booklet. Simple wiring instructions for Crystal Set, 1, 2, 3 Valves, 2/-, post 3d. **TRF COILS,** Specified for "Bedside Push-button 4." All Dry 3-Band, 3/- Push-button 4; etc. 6/6 pr. post 6d. Push-button Unit with modification data 7/-. **DUAL WAVE HF Coil,** Specified for "Summer All Dry Portable," Modern 1 Valve, "Modern 2 Valve," B7 G Battery Miniature, etc., 4/3, post 3d. **IFT'S Miniature,** 1 1/2" x 2 1/2" in cans. Extra high "Q." Special offer, 8/6 pr., post 6d. **K COILS,** "AC B" pass 3, 3/3 each, post 6d. **FRAME AERIALS,** M.W., 5/-, post 4d. **H.F. Choke (Osmer Q.C.I.),** 4/-, post 4d. **Crystal Set Coils, L & M.W.,** 2/6, post 3d.
82, Centurion Road, Brighton

ALL DISTRICTS

A Permanent and Increasing Income TECHNICAL AGENTS REQUIRED

For Servicing,

T.V. Insurance and T.V. Rentals

Must own Test Equipment.

Retailers' Enquiries Welcomed.

Write:

TELEPATROL LTD., WEST STREET, EPSOM.

Tel.: Epsum 4700.

BUILD YOUR OWN T/V and learn about its operation, maintenance and servicing. Qualified engineer-tutor available whilst you are learning and building. Free Brochure from **E.M.I. COLLEGE OF ELECTRONICS, Dept. PW58, London, W.4.** (Associated with H.M.V.)

RADIO AND ELECTRONICS Correspondence School. Easy postal courses in radio and electronics; our courses are specially prepared for the beginner; moderate fees. Syllabus free. Write **THE SECRETARY, Radio and Electronics Correspondence School, 68, Nina Drive, New Moston, Manchester, 10, Lanes.**

T/V AND RADIO.—A.M.Brit.I.R.E., City and Guilds, R.T.E.B. Cert., etc., on "no pass—no fee" terms. Over 95% successes. Details of exams, and home training courses in all branches of radio and T/V; write for 144-page handbook free. **B.I.E.T. (Dept. 242G),** 29, Wright's Lane, London, W.8.

A.M.I. Mech.E., A.M.Brit.I.R.E., City and Guilds, etc., on "no pass—no fee" terms; over 95% successes. For details of exams, and courses in all branches of engineering, building, etc., write for 144-page handbook, free. **B.I.E.T. (Dept. 242B),** 29, Wright's Lane, London, W.8.

WIRELESS. See the World as a Radio Officer in the Merchant Navy; short training period; low fees; scholarships, etc., available. Boarding and Day students. Stamp for prospectus. **WIRELESS COLLEGE, Colwyn Bay.**

WIRELESS. Day and Evening Class instruction for P.M.G. Certificate of Proficiency and Amateur Wireless Licence. Morse instruction only if required, also postal courses. Apply **BST. LTD.,** 179, Clapham Rd., London, S.W.9.

VALVES

New Tested and Guaranteed

1R5	7/6	6BA6	8/6	807	6/9
1S5	7/6	6BE7	8/6	ECH35	9/6
1T4	7/6	6K7	6/-	EP39	5/6
3V4	7/6	6K8	8/6	EF55	9/6
5Z4	8/6	6K8G	8/-	EF80	10/-
6AM6	7/6	6V8G	7/6	EK32	8/6
6AL5	6/6	12AT7	9/-	EL84	9/6
6AT6	9/6	12AU7	9/-	KT33C	7-9/6

MATCHED PAIRS, EL84, 23/- 6V6G, 17/-; 6BW6, 18/-; KT33C, 19/6; 807, 14/6 per pair.

VOLUME CONTROLS, small, long, spd., L/S, 3/-; S.P., 4/-; D.P., 4/6. All values

PAPER BLOCKS, 4 mfd., 1,000 v. wkg., 2/3. P & P 6d.

1-Finger Pianists

Build your own electronic keyboard and play everything! Send for free leaflet. Guitar, cello, flute and trumpet are all easy. Write now...

C & S, 10 Duke St., Darlington, Co. Durham

F M and H-FI Components

DENCO F.M. TUNER circuits 1s. 6d.
 RADIO CONST'N. F.M. " 2s. 0d.
 MULLARD AMPLIFIERS " 3s. 6d.
 OSRAM 912 PLIS " 4s. 0d.

Separate price lists available on request to **J. T. FILMER MAYPOLE ESTATE, BEXLEY, KENT.**

Tel. Bexleyheath 7267.

Solder with

LIFE SOL
 "PERMATIP"
 AND
 "PERMABIT"
 INSTRUMENTS
 FOR
 GREATER
 SOLDERING
 EFFICIENCY

The soldering bit which maintains its face indefinitely without attention. 25 models available for mains or low voltage supply. Bit sizes 3/32 to 3/8 inch. Full details in booklet S.P.10 from sole manufacturers :-

LIGHT SOLDERING DEVELOPMENTS LTD.,
 106, GEORGE STREET, CROYDON, SURREY. Tel. CR0ydon 8589.

VIEW MASTER BAND III CONVERSION

We can supply complete kits from stock for the converter described in "Practical Television."

Complete converter kit with new BVA Valves £9.4.0. (Credit terms: Deposit £1.6.9 and 7 monthly payments of £1.6.9.)

Complete converter kit with surplus valves, £8.2.0. (Credit Terms: Deposit £1.4.0 and 7 monthly payments of £1.4.0.)

Kit for conversion of the View Master Sound/Vision chassis, £2.0.0.

We can supply separate components and our fully detailed list is available on request.

WATTS RADIO

8 Apple Market, Kingston-on-Thames, SURREY

Telephone: KINGston 4099.

CERAMIC CAPACITORS

DISC.—Modern capacitors for decoupling uses. Midget, non-inductive, excellent insulation. Ideal for T.V. and V.H.F. 500 v. D.C. (300 v. A.C.) working:—470 pF, 0.001 µF, dia. 5/16in.; 0.002 µF, 0.003 µF, dia. 1/4in.; 0.005 µF, dia. 5/8in. Each 9d.

HI-K TUBULAR.—Similar dielectric and insulation to above. Midget tubular construction, 500 v. D.C. Working:—0.0005 µF, 0.001 µF, 0.0015 µF, 0.002 µF, 0.003 µF, 10µd. each; 0.005 µF, 0.01 µF, 1/- each.

NEGATIVE TEMPERATURE COEFFICIENT.—For tuned circuits where compensation is required: 3, 4.7, 6.8, 10, 15, 30, 50, 75, 100 pF. 1/- each.

Minimum postage 6d. on orders under £2.

SOUTHERN RADIO & ELECTRICAL SUPPLIES

SORAD WORKS, REDLYNCH SALISBURY, WILTS

Telephone: Downton 207

NORTHERN IRELAND UNI-CRAFT SUPPLIES

GF50 (Red) 3 for £1 or 7/- ea. Post Free.			
6E6	6 3	6AU6	8 6
6N7	5 6	6C4	5 6
6E7	5 6	6F3	9 3
6AK5	5 -	6SA7	7 6
6AG5	5 6	1T4	7 -
6BP5	7 6	50C5	9 -
6BR7	9 3	1T11	5 -
6CR6	6 6	185	7 -
6AG7	9 -	85A2	10 3
6BW7	11 -	6Y91	7 -
		12AT7	8 -
		12AU7	8 6
		12AX7	7 6
		6F40	10 -
		6CI30	10 -
		6CH42	9 -
		6DH77	8 -
		6LA2	11 9
		UC42	9 6
		EC91	6 6

* All Boxed and Guaranteed. Please allow a little Postage.

FULL RANGE OF TSL 1 WATT 10% RESISTORS STOCKED.

MIDGET BOXED 1 MEG. POTS.—Less Switch, 1 6 each.

Send for Free Lists of other Bargains, etc. 17 OLD LODGE RD., BELFAST, N.I.

THE T.S.L. F.M. TUNER for home construction using Gorker V.H.F. Unit and I.F.S. Full constructional details in Bernards No. 134 manual at 2/6 each. FULL PRICE-LIST in our complete list 6d. Post Paid.

T.S.L. ELECTROSTATIC LOUD-SPEAKERS (Tweeters), LSH75, 12/6 each. LSH518, 17/6 each. LSH100, 21/- each. Complete with instructions and circuits.

WE CARRY FULL STOCKS OF "BERNARD" AND "NORMAN PRICE" Publications. All post paid. See our list for details.

BAND III CONVERTERS.—CHANNEL C3, £10/10/0 each. GILLONE CONVERTER, £10/10/0 each. Post Paid.

AERIALX CO-AX CABLE for Band III, 10 1/2 d. per yard.

Send 6d. in stamps for our Complete Price List, everything for the engineer, home constructor, etc.

RADIO HAM SHACK LIMITED,

55, Swan Arcade, Bradford, 1

NEW BOOKS

T.V. Circuits and Service Data No. 1, by C. H. Banthorpe. 9 6. Postage 6d.

T.V. Timebase Circuits: Principles and Practice, by Banthorpe. 5 -. Postage 4d
 Radio Amateur's Handbook 1956, by A.R.R.L. 30-. Postage 1 3.

F.M. Tuner Units for Local Area Reception, by "Radio Constructor." 2 -. Postage 3d.

High-Fidelity: The Why and How for Amateurs, by G. A. Briggs. 12 6. Postage 1 -.

The 3rd Audio Anthology by Radio Magazines of America. 20 -. Postage 1 -.

Please write or call for lists.

UNIVERSAL BOOK CO.

12, Little Newport Street, London, W.C.2 (adjoining Lisle Street)

PARKER'S SHEET METAL FOLDING MACHINES

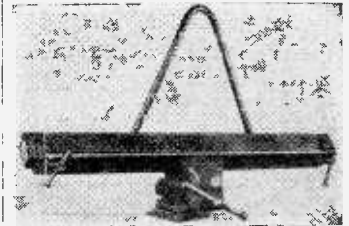

Heavy V-loc Models. 18 gauge mild steel 2 ft. wide and 16 gauge MS x 18 in. wide. Form angles and channels. End folding attachments for radio chassis. Tray or box making.

Price 55/- each. Attachments 1 6 per ft.

Carriage 4 -, if with attachments 5 6. Send for details of 3 ft. model, also sheet metal hack-saving machine.

A. B. PARKER WHEATCROFT WORKS
 WELLINGTON STREET, BATLEY, YORKS. Telephone 426

BROOKS (RADIO)

4 Charles Street, Morecambe, Lancs.

Tested—VALVES—Guaranteed

1A7	11 -	EBC41	10 6	EZ80	8 6
1C5	9 6	EBF80	10 -	PL82	9 6
1H5	9 6	ECC81	11 -	PL83	12 -
1N5	9 6	ECC82	11 -	PY80	9 6
6ATN	8 -	ECC83	11 -	PY81	10 -
6BA6	8 6	ECH42	11 -	PY82	9 -
6BE6	8 6	EF86	11 6	PY83	11 6
6X4	7 6	EL41	10 6	UBC41	9 6
6ABC80	10 -	EM34	10 6	UCH42	11 -
EAF12	10 -	EZ40	8 6	UF41	10 6

plus 6d. per valve p. & p.

PRICE REVISIONS

185, 1T4 now 7 -; 3Y4, 8 -; 6AM6, 8 6; 6V6, 7 6; 7Y4, 8 -; UL41, 10 6; UX41, 8 6. All other valves as advertised March issue.

LOFT-MOUNTING AERIALS (Band III). 3-element, 33 6; 5-element, 45 6.

All fixing and types Band II or III aerials stocked.

CROSSOVER UNITS (Band I & III), 11 6. CHANNEL Band III Convertors, 10 6.

Speaker Fret at old prices. Electricians' Tool sets. Send for price list.

TELETRON SUPER INDUCTOR COILS



FERRITE ROD AERIALS

Wound on high permeability Ferroxcube rod. MW.89. Dual wave, 12/9.

BAND III CONVERTER COILSET 15/-, Wiring diagram, circuit and constructional information 3d. (free with coilsets). Selective Crystal diode coil. Type HAX. 3 -. For tape and quality amplifiers. Dual wave I.R.F. Coils, matched p.s., 7 -. Transistor coils, I.F.'s etc., available from leading stockists. Stamp for complete list and circuits.

THE TELETRON CO. LTD.

266, Nightingale Road, London, N.9 HOW 2527

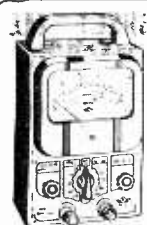

PULLIN
SERIES 100
TEST METER
AC/DC 10,000 Ω/V
21 RANGES
100 μ A to 1000V
COMPLETE IN ONE UNIT
CARTE WITH TEST LEADS
CLIPS AND TAGES
FULLY GUARANTEED

SENT POST FREE FOR **£2.10s.** DEPOSIT AND NINE FURTHER MONTHLY PAYMENTS OF £14.6. CASH PRICE £127.5.0.

FRITH RADIOCRAFT LTD

69 21 CHURCHGATE
LEICESTER
PHONE 5897



28 HIGH STREET
NEWPORT GACCELL,
BUCKS PHONE 237

SPARKS' DATA SHEETS

Constructional Sheets of Guaranteed and Tested Radio Designs.

Battery operated.
LO/25. 1-V. M.L. Waves. Fine Phone Sigs.
LO/26. 1-V. Med/Wave Portable.
LO/31. 2-V. M.L. Portable Fine Range.
LO/30. 2-V. M.L. Most Widely Praised
LO/35. 4-V. M.L. T.R.F. Range and Power.
LO/27. 4-V. All-wave S.Het. Compact.
D.X.2. 2-V. Sport-wayer. Really Good.
Data Sheets, etc., for above, 3/- each, post free.

MCLEARD 510 AMPLIFIER
The Sparks' version, with Separate Control Unit, is noted for its simplicity and efficiency: D Sheet, etc., 3/6.
MANY OTHER DESIGNS AVAILABLE.
SEND 2hd. STAMP FOR DETAILED LIST.
All Components & Chassis Available.

L. ORMOND SPARKS (P),
Valley Road, Corfe Castle, Dorset

Broadcast in Your Own Home



The New Highly Sensitive Microphone incorporating a specially wound transformer designed to match any Radio or Radiogram, mains or battery. Hours of amusement at a party, good fun for all the family. Suitable for baby alarms and many other purposes. Not a toy but a guaranteed working instrument. Full instructions enclosed. Made to sell at 21/-.

OUR PRICE **15/-** POST FREE.
Trade supplied
E. CLAPSHAW
369, Alexandra Rd., Muswell Hill, London, N.10.

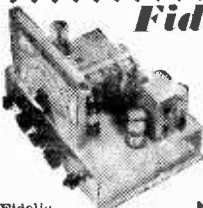

Fidelia
HAND BUILT RADIO UNITS

THE **FIDELIA** MAJOR 10
AM/PM models give reception of V.H.F. high quality transmissions plus normal wavebands. Major AM/PM 12 valves, £44. Detune AM/PM 11 valves, £33/12/- F.M. Tuner, £14/3/- Data sheets free. Electro Acoustic Developments, 2, Amburst Road, Telscombe Cliffs, Sussex.

INTERNATIONAL TUBE Handbook 15/- Post 9d.
(MK BUIZEN)

- THE RADIO AMATEUR'S HANDBOOK, 1956.** By A. R. R. L. 30s. 0d. Postage 1s. 6d.
- MAGNETIC RECORDING HANDBOOK.** By R. E. B. Hickman. 21s. 0d. Postage 1s. 0d.
- PHOTO-ELECTRIC HANDBOOK** By G. A. G. Ive. 17s. 6d. Postage 1s. 0d.
- SECOND THOUGHTS ON RADIO THEORY.** By "Cathode Ray." 25s. 0d. Postage 1s. 0d.
- THE A.R.R.L. ANTENNA BOOK.** 18s. 0d. Postage 1s. 0d.
- A BEGINNER'S GUIDE TO RADIO.** By F. J. Camm. 7s. 6d. Postage 6d.
- TELE-COMMUNICATIONS PRINCIPLES.** By R. N. Renton. 45s. 0d. Postage 1s. 3d.

The MODERN BOOK CO.

BRITAIN'S LARGEST STOCKISTS of British and American Books
19-23, PRAED ST., LONDON, W.2
Phone : PADDington 4185
Open 6 days 9-6 p.m.
1956 Catalogue Free on Request

2 K Wirewound Pots, New and boxed. 1/- each, 10/- doz.
1 H.P. Motors. Few only left. New. Frustrated export. Ball bearings, 1,425 r.p.m. Split phase. 230 volt A.C. 97.6 carriage paid.
Sound Power Telephones, Ex. Admity. As advertised 57.6 each. Guaranteed. Our price 19.6. Post & pack. 3.6.
15 ohm Pressure type Speaker Units. 15/- Post & pack. 2.6.
Single Screened Cable, 9d. yd. Twin 1-yd. Post paid.
Chiton Overload Relays. 15, 30 and 50 amp. 5.6 each. Post paid.
12in. P.M. Speakers. 27.6. Post & pack. 2.6.
G.P.O. type Handsets. 8.6. Post & pack. 1.6.
24 volt Generators. 9 amp. 65-. Carriage & pack. 5.7.
Heat-controlled Domestic Irons by well-known maker. 450 watts. 25/- each. Post & pack. 2.6.
Wireless Remote Control Unit "F". New in metal box comprising quantity of useful items including morse key, telephone generator, terminals, key switch, G.P.O. type relay, phone jack sockets, bell, condensers and sundry other items. 36.6. Carriage & pack. 3.6.
Money back guarantee on everything.
When in Exeter call and see our large stocks.

ELECTROSURP
120 Fore Street, Exeter
Phone Exeter 56687

RADIO AND TELEVISION COMPONENTS
All parts in stock for:
Viewmaster, Soundmaster, Teleking, etc.
Easy Terms available.
2hd. stamp (only) for Catalogue.
JAMES H. MARTIN & CO.,
FINSTHWATE, NEWBY BRIDGE
ULVERSTON, LANCs.

RECORD PLAYERS!
AMPLIFIED PLAYERS!
GRAM MOTORS!
AUTO-CHANGERS!
CABINETS!
Many to be cleared at less than half price.
3-speed Gram. Motors by well-known manufacturer. 100 125, 200 250 AC mains. 33, 45, 78 r.p.m. and neutral by selector switch. 7 guinea value! Our price £3.10.0.
3-speed Record Players, fitted Accos turn-over HCP 59 pick-ups, with twin sapphire styl. Rexine case with lid, fitted clasps and handle. Worth 10 gns. Our price £7.15.6.
Carriage, Packing & Insurance, 5.6.
Send stamp for complete brochure lists.
RONALD WILSON & CO.
(Dept. P.W.) 12, Bridge St., Worcester

TRANSFORMERS FOR WELL-KNOWN AMPLIFIERS

Mullard 3W, MT/3m (mains)	35/-
OT/3 (output)	21/-
5-10 OT/6 (output)	45/-
MT/5/10 (mains)	36/-
Osram 912 MT/912 (mains)	40/6
OT/912 (output)	45/-

The above are of ELSTONE Make
Trade supplied:

KENDALL & MOUSLEY LTD.
18, Melville Road, Birmingham, 16

H.A.C. SHORT WAVE EQUIPMENT

Noted for over 18 years for S.W. Receivers and Kits of Quality.
Improved designs with Denco coils:
One-Valve Kit, Model "C" Price, 25/-
Two "E" " " " " " " " " 50/-
All kits complete with all components, accessories, and full instructions. Before ordering call and inspect a demonstration receiver, or send stamped, addressed envelope for descriptive catalogue.
"H.A.C." SHORT-WAVE PRODUCTS (Dept. TH), 11, Old Bond Street, London, W.1.

TELEVISION

The advance of Radio Technique will offer unlimited opportunities of high pay and secure posts for those Radio Engineers who have had the foresight to become technically qualified. How you can do this quickly and easily in your spare time is fully explained in our unique handbook.
Full details are given of A.M. Brit. I.R.E., City & Guilds Exams., and particulars of up-to-date courses in Wireless Engineering, Radio Servicing, Short Waves, Television, Mathematics, etc., etc. We guarantee "NO PASS - NO FEE." Prepare for to-morrow's opportunities and future competition by sending for this very informative 144-page guide NOW - FREE and without obligation.
BRITISH INSTITUTE OF ENGINEERING TECHNOLOGY
(Dept. 242), COLLEGE HOUSE, 28-31, Wright's Lane, Kensington, W.8

ASPDEN TAPE DECKS

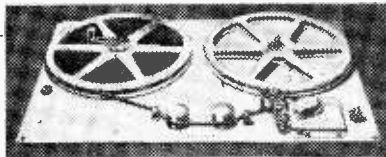

Two speed Twin Track.

Compact Deck, Model 521, 7½ in. x 11 in. 5 in. reels.
KIT, £7.10.0.

Standard Deck, Model 721, 10½ in. x 15 in. 7 in. reels.
KIT, £8.10.0.

Precision machined parts, easy to assemble with full assembly instructions and drawings. High Quality Ferroxcube Heads. Finest motor.
Either deck fully built and tested, 27/6 extra.

NEW AMPLIFIER KIT

Record/replay—2½ watts output—Neon Level indicator—2 recording positions.

Kit without valves, £5.18.0.

Power Pack Kit for above, without valve, £2.18.6.
Carriage extra.

Send stamp for full details to :

W. S. ASPDEN 10, Market St., Wesham
KIRKHAM, LANCs

REPANCO HIGH GAIN SUPERHET COIL PACK

TYPE LMS

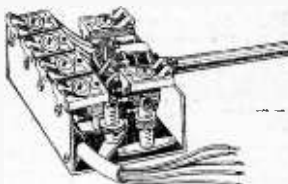

Size 2½ x 2¾ x 1½ in.
Long Wave 900-2,000 m.
Medium Wave 190-550 m. Inc. Tax
Short Wave 16-60 m. Complete with 5-valve
Aligned before Despatch. Superhet Wiring Diagrams

36/-

Send S.A.E. for Catalogue of Complete Range of Coils.

REPANCO HIGH-GAIN LOW-NOISE BAND III CONVERTER

Self-contained Power Supply. Easy to Build. Envelope of comprehensive wiring plans and instructions, 1/9 (post free).

RADIO EXPERIMENTAL PRODUCTS LTD.

33 MUCH PARK STREET, COVENTRY

Phone : 62572

Train for a wonderful future in—

ELECTRONICS

Train to meet the need for pioneers—in this expanding field.

Every day the demand for the expert in electronics grows. Radio, television, radar and the whole field of industrial automation are rapidly expanding, and the trained specialist assures for himself a well-paid career in this quickly developing profession. Here is your opportunity to enter for

1-year course

Full-time day course in the Principles and Practice of Radio and Television. Mainly designed for the training of Radio and Television Servicing Engineers. Next course, commencing May 22nd, is already fully booked. Enrolments for following course, commencing September 11th, now being accepted.

The E.M.I. College of Electronics

Dept. 32, 10, Pembridge Square, London, W.2.

Telephone : BAYswater 5131/2

The College associated with a world-wide electronics industry, including "His Master's Voice," Marconiphone, Columbia, etc.

COMMUNICATIONS RECEIVER R.1155.—The famous Bomber Command Set. Covers 18.5-7.5 Mc s. 7.5-3.0 Mc s. 1,500-600 kc s. 500-200 kc s. 200-75 kc s. BRAND NEW IN MAKERS' TRANSIT CASES. ONLY £11.19.6. Used models £5.19.6. or with super slow-motion tuning £6.19.6. ALL types tested working before despatch, and supplied with 14-page booklet which gives technical information, circuits, etc. (available separately 1/3).

A.C. MAINS POWER PACK OUTPUT STAGE. in black metal case. Enables receiver to be operated immediately by just plugging in. Supplied WITH built-in speaker £5.5.0. or LESS speaker £4.10.0.

DEDUCT 10/- IF PURCHASING RECEIVER & POWER PACK TOGETHER.
Add carriage costs of 10/6 for receiver. 5/- for power pack.

AMERICAN "COMMAND" RECEIVERS.—Huge purchase from the Air Ministry. These famous compact receivers which can be used for a variety of purposes are offered at ridiculously low prices while stocks last. Complete with 6 metal type valves. 1 each of 12K8, 12SR7, 12A6, and 3 of 12SJ7, in aluminium case size 11" x 6½" x 5". Used, but in very good condition, although cases may be somewhat dented. First come, first served. Choice of models. BC455 (6-9 mcs), 25/-, BC454 (3-6 mcs), 27/6, BC453 (190-550 kcs, the renowned "Q" Fiver), 59/6, and a few of the 1.5-3.0 mcs. model 65 -. (Carriage, etc., 3/-)

COLLINS TCS TRANSMITTERS.—Special offer of these famous American Transmitters. Frequency range 1.5-12.0 mcs in 3 bands. Employs 7 valves, 2 of 12S7 in P.A. Stage, 1625 buffer and 1925 modulator Stage, 3 of 12A6 in oscillator stage. Radio telephone or radio telegraph. Provision for Frequency Control. 4 crystal positions. Has plug-in for different meters. In BRAND NEW CONDITION ONLY £12.10.0. (Matching receivers available £8.10.0. or THE TALK 200. (Carriage 10/- each.)

RECEIVER 25 73.—Part of the TR.1196, this makes an ideal basis for a mains operated all wave superhet. full modification data being supplied. Complete with valves 2 each EF86 and EF39, and 1 each EK32 and EBC33. BRAND NEW. ONLY 27/6 (post, etc., 3/-)

TR.1198 TRANSMITTER SECTION. complete with valves EF50, EL32, CV501, and all components. BRAND NEW. ONLY 12/6 (post, etc., 3/-).

(Amounts given for carriage refer to inland only.)

U.E.I. CORPORATION 138, Gray's Inn Road, London, W.C.1 (Phone: TERNminus 7937)

Open until 1 p.m. Saturdays. We are 2 mins. from High Holborn (Chancery Lane Station), and 5 mins. by bus from King's Cross.

Practical Wireless

BLUEPRINT SERVICE

PRACTICAL WIRELESS

	<i>No. of Blueprint</i>
CRYSTAL SETS	

1/6d. each	
1937 Crystal Receiver ...	PW71*
The "Junior" Crystal Set ...	PW94*
2s. each	
Dual-Wave "Crystal Diode" ...	PW95*

STRAIGHT SETS

Battery Operated.

One-valve : 2s. each	
The "Pyramid" One-valver (HF Pen) ...	PW93*
The Modern One-valver ...	PW96*

Two-valve : 2s. each	
The Signet Two (D & LF) ...	PW76*

3s. each	
Modern Two-valver (two band receiver) ...	PW98*

Three-valve : 2s. each	
Summit Three (HF Pen, D, Pen) ...	PW37*

The "Rapid" Straight 3 (D, 2 LF (RC & Trans)) ...	PW82*
---	-------

F. J. Camm's "Sprite" Three (HF, Pen, D, Tel) ...	PW87*
---	-------

3s. each	
The All-dry Three ...	PW97*

Four-valve : 2s. each.	
Fury Four Super (SG, SG, D, Pen) ...	PW34C*

Mains Operated

Two-valve : 2s. each.	
Selectone A.C. Radiogram Two (D, Pow) ...	PW19*

Three-valve : 3s. 6d. each.	
A.C. Band-Pass 3 ...	PW99*

Four-valve : 2s. each.	
A.C. Fury Four (SG, SG, D, Pen) ...	PW20*

A.C. Hall-Mark (HF Pen, D, Push Pull) ...	PW45*
---	-------

SUPERHETS

Battery Sets : 2s. each.	
F. J. Camm's 2-valve Superhet ...	PW52*

Mains Operated : 3s. 6d. each.	
"Coronet" A.C.4 ...	PW100*
AC/DC "Coronet" Four ...	PW101*

*No. of
Blueprint*

SHORT-WAVE SETS

Battery Operated.

One-valve : 2s. each.	
Simple S.W. One-valver ...	PW88*

Two-valve : 2s. each.	
Midget Short-wave Two (D, Pen) ...	PW38A*

Three-valve : 2s. each.	
Experimenter's Short-wave Three (SG, D, Pow) ...	PW30A*

The Perfect 3 (D, 2 LF (RC and Trans)) ...	PW63*
--	-------

The Band-spread S.W. Three (HF, Pen, D, (Pen), Pen) ...	PW68*
---	-------

PORTABLES

1s. 6d.	
The "Mini-Four" All-dry (4-valve superhet) ...	*

MISCELLANEOUS

2s. each.	
S.W. Converter-Adapter (1 valve) ...	PW48A*

The P.W. 3-speed Autogram ... (2 sheets), 7s. 6d.*	
The P.W. Electronic Organ (2 sheets), 7s. 6d.	*

TELEVISION

The "Argus" (6in. C.R. Tube), 2/6*	
The "Super-Visor" (3 sheets), 7/6*	
The "Simplex" ... 3/-*	
The P.T. Band III Converter 1/-*	

All the following blueprints, as well as the PRACTICAL WIRELESS numbers below 94 are pre-war designs, kept in circulation for those amateurs who wish to utilize old components which they may have in their spares but. The majority of the components for these receivers are no longer stocked by retailers.

AMATEUR WIRELESS AND WIRELESS MAGAZINE

STRAIGHT SETS

Battery Operated.

One-valve : 2s.	
B.B.C. Special One-valver ...	AW387*

Mains Operated

Two-valve : 2s. each.	
Consoelectric Two (D, Pen), A.C. ...	AW403

SPECIAL NOTE

THESE blueprints are drawn full size. The issues containing descriptions of these sets are now out of print, but an asterisk denotes that constructional details are available, free with the blueprint.

The index letters which precede the Blueprint Number indicate the periodical in which the description appears. Thus P.W. refers to PRACTICAL WIRELESS, A.W. to *Amateur Wireless*, W.M. to *Wireless Magazine*.

Send (preferably) a postal order to cover the cost of the Blueprint (stamps over 10d. unacceptable) to PRACTICAL WIRELESS, Blueprint Dept., George Newnes, Ltd., Tower House, Southampton Street, Strand, W.C.2.

*No. of
Blueprint*

SHORT-WAVE SETS

Battery Operated

One-valve : 2s. each.	
S.W. One-valver for American ...	AW429*

Two-valve : 2s. each.	
Ultra-short Battery Two (SG, det Pen) ...	WM402*

Four-valve : 3s. each.	
A.W. Short Wave World-beater (HF Pen, D, RC, Trans) ...	AW436*

Standard Four-valver Short-waver (SG, D, LF, P) ...	WM383*
---	--------

Mains Operated

Four-valve : 3s.	
Standard Four-valve A.C. Short-waver (SG, D, RC, Trans) ...	WM391*

MISCELLANEOUS

Enthusiast's Power Amplifier (10 Watts) (3/-)	WM387*
---	--------

Listener's 5-watt A.C. Amplifier (3/-)	WM392*
--	--------

De Luxe Concert A.C. Electrogram (2/-)	WM403*
--	--------

QUERY COUPON

This coupon is available until July 6th, 1956 and must accompany all Queries, sent in accord with the notice on our "Open to Discussion" page. PRACTICAL WIRELESS, July, 1956.



G.E.C.

ALUMINISED C.R. TUBES

for tube replacements

7203A 14"

The G.E.C. 14 in. Cathode Ray Tube type 7203A has the following attractive features:—

1) Improved tube life and reliability.

2) A narrow beam angle *triode* gun giving:—

- (a) Uniform focus over the entire screen area.
- (b) Small spot size.
- (c) Freedom from astigmatism.

3) A high reflectance aluminium backing to the fluorescent screen giving:—

- (a) 70% increase in picture brightness.
- (b) High contrast daylight viewing.
- (c) Complete elimination of ion burn from both positive and negative ions.

Price £14. 15. 0

P. Tax £6. 18. 1