

• Making a Car Radio •

# PRACTICAL WIRELESS

NOVEMBER  
1955

EDITOR: E. J. CANN

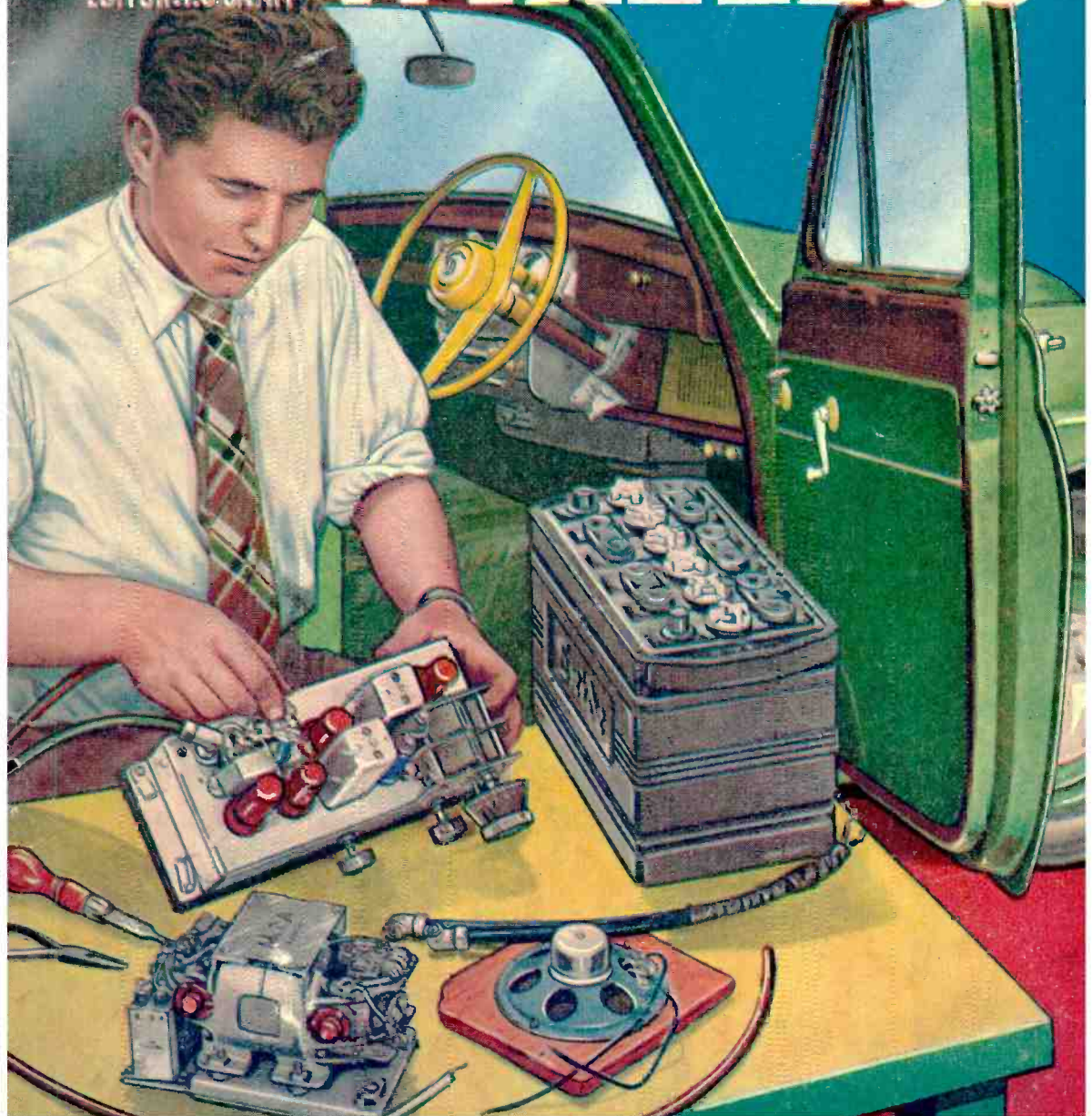

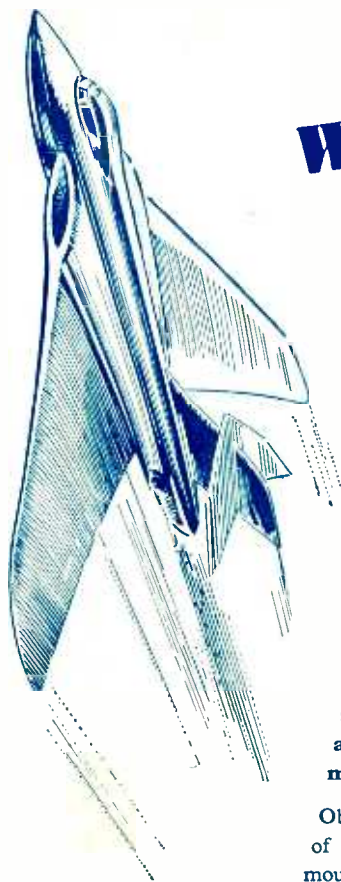

# What's all this about Hi-g?

"g" is the symbol for acceleration which, to the technical, is defined as the differential of velocity with respect to time. More simply this means the rate of change of speed.

When "g" is too great, damage will be done. A locomotive leaves the rails when it takes a curve too fast. At only 6 "g" a pilot blacks out when he pulls out of a dive; at 20 "g", which is very much more than any plane can possibly encounter, the plane would disintegrate.

The stylus tip of a pick-up is subjected to the same acceleration but to an infinitely greater extent. The undulations of a record groove cause the stylus to vibrate as much as 10,000 times per second or more. It moves to one side of the groove, stops, moves to the other, stops again and so on throughout the record. **The accelerations acting upon the stylus tip are measured in "g" and with modern recordings may be well over 1000 "g".**

Obviously a light freely suspended stylus will follow rapid changes of direction in record grooves more easily than a heavy, stiffly mounted one. On a heavily recorded record a "stiff" pick-up will tear through record grooves or even jump right out of them. Result: rapid record and stylus wear and poor reproduction.

Correct tracking of modern electrical recordings with their great musical and dynamic range calls for pick-ups specially designed to cope with very high "g". They are available, after much patient research and development, under the name "Hi-g". **ACOS "Hi-g" pick-ups perform perfectly at any multiple of "g" they are called upon to meet,** representing a truly revolutionary advance in pick-up design. If you want your valuable records to reproduce as well as the makers intended—and to go on doing so for a long time — use an "ACOS Hi-g" pick-up.

*(Write for a free copy of the new Cosmocord booklet "The ABC of Hi-g".)*



**... always well ahead**



*ACOS devices are protected by patents, patent applications and registered designs in Great Britain and abroad.*

**COSMOCORD LIMITED • ENFIELD • MDDX • Tel: ENField 4022**



# !!HOME CONSTRUCTORS!!

You can assemble the *Stern's Fidelity* Tape Recorder for only £40  
**!!!IT ONLY NEEDS CONNECTING UP!!!**

This 2-speed Twin Track Recorder although supplied at a Genuinely Low Price, provides absolute Fidelity Recordings, and in addition to being completely dependable has a performance at least equal to Recorders marketed at a far higher price. The actual assembly of the Recorder is simple, and only involves a few connections. The Truvox Tape Deck and the Quality Amplifier are supplied tested and ready for use, and all that is required to complete the Recorder is to connect the two together (a connection chart is supplied for this purpose) and secure them by the screws provided into the Attache Case. The items illustrated and described below form the complete equipment.



**SEND S.A.E. FOR DESCRIPTIVE LEAFLET INCLUDING PRICE DETAILS & H.P. TERMS**

### TRUVOX TAPE DECK MODEL Mk. III/TR7u

This is Truvox's new "small" design being only 14in. x 10in. The whole instrument is built to close engineering limits resulting in the minimum of "wow" and "flutter" values. It will play the NEW PRE-RECORDED TAPES and takes all standard tapes up to 1,200ft.

PRE-RECORDED TAPES and takes all standard tapes up to 1,200ft.

**SCOTSBY MAGNETIC RECORDING TAPE**  
 Supplied complete with a 1,200ft. reel of Scotsboy Tape. In addition, the Recorder will take all standard makes of tapes.

### PORTABLE ATTACHE CASE

This, as may be judged from the illustration above, is a neat, compact and attractively finished case, being covered with maroon rexine and having an ivory coloured speaker escutcheon. It contains concealed pockets to accommodate the Microphone, Mains Lead and a spare 1,200ft. reel of tape.

### MODEL TRF QUALITY AMPLIFIER

This amplifier has been expressly designed to meet the requirements of reproduction, and in particular to CORRECTLY operate the above TRUVOX DECK. It is supplied complete with a matched Elliptical 3 ohm P.M. Speaker. It incorporates an efficient Tone Control arrangement and has a Magic Eye Level Indicator (Operative on Record). It can also be used as a general purpose Amplifier for high quality reproduction of gramophone records direct from a Gram Unit.

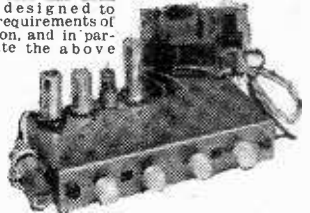

It can be supplied complete and ready for use for £43. H.P. Terms available.

**MODEL MIC33/1 CRYSTAL MICROPHONE**  
 A highly sensitive Mike which accurately matches the input arrangement of the Amplifier.

## STERN RADIO LTD.

109 & 115, FLEET STEET, E.C.4  
 Tel.: CENTRAL 5812-3-4.

**Osram nine one two**

*the most successful amplifier design*

**now...**

**Osram**

**nine-one-two PLUS**

**Six position fully screened Selector Switch, with or without pre-amplifier, to cater for all types of record, various types of pick-up, radio and microphone inputs.**

This book gives details of how to modernise this popular Amplifier. Stage by stage wiring instructions are included for the improved '912', and there are many additional valuable features. By purchasing this book, you can read how to bring up-to-date your existing Osram '912' or obtain full details for constructing this versatile and remarkable Amplifier for High Quality Sound Reproduction. It costs 4s. 0d. from your dealer or by post 3d. extra from Osram Valve & Electronics Dept.

THE GENERAL ELECTRIC CO. LTD., MAGNET HOUSE, KINGSWAY, LONDON, W.C.2.

# PREMIER RADIO COMPANY

B. H. MORRIS & CO., (RADIO) LTD.

OPEN TILL 6 P.M. SATURDAYS (Dept. P.W.) 207, EDGWARE ROAD, LONDON, W.2

Telephone: AMBASSADOR 4033 PADDINGTON 3271-2

## BUILD THESE NEW PREMIER DESIGNS

**3-BAND SUPERHET RECEIVER**  
MAY BE BUILT FOR **£7.19.6** Plus 2/6 Pk. & Carr.

Latest type Superhet Circuit using 4 valves and metal rectifiers for operation on 200/250 volts A.C. mains. Waveband coverage — short 10-50 metres, medium 180-550 metres, and long 500-1,000 metres. Valve line-up 6SK7 freq. changer, 6K7, 1F, 6U7, Detector AVC and first AF, 6V6 output. The attractive cabinet to house the Receiver size 12in. long, 6 1/2in. high, 5 1/2in. deep can be applied in either WALNUT or IVORY BAKELITE or WOOD. **INSTRUCTION BOOKS** 1/- each, (post and wiring diagrams, also a detailed Stock



**TRF RECEIVER**  
MAY BE BUILT FOR **£5.15.0** Plus 2/6 Pk. & Carr.

The circuit is the latest type TRF using 3 valves and Metal Rectifiers for operation on 200/250 A.C. mains. Wave band coverage is 190/550 metres on medium wave and 100/2,000 metres on long wave. The dial is illuminated and the Valve line-up is 6K7 H.F. Pentode w/ Detector and 6V6—Output. **Free** which includes Assembly and wiring diagrams, also a detailed Stock List of priced components.

**4-WATT AMPLIFIER**

MAY BE BUILT FOR **£4.10.0** Plus 2/6 Pk. & Carr.

Valve line-up 6SL7, 6V6 and 6X5. FOR A.C. MAINS 200/250 VOLTS. Suitable for either 3-ohm or 15-ohm Speakers. Negative feedback. Any type of pick-up may be used. Overall size 3 x 7 x 3in. Price of Amplifier complete, tested and ready for use, £5.5.0 plus 3/6 pkg. and carr.



### CABINETS—PORTABLE

**Model PC/1**  
Brown Rexine covered, 15 1/2in. Overall dimensions 15in. x 13 1/2in. x 5in. Clearance under lid when closed 2 1/2in.  
**Model PC/2**  
Grey Lizard Rexine covered, 4 1/2in. Overall dimensions 15in. x 13in. x 6in. Clearance under lid when closed 3in.  
**Model PC/3**  
Rexine type covering in various colours, 6 3/8in. Overall dimensions 10 1/2in. x 14 1/2in. x 1 1/2in. Clearance under lid when closed 6 1/2in. All the above Cabinets are supplied with Panel, Carrying Handle and Clips. Packing and Postage 2/-.  
Send for details of the Premier Wide angle Television design which may be built for £30.

### ALL-DRY BATTERY PORTABLE RADIO RECEIVER

4 miniature Valves in a Superhet Circuit covering medium and long waves. Rexine covered Cabinets 11 1/2in. x 10in. x 5 1/2in. in two contrasting colours. Wins with Grey Panel, or Blue with Grey Panel, please state choice when ordering. The SET MAY BE USED EVERYWHERE—home, office, car or holidays. **INSTRUCTION BOOK, 1/6** (Post free) which includes Assembly and wiring diagrams, also a detailed Stock List of priced components

MAY BE BUILT FOR **£7.8.0** Plus 2/6 Pk. & Carr.



**DECCA MODEL 37A DUAL SPEED RECORD PLAYER** includes turn over crystal pick-up with sapphire stylus and a light-weight, plastic, spring-balanced arm. Heavy gauge pressed steel case with brown enamel finish in good quality for operation on A.C. mains 200/250 v. 50 c.p.s. Supplied complete, £3.13.5. Plus pkt. and carr. 5/-. **★SEND 2 1/2d. STAMP FOR OUR 1955 CATALOGUE.**

# NEW!

## THE PRACTICAL WAY of learning RADIO · TELEVISION · ELECTRONICS

Power Supply unit

2-stage receiver

3-stage T.R.F. Receiver

Special units

Complete 5 valve Superhet 3-wave band receiver suitable for A.M. or F.M. reception

Instructional lesson manuals

NEW TELEVISION COURSE including a complete set of equipment dealing with the design, construction and servicing of a high quality television receiver.

COURSES FROM 15/- PER MONTH

### EMI INSTITUTES

An educational organisation serving the E.M.I. Group of Companies which include "His Master's Voice," Marconiophone, Columbia, etc.

SEND COUPON FOR FREE PROSPECTUS

To E.M.I. Institutes,  
Dept. 32X, Grove Park Road, London, W.4.  
Please send me your FREE book on Practical Courses

Name \_\_\_\_\_

Address \_\_\_\_\_

November \_\_\_\_\_ IC.68



# VALVES—GUARANTEED NEW AND BOXED

6Z5	8/6	6F14	12/6	6V6/GT	7/8	10P13	11/6	25Z5	9/-	EZ40	10/-	PCF82	12/6	VR85	7/6
5Z4g	8/6	6G6G	6/-	6X4	8/-	10P14	11/6	25Z6GT	8/6	EZ41	11/-	PL81	13/6	VR86	6/-
6A7	10/8	6H6	3/6	6X5/GT	7/8	12A6	6/9	35L6GT	8/9	EZ80	10/6	PL82	11/6	VR87	8/-
6AR5/GT	10/8	6J5/GT	5/-	7B6	10/-	12A7	6/9	35W4	10/6	E1148	2/-	PL83	13/-	VR85	3/6
6AC7	6/6	6J5M	6/6	7B7	8/8	12A7	9/-	35Z4GT	8/8	PW4500	10/-	PL225	5/-	VR65A	3/6
6AK5	6/6	6J6	7/6	7C5	8/6	12A7	9/-	5016GT	9/-	G32	12/6	PY80	10/6	VR86	3/6
6AK5	6/6	6J7	6/6	7C6	8/6	12AX7	10/-	AC/P	6/9	H30	5/-	PY81	11/6	VR91	5/6
6AL5	7/-	6K6GT	8/6	7H7	8/-	12BE6	10/-	AC/PEN	5/6	H12	5/6	PY82	10/6	VR181YL	7/-
6AM5	5/-	6K74/GT	5/9	7J7	8/-	12C8	8/-	ATP4	6/8	HL23D1D	7/6	QP21	7/6	VR92	2/6
6AM9	7/6	6K8	6/9	7K7	8/6	12C6	8/6	H73M	10/-	HP211C	6/9	S222	6/-	VR105/20	9/-
6AQ5	8/6	6K8G	8/6	787	8/8	12J5	6/-	EA4E2	12/6	KL55	8/6	SP26	6/-	VR119	4/-
6AT6	8/-	6K8GT	9/6	7Y4	8/6	12J7	9/6	EB41	8/6	KT2	5/-	SR92	6/-	VR119	4/-
6B4	5/-	6L1	17/6	75	10/8	12K7	9/-	EB41	11/6	KT33C	10/6	U16	9/-	VR123	6/6
6B4	8/6	6L16G	9/-	77	8/-	12K8	11/-	EB89	11/6	KT66	10/6	U22	8/-	VR126	7/6
6B4G	8/6	6L17M	7/6	80	8/6	12Q7	7/6	EC35	12/6	KT74	8/-	U25	13/6	VR137	5/6
6B6	11/6	6L18	7/6	807	8/6	12R6	7/6	EC42	10/6	KTW61	7/6	U229	13/6	VR150/30	9/-
6B6	10/6	6L19	7/6	807	8/6	12R6	7/6	EC42	10/6	KTW63	8/6	V125	10/-	VR16	8/-
6B7	7/6	6L20	8/6	812	2/9	12R7	7/6	EC42	10/6	KTZ11	6/6	U404	9/-	V870	3/6
6B7	7/6	6L21	8/6	812	3/9	12R7	5/6	ECL80	11/6	KTZ11	6/6	U404	9/-	V870	3/6
6B7	7/6	6L22	8/6	812	3/9	12R7	5/6	EF22	8/6	LP220	6/6	U6	10/-	VT52	8/6
6B7	7/6	6L23	8/6	812	3/9	12R7	5/6	EF22	8/6	LP220	6/6	U6	10/-	VT52	8/6
6B7	7/6	6L24	8/6	812	3/9	12R7	5/6	EF22	8/6	LP220	6/6	U6	10/-	VT52	8/6
6B7	7/6	6L25	8/6	812	3/9	12R7	5/6	EF22	8/6	LP220	6/6	U6	10/-	VT52	8/6
6B7	7/6	6L26	8/6	812	3/9	12R7	5/6	EF22	8/6	LP220	6/6	U6	10/-	VT52	8/6
6B7	7/6	6L27	8/6	812	3/9	12R7	5/6	EF22	8/6	LP220	6/6	U6	10/-	VT52	8/6
6B7	7/6	6L28	8/6	812	3/9	12R7	5/6	EF22	8/6	LP220	6/6	U6	10/-	VT52	8/6
6B7	7/6	6L29	8/6	812	3/9	12R7	5/6	EF22	8/6	LP220	6/6	U6	10/-	VT52	8/6
6B7	7/6	6L30	8/6	812	3/9	12R7	5/6	EF22	8/6	LP220	6/6	U6	10/-	VT52	8/6
6B7	7/6	6L31	8/6	812	3/9	12R7	5/6	EF22	8/6	LP220	6/6	U6	10/-	VT52	8/6
6B7	7/6	6L32	8/6	812	3/9	12R7	5/6	EF22	8/6	LP220	6/6	U6	10/-	VT52	8/6
6B7	7/6	6L33	8/6	812	3/9	12R7	5/6	EF22	8/6	LP220	6/6	U6	10/-	VT52	8/6
6B7	7/6	6L34	8/6	812	3/9	12R7	5/6	EF22	8/6	LP220	6/6	U6	10/-	VT52	8/6
6B7	7/6	6L35	8/6	812	3/9	12R7	5/6	EF22	8/6	LP220	6/6	U6	10/-	VT52	8/6
6B7	7/6	6L36	8/6	812	3/9	12R7	5/6	EF22	8/6	LP220	6/6	U6	10/-	VT52	8/6
6B7	7/6	6L37	8/6	812	3/9	12R7	5/6	EF22	8/6	LP220	6/6	U6	10/-	VT52	8/6
6B7	7/6	6L38	8/6	812	3/9	12R7	5/6	EF22	8/6	LP220	6/6	U6	10/-	VT52	8/6
6B7	7/6	6L39	8/6	812	3/9	12R7	5/6	EF22	8/6	LP220	6/6	U6	10/-	VT52	8/6
6B7	7/6	6L40	8/6	812	3/9	12R7	5/6	EF22	8/6	LP220	6/6	U6	10/-	VT52	8/6
6B7	7/6	6L41	8/6	812	3/9	12R7	5/6	EF22	8/6	LP220	6/6	U6	10/-	VT52	8/6
6B7	7/6	6L42	8/6	812	3/9	12R7	5/6	EF22	8/6	LP220	6/6	U6	10/-	VT52	8/6
6B7	7/6	6L43	8/6	812	3/9	12R7	5/6	EF22	8/6	LP220	6/6	U6	10/-	VT52	8/6
6B7	7/6	6L44	8/6	812	3/9	12R7	5/6	EF22	8/6	LP220	6/6	U6	10/-	VT52	8/6
6B7	7/6	6L45	8/6	812	3/9	12R7	5/6	EF22	8/6	LP220	6/6	U6	10/-	VT52	8/6
6B7	7/6	6L46	8/6	812	3/9	12R7	5/6	EF22	8/6	LP220	6/6	U6	10/-	VT52	8/6
6B7	7/6	6L47	8/6	812	3/9	12R7	5/6	EF22	8/6	LP220	6/6	U6	10/-	VT52	8/6
6B7	7/6	6L48	8/6	812	3/9	12R7	5/6	EF22	8/6	LP220	6/6	U6	10/-	VT52	8/6
6B7	7/6	6L49	8/6	812	3/9	12R7	5/6	EF22	8/6	LP220	6/6	U6	10/-	VT52	8/6
6B7	7/6	6L50	8/6	812	3/9	12R7	5/6	EF22	8/6	LP220	6/6	U6	10/-	VT52	8/6
6B7	7/6	6L51	8/6	812	3/9	12R7	5/6	EF22	8/6	LP220	6/6	U6	10/-	VT52	8/6
6B7	7/6	6L52	8/6	812	3/9	12R7	5/6	EF22	8/6	LP220	6/6	U6	10/-	VT52	8/6
6B7	7/6	6L53	8/6	812	3/9	12R7	5/6	EF22	8/6	LP220	6/6	U6	10/-	VT52	8/6
6B7	7/6	6L54	8/6	812	3/9	12R7	5/6	EF22	8/6	LP220	6/6	U6	10/-	VT52	8/6
6B7	7/6	6L55	8/6	812	3/9	12R7	5/6	EF22	8/6	LP220	6/6	U6	10/-	VT52	8/6
6B7	7/6	6L56	8/6	812	3/9	12R7	5/6	EF22	8/6	LP220	6/6	U6	10/-	VT52	8/6
6B7	7/6	6L57	8/6	812	3/9	12R7	5/6	EF22	8/6	LP220	6/6	U6	10/-	VT52	8/6
6B7	7/6	6L58	8/6	812	3/9	12R7	5/6	EF22	8/6	LP220	6/6	U6	10/-	VT52	8/6
6B7	7/6	6L59	8/6	812	3/9	12R7	5/6	EF22	8/6	LP220	6/6	U6	10/-	VT52	8/6
6B7	7/6	6L60	8/6	812	3/9	12R7	5/6	EF22	8/6	LP220	6/6	U6	10/-	VT52	8/6
6B7	7/6	6L61	8/6	812	3/9	12R7	5/6	EF22	8/6	LP220	6/6	U6	10/-	VT52	8/6
6B7	7/6	6L62	8/6	812	3/9	12R7	5/6	EF22	8/6	LP220	6/6	U6	10/-	VT52	8/6
6B7	7/6	6L63	8/6	812	3/9	12R7	5/6	EF22	8/6	LP220	6/6	U6	10/-	VT52	8/6
6B7	7/6	6L64	8/6	812	3/9	12R7	5/6	EF22	8/6	LP220	6/6	U6	10/-	VT52	8/6
6B7	7/6	6L65	8/6	812	3/9	12R7	5/6	EF22	8/6	LP220	6/6	U6	10/-	VT52	8/6
6B7	7/6	6L66	8/6	812	3/9	12R7	5/6	EF22	8/6	LP220	6/6	U6	10/-	VT52	8/6
6B7	7/6	6L67	8/6	812	3/9	12R7	5/6	EF22	8/6	LP220	6/6	U6	10/-	VT52	8/6
6B7	7/6	6L68	8/6	812	3/9	12R7	5/6	EF22	8/6	LP220	6/6	U6	10/-	VT52	8/6
6B7	7/6	6L69	8/6	812	3/9	12R7	5/6	EF22	8/6	LP220	6/6	U6	10/-	VT52	8/6
6B7	7/6	6L70	8/6	812	3/9	12R7	5/6	EF22	8/6	LP220	6/6	U6	10/-	VT52	8/6
6B7	7/6	6L71	8/6	812	3/9	12R7	5/6	EF22	8/6	LP220	6/6	U6	10/-	VT52	8/6
6B7	7/6	6L72	8/6	812	3/9	12R7	5/6	EF22	8/6	LP220	6/6	U6	10/-	VT52	8/6
6B7	7/6	6L73	8/6	812	3/9	12R7	5/6	EF22	8/6	LP220	6/6	U6	10/-	VT52	8/6
6B7	7/6	6L74	8/6	812	3/9	12R7	5/6	EF22	8/6	LP220	6/6	U6	10/-	VT52	8/6
6B7	7/6	6L75	8/6	812	3/9	12R7	5/6	EF22	8/6	LP220	6/6	U6	10/-	VT52	8/6
6B7	7/6	6L76	8/6	812	3/9	12R7	5/6	EF22	8/6	LP220	6/6	U6	10/-	VT52	8/6
6B7	7/6	6L77	8/6	812	3/9	12R7	5/6	EF22	8/6	LP220	6/6	U6	10/-	VT52	8/6
6B7	7/6	6L78	8/6	812	3/9	12R7	5/6	EF22	8/6	LP220	6/6	U6	10/-	VT52	8/6
6B7	7/6	6L79	8/6	812	3/9	12R7	5/6	EF22	8/6	LP220	6/6	U6	10/-	VT52	8/6
6B7	7/6	6L80	8/6	812	3/9	12R7	5/6	EF22	8/6	LP220	6/6	U6	10/-	VT52	8/6
6B7	7/6	6L81	8/6	812	3/9	12R7	5/6	EF22	8/6	LP220	6/6	U6	10/-	VT52	8/6
6B7	7/6	6L82	8/6	812	3/9	12R7	5/6	EF22	8/6	LP220	6/6	U6	10/-	VT52	8/6
6B7	7/6	6L83	8/6	812	3/9	12R7	5/6	EF22	8/6	LP220	6/6	U6	10/-	VT52	8/6
6B7	7/6	6L84	8/6	812	3/9	12R7	5/6	EF22	8/6	LP220	6/6	U6	10/-	VT52	8/6
6B7	7/6	6L85	8/6	812	3/9	12R7	5/6	EF22	8/6	LP220	6/6	U6	10/-	VT52	8/6
6B7	7/6	6L86	8/6	812	3/9	12R7	5/6	EF22	8/6	LP220	6/6	U6	10/-	VT52	8/6
6B7	7/6	6L87	8/6	812	3/9	12R7	5/6	EF22	8/6	LP220	6/6	U6	10/-	VT52	8/6
6B7	7/6	6L88	8/6	812	3/9	12R7	5/6	EF22	8/6	LP220	6/6	U6	10/-	VT52	8/6
6B7	7/6	6L89	8/6	812	3/9	12R7	5/6	EF22	8/6	LP220	6/6	U6	10/-	VT52	8/6
6B7	7/6	6L90	8/6	812	3/9	12R7	5/6	EF22	8/6	LP220	6/6	U6	10/-	VT52	8/6
6B7	7/6	6L91	8/6	812	3/9	12R7	5/6	EF22	8/6	LP220	6/6	U6	10/-</		

# THE "BUY" OF THE YEAR

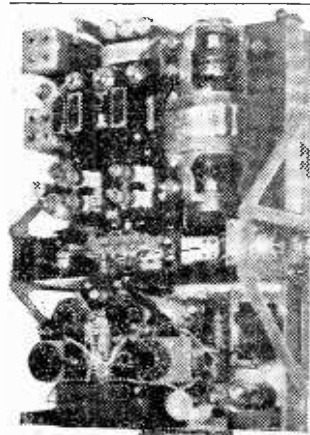

## JUST LOOK WHAT THEY CONTAIN

A fine 6 valve superhet containing:— 2 EF39, 2 EF38, 1 EK32, 1 EBC33 and 2 460 1F Transformers.

## AN EXCELLENT 3 VALVE TRANSMITTER

Containing:—TTL (ideal for 2 meters), EL32, EF50, GENERATOR UNIT with smoothing, etc. Also the outfit contains relays, standard condensers, resistors, transformers and a host of useful components.

## AND FOR BREAKING UP

We are offering complete in perfect working order, but soiled cases, etc., at the AMAZING PRICE OF £2 each, plus 8/6 carriage.

We are offering AS NEW, COMPLETE TR.1196 TRANCEIVERS, as illustrated. Outfit comprises, 6 valve Superhet, 3 Valve Transmitter, Power Unit and Relay Unit. All complete on Chassis. Present range 4.6-5 mcs and output 2 watts. Can be easily converted to cover 1.5 mcs-7 mcs and power outputs up to 8 watts. It has a most versatile Receiver which can be easily adapted to cover any band of frequencies from medium broadcast to 30 mcs. The Transmitter range can also be easily extended and by simply adding 200 pF condenser to tank circuit will cover 1.5 mcs. Circuit and conversion details included with each unit. Each outfit is despatched in transit case at the amazing low price of £3, plus carriage 10/-. If despatched without Transit Case, £2/10/-, plus 8/6 carriage.

## Large Quantities of Our Unused Component Bargains still available at Prices below Manufacturing Costs

Ceramic Variable Condensers split stator 15/15 Pf., 2/6 each. Ceramic Trimmers 22 Pf., 5/- per doz. Variable Condensers 100 Pf. ceramic insulation, 2/- each. Variable Condensers in screening case 50 Pf., 1/- each. Permaloid Sleevings coils of approx. 1 gross yds. 1 mm. and 1.5 mm. 8/6 per coil. Wave Change Switches 2 wafer 6 pole 3-way standard 1 spindles, 1/3 each. Pots 100 K and 1 meg. 1 spindle and 3-gang each 70 K all at 1/- each. Humdinger Pots 100 ohm, miniature wire wound and Colvern do. 200 Ohms 5 w., 2/- each. 100 K Miniature Pots 1in. long spindle, 1/- each. Eric Resistors, 47 K, 2-watt, boxed in 50's and 5's. Also 150 K, 22 K, 70 K, 1-watt. Price: 2 w., 3d. ea. 1 w., 2d. ea. Wire Wound Vitreous, 10-watt, wire ends 500Ω, 9d. ea. Voltage Regulators, 110/30 ma. 2-pin base. Two in series for 230 volts, 3/- ea.

Add sufficient for postage to cover all items above.

**WOOLLEYS RADIO & ELECTRICAL SUPPLIES LTD.**  
615 BORDLESLEY GREEN, BIRMINGHAM, 9. Phone: VIC 2078

# MAXI-Q TWO NEW COMPONENTS

REGD

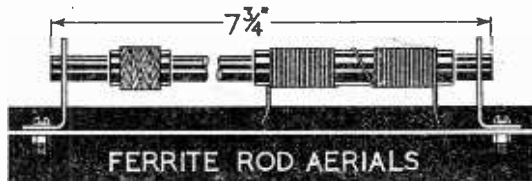

### FERRITE ROD AERIALS

FRA.1. Dual Wave for 300 pF Tuning (12/6 ea.). Suitable Oscillator Coils "Miniature Dual Purpose." Range 1 Red, and Range 2 Red (3/11 ea.).

FRA.2. Dual Wave for 500 pF Tuning (12/6 ea.). Suitable Oscillator Coils F/LW and F/MW (3/11 ea.).

Litz wound M.W. coils and Wavewound L.W. coils wound on high permeability Ferromagnetic rods 7 3/4 in. x 5/16 in. dia. No separate aerial coil or external aerial is required. Inductance is easily adjusted for alignment. Gives high selectivity with consequent reduction in second channel and adjacent channel whistles. Ideal for portable receivers. Supplied complete with insulated mounting brackets. Send 6d. in stamps for leaflet giving suitable circuits and layout with full application data.

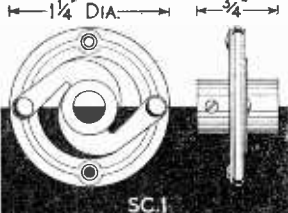

### FLEXIBLE SPINDLE COUPLERS. SC.1. Price 2/6 each.

The lining up of coupled components is made easy with these Polythene insulated flexible couplers. They are completely flexible but entirely free from backlash. The insulator is 1 1/2 in. dia. and the complete coupler is 3/4 in. in width. The bushes are drilled for 1/4 in. dia. spindles.

Obtainable from all reputable stockists or in cases of difficulty direct from works. General Catalogue covering technical information on full range of components, 1/- post paid.

## DENCO (CLACTON) LTD.

357-9 OLD ROAD, CLACTON-ON-SEA, ESSEX.

STOP PRESS—"MULLARD F.M. TUNER."—I.F. Rejectors, Ref. 510/IFF, 2/6. Aerial Coil L1/L2, Ref. 510/AE, 4/6. Choke L3, Ref. 510/RFC, 2/-. R.F. Coil L4, Ref. 510/RF, 2/6. Oscillator Coil L5/L6, Ref. 510/OSC, 4/6. 1st I.F.T. L7/L8, Ref. 510/IFT1, 7/6. 2nd I.F.T. L9/10, Ref. 510/IFT2, 7/6. Ratio Detector Transformer L11/12/13, Ref. 510/RDT, 12/6.

Aluminium Chassis, completely punched, 12/-.

"OSRAM F.M. TUNER."—Chassis, Front Panel, Printed Dial Plate and Drive Mechanism, 37/6. Aerial Coil O/T1, 2/9. R.F. Coil O/L1, 2/6. Oscillator Coil O/L2, 2/-. 1st, 2nd and 3rd I.F.T's, IFT.11/10.7, 6/-, each. Ratio Discriminator Transformer O/T2 (T5), complete with crystals, 19/6.

# ALL AT MANUFACTURERS COST !

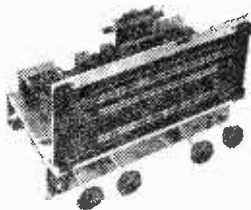

## RADIO RECEIVER CHASSIS

Built to the highest specifications, these chassis offer the finest value to the enthusiast. Supplied with set of selected knobs. Socket panels for aerial, earth, speaker, Pick-up and Gram motor. 200/250 v. 50 cycles only.

### TYPE A (5 Valves)

Three-wavebands Superhet with full negative feedback and A.V.C. Built-in Ferrite antenna. Full-range tone-control. **£9.19.6.**

### TYPE B (7 Valves)

Three-wavebands Superhet with specially designed push-pull output stage. Separate bass and treble control. **£15.14.6.**

## SPECIAL F.M. CHASSIS

A six-valve pure F.M. chassis with single waveband only, covering all existing and projected B.B.C. F.M. transmissions. Highest degree of I.F. amplification, making it ideally suitable for fringe areas. Output stage specially designed around an EL41 output valve, ensuring a really wide, audible frequency range. Permeability-tuned circuit with high stability factor. Special wide-range tone control. Output 4 watts, A.C., 50 cycles only. Provision for external **13 guineas.** Speaker. Co-axial socket for dipole aerial.

## AM/FM CHASSIS

A nine-valve AM/FM chassis with 4 wavebands (Long, Medium, Short and F.M.), push-pull output stage and magic-eye for precision tuning. Specially designed, with permeability-tuned F.M. circuit and a very high degree of I.F. amplification for fringe-area reception, it offers the finest quality regardless of price. Automatic volume-control and a special wide-range tone control. Push-pull output stage and compensated network for electrostatic treble speaker, with an output of 5 watts and the widest possible audible frequency range. Special large 10in high flux-density F.M. Speaker with hyperbolic cone plus matched high-tone electrostatic Speaker. Co-axial socket for dipole aerial. A.C. 50 cycles only. Provision for **23 guineas.** external speaker.

## A.M. CHASSIS

Five-valve Superhet. Two waveband (Medium and Long) A.C./D.C. 200-250 volts. Output 4 watts. Controls: tuning, on/off volume, wavechange. Developed to meet the demand for an inexpensive instrument with no sacrifice in the quality of its reproduction and output. **8 guineas.** [Packing and Carriage for all Chassis, 12/6.]

## LOUDSPEAKERS

Cat. No. LS/10.—10in. Standard **£1.5.0**  
 Cat. No. LS/E74.—7in. x 4in. Elliptical **19/6**  
 Cat. No. LS/5.—5in. Standard **17/6**  
 Electrostatic Loudspeaker LSH75 for treble response. **11/6**  
 Packing and Carriage 3/-

**Domestic  
DIRECT SALES LTD.**

36, SOUTHAMPTON ST. STRAND, LONDON, W.C.2.

## CABINETS

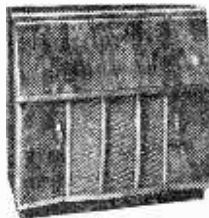

The magnificent Bureau type Cabinet illustrated is in specially selected walnut veneered exterior with light sycamore interior with matching Rexine lining. Two full-sized compartments. Overall measurements: 34in. x 17in. x 33in. **£17.0.0.** high. Price

Other high quality cabinets are available at prices ranging from 10 guineas. Packing and Carriage 15/-.

## \* SPECIALLY RECOMMENDED

### DISC PLAYER

Specially designed for the amateur builder, these Disc Players consist of the latest three-speed Automatic Record Changers, complete with crystal turn-over pick-up head for long-playing and standard records, mounted on sycamore-lined base. Supplied complete with fitted mains lead and screened pick-up lead, ready for connecting up.

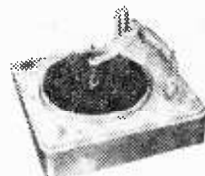

Price **£10.16.0.**  
 Packing and Carriage 7/6.

## AUTOMATIC RECORD CHANGERS

Cat. No. RC/A.—B.S.R. Monarch, or latest Collaro, 3-speed. **£9.15.0**  
 Cat. No. RC/B.—Garrard RC80, 3-speed, automatic A.C. mains. **£13.0.0**  
 Cat. No. RC/C.—Garrard RC80, 3-speed, automatic A.C./D.C. Universal **£26.10.0**  
 Packing and Carriage 7/6.

## TAPE RECORDER



In a superbly fitted moroccan-grained carrying case, this instrument is the very finest of its class, regardless of price. Latest type TRUVOX twin-speed Tapedeck. Input for Radio, Gram., and Microphone. Built-in selected elliptical Speaker of the very finest quality. Recording (with recording level indicator) or Play-back. 200/250 volts 50 cycles, A.C. mains only. Supplied complete with selected Microphone and Record-**42 guineas.** ing Tape.

## TAPE DECKS

TRUVOX 2-speed, twin track. Tapedeck of the latest type, with push-button controls. **£23.2.0.**  
 Packing and Carriage 5/-

TAPE RECORDER, Amplifier only. Built to the highest standards, magic eye for indicating recording level. **12 guineas.**

Packing and Carriage 7/6

**ALL FULLY GUARANTEED  
GENEROUS HIRE PURCHASE TERMS**

# HOME RADIO OF MITCHAM

187, LONDON ROAD, MITCHAM, SURREY.

MIT. 3282.

## AND NOW—The "912 PLUS"

Full details of this brand new quality amplifier and how to improve and modernise the original 912. PRICE 4/-.

### COMMERCIAL TELEVISION Converter Kit

Complete kit of parts including valves, ready wound TELETRON coils, punched chassis, down to the last nut and bolt. Suitable T.R.F. or superhet receivers. PRICE £2 15s. 0d. Circuit details, 6d. post paid.

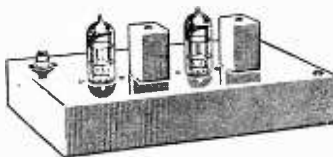

DEMONSTRATION MODEL WORKING.

**MIDLANDS READERS**—Build this well-ried Teletron Converter for your own programme—NOW.

### BAND III AERIALS

Single dipole loft or room use ...	7/6
3 element yagi loft aerial ...	30/-
5 element yagi loft aerial ...	42/6
Many other types in stock	
Belling Lee Diplexer tuned filters ...	12/6
Addex units for dipoles ...	7/6
For H or X ...	15/-
Airspaced low loss coaxial cable ...	9d.yd.

### SMALL POWER UNITS

No. 1. A.C. mains. Output 250 v. 50 mA, 6.3 v. 1.5 A. Ideal for F.M. Tuners, etc. Complete kit with diagram, 4s.  
No. 2. A.C. mains. Output 200 v. 25 mA, 6.3 v. 0.6 A. Specially designed for Band III converters. Complete kit with diagram, £1/10/-.

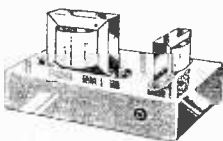

### FREQUENCY MODULATION TUNERS

All parts in stock and demonstration models working.

**DENCO** full constructional details, 1/6.

**JASON** (Radio Constructor), details, 2/- (illustrated).

**OSMOR** F.M. coils, etc., in stock.

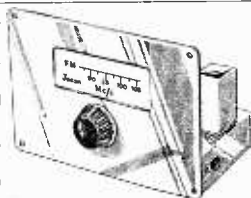

### NEW BOOKS

**MULLARD VALVE DATA MANUAL**, 10/6.  
**BRIMAR No. 6 VALVE DATA BOOK**, 5/-.  
**COLOUR TELEVISION**, 8/6.  
**TV AERIAL MANUAL**, 4/6.  
**MULLARD HIGH QUALITY SOUND REPRODUCTION AND F.M. BOOK**. Including additional information on the "Five-Ten." PRICE 3/6.

### A NEW HOME CONSTRUCTOR ALL-DRY BATTERY PORTABLE

Latest valves and Ferrite rod aerial in high gain Long and Medium superhet circuit. Full constructional plans. PRICE 1/6.

### NEW MULLARD "FIVE-TEN"

All parts in stock including chassis, all transformers, condensers, exact value resistors. S.A.E. for full list.

**GARRARD**. New. 3-speed transcription unit, model "301" few only. £25/3/6.

The full range of  
**EDDYSTONE**

short wave components in stock. Eddystone catalogue price 1/-.

## R.S.C. MAINS TRANSFORMERS (FULLY GUARANTEED)

Interleaved and impregnated. Primaries 200-230-250 v. 50 c/s Screened. **TOP SHROUDED DROP THROUGH**  
250-0-250 v. 70 mA, 6.3 v. 2.5 a ... 13/9  
250-0-260 v. 70 mA, 6.3 v. 2 a, 5 v. 2 a ... 16/9  
350-0-350 v. 100 mA, 6.3 v. 2 a, 5 v. 2 a ... 18/9  
250-0-250 v. 100 mA, 6.3 v. 4 a, 5 v. 3 a, 22/9  
300-0-300 v. 100 mA, 6.3 v. 4 a, 5 v. 3 a, 22/9  
350-0-350 v. 100 mA, 6.3 v. 4 a, 5 v. 3 a, 22/9  
350-0-350 v. 100 mA, 6.3 v. 4 a, C.T. ... 23/9  
350-0-350 v. 150 mA, 6.3 v. 4 a, 5 v. 3 a, 23/9  
250-0-250 v. 150 mA, 6.3 v. 2 a, 6.3 v. 2 a, 5 v. 3 a ... 31/6

**FULLY SHROUDED UPRIGHT**  
250-0-250 v. 60 mA, 6.3 v. 2 a, 5 v. 2 a. Midget type 21-3-31n ... 17/6  
350-0-350 v. 70 mA, 6.3 v. 2 a, 5 v. 2 a ... 19/9  
250-0-250 v. 100 mA, 6.3 v. 4 v. 4 a ... 26/9  
C.T. 0-4-5 v. 3 a ... 26/9  
250-0-250 v. 100 mA, 6.3 v. 4 a, 5 v. 3 a. For R1355 conversion ... 31/-  
300-0-300 v. 100 mA, 6.3 v. 4 v. 4 a. C.T. 0-4-5 v. 3 a ... 26/9  
350-0-350 v. 100 mA, 6.3 v. 4 a, 5 v. 3 a, 23/9  
350-0-350 v. 100 mA, 6.3 v. 4 v. 4 a. C.T. 0-4-5 v. 3 a ... 27/9  
350-0-350 v. 150 mA, 6.3 v. 4 a, 0-4-5 v. 3 a ... 33/9  
425-0-425 v. 200 mA, 6.3 v. 4 a, C.T. 6.3 v. 4 a, C.T., 5 v. 3 a. Suitable Williamson Amplifier, etc. ... 49/9  
450-0-450 v. 250 mA, 6.3 v. 6 a, 6.3 v. 6 a, 5 v. 3 a ... 69/9

**E.H.T. TRANSFORMERS**  
2,500 v. 5 mA, 2-0-2 v. 1.1 A, 2-0-2 v. 1.1 A for VCR97, VCR517, etc. ... 36/6

**ELIMINATOR TRANSFORMERS**  
Primaries 200-250 v. 50 c/s, 120 v. 40 mA  
130 v. 50 mA, 6 v. 3 a ... 14/9

**MIDGET MAINS TRANSFORMER**. Manufacturer's Surplus. Primary 220/240 v. Secs. 230-0-230 v. 60 mA, 6.3 v. 2 a. Only 11/9.

**FILAMENT TRANSFORMERS**  
All with 200-250 v. 50 c/s primaries 6.3 v. 1.5 a, 5/9; 6.3 v. 2 a, 7/6; 0-4-6.3 v. 2 a, 7/9; 12 v. 1 a, 7/11; 6.3 v. 3 a, 8/11; 6.3 v. 6 a, 17/6; 12 v. 3 a or 24 v. 1.5 a, 17/6.

**CHARGER TRANSFORMERS**  
All with 200-230-250 v. 50 c/s Primaries:  
0-9-15 v. 11 a, 11/9; 0-9-15 v. 3 a, 16/9;  
0-9-15 v. 6 a, 22/9.

**SMOOTHING CHOKES**  
250 mA 5 H 100 ohms ... 11/9  
150 mA 7-10 H 250 ohms ... 11/9  
100 mA 10 H 175 ohms Potted ... 8/6  
60 mA 10 H 350 ohms ... 5/6  
60 mA 10 H 400 ohms ... 4/11

**OUTPUT TRANSFORMERS**  
Midget Battery Pentode 66; 1 for 3S4, etc. ... 3/9  
Small Pentode 5,000 Ω to 3 Ω ... 3/9  
Standard Pentode, 5,000 Ω to 3 Ω ... 4/9  
Standard Pentode, 75,000 Ω to 3 Ω ... 4/9  
Standard Pentode, 10,000 Ω to 3 Ω ... 4/9  
Multi-ratio 40 mA, 30; 1, 45; 1, 60; 1, 90; 1, Class B Push-Pull ... 5/6  
Push-Pull 10-12 watts 6V6 to 3n or 15 Ω. Sectionally wound ... 16/9  
Push-Pull 10-12 watts to match 6V6 to 3-5-8 or 15 Ω ... 16/9  
Push-Pull 20 watts, sectionally wound 6L6, KT66, etc., to 3 or 15 Ω 47/9  
Williamson type exact to spec. ... 85/-

**SILVER MICA CONDENSERS**. 5, 10, 15, 20, 25, 30, 35, 40, 50, 100, 120, 150, 200, 230, 300, 400, 500, 1,000 (.001 mfd.), 2,000 pfd. (.002 mfd.), 6d, each; 3/9 doz. One type.

**I.T. ELIMINATOR AND TRICKLE CHARGER KIT**. Input 200-250 v. A.C. Output 120 v. 40 mA. Fully smoothed and priced supply to charge 2 v. accumulator. Refitted with louvered metal case and circuit, 28/6. Or ready for use, 8/9 extra.

**EX-GOVT. TRANSFS.** 230/250 v. 50 c/s. 8.8 v. 4 a, 9/9; 48 v. 1 a, 9/9; 460 v. 200 mA, 6.3 v. 5 a, 27/9; 325-0-325 v. 150 mA, 6.3 v. 4 a, 5 v. 2-3 a, 27/9; 250-0-250 v. 60 mA, 6.3 v. 2 a, 5 v. 2 a, Potted 11/9; Carr. on following types, 5/- extra. 7.7 v. 7 a, C.T., 4 times, 25/9; 400 v. C.T. 150 mA, 4 v. 6 a, 6.3 v. 6 a, 6.3 v. 0.6 a, 4 v. 6 a, 4 v. 3 a, 4 v. 3 a, 5 v. 2 a, 22/9.

**EX-GOVT. AUTO TRANSFORMERS**  
50 v. c/s. Double wound 10-0-200-220-240 v. to 10-0-275-295-315 v. 1,000 watts. Suitable for 100 v. to 230-250 v. or reverse if windings series connected. 59/6. Single winding 15-10-5-0-195-215-235 v. 500 watts, 27/9.

**EX-GOVT. SMOOTHING CHOKES**  
250 mA, 10 H 50 ohms ... 14/9  
150 mA, 10 H 100 ohms ... 11/9  
150 mA, 10 H 150 ohms Trop. ... 8/8  
100 mA, 10 H 150 ohms Tropicalised ... 3/11  
L.T. type 1 amp. 2 ohms ... 2/9

**EX-GOVT. METAL BLOCK (PAPER) CONDENSERS**  
4 mfd. 500 v. 2/9; 4 mfd. 1,500 v. 4/9; 6-6 mfd. 450 v. 5/11; 8-8 mfd. 500 v. 6/9; 4 mfd. 400 v. plus 2 mfd. 250 v. 1/11; 8 mfd. 500 v. 5/9; 15 mfd. 500 v. 6/9.

**EX-GOVT. E.H.T. SMOOTHERS**  
.02 mfd. 8,000 v. cans, 1/11; .25 mfd. 4,000 v. Blocks, 4/9; .5 mfd. 2,500 v. Blocks, 3/9; .5 mfd. 3,500 v. cans, 3/3; 1.5 mfd. 4,000 v. Blocks, 5/9.

EX-GOVT. VALVES (NEW)					
17A	7/9	6V8GT	6/9	6AT6	7/9
1R5	7/9	6X5GT	7/9	EL32	3/9
1S5	7/9	807	7/9	EF36	4/9
5Y3G	8/11	12A6	7/9	EB91	8/9
5Z4G	9/9	15D2	4/9	EF91	7/9
6K7G	5/11	25Z4G	9/9	KT66	11/9
6X8G	9/9	35Z4GT	10/6	KT44	8/9
6SN7GT	8/9	6L6G	11/9	SP41	1/11
6P6G	7/9	MH4	4/9	SP61	2/9
EF39	5/9	EB33	6/9	PX25	14/9

**RF26 UNITS BRAND NEW CARTONED**. Only 29/6. Carr. 2/6.

**RADIO SUPPLY CO. (Leeds) LTD.**  
32, THE CALLS, LEEDS, 2 (For Terms see full page advert.)



# 9 Octave realism

The G.E.C. metal cone loudspeaker gives lifelike reproduction of any type of sound over a range of 9 octaves. This includes the whole musical fundamental range with overtones. This gives the true tonal quality and character that all music lovers demand.

## from a single unit

Sound engineers will appreciate the simplification — and the improvement in performance — which has been achieved by combining these qualities in a single unit — \*smooth response over a range of 9 octaves, with extremely good low frequency response . . . \*negligible inter-modulation . . . \*unequaled transient response due to special coil and cone construction.

# for only £8.15.0

This is a professional instrument but its remarkably low price makes it particularly valuable to the home constructor. It must be used under the correct conditions to obtain optimum results. Cabinets have been specially designed for use with this speaker. Home constructors are invited to write for details.



## Metal Cone Loudspeaker

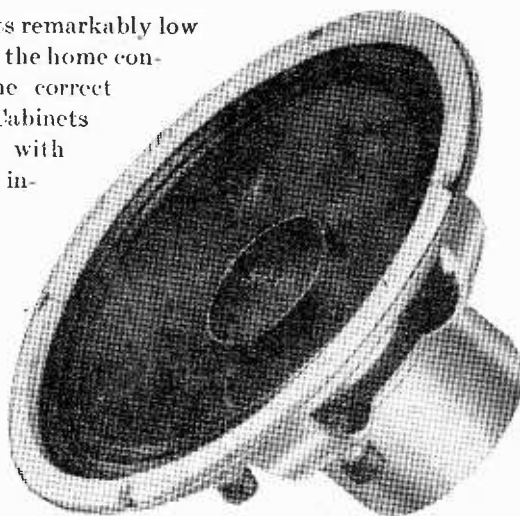

THE GENERAL ELECTRIC COMPANY LTD., MAGNET HOUSE, KINGSWAY, W.C.2

# LASKY'S RADIO

## EVERYTHING FOR THE HOME CONSTRUCTOR • RADIO OR TV

### 12 CHANNEL TV TUNER



Famous make. Covers Bands I and III. Complete with Valves EF80 and ECC81. Ceramic valve holders, finest quality components, precision made. Switch and fine tuning. I.F. output 20-25 and 40-50 Mc/s. Freq. coverage 50-87 Mc/s and 175-215 Mc/s. Supplied with full details and circuit diagram. **LASKY'S PRICE, 89/6**  
Post & pkg., 3/6  
Knob 2/9 extra. 1

PLEASE ADDRESS ALL MAIL ORDERS TO HARROW ROAD

Open  
all day  
SAT.  
Half day  
Thurs.

**LASKY'S (HARROW ROAD) LTD.,**

42, TOTTENHAM COURT ROAD, W.1.

Telephone: MUSEum 2805.

370, HARROW ROAD, PADDINGTON, W.9.

Telephone: CUNningham 1979-7214.

### SAVE POUNDS ON THIS FINE 6-valve

#### RADIOGRAM CHASSIS

Famous Maker's Surplus, Brand New and Complete. 6 valve, 3-wave Superhet, 13-50 m. short, 200-550 m. medium, 1,000-2,000 m. long. Brand new Mullard valves: ECH42, EF41, L63, EB41, 6V6, g.t., E240, and finest quality components. Gram. switch, 465 Kc/s I.F., tone control, 3-colour dial. Overall size: 13½ x 5, height 12½ in. Aperture required for dial and controls, 11 x 3½ in. Complete with valves, output trans., knobs, etc.

**LASKY'S PRICE, £10.19.6**  
Carr. & pkg., 7/6 extra.

**PICK-UPS ALMOST HALF PRICE.** Standard Play. Goldring Bantam magnetic, or Acos Crystal type GP10.

**25/-** Post free.

#### ACOS CRYSTAL CARTRIDGES

Turn-over type GP23, with sapphire stylus. List 42/11.

**LASKY'S PRICE, 18/6**  
Post free.

### B.S.R. MONARCH 3-SPEED AUTO-CHANGERS

Latest 1955 model. New and Unused in Maker's Cartons. Takes 10 records of all sizes (mixed) in one loading. HGP.37 crystal turnover pick-up. Handsome cream finish. List 13 Gns. **LASKY'S PRICE, £7.19.6**  
Carr. 3/6

**NOTE.** An attractive contemporary design Cabinet, oak veneer, to house the above Auto-Changer and the Radiogram Chassis offered on left, is available at £3.19.6, Carr. 17 6

Collaro Tape Deck Motors, anti-clockwise, shaded pole. **LASKY'S PRICE 25/-**  
Post extra

**TELETRON BAND III CONVERTER COIL SET** for use with TRF and superhet Band I receivers. Uses 2 Z719. Circuit, wiring diagram, alignments with each set. **15/-** Post 1/6.

**TELETRON BAND III CONVERTER.** Complete kit, drilled chassis, condensers, resistances, coils, valves, etc., with full instructions, **48/6** Post 1/6.

Drilled Chassis only, 3/9. All components available separately.

### LASKY'S RADIO CONSTRUCTOR PARCELS

**PARCEL No. 1.**—Contains everything to build a 4-valve, 3-wave superhet for 200/250 A.C. mains. Uses 6K8, 6K7, 6Q7, 6V6 valves. Attractive wood cabinet, walnut veneer, or plastic cabinet. Size 12 x 6½ x 5½ in. deep. **CAN BE BUILT FOR £7.19.6.** Carr. and pkg. 2/6.

**PARCEL No. 2.**—Contains everything to build a T.R.F. 3-valve set for 200/250 A.C. mains, med. and long wave. Uses 6K7G, 6J7, 6V6, and metal rectifiers. Neat plastic cabinet, walnut or ivory finish, or wood cabinet. Size 12 x 6½ x 5½ in. deep. **CAN BE BUILT FOR £5.10s.** Carr. and pkg. 2/6.

**PARCEL No. 3.**—4-watt A.C. Amplifier.—Uses 1 each 6SL7, 6V6 and 5Z4. All components, chassis, valves, output trans., mains trans. **LASKY'S PRICE, £4.5s.** Post & pkg. 2/6 extra.

Instruction Books for any of above, 1/- each, post free. Cabinet only, plastic or wood, 17 6 post 2 6.

# Brenell

—best value  
in quality  
Tape Decks

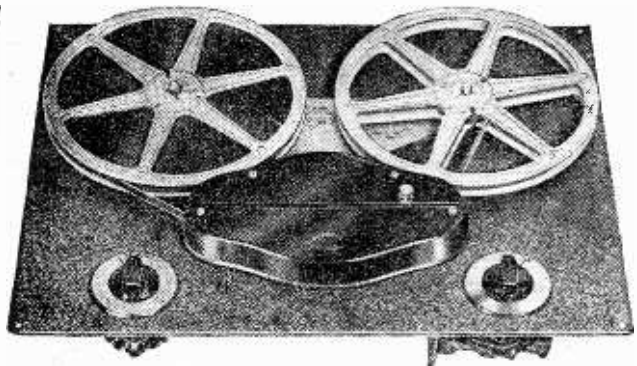

WITH ALL THE FEATURES — at a price anyone can afford **18 GNS**

- Heavy Duralumin Baseplate 15" x 11½"
- Three independent motors
- Three speeds: 3¾, 7½ and 15 i.p.s.
- Twin-track recording, 7" reels (1,200 ft.)
- Foolproof "drop in" tape loading
- Instant stop without tape spill
- High efficiency mechanical braking system
- Two-knob control with interlocked switching
- Visual playing time indication
- Fast forward or reverse in 45 seconds
- Plays all makes of pre-recorded Tapes
- Azimuth adjustment to Record/Playback Head

**BRENELL RECORDING AMPLIFIER NOW AVAILABLE AT 16½ GNS**

From your Wireless Dealer or in case of difficulty write to sole manufacturers:

**BRENELL ENGINEERING CO. LTD., 2 NORTHINGTON ST. LONDON, W.C.1 : Tel: HOLborn 7358**

**MAKE A SOLDER GUN**

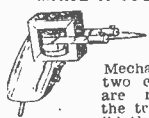

A 7-second solder gun was described in "Practical Mechanics." Only two essential parts are required: (a) the transformer and (b) the push switch. These we can supply at 13/6, plus 2/- post. The rest of the parts you will have in your own "junk" box. Copy of the article concerned given free with the kit.

**TRANSFORMER SNIP**

**10/6**

Post 2/- Fully shielded — standard 200-250 v. primary 230-0-230 at 80 m.a. 6.3 v. at 3 amp., 5 v. at 2 amp.



**THE TWIN 20**

This is a complete fluorescent lighting fitting. It has built-in ballast and starters — stove enamelled white and ready to work. It is an ideal unit for the kitchen, over the work-bench, and in similar location. It uses two 20-watt lamps. Price, complete less tubes, 29/6, or with two tubes, 39/6. Post and insurance 5/-. Extra 20-watt tubes, 7/6 each.



**MAINS-MINI**

Uses high-efficiency coils—covers loins and medium wavebands and fits into the neat white or brown bakelite cabinet—limited quantity only. All the parts, including cabinet, valves, in fact, everything, £4/10/0, plus 3/6 post. Constructional data free with the parts, or available separately 1/5.



**MULLARD AMPLIFIER "510"**

A Quality Amplifier designed by Mullard. Power output exceeds 10 watts. Frequency response almost flat from 10 to 20,000 C.P.S. For use with the Acos "Hi G" and other good pick-ups. Made up and ready to work is £12 10/- or 85/- deposit, plus 10/- carr. and insurance. Available in Kit form. Send for Mullard Shopping List.

**ADDITA—BAND III CONVERTER**



Our Addita is giving very satisfactory results, and we have had many pleasing reports regarding its performance.

It is a very neat-looking unit and fits to the side or the back of the television. It is designed to convert any T.V. superhet or T.R.F. and no internal modifications of any kind are required. Simply plug in the aerials, connect to the mains, and you have Band I or Band III at the flick of a switch. Price £7/10/- and 2/6 post and insurance.

**BUILD IT YOURSELF**

You can save at least £2 on the above if you build the converter yourself. Price of all components, including stove enamelled case and even transfers for the front, is £4/5/-, plus 2/6 post, or £5/5/- if mains components also required. Data is included free with the parts or available separately price 2/6.

**BAND 3 AERIAL KIT**

An interesting aerial. "The Folded V." was described in the July number of this magazine. We tried this and found it to be most efficient. The kit comprises alloy elements and connectors, neat plastic centre piece and saddle for mounting. 3/6 post 1/6.

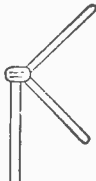

**W.W. Band III Kit**

One of the most successful circuits for Band III conversion at aerial frequency. We offer a complete kit of parts including the specified EF80 valves, wound coils, drilled chassis, in fact, everything including a copy of the circuit diagram. Price only 42/6, post 2/6 extra. Mains components if required 25/- extra. Data available separately, price 1/-. Ready to work—models 65/6, plus 2/6 post.



**ENTIRELY NEW CIRCUIT**

Redesigned and now built by the Cleveland Company—very good reports received.

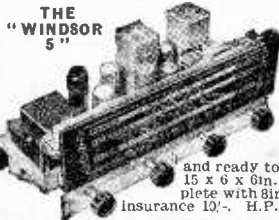

**THE "WINDSOR 5"**

This is a 5-valve A.C. superhet covering the usual long, medium and short wavebands. It has a particularly fine clear dial with an extra long pointer travel. The latest type loctal valves are used and the chassis is complete and ready to operate. Chassis size 15 1/8 x 6 in. Price £9/19/6, complete with 8in. speaker. Carriage and insurance 10/-. H.P. terms if required.

**TABLE RADIO CABINET**

Due to a special purchase, we are able to offer this very fine cabinet, size approx. 15 1/4 x 14 x 6 1/4 in. Walnut veneered and satin finished 37/6, carriage and packing 3/6. Note—This cabinet is the correct one for the Windsor chassis above with 6in. speaker.

**RECORD PLAYER £4-10-0**

**3-speed Gramophone Motor**

Latest rim drive 3-speed motor with metal turn-table and rubber mat. Small mod. makes speed easily variable for special effects and dance work.



**Hi-Fi Pick-Up**

Using famous Cosmocord Hi-G turn over crystal. Separate sapphire for each speed. Neat bakelite case with pressure adjustment.

**Special Snip Offer This Month**

The two units for £4/10/- or 30/- deposit and four payments of 18/-. post and insurance 5/-.

**ELECTRONIC PRECISION EQUIPMENT, LTD.**

Post orders should be addressed to E.P.E. LTD., Dept. 5, 123 Terminus Road, Eastbourne.

Post enquiries to Eastbourne with stamped envelope, please.

42-48, Windmill Hill, Ruislip, Middx. Phone: RUISLIP 5780 Half day, Wednesday.  
152-3, Fleet Street, E.C.4. Phone: FLEET 2833 Half day, Saturday.  
29, Stroud Green Rd., Finsbury Park, N.4. Phone: ARCNWAY 1919 Half day, Thursday.  
249, Kilburn High Road, Kilburn, MAIDA VALE 4921.

**2-INCH ALUMINIUM TUBING**

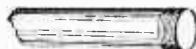

Ideal for making T.V. aerials, etc., 1/6 per foot, 6 feet lengths 8/4.

**CAR STARTER/CHARGER KIT**

All parts to build 6- and 12-volt charger which can be connected to a "flat" battery and will enable the car to be started instantly. Kit comprising the following:—

- Mains transformer ... 19/6
  - 6-amp. rectifier ... 32/6
  - Regulator Stud Switch ... 3/6
  - Resistance Wire ... 2/-
  - Resistance Former ... 2/6
  - Mains on/off Switch ... 1/-
  - 0.5 amp. Moving Coil Meter ... 9/6
  - Constructional Data ... 1/6
- or if bought all together price is 69/8, plus 2/- post and packing.

**INFRAY LAMP WARMER**

Means real comfort in bed as it emits Infra Red Rays which warm and keep you healthy. Economical. Costs only 1d. per hour (elec'v at 1d. per unit).



Price 38/-

Absolutely safe, no health or fire risk. Ideal for many other uses—over pet's basket, rearing pup, chicks, over desk, work-bench, etc. All complete and ready to work.

**Major 4 Lamp 3 switch Model £6/10/0**

**5-VALVE SUPERHET YOURS FOR ONLY 40/- DOWN**

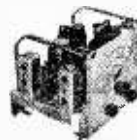

Chassis size approx. 9 1/2 x 7 1/2 x 8 1/2. First-class components. A.C. mains operation. Three wave (medium and short wave shorts). Complete with five valves, ready to work. New and unused. Cash price £5/19/6, or 40/- deposit and 3 monthly payments of 10/- (carr. and ins. 7/6).

**THE CLEVELAND F.M. TUNER**

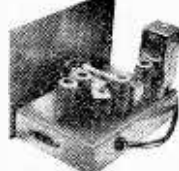

This tuner is based upon the very successful circuit published by Data Publications. We have made up models at all branches and will gladly demonstrate. Stability is extremely good and making and aligning most simple. Cost of all parts including valves, prepared metal chassis, wound coils and stove enamelled scale, slow-motion drive, pointer, tuning knob, in fact everything needed is £6/12/6. Data is included free with the parts or is available separately, price 2/-. Extra for fringe area model. 20/-.

# OSMOR PRESENT THE PICK OF RADIO PRODUCTS

## ★ OSMOR COIL TYPES (All Coils Dust iron cored) Circuits on Request ★

Coil No.	W'band	Winding	$\mu$ H	Price	Coil No.	W'band	Winding	$\mu$ H	Price
QA.1		Aperiodic	.6	1.1 4/-	QA7		Aperiodic	1.4	1.9 4/-
HF1	13-35	"	1.1	4/-	HF7	18-50	"	1.4	1.9 4/-
O1		"	.7	4/-	O7		"	1.2	1.5 4/-
QA2		Aperiodic	1.4	1.9 4/-	QA8		Aperiodic	100	170 4/-
HF2	15-50	"	1.4	1.9 4/-	HF8	190-500	"	100	170 4/-
O2		"	1.1	1.6 4/-	O8		"	65	120 4/-
QA3		Aperiodic	3	5 4/-	QA9		Aperiodic	1,900	2,600 4/-
HF3	35-120	"	3	5 4/-	HF9	800-2,000	"	1,900	2,600 4/-
O3		"	2.5	4.8 4/-	O9		"	400	750 4/-
QA4		Aperiodic	17	42 4/-			Direct cou lin:		
HF4	70-230	"	17	42 4/-	QA10	18-50	S.W. Ae. Coil	1.3	2.1 4/-
O4		"	10	22 4/-			Frame Ae.		
QA5		Single	130	230 4/-	QFA1	190-560	5 1/2 in. x 3 1/2 in.	—	190 2/6
HF5	190-520	"	130	230 4/-	QFA2	190-560	Frame Ae.	—	190 2/6
O5		"	75	140 4/-			6 1/2 in. x 5 1/2 in.	—	
QA6		Single	1,800	2,600 4/-	CL1	600-2,000	L.W. Loading Coil		
HF6	800-2,000	"	1,800	2,600 4/-			(in series with QFA1		
O6		"	400	750 4/-			QFA2) 1,800	2,000	4/-
QA51 Cup Coil	Same Connections as A-HF5			5/-	QA12	800-2,000	L.W. T.R.F. coil	Aperiodic	4/-
QA61	Same Connections as A-HF6			5/-	HF12				
QA81 Cup	Same Connections as A-HF8			5/-	Q1F1	450-570 kc s Filter			4/-
QA91 Cup	Same Connections as A-HF9			5/-	QTB	Tape Recorder Osc.			7/6
QR11	190-560 M.W. Aperiodic with Reaction			4/9	QC1	All-wave R.F. Choke			4/-
QR12	800-2,000 L.W. Aperiodic with Reaction			4/9	QC2	Tape Recorder Osc.			6/9
QA11	190-560 M.W. T.R.F. coil Aperiodic			4/-	QWF1	Whistle Filter			6/9
HF11					QSF1	Scratch Filter			6/9

### OSMOR 'Q' COIL PACKS

Size only 1 1/2 x 3 1/2 x 2 1/2 with variable iron-dust cores and Polystyrene formers. Built-in trimmers. Tropicalised. Prealigned. Receiver tested and guaranteed. Only 5 connections to make. All types for Mains and Battery Superhets and T.R.F. receivers. Ideal for the reliable construction of new sets, also for conversion of the 21 Receiver. TR1196, Type 18, Wartime Utility and others.



### The NEW OSMOR "SWITCH PACK"

Complete and Prealigned full circuit included. State which station required. 2 M.W., 1 L.W. or 3 M.W. **48/-** incl. P. Tax

**FREE!** Send 7id (stamps) for fully descriptive literature including Circuit and practical Drawings

F. M. Tuner. "The really efficient 5-valve Superhet," 6-valve s'het., 3-valve (plus rectifier) T.R.F. circuit, Battery portable Superhet circuit, Coil and Coil-pack leaflets, and full radio and component lists, and interesting miniature circuits. Full scale chassis drawings for all circuits on request.

### SMALL 1/2w RESISTORS 6d. each

4.7 ± 10%	400 ± 20%	15K ± 20%	560K ± 20%
10 "	470 "	22K "	880K "
12 "	560 "	25K "	750K "
15 "	680 "	27K "	820K "
20 "	820 "	33K "	1 meg. "
24 "	1K "	47K "	1.2m "
27 "	1.5K "	50K "	1.5m "
33 "	2.2K "	68K "	2m "
50 "	3.3K "	100K "	2.2m "
68 "	3.5K "	150K "	3m "
100 "	5 watt "	180K "	3.3m "
150 ± 20%	10 watt "	220K "	3.9m "
180 "		270K "	4.7m "
220 "		390K "	5.1m "
270 "		390K "	5.6m "
300 "		470K "	6.8m "
330 "		500K "	10m "

### ULTRA-SMALL CERAMIC NEG. TEM. CO-EFF. CAPACITORS for V.H.F. etc., 10d. each

1pF ± 0.5%	47pF ± 20%	560pF ± 20%
2pF "	56pF "	680pF "
3pF "	68pF "	820pF "
4pF "	70pF "	
5pF ± 20%	82pF "	1,000pF +100%
6pF "	100pF "	-20%
7pF "	150pF "	2,000pF "
10pF "	200pF "	2,500pF "
15pF "	270pF "	3,000pF "
22pF "	330pF "	4,700pF "
33pF "	390pF "	6,000pF "
39pF "	470pF "	10,000pF "

Have you a problem involving circuits in which Osmor Coils or Coil Packs are used, or intended to be used? Let our Technical Team solve it—just write us a letter. We're right up-to-date—we build the various circuits given in "Wireless World," "Practical Wireless," "Radio Constructor," etc., and we stock the components specified. Most Technical Colleges, Universities, etc., use Osmor Coils for research.

### OSMOR STATION SEPARATOR

The Separator may easily be tuned to eliminate any one station within the ranges stated and fitting takes only a few seconds. Aerial Sharp tuning is effected by adjusting the brass in here screw provided.

**7/6**



Plugs into Receiver

Type Meters	Type Meters	Type Meters
1 141-250	4 319-405	7 1450-1550
2 218-293	5 395-432	8 410-550 kc/s.
3 287-341	6 455-567	

Special Separator to clear Radio Luxembourg, 10/6 each.

### READERS' QUERIES!

Dear Sirs,  
Some S.W. S'het circuits use separate valve for frequency changing. Why is this? The main reason is to ensure that the Osc. circuit is free from unwanted couplings, as this tends to cause frequency "pulling." This is also a precaution against frequency drift.

Dear Sirs,  
Why use permeability-tuning in the "Osmor" F.M. Tuner? To ensure frequency-stability (drift).

Dear Sirs,  
Please give me a few general principles on wiring.

Consider layout in relation to wiring. In general the shortest route should be taken. "Cold" wires may be longer. Grid and Anode as short as possible and must not be in parallel or too close. Arrange layout accordingly. Thick short earthing points are essential. Where space permits tag posts are most convenient. Always twist fl. wires.

Thanks for writing, we shall continue these Readers' Queries.

# PRACTICAL WIRELESS

EVERY MONTH  
VOL. XXXI No. 589 NOV., 1955

EDITOR: F. J. CANN

23rd YEAR  
OF ISSUE

COMMENTS OF THE MONTH

BY THE EDITOR

## Show Afterthoughts

THE deplorable strike which delayed the opening of this year's Show affected the total attendance, which, however, allowing for the loss of two days, was still commendable, and on some days was in excess of last year. The real effect, however, was felt by manufacturers interested in the export trade. Foreign buyers, uncertain whether the Exhibition would be held or abandoned, cancelled their bookings and did not attend the Show. The effect of this will not be felt only by the manufacturers concerned, but also by the country as a whole, since every loss of an export order means loss of national revenue. This is the second time that the Radio Show has been hampered by unnecessary strikes and we think that the R.I.C. next year should seek an assurance from Earls Court that they have approached all of the unions concerned and received an undertaking from them that any disputes or grievances will be dealt with before work on the Exhibition commences. The present method of waiting for work to start and then threatening to strike if the claims are not met is unmoral, contrary to the national interests and inimical to the interests of the radio industry. It is wholly despicable to threaten a national exhibition which has nothing whatever to do with the dispute, which, in this case, concerned payment of an exhibition bonus which veiled the real reason, namely, an attempt to make the BBC a closed shop. In matters where the national economy is affected the Government should take drastic measures. The law is at present adequate to deal with such matters.

Apart from that, there were general complaints about the catering and the high prices charged for indifferent food, lack of seating accommodation and the very poor air conditioning. It would be far better to abandon the exhibition for a year rather than let it be used as a cat's-paw for trade disputes which have a political significance.

### "THE BEGINNER'S GUIDE TO RADIO"

READERS will remember the series of articles entitled "A Beginner's Guide to Radio," which ran for over two years in this journal. There has been a consistent demand for now out-of-print issues containing that series. Readers,

therefore, will be interested to know that the articles have been republished in book form, with additional matter and tables, at the price of 7s. 6d. or 7s. 10d. by post. The series has been augmented also by an index. It will be found ideal for teachers and students as an elementary first course in radio transmission and reception. It is written in simple language, and the student is taught theory by means of the construction of simple receivers, the theory and function of each part being explained as the student builds. The book contains 160 pages and 114 diagrams. Readers who missed some of the series should order their copies at once whilst the limited edition lasts.

### CONSTRUCTORS AT THE SHOW

ONCE again it was our pleasure to meet some hundreds of our readers during the run of the Show and to discuss future designs with them. Great interest was evinced in F.M., and we were delighted to learn that so many of our older receivers are still giving faithful service. All the suggestions made by readers are being carefully considered.

### BAND III CONVERTER—FREE GIFT BLUEPRINT

THE October issue of *Practical Television* contains a free gift blueprint of the P.T. Converter for Band III. Constructional details of the converter and power supplies for the converters already described are also given in the issue in the series "Converters for Band III."

The issue also contains "R1124 Conversion for Sound," "TV Dx," which deals with the reception of European and long-distance television stations, "Receiving the I.T.A.," the fourth in a series on the problems involved in receiving commercial programmes on Band III, "Amateur Television Construction" and "Ex-Government C.R. Tubes," the first article in a short series on most of the surplus tubes now available to the constructor.

Commencing with this issue *Practical Television* will be contained every month in a three-colour cover. All five journals in the Practical Group now have this feature. Also included are features on world TV news, letters and answers to readers' TV problems. — F. J. C.



# Round the world of WIRELESS

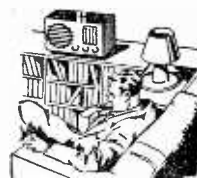

## Broadcasting Receiving Licences

THE following statement shows the approximate number of broadcast receiving licences in force at the end of July, 1955. The grand total of sound and television licences was 14,067,394.

Region	Number
London Postal ... ..	1,452,396
Home Counties ... ..	1,396,458
Midland ... ..	1,125,674
North Eastern ... ..	1,487,190
North Western... ..	1,142,403
South Western ... ..	928,832
Wales and Border Counties ... ..	582,648
<b>Total England and Wales</b> ... ..	<b>8,115,601</b>
Scotland ... ..	1,006,839
Northern Ireland ... ..	219,371
<b>Grand Total...</b> ... ..	<b>9,341,811</b>

## Wrotham on Full Power

THE V.H.F. sound station at Wrotham in Kent is now operating on full power. The Home, Light and Third Programmes are

By "QUESTOR"

being transmitted with an effective radiated power of 120 kW.

The transmitter commenced operation in May with reduced power in order to make the V.H.F. service available to listeners in London and South-East England as soon as possible.

## New Deaf-Aid Patented

IN his report for 1954, the Comptroller-General of Patents, Designs and Trade Marks reveals the patenting of a new form of deaf-aid which is worn on the frame of a pair of spectacles.

## Critics Invited

THE BBC has issued an invitation to radio listeners in India to join a panel of critics of the special programme in English called "London Calling Asia."

This programme is broadcast every day from London for listeners in South-East Asia and the Far East. The BBC is anxious to learn the Asian viewpoint on the series.

## Radio Waves from Jupiter

DR. BOWEN, chief of the Radio-Physics Department of the Commonwealth Scientific and Industrial Research Organisation in Australia, has stated that very strong radio waves are being received from an unknown spot on Jupiter.

They are travelling across 500 million miles of space and new instruments and equipment are

being constructed, including a 250ft. radio telescope, in an effort to find out more about them.

## Brit.I.R.E. Premium Awards

THE Council of the Brit.I.R.E. has announced the recipients of Institution Premiums for papers published in 1954, and for papers read at the Industrial Electronics Convention held at Oxford in July, 1954.

The premier award, *The Clerk Maxwell Premium*, has been presented to F. N. H. Robinson, M.A., for "Microwave Shot Noise in Electron Beams and the Minimum Noise Factor of Travelling Wave Tubes and Klystrons."

## In The Classroom

WHEN the BBC's Broadcasts to Schools restarted on September 19th, exactly a thousand more schools were ready to tune in compared with the number twelve months before. The total number registered at the end of July was 27,697. Three-quarters of all the schools in the United Kingdom now listen to one or more of the broadcasts each week.

## BBC Appointment

THE BBC has announced the appointment of Mr. H. F. Bowden as Engineer-in-Charge of the S.W. transmitting station at Skelton, Cumberland, following the retirement of Mr. S. A. Williams, M.B.E.

Mr. Bowden joined the Corporation in January, 1926, as an Assistant Maintenance Engineer in London.

## Under Consideration

IT is reported that the Government of India may install a 50 kW transmitter at the Nagpur station of *All India Radio*.

Reception at present of programmes transmitted from Nagpur is far from good in several areas.

## Frequent Visitor

ONE of the visitors to this year's Radio Show came up from Devon and made three trips to Earls Court to see the H.M.V. Hall of Sound.



This man with the strange occupation caused passers-by to stop and stare in Trafalgar Square recently. He is an employee of the Metropolitan Water Board and was using an acoustic apparatus to trace a water main under the pavement.

He then returned home to Devon only to journey back to London with his wife and child for yet another look at the exhibition, making four visits in all.

#### From Russia, Too

ALSO included in the thousands of visitors to the show was a delegation of Russians, headed by Mr. S. A. Ivanovitch, deputy minister of Radio Technical Industry, U.S.S.R.

#### Ferguson's New Director

MR. S. T. HOLMES, publicity manager for Thorn Electrical, has been appointed as a director of Ferguson Radio Corporation Ltd.

#### Canadian Station in France

A SIX-MAN team of Canadian airmen, based at Number Two Fighter Wing in France, gives a 24-hour listening service to Canadians and their families.

A large stock of records, transcriptions and plays is always kept in hand and request recordings by telephone are also played by the station operators.

#### Obituary

MR. HAROLD LISTER KIRKE, C.B.E., M.I.E.E., formerly Assistant Chief Engineer of the BBC, died in London on August 25th at the age of 60.

In 1924 he joined the BBC, becoming in the following year Head of what was later known as the Research Department. From 1950 until he retired through illness two years later, he was Assistant Chief Engineer. He was appointed C. B. E. in 1947.



Mr. H. L. Kirke, C.B.E.

His study of the problems involved in V.H.F. broadcasting was specially valuable and led to the BBC's decision to adopt the system.

#### Storm Warning

AN Ekco "radar eye" that can see dangerous storm clouds from a distance of 120 miles will be fitted to the B.O.A.C. fleet of Bristol Britannias. They will be the first British airliners capable of "seeing" their own way through the cumulo-nimbus storm clouds

that gather on air routes through the tropics.

#### Aircraft Announcement System

AMONG the interesting features exhibited at Farnborough Air Display this year was an aircraft passenger announcement system, which is reputed to be the lightest and most flexible in the world.

The heaviest item is the amplifier which weighs 12 lbs. Each individual seat is fitted with a pillow-phone unit.

#### Radio Installation

THE new 6,600-ton newsprint carrier *Sarah Bowater* has been fitted with radio communication and navigational aid equipment by members of the technical staff of the Glasgow depot of the Marconi International Marine Communication Co., Ltd.

Long-range speech and morse communication will be provided by a bench-mounted "Oceanspan" telegraphy-telephony transmitter working in conjunction with "Mercury" and "Electra" receivers.

#### Secretary's Retirement

MR. F. W. HOLLINGS has retired from his position as secretary of the Dubilier Condenser Co., Ltd., and has now been appointed a director of the company by the board of directors. Mr. H. S. Clemow has taken over as secretary.

#### J. B. Priestley Festival

THE BBC is to broadcast a festival of plays by J. B. Priestley in the Light Programme this autumn in the "Curtain Up" series.

The series will include "Dangerous Corner" on October 26th, "I Have Been Here Before" on November 2nd, "When We Are Married" on November 9th, "An Inspector Calls" on November

16th, "The Linden Tree" on November 23rd and "The Golden Entry" on November 30th. "Angel Pavement" is to be presented in eight 30-minute episodes on Thursday at 8 p.m. commencing October 27th.

#### In Miniature

A TRANSISTOR midget receiver has been demonstrated in America which weighs no more than 6.4 ounces and is no larger than a packet of cigarettes.



Disc-jockey L.A.C. Jim Simundson, of Winnipeg, at the microphone, and Sgt. Stewart Smith, of Ottawa, taking their turn in keeping the radio-station "on the air." (See "Canadian Station in France.")

It can be operated either with a miniature earphone, with a matching speaker about its own size, or fitted into an ashtray base with a large speaker and powered by A.C.

#### Regular Songsters

MANY popular vocalists are to be heard regularly for the next few months on the Light Programme each weekday evening.

They include Eve Boswell, Vera Lynn, Frankie Vaughan, Jimmy Young, Ronnie Hilton, Ray Burns, Joan Regan and Pattie Lewis. Each will have a 25-minute programme from Monday to Friday beginning at 6 p.m.

# A 3-STAGE TRANSISTOR RECEIVER

By Capt. R. F. Graham

**T**HIS is the simplest practical one-battery receiver. The unique arrangement of a diode directly coupled to a transistor, which is also directly coupled to another transistor in cascade and in the simplest possible manner, dispenses with many components, matching problems and all other inefficiencies. Without transformers fidelity is improved. Volume is greater, due to good matching, and can be easily doubled by using two matched transistors in parallel for output. Sensitivity is also greatly improved by wider separation between coils, and if a third tuned coil is used it is almost as good as any small mains superhet with one I.F. valve sold on the market.

## Basic Circuit (Fig. 1)

With a suitable aerial, components and earth, this basic circuit will work, but additional refinements improve reception.

Diode D has its cathode K connected to the aerial end of the tuned coil. Only the negative R.F. half-cycles of the carrier wave are allowed to pass through to the base b of the first transistor Tr1. This is very important and is explained later on. Transistors are of the junction p-n-p type, which means that the baseplate, which separates collector from emitter, is made from a negative type of germanium; b1, therefore, accepts the negative half-cycles passed by K, which is also made from a negative type of germanium, and this end of the diode is painted red; the anode end, a, is not painted.

Input to Tr1 is from the coil and the power is shared from the aerial, both voltage and current. A high Q coil produces a substantial potential difference at each end when tuned by a capacitor in parallel. During half a cycle of a radio frequency carrier wave,

when the aerial end A is negative and the E end is positive, electrons flow through D to b1 which is in contact with e1 connected to E. During the following half-cycle K does not accept the positive half-cycles and so a small negative bias accumulates at b1 and is not destroyed, or cancelled out, by the positive ones. If the diode is removed or shorted or a very small capacitor is fixed across it to allow a portion of the positive half-cycles to reach b1, then they neutralise bias and the output falls very considerably. Another transistor was tried in place of the diode, using only the b to e section and then only b to c section; in both cases it proved to be a very poor rectifier.

The output from Tr1 is between c1 and e1; there are only three leads from a transistor, so the emitter e1 is common to both input and output. Power supply for output is adequately supplied by the battery. Whenever a very small  $\mu$ A current from the coil passes from b1 to e1, then b1 allows a considerably larger current to flow through it. Electrons flow from the battery negative through R to c1, through b1 to e1, completing the circuit at battery positive. The amount of battery current b1 allows to pass through it depends upon the amount of input current passing through at that instant. The output is in definite proportion to input.

The resistor R is the output load for Tr1; it is also the input to Tr2. Furthermore, since it connects b2 to battery (-), while e2 is connected to (+), it acts as a bias supply. R must have a high resistance so that there is sufficient voltage drop in it and bias input to Tr2 is not excessive, but just sufficient for Tr2 to function on the steep, straightest part of its characteristic curve, while Tr1 works on the low slope.

Broadcast carriers are usually modulated with audio-frequencies to less than 80 per cent.; that leaves more than 20 per cent. steady bias for Tr1 and is quite sufficient. Since very many R.F. half-cycles pass through D for each half-cycle of audio modulation, the bias at b1 will modulate or increase and decrease at the same audio frequencies, and Tr1 will amplify this kind of input to b1 and will produce larger voltage changes at c1: R being a high resistance prevents these audio signals from being shorted to battery. R acts in the same way as a resistance capacity coupling between two valves, except that there is no capacitor. This direct coupling produces far better fidelity, the audio bass notes are full and rich. It is, in fact, a D.C. amplifier capable

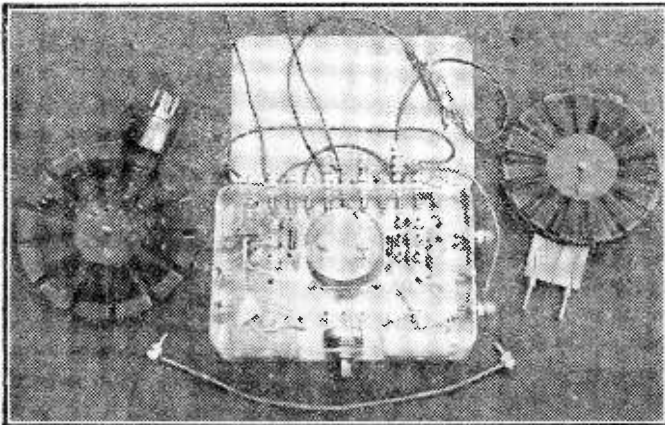

The three-stage transistor receiver described in this article.



of faithfully reproducing the whole of the audio range and much more.

Input to Tr2 derives its current from the battery and voltage from c1 for audio and voltage from battery for bias. When c1 is more negative, b2 receives more electrons which flow from b2 to e2, and so, as in the previous case of Tr1, now Tr2 amplifies the output from Tr1 and the amplification now is ever so much greater. Electrons flow from battery (-) through the transformer T primary p to c2 through b2 to e2, completing the circuit at battery positive. Audio signals in the transformer are passed on from p to s by induction in the usual way and so on to the loudspeaker.

### The Receiver Circuit (Fig. 2)

In this circuit C2, L2, C5, Tr3, R3 and C6 may be omitted, and L1 need not be tapped for long waves.

However, much better results will be obtained if the aerial coil L1 is tapped at every turn for the higher frequencies of the medium band and at least half-way from earthed end for the short waves. If the coil is tapped, then C5 is not necessary, but if it is not tapped, then C5 is strongly recommended for best optimum results by tuning both C1 and C5. Short waves require less C5 capacitance down to minimum capacity and fully meshed plates or C5 shorted for long waves. This depends on the length and height of the aerial.

The tuned absorption coil, or wavetramp L2, collects power from L1 and in the same way L3 collects from L2. Since L2 is free from any connections, it builds up high potentials and effectively prevents nearby higher and lower frequencies from passing through from L1 to L3. Its position is midway between L1 and L3. There is surprisingly little loss in using this extra coil, and this insignificant loss is greatly compensated for by excellent selectivity and freedom from interfering stations. The tuning is very critical, nothing can be heard until all three coils are nearly dead on the frequency. When a station is found, dial readings should be noted down. When hunting for new stations reduce C2 capacitance to minimum and do not use coil L2 but tune in L1 and L3 close together,

then tune L2 and move the coils further apart.

Diode coil L3 is not connected to the earth lead. The receiver, being sensitive, picks up mains hum from the earth lead and other interferences.

The aerial coil and wavetramp coil are movable so that all coils may be suitably spaced apart. This is necessary for attenuating strong signals to the correct low level input. Separating coils further apart improves selectivity. L1 is 11in. away from L3 when

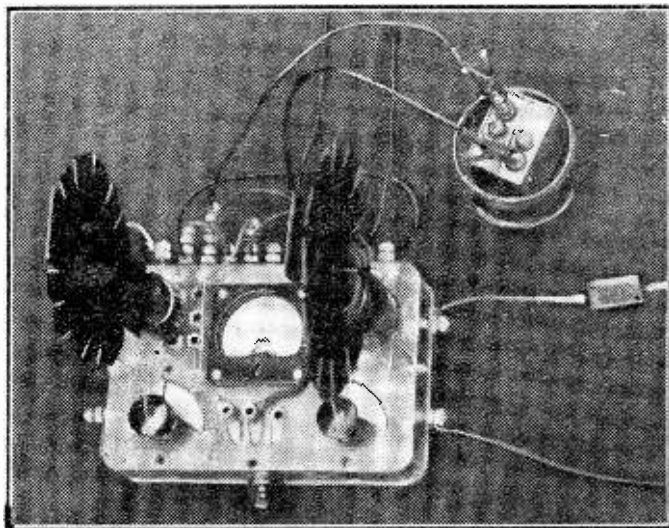

Another view of the receiver.

BBC Home Station is tuned in on an indoor aerial in Bedford, with L2 in the middle. (See photo: simple pancake coils are used and suffice.)

GD3 diode is used, but a more suitable type would be still better; it is connected to the top of the coil for more sensitivity to weak signals. A tap is better for strong signals, but strong signals must be attenuated to be heard on this receiver; this paradox will be explained later.

Owing to diode resistance the first transistor is OC70, because it has less leakage current and the battery is 3 volts.

A 0.001  $\mu$ F capacitor C4 suffices to bypass stray R.F. and any supersonic heterodyned frequencies which would interfere with the proper working of OC70 transistor. At the same time, it builds up a small negative bias from a collection of R.F. half-cycles which are smoothed out, leaving the audio-frequency modulations unaffected. There appears to be no noticeable loss of audio high-frequencies and so they are not bypassed.

The multi-functional resistor is shown as R1 variable 100,000 ohms, in series with R2 fixed 20,000 ohms, to prevent applying excessive bias, which when fitted makes the receiver foolproof and safe for a friend to try it out. If a 4-volt accumulator is used, increase the safety resistor to 35 k, or for a 2-volt accumulator 15 k to 20 k, and for 1½ volts down to 10 k; 2 to 3 volts is recommended with 25 k to 20 k safety R2.

With aerial disconnected or coil L3 shorted, R1 should be adjusted for a meter reading of 3 mA for loud reception or 2 mA for not so loud. The aerial

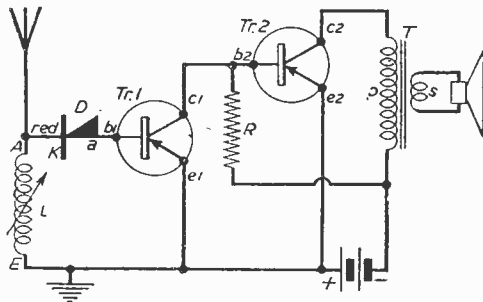

Fig. 1.—The basic circuit.

is then connected and as a station is tuned in meter readings will drop. If reading drops to less than 1.5 mA the coils are too close. If the reading does not drop down to 1.5 mA then the coils are too far apart or the aerial signal is too weak. For weak stations adjust R1 for a reading of 2 mA and coils for as near to 1.5 mA as possible. Best results are roughly between 1.6 and 1.4 mA when one output transistor is used and double this for two transistors in parallel. R1 is then adjusted for a meter reading

of L2 in micro henries can be calculated or obtained from an abac. C2 should also be calibrated or curves plotted for each L2 coil showing R.F. in kilocycles at C2 readings, then the receiver becomes a frequency meter with an accuracy depending upon calibrations which can be very good. Any station on medium, long and short waveband can then be more easily tuned in, using all the three coils simultaneously.

Long wave coils may consist of a sandwich of two pancake coils, identical and in series, with insulation

between. They are easy to wind and Q is quite good enough. Since thinner wire is better more slots make a neater job, but for short waves fewer slots suffice. In all cases slots should be sufficiently wide not to kink the wire or scrape enamel off; an easy snaky wave in and out of slots is best. One shorted turn in a coil is fatal. Starting with a 2in. inner diameter wind 48 turns of 24 s.w.g. enamelled wire for a 181  $\mu$ H coil to cover the medium band with a .0003 mF tuning capacitor. A 4½in. diameter disc should have 13 slots 3/16in. wide evenly spaced around. The long wave coils should be wound with 30 s.w.g. enamelled wire 82 turns on each disc with 15 radial slots 3/16in. wide, two such coils with a plain disc between make a long-wave coil when connected in series. Both coils are wound identically and the outside turn of one is

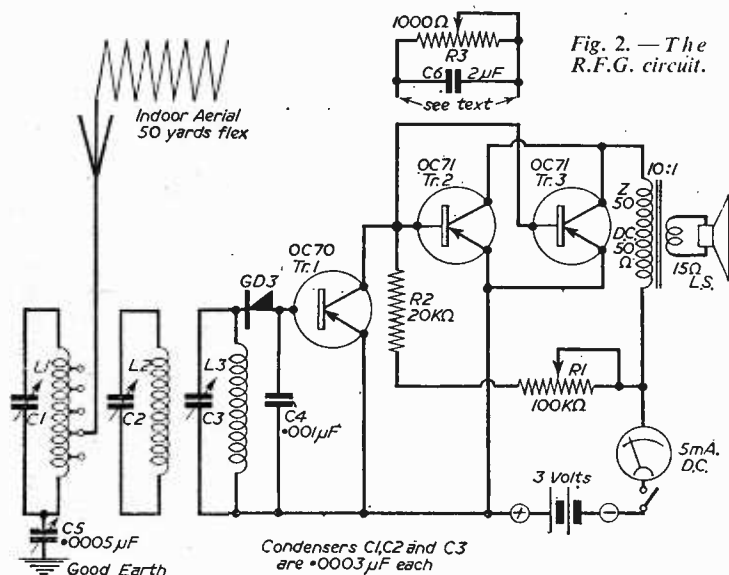

Fig. 2. — The R.F.G. circuit.

of 5 mA with aerial off. These adjustments provide a correct bias for output transistors to work on the best part of the steep curve. Too strong a signal produces a higher potential at c1 and b2 reducing bias and meter readings drop. Therefore output transistors cannot be overloaded. Safety fuses are not necessary.

For maximum volume with two well-matched output transistors, use a 10 mA meter, adjust R1 for a little less than maker's maximum permissible 4 mA per transistor, total 8 mA and place coils for meter reading to drop to between 4 and 4.5 mA.

If output transistors match reasonably well R3 and C6 for audio signals are not required, but if one amplifies appreciably more than this better one can have an adjustable high resistance of about 1,000 ohms connected to the base and adjusted so that output due to less bias is reduced to the same as the other transistor. If this R3 can be dispensed with, so much the better.

The meter has many uses. It acts as a splendid tuning indicator and correct distance between coils could not be judged without it, and correct bias could not be applied. If a tap for the diode is preferred, maximum dip of the meter readings will indicate the best turn on the coil L3. A coil with the best type of construction and highest Q will produce the greatest dip on the meter; the quality of a coil may thus be judged. Even hand-capacity effects are clearly shown.

If C2 is accurately calibrated in  $\mu$ F and a known frequency station is accurately tuned, then the value

connected to the inside turn of the other, and all turns going the same way round from start to finish, clockwise or anti-clockwise. Discs for short-wave coils may be the same as for medium, but with 14 turns 24 or 20 s.w.g. or 20 turns if an overlap with medium-wave coils is desired. For still shorter or megacycle frequencies fewer turns spaced out into notches at sides of 11 or nine slots and about six to eight turns will bring in quite a number of stations. If aerial coils are not tapped they should have fewer turns depending upon aerial used.

#### Inefficient Items

The output transformer and speaker are the inefficient items and should be the best obtainable to appreciate quality and volume. A home-made horn speaker with a sensitive moving coil in a very large magnet was made to fit into a corner of a room so that the corner at the ceiling and side-walls form the continuation of the horn into the room, and this effort proved to be worth while. The moving coil should move freely for reproducing good quality bass at small wattage. A couple of condenser speakers with crossover should be excellent. The primary winding of the transformer must have as low D.C. resistance as possible, 50 ohms or less and certainly not more than 100 ohms, and 50Z high impedance so that the transformer can reproduce all the audio range output to the speaker. That means a large transformer with a fair cross-section of best laminations.

# Servicing Radio Receivers

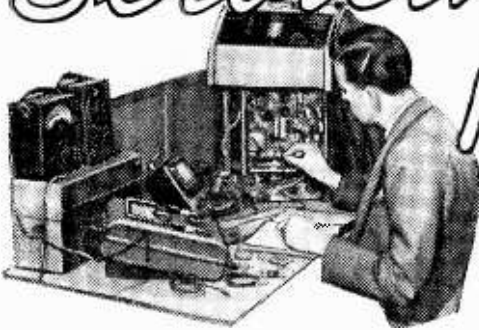

## 6.—EVER READY MODEL "C"

By Gordon J. King, A.M.I.P.R.E.

### General

THIS is another one of those popular "all-dry" battery portables which has developed through several stages.

Its circuit, as may be seen at Fig. 1, is relatively straightforward, being in the form of a four-valve two-band superhet. Signal pick-up is by two internally mounted frame aeri-als; L1 for medium-wave, and L2 in series for long-wave.

### The Circuit

It will be noticed that the model described employs the older style octal type "all-dry" valves (i.e., the 32, 33 and 35 range), while the current model, with few modifications, features the all-glass type miniature valve.

Switches S1A and S1B serve to select the appropri-

ate frame aerial and oscillator coils; both switches being in the closed position on medium-wave. These switches, together with the on/off switches—S2A and S2B—form a wafer type switch, providing three positions—viz. medium, off and long.

The pentagrid frequency-changer valve V1 (DK32) is in receipt of two signals; one, the incoming signal tuned by C1 section of the gang, and two, the oscillator signal tuned by C2 section of the gang. This produces a 452 kc/s I.F. signal in the anode circuit.

The oscillator itself takes the form of a tuned grid arrangement, coils L5 and L6 providing the required amount of feedback. On long-wave both grid coils L3 and L4 are in circuit, but on medium-wave coil L4 is shorted by S1B.

From the first I.F. transformer (I.F.T.1) the I.F. signal is amplified by V2 (DF33), and applied from the secondary of the second I.F. transformer (I.F.T.2) to the signal diode in V3 (DAC32).

This diode is used for signal demodulation and also A.V.C. The rectified signal is filtered by R1, C3 and

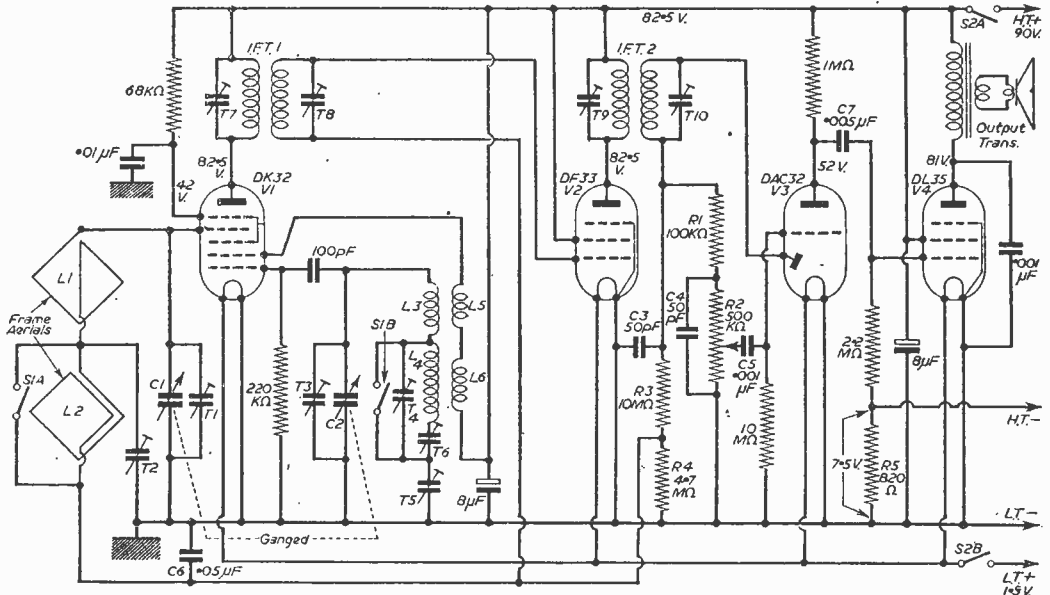

Fig. 1.—Circuit diagram of the Ever Ready Model "C" portable receiver.

C4, and is developed in A.F. form across the volume control R2, which virtually forms the detector load. The position of the volume control thus determines the level of A.F. applied to the grid of V3 triode.

Only that part of rectified signal as developed across R4 of the potential divider R3 R4 is used for A.V.C. bias. As will be seen, the resulting direct voltage is filtered by C6 and used as bias for V1—through L2 and L1—and V2—through the secondary of I.F.T.1. As is well known, the magnitude of this voltage, which is negative relative to chassis, is dependent on the input signal, so that as the signal rises the negative voltage increases and reduces the gain of V1 and V2 correspondingly—the converse also occurs.

A factor which may give rise to severe distortion and consequent damage to the output valve, is C7 becoming leaky (possessing resistance). An insulation resistance as high as 20 megohms is sufficient to disturb severely the operation of V4, owing to its relatively high input impedance (resistance).

The value of the anode resistor of V3 may also rise. This is not always so readily noticed unless it goes completely open-circuit.

An eye should also be kept on the value of R5, and this should come under suspicion if the distortion content seems higher than normal. We would mention that the volts-drop across R5 will increase if C7 turns into a resistor, since V4 will then be passing more than normal current.

Valve microphony in this type of receiver tends to become rather disconcerting at times, particularly after the valves have been in use for several years. The only real solution to this problem lies in replacing the valve(s) responsible. It is sometimes feasible to dress-up a microphonic valve to prevent it being directly affected by sound waves from the loudspeaker. Soft rubber or cotton-wool does sometimes help in this respect, though a lot of the provoking vibration is transmitted through the chassis and valve holder, and it is not generally worth while to float the associated valve holder on soft rubber bushes.

As the valves age, conditions for microphony are somewhat aggravated by a running-down L.T. section. The disturbance appears to build up to a peak just before the battery is finally exhausted; on replacing the battery the effect is hardly noticeable.

If it is found that the receiver cuts-off dead before the battery has provided its expected lease of life, the trouble may be due to a low emission DK32. Substituting the valve while using the original battery will prove this point. The trouble is caused by cessation of oscillation, and if replacing the valve is not successful the oscillator grid capacitor and resistor should be checked.

Although the combined H.T./L.T. battery is designed to provide approximately equal life of both sections when used with this receiver, it sometimes happens that the L.T. section voltage falls below that required to sustain oscillation in the frequency-changer stage. If this occurs the H.T. section may be drained completely by employing a separate 1.5 volt L.T. battery of the "all-dry" variety. This modification simply involves removing the L.T. leads from the 4-way battery plug and resoldering them to a 2-way plug suitable for the L.T. battery used.

It will, of course, be necessary to use the extra L.T. battery outside the cabinet. A permanent modification could be made so that separate L.T. and H.T. batteries may be housed within the cabinet, but this will demand the selection of batteries of suitable size.

The chassis unit complete with frame aerials may be removed from the plastic cabinet by first removing the control knobs, and then removing the four wood screws which hold the chassis to the wooden slats on the side of the cabinet.

The chassis should be withdrawn by grasping the speaker transformer clamping strip, and arranging for the bottom of the frame aerial to leave the cabinet first.

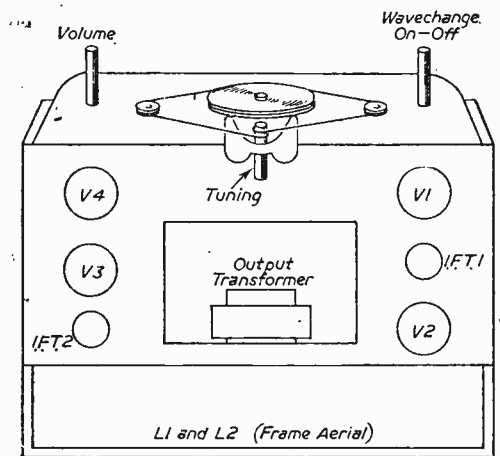
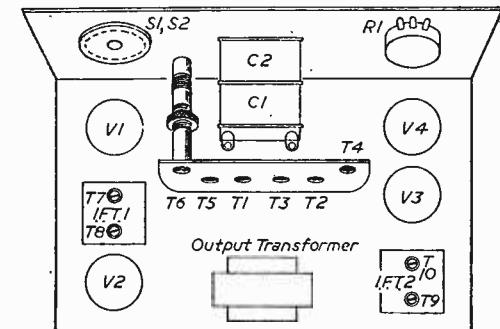

Fig. 2 (above).—Top view of the chassis. Fig. 3 (below).—Under-chassis view showing the tuning drive.

The amplified A.F. at V3 anode is taken by way of C7 to the signal grid of the output valve V4 (DL35). This valve provides approximately 240 mW. output in its anode, and is biased by the 7.5 volts developed across the auto-bias resistor R5.

**Servicing Notes**

Like all "all-dry" battery receivers, this model uses relatively large value resistors in the anode and grid circuits of the A.F. valves (i.e., note the 10 megohm resistor in the V3 grid circuit).

**Alignment Procedure**

It is desirable to align visually by connecting a sensitive A.C. voltmeter across the primary of the

(Continued on page 676)

# Using TEST INSTRUMENTS



Part 11 of a Series of Articles  
Dealing with the Practical Application  
of Standard Test Equipment



(Continued from page 637 October issue)

LET us suppose that it is required to calibrate an audio oscillator, then the output of the oscillator is connected to the "Y" plates of the 'scope and a standard frequency, say, the 50 c.p.s. mains, is connected to the "X" plates. Now, as the unknown frequency is varied, the trace on the screen will pass through a succession of complex shapes, but a simple pattern will result each time a simple multiple occurs, and it is a simple matter to determine the frequency of the generator simply by counting the peaks of the resulting waveform. The intermediate multiples, such as 3 to 2 and 4 to 3, are more difficult to determine, and may bewilder more than assist the experimenter.

We have shown that by applying a standard frequency—such as the 50 c.p.s. mains—to the "X" plates of a 'scope, with the timebase disconnected, and an unknown frequency, such as the output of an uncalibrated audio oscillator, to the "Y" plates, varying the unknown frequency would result in a succession of complex shapes (Lissajous' figures) on the screen.

We further saw that simple patterns recurred each time a simple multiple of the two frequencies occurred and that the peaks of these patterns could be counted and the frequency ratio between the two signals readily computed.

The patterns in Fig. 43 occur as the result of simple multiples from 2 : 1 to 6 : 1, meaning that the unknown frequency—assuming the standard frequency to be 50 c.p.s. mains—has been shifted from 100 to 300 c.p.s. It is possible generally to count frequency multiples of as high as 10 : 1. The intermediate multiples, however, are more difficult to determine.

For the sake of completeness, intermediate multiples in the ratios of 3 : 2 to 6 : 4 are illustrated at Fig. 44. One of the best methods of ascertaining the ratio of an intermediate multiple is by counting the number of peaks on the figure and dividing this number by 1 plus the number of horizontal intersections. In order to make this clearer, let us consider first the pattern in the ratio of 3 : 2. It will be seen that this has three peaks, and that each loop or waveform intersects along a single horizontal line, thereby revealing a ratio of 3 : 1 + 1 (3 : 2). Now let us consider the

pattern in the ratio of 6 : 4 : here we can count 6 peaks and three horizontal intersections—one at the top, one at the bottom and one in the centre of the pattern—we can thus compute the ratio of 6 : 3 + 1 (6 : 4).

## Synchronism (37)

When we require to examine a waveform in the normal way by using the timebase in the 'scope, it is often desirable to prevent the display from moving slowly across the screen, as does occur when the observation signal is not quite in step with the timebase. It is, of course, possible to adjust very carefully the timebase repetition frequency by means of the "fine" adjustment, but it is impracticable to hold the two frequencies in step by this means for any length of time.

It can be done quite automatically, however, simply by introducing a small ratio of the voltage under examination to the t.b. generator. The effect of locking the frequency of the t.b. to that of the examination voltage will thus be achieved, thereby enabling one or more stationary waveforms to appear on the screen, depending on the ratio between the two frequencies.

On most 'scopes the sync voltage is generally applied by connecting an external link from the "Y" plate terminal to an adjacent terminal marked "sync input." A potentiometer marked "sync control" is also generally fitted to enable an optimum ratio of signal voltage to be applied to the t.b. for synchronising purposes. On some instruments a switch is fitted to this control as a means of facilitating connection of the synchronising voltage to the t.b. When this feature is incorporated it is not necessary, of course, to make an external connection to the "sync" terminal.

Too small an amplitude of sync voltage will not produce the desired effect of locking the waveform on the screen, while on the other hand too much sync will reduce the horizontal amplitude of the trace, and if the timebase is set originally to show a number of waves on the screen an increase in synchronism will cause the waves to be cut off one after the other until

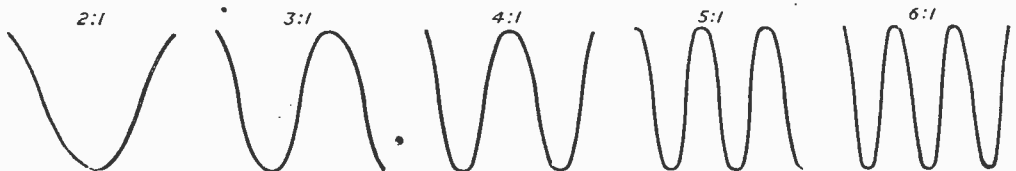

Fig. 43.—Oscillograms as the result of simple frequency.

finally they diminish to one wave or perhaps even a fraction of a wave. Excessive synchronism may also provoke a single wave suddenly to jump into a double one, the second one being displaced from the original as shown in Fig. 45.

After applying a synchronising voltage to the t.b. it is often desirable to readjust the "fine" t.b. control and if necessary reduce the sync voltage, for the sync control should always be maintained at the position providing "light" locking of the waveform.

### Deflection Amplifier (38)

As a normal C.R.T. usually requires 20 to 100 volts R.M.S. for full screen deflection, it is customary to employ a deflection amplifier connected between the examination voltage and the "Y" plates when voltages of small amplitude need to be investigated. An amplifier (or amplifiers) of this nature is built into most commercial oscilloscopes. Their overall gain is adjustable, usually by means of a rotary decade attenuator switch and a continuously variable attenuator which provides an adjustment of gain from zero to the maximum selected by the decade switch.

Sometimes a two-position attenuator switch, together with a continuously variable gain control, provides the function of amplifier control. As it is desirable for the amplifier to possess a substantially flat frequency response from a little above D.C. to, at least, 100,000 c.p.s. for certain application, and above this figure for others, a number of commercial instruments have two positions on the attenuator switch, one giving a high gain with a limited response, and the other a limited gain and an extended response.

Since transient waveforms, such as square waves, etc., are made up of a wide spectrum of frequencies from D.C. upwards, they can be displayed on the screen in their true form only by faithful amplification. For instance, if the deflection amplifier has a poor high-frequency response a pure square-wave would appear to have rounded corners.

Similarly, a poor high-frequency response would be liable seriously to distort the trace of a line sync pulse and a line sawtooth waveform, while, conversely, a poor low-frequency response may have the effect of distorting the display of a frame sawtooth waveform, thereby rendering the instrument of little practical use for linearity and similar checks on a TV receiver.

If it is discovered that the internal amplifier in any particular 'scope does not come up to the required standard for an exacting test it is possible to switch out the internal amplifier and in its place employ an external amplifier of more exacting design—such an

amplifier should follow after the style of the video-frequency stage used in television receivers.

### General Applications (39)

We should by now have some idea of the basic applications of the oscilloscope, though it should be mentioned that its versatility is dependent to a considerable extent on the skill of the operator in making the tests, and the operator's knowledge of the particular instrument he is using. If a commercial 'scope is used the very simplest of tests should first be made, and each test fully assimilated before going on to perform tests of a more advanced nature. The operating booklet of the instrument should also be fully perused, and careful study of the circuit will help in acquiring the maximum benefit from displays resulting from the more complex applications. For example, the connection of a 'scope to certain circuits may be liable to cause secondary disturbances in the circuit under test. An illustration in this respect occurs when a 'scope is used to check the timebase section of a TV receiver. Interaction between the instrument timebase and the synchronising network of the receiver often results if the synchronising voltage for the 'scope represents a portion of the actual examination voltage.

Usually, for a test of this kind it is necessary to use the deflection amplifier, in which case the amplifier can be used to perform the function of a buffer by synchronising the display from a portion of the examination voltage appearing at the *output* of the deflection amplifier.

A study of the timebase and synchronising circuits of the oscilloscope would reveal that a pulse voltage occurs on the "sync" terminal during the flyback period of the timebase, and it is this spurious voltage which, in this particular case, is liable to incite interaction between the instrument and the TV receiver.

Other secondary effects may result when the 'scope is used in A.F. applications, but they can generally be interpreted, and thus accounted for, once the operator is familiar with the operation and the circuit of his instrument. It can be said that the advantages yielded by the 'scope rise sharply as the operator gains experience in its use.

### Applications at A.F. (40)

The real advantage of the oscilloscope is that of being able to see what exactly is happening in a signal carrying circuit without subjecting the circuit to an excessive load and thereby disturbing its normal operating conditions. *(To be continued)*

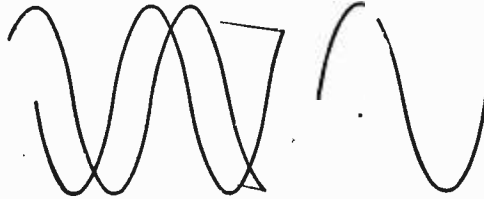

Fig. 45 (left).—An illustration of the effect of too much sync. Fig. 46 (right).—A pure sine wave.

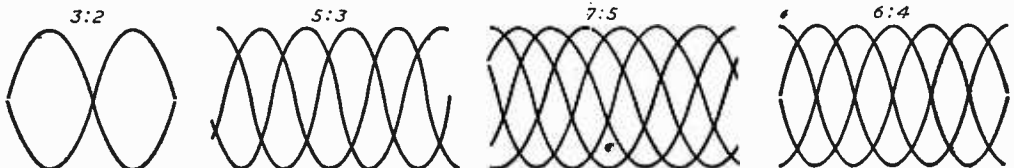

Fig. 44.—Oscillograms of some intermediate multiples.

# THE NATIONAL RADIO SHOW

A SUMMARY OF THE  
MAIN FEATURES AND  
TRENDS AT THIS  
YEAR'S EXHIBITION AT  
EARLS COURT

By

Lord Donegall

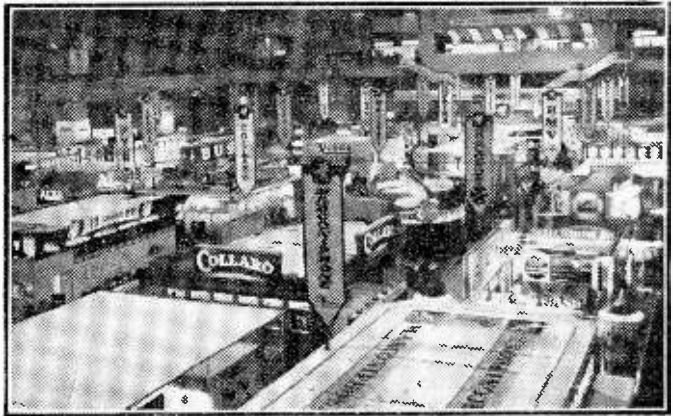

*A general view of the Show.*

**T**HE twenty-second National Radio and Television Exhibition at Earls Court was opened, after Herculean efforts had overcome some labour troubles, on the morning of Friday, August 26th, by the Postmaster General, Doctor Hill.

It was the largest and most comprehensive ever put on by the rapidly expanding British radio industry. The industry gave very careful thought to and studied the available statistics relating to the trends of our listening and viewing habits.

For instance, several comparatively unknown factors presented themselves to the industry. Neither Commercial Television nor V.H.F. has, as yet, been extensively "tried out on the dog." To what degree they would affect the sales of ordinary "steam radio" sets was a matter for deduction. Size of screens was easy, the public had been going for bigger screens, so the 17in. begins to outnumber the 14in., which was the most popular last year.

The Industry's third imponderable was to assess the rate at which the public's thirst for higher fidelity of reproduction will grow.

## A General Investigation

Let us take a general look at the Show and see if we can gauge how the industry, as a whole, has attempted to find a solution to these problems. It may seem surprising that, with V.H.F. unobtainable in the greater part of the country, sets with V.H.F.

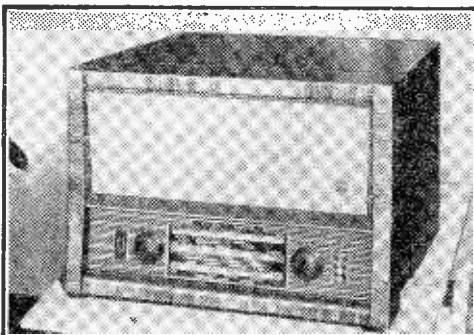

*The Ekco TRG252 table auto-radiogram which provides for V.H.F. reception.*

Band should be the order of the day. I expect that the manufacturers sought to standardise production. Another reason for the table model suddenly sprouting V.H.F. may be that it needed a hypodermic to keep it alive at all. Not so with the portables and the prettier models. They still scorn V.H.F. as though it did not exist. At the same time, the short wave band tends to disappear, as will, eventually, the ordinary medium and long wave bands on which we are to rely, for the present, for our foreign broadcasts. Many of the new sets fitted with V.H.F. do not cater for the maniac who likes to listen to America at 4 a.m. (we usually have a special set for the purpose, anyway).

English Electric were, I think, the pioneers in the idea of making TV sets capable of receiving V.H.F. sound broadcasts. Both Decca and Ekco have now cottoned on to the idea, as I discovered when I ordered an Ekco portable TV for my car. This is the first true portable TV set to appear on the British market. It has a 9in. screen and plugs into the mains or a car battery.

F.M./A.M. radiograms were far more plentiful than similar table radios. Perhaps the reason for this is the presumption that anybody who insists on high fidelity is a music fan and, therefore, will want to play records.

## Larger Screens

In mid-1950 television accounted for only three per cent. of all the licences, whereas at the present time one licence in every three is for television. Although the 17in. screen held the fort at this year's Show, makers who showed 21in. screens included Alba, Bush, Baird, Dynatron, Ekco, English Electric, Ferguson, G.E.C., Kolster-Brande, Masteradio, Philips and Pilot. The largest television tube in the Show was the rectangular 27in. Ediswan.

Improvements which seemed to be common to all models included better focus with less astigmatism. These results were due to better magnetic focus units or from the introduction of electrostatic focus as exemplified by H.M.V. and K-B. Nearly all tubes now have the ion trap that prolongs life and some had,

in addition, aluminised screens to improve brilliance and contrast.

So far as prices were concerned, typical 14in. table sets cost around £70 and 17in. around £80. The straight 17in. console was priced around £93; more fancy cabinets averaged around £110. Nearly every maker of TV sets showed converters to enable existing sets to receive the Commercial programmes. Five or six guineas covers the cost for readily convertible sets and 10 guineas for those where the converter has to supply its own power.

The new V.H.F. sets fell into two classes. First, those designed to give programmes at better than ordinary quality, without interference. Secondly, those designed to take full advantage of the wider musical range. The former are mostly around £30, with Corsor, K-B and Ultra a little cheaper. The second category starts at some £40 (Pye) to £50 (Philips). The special speakers essential to spreading the high frequencies all over the room account for the extra cost.

The advent of V.H.F./F.M. has increased the demand for the console radiogram. In this field I was much impressed by the prices of the four-band Regentone at 59 guineas and by the twin-speaker Corsor at 62 guineas.

The combined radiogram-TV is still something of a rarity, but Regentone showed one at 159 guineas. At the other end of the scale the portable electric gramophone was in great demand. Examples are the Regentone "Handy-gram," Philips' "Disc Jockey Major," R.G.D. "Five-O-Five," and the new "Deccalian" and "Portola."

Last year I wrote of H.M.V.'s introduction of tape records for sale to the public. This year H.M.V. took a step forward by introducing us to tape records carrying twin-tracks which, when reproduced through

suitable twin-channel equipment, give the "stereophonic" effect. They were selling a twin console outfit which can also be used for single-track tape records and for discs.

There were many kinds of tape recorders. Tape Recorders (Electronics, Ltd.) had a playback-only machine for use through a radio costing 26 guineas



*A prospective overseas buyer visits the McMichael stand.*

and a complete portable recorder at 35 guineas. Just before the Show, I had delivery of my new Simon portable model SP 2 and am delighted with it. I think I have had all the Simon portables at one time or another and the SP 2 is far in advance of any of the former models. A tape novelty we might mention is the 3in. spool for sending messages to friends which H.M.V. showed at 7s. 6d., complete with greetings card and special pack. There was also the Tape Transcription (Collaro) which has a tape-deck with four "heads." Thus, both tracks can be recorded without turning over the reels.

As in the new Simon, several other tape recorders provided straight-through amplifier facilities to enable records to be played or normal "public address." This applies, for instance, to "Elizabethan" models by E.A.P. (Tape Recorders, Ltd.). The Rudman Darlington "Reflectograph" recorder has a playback amplifier with four transistor stages to eliminate hum. It also has tape speed-control between  $3\frac{3}{4}$  and  $8\frac{1}{2}$  i.p.s. designed to maintain exact pitch despite the vagaries of mains voltage. (What will they think of next?)

#### Television Aerials

Aerials for Bands III (TV) and Band II (V.H.F.) were in great variety. Broadly, there were two categories, those for a single band and those for two bands—and in both there was a choice of indoor and outdoor types, the latter ranging from the simplest possible for strong-signal

*(Continued on page 714)*



*Visitors to the Multicore stand could see sets being made on the spot for the home market.*



**Build this  
HIGH  
QUALITY  
LOW COST  
AMPLIFIER**

★ Circuit designed by Mullard research engineers.

★ Specified components available from most radio dealers.

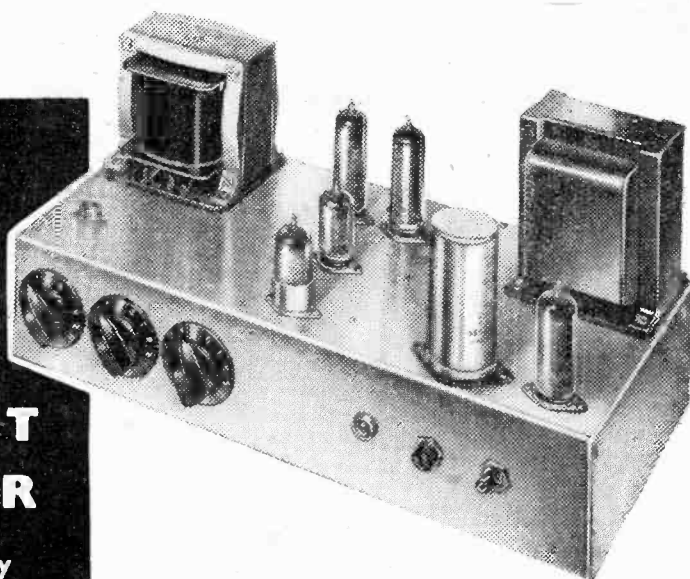

Here's an entirely new amplifier circuit which brings high quality sound reproduction within the reach of thousands more enthusiasts. It has been

designed by Mullard research engineers with special regard for easy construction and low cost.

Full details of the circuit are included in the 2s. 6d. book which is obtainable from radio dealers or direct from Mullard Ltd. Valve Sales Department—2s. 10d. post free. Get your copy now.



<b>EASY TO BUILD AT LOW COST</b>	<b>GOOD TRANSIENT RESPONSE</b>	<b>LOW OUTPUT RESISTANCE</b>	<b>LOW HUM AND NOISE</b>
<b>NEGLIGIBLE DISTORTION AT ALL OUTPUT LEVELS</b>	<b>DESIGNED ROUND FIVE MULLARD MASTER VALVES EF86 ECC83 2 x EL84 GZ30 or EZ80</b>		<b>UNIFORM FREQUENCY RESPONSE IN AUDIBLE RANGE</b>



MULLARD LTD., CENTURY HOUSE, SHAFTESBURY AVENUE, LONDON, W.C.2

MVM3c8G

ELECTRICAL ENGINEERS

NOW **YOU** CAN PROFIT FROM THE KNOWLEDGE OF **80** EXPERTS

**NEWNES Practical Electrical Engineering**



This up-to-date and authoritative work has been produced to serve the keen electrical engineer. It is for you—the man who wants to gain a position of responsibility and the high pay that goes with it. To-day the opportunities for electrical engineers are enormous—with highly-paid jobs everywhere for those who have the foresight to equip themselves with the essential knowledge. NEWNES PRACTICAL ELECTRICAL ENGINEERING gives you this knowledge, and covers every facet in a thoroughly practical manner. 80 experts and the big electrical firms have co-operated to help YOU.

This Wealth of Up-to-date Electrical Knowledge comprises:—

- 4 Volumes strongly bound in Maroon cloth. Dealing with: Installation work of all kinds. Instruments, Machines, Equipment, Operation, Maintenance, Repair, Generation, Transmission, Distribution.
- 2,224 Pages of instructive information.
- 2,340 Photographs, diagrams and drawings.
- 24 Special Copyright Data Sheets, containing wanted information.
- 12 Quick-reference Blueprint Charts.
- 1 Strong Chart Case.

**FREE** Newnes Electrical Pocket Book (value 8s. 6d.) Nearly 400 pages. Free to every purchaser of NEWNES PRACTICAL ELECTRICAL ENGINEERING.

**FREE** Two Years' Technical Advisory Service.

POST THE COUPON NOW FOR

**FREE BROCHURE**

George Newnes, Ltd. (Dept. A), 66-69, Great Queen St., London, W.C.2.

Please send me, without cost or obligation, your illustrated brochure of Newnes PRACTICAL ELECTRICAL ENGINEERING and details of the easy monthly subscription payments.

Name .....

Address .....

.....

.....

Occupation..... PEE 39

**Enthusiastic Owners Write:—**

"A most valuable asset something no tradesman should miss."—J.V.L.

"Without doubt a tremendous aid, in modern workshop practice and education."—E.H.C.

"It is impossible to improve it. It is packed full of all the information I require."—G.W.

"I could not wish for anything better."—W.B.W.

MONEY BACK GUARANTEE **DUKE** Tele: GRA 6677 CWO or COD  
621 ROMFORD RD. LONDON, E.12.

**T.V. TUBES—6 Months' Guarantee**

- 14in. Wide Angle now reduced to £7/10/-. Brimar or Mullard. Ins. carr., 15/6. C.W.O.
- 17in. Wide Angle, £12/10/-. Ins. carr., 15/6. C.W.O.
- 12in. Mullard, £5. 6 months' guarantee. Other types 3 months' guarantee. Ins. carr., 15/6. C.W.O.
- 9in. Tubes. We now have a small stock at £3 each, but regret no guarantee with 9in. tubes owing to shortage of supplies. Ins. carr., 15/6. C.W.O.
- T.V. CHASSIS SUPERHET. 97/8. Complete less valves and tube. 3 separate chassis (power, sound and vision, time-base). R.F. E.H.T. Drawing 2/6 or FREE with order. Carr. 5/- London area; 10/- Provinces.
- "DENCO" RADIOGRAM CHASSIS. 67/8. A 5-valve s/het chassis less valves. Famous Turret Coil tuning. 4 w/band. Universal. Post 4/6. Set of 5 valves supplied with chassis if required, 50/- extra (Int. octal).
- RADIOGRAM CHASSIS. 29/9. Including 8in. speaker. 5 valve s/het. 3 w band. A.C. mains, complete less valves. Tested guaranteed. Free drawing with order. Post 4/6. Set of 4 knobs 1/6 extra.
- RADIO CHASSIS. 7/9. A.C. or Universal, s/het, less valves, dial & electrolytics. Otherwise believed to be in working order. Post 3/6.
- TIME BASES. 10/6. Containing scanning coil, focus unit, line trans.; 10 controls, etc. Famous mfr. Drawing FREE. Post 2/6.
- POWER PACK. 29/6. 5KV. E.H.T. 325v.—250 m.a. Smoothed H.T. heaters 6 v., 5 amp., 4 v. 5 amp., 4 v. 5 amp., with extra winding for 2 or 4 v. tubes. Carr., 4/6.
- T.V. SOUND & VISION STRIP. Superhet, 10 valve holders. Post 1/6.
- V.H.F. 1125 RECEIVER. 7/9. Complete with 2 valves. New X.W.D. Post 2/3.
- V.H.F. 24 RECEIVER. 10/6. New X.W.D. Complete with 3 valves. Post 2/3.

**UNIVERSAL CIRCUIT TESTER**

60-500 VOLTS A.C. or D.C.



- Electrical Domestic Appliances
- Motor Armatures
- Sparking Plugs
- Lighting Circuits
- Radio and T.V. Receivers
- Fuses

**4/-**  
Trade Terms on request.

**HARWIN**  
Engineers Ltd.

101-105 NIBTHWAITE ROAD, HARROW, MIDD. Harrow 0381.



# On Your Wavelength

BY THERMION

## Less Gilbert Harding!

THE BBC from its inception has been notorious for its creation of characters noted for extreme views. A man only has to write a successful novel, even though it be a pot-boiler, for the BBC to invite him to give a talk on education, religion or gardening.

We have had a large number of these characters of whom the late Joad was an outstanding example of mental incompetence and puerility, for he was nearly always wrong. He endeavoured to obscure his ineptitude in a quagmire of tangled blather. Older readers of this paper will remember that I found it necessary to correct him on a number of occasions. When I lunched with him I was astonished at his ignorance. His method of dealing with critics was to hector them and shout them down, but on this occasion I made him bite the dust. However, as the BBC seems to regard its main duty to be to provide parlour games, and presumes it is possible for one individual to have profound knowledge on every subject under the sun, as it did with Joad, it is not surprising that it looked round to find another character, who was forthcoming in the form of the voluble Mr. Gilbert Harding, whose motto appears to be "Rudeness is wit." Now whilst Gilbert is doing a Sullivan act I do not complain. When, however, he starts to express views on politics and attacks the British Empire, I certainly refuse to remain silent and he cannot object therefore, having had his say, to me having mine and taking him down a peg or two. A few weeks ago in a programme "Who Said That?" he launched a tirade of abuse against the English, the Irish, the Scots and the Welsh. It would seem that sometime he visited Cyprus, where, he said, "chinless idiots" (the British) lorded it over other people. He said with a sneer that the British there referred to the Cypriots as natives. I do not know whether Mr. Harding feels that that adjective should be expressly reserved for Dover oysters, but it is perfectly correct to refer to Cypriots as natives of Cyprus. When someone wished in the course of the programme to protest, he said with malevolent impudence, "I will not be interrupted" and browbeat his critics into silence. The great oracular Harding continued with his bad tempered circumlocution whilst the rest of those in the programme sat in awed silence looking up at the Master, who went on to declaim and lambast the British Empire.

He described us as a greedy, grasping people, the Empire as an evil thing and expressed the view that the Empire has gone and good riddance to it. From these expressions of opinion, can one deduce the particular political party to which Mr. Harding owns allegiance? He is not competent nor should he be entitled to express an opinion on this subject and to denigrate the British Empire in a programme of entertainment. If he wants to do some tub-thumping, let him go round the hustings at election time, if he dare, and be pelted with tomatoes or bad eggs.

Good riddance to the Empire, and the race which made it possible for odd characters like Mr. Harding to be able to express these views to a large and unseen audience!

Mr. Harding should remember the famous words: "Who stands if England fall?"

In view of his farrago of hate, which seems to be Mr. Harding's speciality, I am not surprised that the *Daily Mail* attacked him, referring to him as "a puss in the corner expert, who strays into wider realms. What he says is heard by millions of people, many of whom might think that his well-known mixture of arrogance and ignorance is the voice of learning. One could not accuse Mr. Harding of being a chinless idiot. He is not chinless. Having been to Cyprus, this Sage of the Telley, this pompous player of parlour games is naturally equipped to deliver a sweeping verdict upon the entire British Empire, a task into which he plunged with testy malevolence. Mr. Harding has that air of unfathomable crudition, often affected by the ill-informed."

This comic turn has often been in trouble for the violence of his views and the sting of his adder fang. I should have thought by this time that the BBC realised that millions who do not take the trouble to complain are not entertained but offended by him. The BBC makes a great mistake in erecting one character as a sort of radio oracle and it is high time that they varied their cast week by week, and curbed the tongues of their speakers, although I know that it is generally accepted that what Gilbert Harding may say is unpredictable—one of the risks I suppose in unscripted programmes. Would it not be wise to "rest" Mr. Harding for a while? There's one thing about Harding—he can certainly give it, but he can't take it. It is my intense regret that I was not in the programme with him, when I would certainly have wiped the floor with him, metaphorically speaking. I hope by this he has learned his lesson, and that he will confine his attention to parlour games.

Of course, it would be extra work for the officials of the BBC to have to find fresh characters every week for their programmes. Having found one who fits their particular formula and estimate of what the public requires, they plug him and rest on their laurels. The individual concerned gains a reputation out of all proportion to his knowledge and experience and he is only dropped when the public are sated with him.

## Fourteen Million Broadcast Licences

OVER 14 million broadcast receiving licences have now been issued, and the figure has grown from a few hundred thousand in 1922. There are signs, however, that "sound" licences will fall as the number of television licences goes up and it is interesting to conjecture as to the year in which TV licences will exactly equal broadcast licences. My guess is that it will be in the year 1958. Eventually, of course, it will be all TV but when that will be is beyond conjecture—probably by the year 1970.

# TRANSMITTING TOPICS

## TOPBAND AERIAL EFFICIENCY

By O. J. Russell, B.Sc.(Hons.), G3BHJ



PREVIOUSLY several of the factors by which the efficiency of topband aeriels may be improved have been discussed. Considerable interest has been aroused by some of the points raised, particularly the revelation that short aeriels may have a radiation efficiency of less than one per cent. unless extreme care is taken in the reduction of earth and coil losses. Moreover, various expedients, such as top capacity loading, centre loading and so on, have been demonstrated for enabling the efficiency to be doubled at least. In fact, by various expedients, the efficiency can be even further increased, almost 10 times in the case of short radiators.

To consider how this can be achieved, it is as well to recapitulate a few aspects of the "short" radiator. From the technical view, the "short" radiator is one whose length is less than a quarter wavelength. As on topband one quarter wavelength is some 130ft. only the fortunate few among city dwellers can

resistance, losses are still high. Of course, a dipole high in the air may be regarded as a large counterpoise and quarter-wave aerial system, but this is an expedient requiring a large space and is impracticable for many amateurs.

As shown previously, the effective value of the earth resistance may be some 10 ohms. This is the value to be expected from an efficient multiple earth system of well spaced earth rods driven some 8ft. to 12ft. into the soil. Also with a *short* aerial so much inductance is required to load it that even a coil of very high Q may have a resistance of 30 ohms or more. A short vertical aerial may have a radiation resistance of less than an ohm. As all these resistances are in series, only about one per cent. of the available R.F. transmitter output may be radiated. In fact, if R RAD is the aerial radiation resistance, RE the earth resistance, and RL the effective loss resistance of the coil, then the percentage of power radiated is

$$\frac{R \text{ RAD}}{R \text{ RAD} + R E + R L} \times 100 \text{ per cent.}$$

This gives a very disappointing answer when calculated for short aeriels, as a glance at the figures for the radiation resistance of short aeriels previously given will indicate.

### An Improvement

The device of "centre" or "end" loading has been described. This does offer the chance of some improvement, as it can double the radiation resistance, although the extra inductance for loading reduces this advantage by virtue of its own loss resistance. However, while the explanation that the wire in the coil "makes up the length of wire needed for a quarter wavelength" is a useful analogy for its operation, this is only an analogy. In fact, the coil tunes the capacity of the wire of the free end of the aerial. Thus, if the coil were located at the extreme tip of the aerial there would be no free end length of wire to provide capacity, and the coil would resonate merely with its own capacity. The contribution towards radiation efficiency would then be negligible. Fig. 3 illustrates the progressive increase in inductance of a loading coil as it is moved from the base to the free end of the aerial. In fact some slight benefit may be derived from a coil at the free end, but this is due to it acting as a distributed capacity. In such a case even more benefit is obtained by short-circuiting the coil, so that it acts as a top-loading cylindrical hat. This, in fact, reveals the benefit obtainable by adding top capacity loading by using wires, skeleton cylinders, planes or even spheres to the short aerial.

There is no mystery why the additional capacity is beneficial. If we double the aerial capacity, we need only a coil of half the original inductance to reach resonance. For the same Q value, this coil will represent only *half* the loss resistance of the original

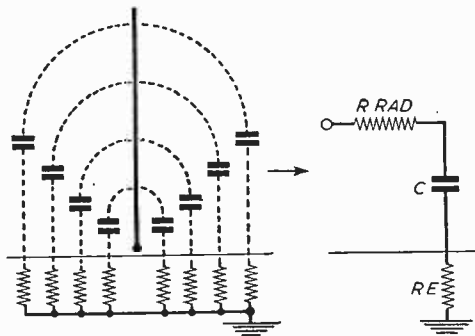

Fig. 1.—The elements of a vertical aerial have a capacity to the earth, which has resistance. The equivalent lumped circuit closely approximating a short vertical aerial is shown on the right. R RAD represents the radiation resistance, RE the effective loss resistance introduced by the ground losses.

achieve anything but a "short" aerial. The equivalent circuit of a "short" aerial may be represented (Fig. 1) as a capacity representing the capacity to earth of the antenna, plus the radiation resistance (R RAD) which accounts for the power radiated, and the earth loss resistance (RE) which represents the power uselessly dissipated in earth losses. In order to tune this arrangement, a base-loading coil must be used. As all practical loading coils have losses, even a high Q coil will add appreciable resistance, so that the power available for the antenna circuit is shared between earth losses, coil losses and the radiation resistance. Even the use of a counterpoise does not eliminate earth losses, as the counterpoise has a high capacity to ground, which means that in fact R.F. circulates in the soil and due to the soil

larger coil. If coil losses are greater than earth losses this will result in almost a doubling of radiation efficiency. Further increases in aerial capacity will result in further gains of efficiency, until coil size—and hence coil losses—reaches the point where the earth resistance becomes the predominating factor.

As even 100ft. represents a "short" aerial on topband, this represents an important factor to those who are able to erect only small aerials due to space restrictions. In the case of mobile operation now becoming an important feature of R.A.E.N. exercises, these factors are absolutely paramount. The vital part played by coil losses in fact reduces the proportion of power radiated, so that a 10 watt transmitter may be reduced to a worse output than a transistor transmitter. The efficiency obtainable may sink, in fact, to as low as 0.1 per cent., so that an available 6 watts of R.F. may become an actual radiated power of only 6 milliwatts! As a transistor may easily generate 50 milliwatts of R.F. it is, in fact, incredible that this possibility of vanishingly small radiation efficiency has not been previously emphasised in R.A.E.N. articles. It is clear that any ingenuity exercised in transmitter design for increased efficiency is almost immaterial when such fantastically high losses are possible. In view of the importance of R.A.E.N. operation, it is desirable that these facts be appreciated, so that efficiency problems can be tackled at the elements so often taken for granted, the loading coil and the antenna radiation resistance.

**Mobile Working**

From the expression given, a number of important results can immediately be deduced. Thus, for R.A.E.N. use in car mobile equipment, a 4ft. whip aerial is often used. This whip will have a radiation resistance of around a twentieth of an ohm. As previous articles have shown, the effective resistance introduced by ground losses can scarcely be reduced below 10 ohms, a figure representative of good practice, and perhaps on the low side for a station operating in a car. Hence without any aerial coil loading losses, the maximum radiation efficiency of 0.5 per cent. is all that could be expected, representing a radiation of 30 milliwatts of R.F. from an average 10-watt transmitter. One loading coil system used for R.A.E.N. tests was wound with fairly thin enamelled wire close spaced on a paxolin tube. The Q of such a coil would be around 150. To load up a 4ft. whip, the effective coil resistance of a coil of Q of 150 comes out at around 50 ohms. Hence the expected radiation efficiency becomes approximately 0.08 per cent. ! Our average 10-watt rig would, therefore, radiate some 5 milliwatts of R.F. With such fractional efficiencies exact calculation is hardly necessary,

Fig. 2.—The base coil loaded aerial equivalent circuit. When tuned to resonance the coil inductance cancels out the aerial capacity as shown on the right.

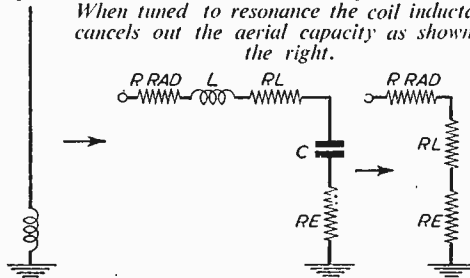

except to indicate the enormous losses to be expected with aerial systems which are taken for granted. In fact, however, such aerial systems are quite often employed. For emergency use it is possible certainly to get a signal across over a few miles. However, under emergency conditions it is possible that the need for consistent reliable operation under Q.R.M.

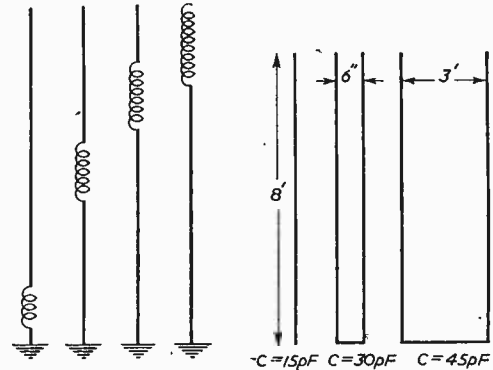

Fig. 3.—(Left) As the loading coil is moved progressively away from the lower end it needs to be larger in order to resonate with the capacity of the free end. Fig. 4.—(Right) For mobile use the aerial capacity may be increased with multiple whips. The wider the whip spacing, the greater the effective capacity of the system.

conditions may make it imperative to ensure an effective radiated signal, particularly as the receiving stations may not be comfortably working at home with large aerials, but also with makeshift aerial systems. Moreover, the enormous room for improvement possible shows that miniature battery valve transmitters drawing very light loads from batteries and operating at very low powers would be ample for emergency communication if the aerial efficiency could be raised.

It is clear that the above example shows the importance of the aerial loading coil losses in the case of the short whip aerial. Thus the coil Q could be raised to, say, 300 by adopting a low loss design. Then the loss resistance would be reduced with a Q of 300 to around 25 ohms, bringing the efficiency up to approximately 0.15 per cent. This means that transmitter power could be halved for the same effective communication radius, a point of considerable importance in an emergency.

The reduction of coil loss to zero would raise the efficiency to 0.5 per cent., but in practice a coil with a Q much greater than 300 is impractical, so that an effective radiation of some 10 milliwatts of power from a 10-watt input P.A. stage is about the limit to be expected from such an arrangement. There are two courses open. One course is to retain a 4ft. whip, but to adopt arrangements for increasing the capacity of the whip. An increased capacity means that a smaller loading coil is needed, so that the loading-coil loss resistance is reduced. However, even with zero coil loss resistance, the earth losses limit the efficiency of the 4ft. whip to around 0.5 per cent. Accordingly, the alternative solution is to use a longer whip. This has a double advantage.

First, for short vertical aerials the radiation resistance increases as the square of the whip length. Thus this immediately quadruples efficiency for a doubled length whip, for constant earth and coil losses. However, the capacity would also be doubled, so that the coil would be half the size and consequently for the same Q value would have halved

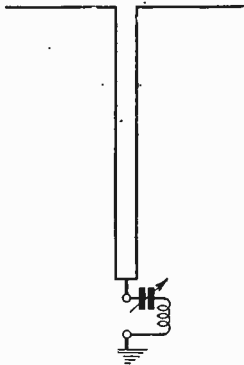

Fig. 5.—At fixed locations a higher frequency aerial system, such as a dipole fed by parallel wire feeders, is often used as a Marconi by strapping the feeders. The parallel wire feeders have a much higher capacity than single wire, so this arrangement is quite efficient for topband use.

ticularly if of a telescoped tube design, the use of an 8ft. whip would raise

efficiency to some 0.7 per cent. This is nearly a tenfold increase over the original illustration of a 4ft. whip loaded by a coil of Q 150. Thus, in terms of operating value, we have increased our signal by nearly two S points compared with the earlier case, or we can use 1 watt of power where before 10 watts were used on the P.A. Alternatively, the range of reliable communication has been usefully increased and the possibility of 100 per cent. mobile communication greatly increased. Extending a telescopic whip to 12ft. from our 8ft. length would, in fact, again double the radiation efficiency, even if coil losses were unaltered, so that a mobile transmitter with a  $\frac{1}{2}$  watt input then becomes a practical proposition.

The importance and attraction of 1.8 Mc/s opera-

tion is that long-range Q.R.M. is not a problem. Thus, 80 metres is nearly a hopeless proposition for R.A.E.N. trials due to the heavy continental Q.R.M. The short range of 1.8 Mc/s signals resulting in generally weak or non-existent continental amateur Q.R.M. enables exercises to be carried out under almost ideal conditions. Unfortunately, Q.R.M. conditions plus erratic radiation effects render higher frequency bands less attractive for many purposes from the R.A.E.N. viewpoint. Accordingly, the physical limitations imposed by the special aerial problems of topband operation must be overcome by careful design and due attention to the basic factors limiting performance.

It should be noted, however, that even with fractional aerial efficiencies reliable communication up to 10 miles or so has been effected on topband mobile operation, even where aerial efficiency could be improved upon. The possibility exists of considerable improvements of the order of 10 to 1 in mobile operation by the measures described. This improvement may pay rich dividends when a sudden emergency arises, as the ability to establish communication outside a limited area may be vital in the conditions of an emergency, which are often very different from the comfortable conditions of an exercise on R.A.E.N. networks.

The demonstration that a 10-watt mobile rig may be "worse off" than a transistor rig operating on an efficient aerial is, of course, substantiated by known facts. Thus, transistor stations have communicated on topband over considerable ranges. This explains why mobile topband stations using considerably more power have maintained communication up to some 20 miles or so even though the actual radiation may be of only a few milliwatts of power. Clearly although a whip aerial of 12ft. height is not the most elegant adornment for a car, it has considerable advantages for mobile use. Multiple whips (see Fig. 4) are also useful for increasing the efficiency of mobile aerials.

## SERVICING RADIO RECEIVERS

(Continued from page 666)

output transformer, using a modulated signal, and adjusting for maximum output on the voltmeter.

Initially, the oscillator tuning should be muted by shorting C2, the receiver adjusted to 550 metres and a 452 kc/s signal applied, via an 0.1  $\mu$ F isolating capacitor, to the signal grid of V1 (top-cap), leaving the top-cap connection *in situ*.

The I.F. trimmers T10, T9, T8 and T7 (Fig. 2) should then be adjusted, in this order, for maximum reading in the output meter. The output from the signal generator must progressively be reduced as the circuits approach correct alignment, and, in order to avoid alignment error as the result of the action of the A.V.C. system, it is essential to use the smallest possible signal, consistent with usable indication in the output meter, throughout the whole of the alignment process.

### R.F. and Oscillator Alignment

Before commencing on this section, remove the short-circuit from the oscillator, and ascertain that the tuning pointer coincides with the base line of the scale when the gang is set at maximum capacitance.

The generator signal must be very loosely coupled

to the frame aerial, preferably by using a small loop aerial as a radiator and energising it directly from the generator. Such a radiator should be situated in the vicinity of 12in. from the receiver and oriented for maximum output.

Alternatively, the output lead of the signal generator may be clipped on the framework of the receiver aerial, but on no account must the generator be connected directly to the receiver.

Tune the generator to 1,410 kc/s, and the receiver to the corresponding calibration mark which lies between 200 and 250 metres on the medium-wave scale. Adjust the medium-wave oscillator trimmer T3 and the aerial trimmer T1 (Fig. 2) for maximum output.

Tune the generator and receiver to 600 kc/s and 500 metres respectively, and adjust the medium-wave padder T5 (Fig. 2) for maximum output.

Repeat the medium-wave alignment process until optimum tracking is achieved over the whole band.

Tune the generator and receiver to 176.5 kc/s and 1,700 metres (long-wave) respectively, and adjust the long-wave padder T6 (Fig. 2) for maximum output. Readjust the generator and receiver to 300 kc/s and 1,000 metres, and tune the long-wave oscillator trimmer T4 and the aerial trimmer T2 (Fig. 2) for maximum output

# SHORT-WAVE SECTION

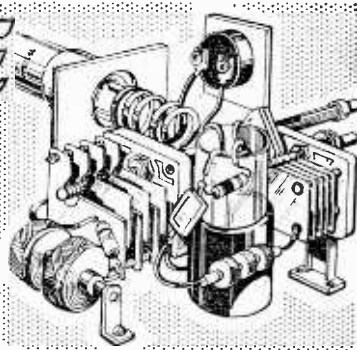

## CHOICE OF INTERMEDIATE FREQUENCY FOR COMMUNICATIONS RECEIVERS

By G. H. BEAMER

ANY type of communications receiver will have a high degree of sensitivity, and high selectivity and freedom from "image" or second-channel interference then becomes increasingly necessary. In many cases the usual intermediate frequency of 465 kc/s, employed in domestic receivers, is by no means best for a special receiver of the kind under consideration. This, however, depends to a large extent on the number and selectivity of any R.F. stages present, as will become apparent.

It is quite usual to employ a much higher intermediate frequency than would be found in a domestic receiver, or to use a double superhet, where two dissimilar intermediate frequencies will be present. The great advantages of this will become clear when it is considered how second-channel interference arises, as shown in Fig. 2. Here it is assumed that a receiver with an I.F. of 465 kc/s is tuned to 30 metres, or 10 Mc/s. The frequency changer oscillator will be operating upon a frequency equal to the signal frequency (10 Mc/s) plus the I.F. (465 kc/s), or 10,465 kc/s. However, due to the manner in which a superhet works a signal 465 kc/s higher in frequency than the oscillator frequency will also be converted to 465 kc/s, and pass through the I.F. stages. Such a signal, in the example, would lie at about 27.4 metres, as indicated. If it is not to be heard, then the R.F. or F.C. signal-frequency tuned circuits must be sufficiently selective to reject signals of about 27.4 metres when tuned to

30 metres. With the simple four or five valve domestic superhet, with no R.F. stage, this will certainly not be so. Even the presence of one R.F. stage may not give sufficient selectivity here. As a result, image signals will appear at the anode of the F.C. stage, and will be heard, no matter how efficient and selective the I.F. stages may be.

The direct result of this will be that all powerful stations appear twice on the tuning dial, once at the correct frequency, and once, at reduced volume, at the image frequency. The lower the wavelength, the closer signal and image tuning points become, so that the trouble grows to an intolerable level. To overcome this, commercial communications receivers employ a high I.F., or ample pre-F.C. selectivity.

### Increase in I.F.

Fig. 2 also illustrates the situation with a receiver having I.F. transformers of 1.6 Mc/s (1,600 kc/s). Here it will be seen that the image signal would arise at about 22.7 metres. To eliminate such an undesired signal, the tuned circuits only require to be sufficiently selective to reject a 22.7 metre signal when tuned to 30 metres. This can be accomplished quite readily because the difference is much greater than when the 465 kc/s I.F. is used, as is clear from Fig. 2.

The 465 kc/s I.F. is not usually found in communications receivers for this reason, except when

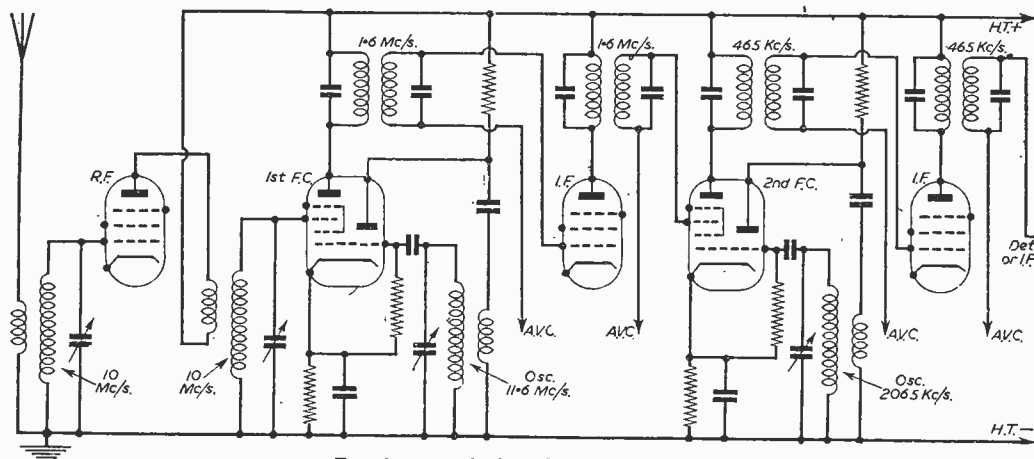

Fig. 1—A typical R.F., F.C., I.F. circuit.

sufficiently selective R.F. tuning circuits are present. On the ordinary broadcast bands image interference grows much less troublesome, because the wavelength difference between signal frequency and image frequency increases. However, with many superhets of simple type, many medium wave whistles and stations may be heard on the long wave band. Here, the signal frequency will be about 150 to 300 kc/s, or 1,000 to 2,000 metres. The oscillator will operate on 615 to 765 kc/s, giving an image frequency range of 1,230 to 1,080 kc/s, or about 250 to 300 metres, which lies in the M.W. band. This accounts for the whistles and interference often found on the L.W. band of such domestic receivers. With an I.F. of 1.6 Mc/s, the image frequency band would be 3,500 to 3,350 kc/s, or about 85 to 90 metres, and any image frequency interference would be very unlikely.

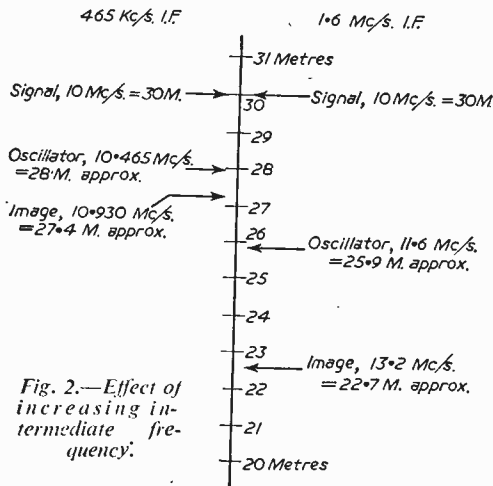

Fig. 2.—Effect of increasing intermediate frequency.

### Double Superhet

Many commercial communications receivers employ two F.C. stages. The first usually converts the signal to a high intermediate frequency, 1.6 Mc/s often being used. This avoids image interference in the manner explained. A second F.C. stage, with fixed tuning, may then convert the signal to a lower frequency, this usually being within the 85 kc/s to 465 kc/s limit. This gives high adjacent channel rejection, or selectivity. As a result, the performance of such a circuit is so good that it is impossible to compare it with the usual domestic four or five valve superhet.

A typical circuit of this kind is shown in Fig. 1. Here it is assumed that a signal on 30 metres, or 10 Mc/s, is being received. Both R.F. and F.C. signal-frequency circuits are tuned to 10 Mc/s by means of the usual gang condenser. This, with the high I.F., virtually eliminates image interference. In some sets the second F.C. stage follows immediately or a stage of I.F. amplification may precede it, as in Fig. 1. No variable tuning is present in the second F.C. stage, which converts to 465 kc/s. One or more I.F. stages of usual type then follow.

These intermediate frequencies lend themselves well to home-construction, as 1.6 Mc/s oscillator coils and I.F. transformers are available. Ordinary 465 kc/s transformers are used in the later stages. The second F.C. oscillator coil does not present any difficulty, as an ordinary tuning coil tunable to around

150 metres is suitable, and available from any coil manufacturers. The circuit is a stable one because only two stages operate upon any one frequency.

It must not be overlooked that oscillator coils and padder values suitable for 465 kc/s are totally unsuitable for 1.6 Mc/s. For example, with 465 kc/s, a L.W. oscillator circuit would tune from 615 to 765 kc/s, but with an I.F. of 1.6 Mc/s, the oscillator tuning range would require to be from 1,750 to 1,900 kc/s. The correct oscillator coils are thus essential.

If the old type 110 kc/s I.F. transformers are to hand, these are very satisfactory for the second I.F. amplifier, with an appropriate oscillator coil in the second F.C. stage. It is of advantage to use a rather low I.F. here, though 465 kc/s is satisfactory.

When the single superhet circuit is used, one R.F. stage is essential; two are often present, with two or more I.F. stages. Compared with the double superhet, difficulties arise in ganging the R.F. stages, and in maintaining stability when several 465 kc/s I.F. stages exist.

### I.F. Interference

Direct pick-up, usually of Morse stations around 650 metres, not infrequently arises in the I.F. stages. Pick-up in these stages may readily be identified on any receiver, as it is not influenced by tuning, and remains the same on all bands. It may be reduced by adequate screening of valves and I.F. transformer leads.

In other cases a slight change of I.F. may be desirable, and the usual 465 kc/s transformers can readily be peaked over a band of 460 to 470 kc/s, or more, as a rule. When this is necessary, experiment will show whether an increase or reduction in frequency is best to remove the interference. The I.F. transformers should then be carefully peaked, it being assured that no trimmer or core needs to come to the limit of its adjustment. The F.C. oscillator coils should then be readjusted, for the new intermediate-frequency, one wave-band being treated at a time. With the double superhet, additional care will be required to avoid direct pick-up, at about 1,600 kc/s, of any powerful station at the bottom of the M.W. band.

### THE PERFECT CHRISTMAS GIFT

What more appropriate Christmas present could you give radio enthusiasts among your friends than a year's subscription for PRACTICAL WIRELESS? All through the coming year your gift will bring them a wealth of advice on their radio problems, and each new issue, as it arrives, will be a fresh reminder of your good wishes.

So easy to arrange, too. Simply send your friends' names and addresses with your own and remittance to cover (an annual subscription for PRACTICAL WIRELESS—12 issues, including postage—costs 13s. 6d.) to Subscription Manager (G.1), George Newnes, Ltd., Tower House, Southampton Street, Strand, London, W.C.2. We will despatch first copies to arrive in good time for Christmas, together with an attractive Christmas Greetings Card, made out in your name, to announce your gift.



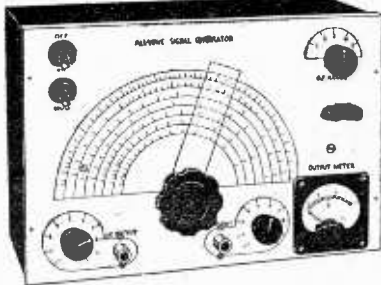

**COMPLETELY BUILT SIGNAL GENERATOR**

Coverage 120 Kc/s-320 Kc/s, 300 Kc/s-900 Kc/s, 900 Kc/s-2.75 Mc/s, 2.75 Mc/s-8.5 Mc/s, 8 Mc/s-28 Mc/s, 16 Mc/s-56 Mc/s, 24 Mc/s-84 Mc/s, Metal case 10 1/2 in. x 6 1/2 in. x 4 1/2 in. Size of scale, 6 1/2 in. x 3 1/2 in. 2 valves and rectifier. A.C. mains 230-250 v. Internal modulation of 400 c.p.s. to a depth of 30 per cent., modulated or unmodulated R.F. output continuously variable 100 milli-volts. C.W. and mod. switch, variable A.F. output and moving coil output meter. Black crackle finished case and white panel. Accuracy plus or minus 2%. £4/19/6 or 34/- deposit and 3 monthly payments 25/- P. & P. 4/- extra.

Heater Transformer, Pri. 230-250 v. 6 v. 1 amp. 6/-.

Three-speed automatic changer, B.S.R. Monarch, current model. Will take 7in., 10in. or 12in. records mixed. Turn-over crystal head, cream finish. VERY LIMITED QUANTITY. A.C. mains 200/250. £7/15/0. P. & P. 3/-.

T.V. CONVERTER for the new commercial stations, complete with 2 valves. Frequency can be set to any channel within the 186-196 Mc/s band. I.F. will work into any existing TV. receiver between 42-68 Mc/s. Input arranged for 80 ohm feeder. EF80 as R.F. amplifier, EOC81 as local oscillator and mixer. The gain of the first stage, R.F. amplifier 10dB. Required power supply of 200 D.C. at 25 mA., 6.3 v. A.C. at 0.8 amp. Input filter ensuring freedom from unwanted signals. Simple adjustments only, no instruments required for trimming. Will work into any T.R.F. or Superhet. Size 4 1/2 x 2 1/2 x 2 1/2 in. P. & P. 2/6. £2/19/6.

Double Wound Mains Transformer, 200/250 v. metal rectifier, and smoothing condenser to suit above, 18/6. Not sold separately. Extension Speaker cabinet in polished walnut, complete with 8in. P.M. P. & P. 3/- 24/6.

8in. P.M. Speakers, removed from chassis, fully guaranteed. All by famous manufacturers. P. & P. 1/6. 12/6.

Volume Controls, Long spindle less switch, 50 K., 500 K., 1 meg., 2/6 each. P. & P. 3d. each.

Used A.C. Mains 200/250 volts, 4-valve plus Metal Rectifier, medium wave superhet in polished walnut cabinet, size 14 x 9 1/2 x 7 1/2 in., complete with valves 6K8, 6K7, 6Q7 and 6F5. 61 PM speaker. Fully guaranteed. P. & P. 7/6. £3/15/-.

Constructor's Parcel: Medium & Long-Wave A.C. Mains 230/250 2-valve plus Metal Rectifier, 22/6. Comprising chassis 10 1/2 x 4 1/2 x 1 1/2 in., 2 waveband scale, tuning condenser, wavechange switch, volume-control, heater trans., metal rectifier, 2 valves and w/holders, smoothing and bias condensers, resistors and small condensers, and medium- and long-wave coil, litz wound. Circuit point-to-point, 1/3. Post and packing, 2/6 extra.

Volume Controls, Long spindle and switch, 1, 1, 1, and 2 meg., 4/- each, 10 K. and 50 K., 3/6 each. 1 & 1 meg., long spindle, double pole switch, miniature, 5/-.

Standard Wave-change Switches, 4-pole 3-way, 1/9; 5-pole 3-way, 1/9. Miniature 3-pole 4-way, 4-pole 3-way, 2/6. 2-pole 11-way twin wafer, 5/-; 1-pole 12-way single wafer, 4/-.



20 watt A.C. or D.C. 200/250 v. fluorescent kit, comprising trough in white-stove enamel, two tubeholders, starter, holder and barretter. P. & P., 1/6. 12/6.

1,000ft. High impedance recording tape on aluminium spool. 12/6 post paid.

Polishing attachment for electric drills. Quarter-inch spindle, chromium-plated, 5in. brush, 3 polishing cloths and one sheep-skin mop, mounted on a 3in. rubber cup. P. & P., 1/6. 12/6. Spare sheep-skin mops, 2/6 each.

**R. & T.V. COMPONENTS (ACTON) LTD.**

23, HIGH STREET, ACTON, LONDON, W.3

**SPECIAL OFFER — VERY LIMITED QUANTITY**  
7 valve push-pull A.C. Mains 200/250 v.

**RADIOGRAM CHASSIS**

3 wave band, coverage short wave 16-50 m., medium wave 187-550 m., long wave 900-2,000 m., 4 controls, volume control on-off, tone control, tuning and wave change with gram position. Valve line up X79, W727, two D177's, two EL41's and E230. Output 7 watts. Size of chassis 16in. x 7in. x 2 1/2 in. Size of scale 12in. x 4in. Overall height including back plate 7 1/2 in. BRAND NEW. Fully guaranteed. P. & P. 7/6. **£9. 19. 6**

**PERMEABILITY TUNED T.V. CONVERTER**  
for new commercial stations



Input 300 ohm balanced line or 80 ohm coax. Coverage 180-200 Mc/s. Vision I.F. 7-10.7 Mc/s. Valve line-up 6AK5 R.F. amplifier, 6AK5 mixer, 6C4 separate oscillator. This is a high gain unit, ideal for fringe areas. Can also be used as F.M. TUNER. Frequency coverage 80-100 Mc/s. I.F. 10.7 Mc/s. Size 9in. wide, 6 1/2 in. deep, 4 1/2 in. high, 9in. scale, width including overlap 14in. Complete with 3 valves, P. & P. 3/- 24/9/6. 10.7 Mc/s I.F.'s to suit above, 4/6 each.



Complete A.C. Mains 3 Valve plus metal rectifier T.R.F. kit. In the above cabinet. £3/15/0, plus 3/6 P. & P.

PLASTIC CAFINET as illustrated, 11 1/2 x 6 1/2 x 5 1/2 in., in walnut or cream. ALSO IN POLISHED WALNUT, complete, with T.R.F. chassis, 2 waveband scale, station names, new waveband, back-plate, drum, pointer, spring, drive spindle, 3 knobs and back, 22/6. P. & P. 3/6.

As above with Superhet Chassis, 23/6. P. & P. 3/6.

As above complete with new 5in. speaker to fit and O.P. trans., 40/- P. & P. 3/6. With Superhet Chassis, P. & P. 3/6. 41/-.

Used Metal Rectifier, 230 v. 50 mA., 3/6; gang with trimmers, 6/6; M. & L. T.R.F. coils, 5/-; 3 Govt. valves, 3/6 and circuit, 4/6; heater trans., 6/-; volume control with switch, 3/6; wave-change switch, 2/-; 32 x 32 mfd., 4/-; bias condenser, 1/-; resistor kit, 2/-; condenser kit, 4/-.

P.M. SPEAKERS, 6in. closed field, 18 6. 8in. closed field, 20 6. 10in. closed field, 25/-, 34in., 16/6. P. & P. on each, 2/-.

Valveholders, Paxolin octal, 4d. Moulded octal, 7d. EF50, 7d. Moulded B7G, 7d. Loctal amphenol, 7d. Loctal pax., 7d. Mazda Amph., 7d. Mazda pax., 4d. B8A, B9A amphenol, 7d. B7G with screening can, 1/6. Duodecal paxolin, 9d.

Twin-gang .0005 Tuning Condens., 5/- With trimmers, 6/6.

32 mfd., 350 wkg. ...	2/-	16 x 16 mfd., 350 wkg. ...	3/3
16 x 24 350 wkg. ...	4/-	60-100 mfd., 280 v. wkg. ...	7/9
4 mfd., 200 wkg. ...	1/3	50 mfd., 180 wkg. ...	1/-
40 mfd., 450 wkg. ...	3/6	65 mfd., 220 wkg. ...	1/6
16 x 6 mfd., 500 wkg. ...	4/6	8 mfd., 150 wkg. ...	1/6
16 x 16 mfd., 500 wkg. ...	5/9	50 mfd., 12 wkg. ...	1/9
16 x 16 mfd., 450 wkg. ...	3/9	50 mfd., 50 wkg. ...	1/9
32 x 32 mfd., 350 wkg. ...	4/-	Miniature wire ends	
25 mfd., 25 wkg. ...	11d.	moulded 100 pf., 500 pf., and .001 ea.	7d.
250 mfd., 12 v. wkg. ...	1/-	280-0-280 80 mA., 4 v. 4 a.	14/6
16 mfd., 500 wkg. wire ends...	3/3	4 v. 2 a.	
8 mfd., 500 v. wkg. wire ends...	2/6	250 v. 350 mA., 6.3 v. 4 a.	19/6
8 mfd., 350 v. wkg. tag ends...	1/6	twice, 2 v. 2 a.	
100 mfd., 350 wkg. ...	4/-	Auto-trans., input 200 250 HT 500 v. 250 mA. 5 v.	
		4 a. twice 2 v. 2 a.	19/6

Potato & Vegetable Peeler, by famous manufacturer, capacity 4 1/2 lbs., complete with water pump. All aluminium construction, white stove-enamel finish. Originally intended for adaption on an electric food-mixer, can easily be converted for hand operation. 39/6. P. & P., 3/-.

Where post and packing charge is not stated, please add 1/6 up to 10/-, 2/- up to £1 and 2/6 up to £2. All enquiries S.A.E. Lists 5d. each.

# CLYNE RADIO LTD.



18, TOTTENHAM COURT RD.  
LONDON, W.1

MUSEUM 5929/0095.  
(50 yards only from Tottenham Court Road Tube)  
All post orders please to:

24-26. HAMPSHIRE RD., LONDON, N.W.1. EUSON 5533/4.5.  
**RECEIVER TYPE 2573.** (The receiver section of TR1196.) Supplied complete with full data for conversion to 3-wave superhet receiver. Unit is complete with 6 valves 2-EP39, 2-EP36, FK32 and EBCC33, also standard I.F.T.s 465 Kc/s. Price 27/8 plus 2/6 P. & P.

**TR1196 TRANSMITTER PORTION.** We can also supply the transmitter portion of the above receiver incorporating valves, EL22, EP39, CV501. Type 400 relay transformer, coils, switches, etc. Limited quantity at 12/8 only, plus 2/6 P. & P.

**No. 38 TRANSMITTER/RECEIVER WALKIE-TALKIE.** Range approx. 3 miles. Coverage 7-4.9 Mc/s. The set only, complete with valves, at 30/-, in very good condition.

**I.F. TRANSFORMERS SPECIAL OFFER.** All iron-cored 465 Kc/s. Phillips size 2-in. x 1-in. diameter (cylindrical), 7/8 pair. By Invecta—Cylindrical 2 1/2 in. x 1 in. diameter, 8/6 pr. Also our own special ultra thin-gauge size 1 1/2 in. x 1 1/2 in. Only 9/9 per pair. By Weacite. Type 301 and 302, 12/6 per pair. Type 551 and 552, 12/6 per pair. M509, 12/6 pr.

**THE "TELETRON" BAND III CONVERTER 11—**This converter which is built around two-valve type EF80 (Z719) is for use with T.R.F. or Superhet Band I television receivers. Complete set of TELETRON coils only, with practical and theoretical wiring diagrams, 15/- post free. Chassis measuring 7 in. x 9 in. x 1 1/2 in., ready drilled to specification. 3/9 plus 9d. packing and post. Alternatively, construction details only with separate individually priced parts list, 6d. post paid. The complete kit as specified, including all the above, valves, etc., down to the last nut and bolt, can be supplied at 48/6 only plus 2/- packing and post. This unit can be supplied ready assembled, wired and tested at 67/6 plus 2/- P. & P.

**POWER SUPPLY.**—If the receiver itself is unable to provide the necessary power, we can supply a complete kit for power pack at 22/6, or power pack ready assembled, wired and tested at 30/-, both plus 1/6 P. & P. A working receiver with this converter attached may be seen at 18, TOTTENHAM COURT ROAD.

**N.B.—**We can supply from stock the full range of Band III aerials by Aerialite, Belling Lee, Teletron, etc. Please state your requirements. **THE R.E.P. ONE-VALVE BATTERY RECEIVER KIT.** Simple one-valve all dry battery receiver for headphones, easily built in one evening. All required components including headphones can be supplied at inclusive cost of 42/- plus 2/- P. & P. Operated by Ever Ready B114 type battery available at 7/6. Assembly details available separately. 1/- post free.

**THE R.C. RAMBLER ALL-DRY PORTABLE KIT**  
Full assembly details with practical and theoretical diagrams can be supplied at 1/6 post free. This is a truly professional 4-valve superhet all dry—for medium and long waves. A cream plastic top panel, with dial engraved in red and green, adds to the very imposing appearance of this model which is housed in an attractive cream and grey leatherette covered attaché-case type cabinet measuring only 9 in. x 7 in. x 5 1/2 in. Weight less batteries 4 1/2 lb., with batteries 6 1/2 lb. This set really has everything! Built-in frame aerial, high quality, extremely sensitive, and very adequate volume from the 9 in. speaker. Valve line-up: 3V4, 1R5, 1R5, 1T4. Also the required components, exactly as specified, including cabinet, can be supplied from stock at the special inclusive price of 27/7- plus 2/6 P. & P. (less batteries). Uses Ever-Ready 90 v. H.T. type B128 at 9/3. Also L.T. 1.5 v. A.D.35 at 1/4.

**RAMBLER MAINS UNIT!**—At last we are able to offer our special mains units kit for users our popular all-dry "Rambler" on A.C. Mains. Complete kit, which when assembled fits snugly into battery compartment, can be supplied at 47/6, plus 1/6 packing and postage. Price includes all required components, and full assembly instructions. N.B.—This unit is completely self-contained in a metal box measuring 7 in. x 2 1/2 in. x 1 1/2 in. and is ideally suitable for ANY all-dry battery portable requiring 90 v. H.T. and 1.5 v. L.T.

**F.M. KITS!** Complete kit available for "DENCO" F.M. Tuner. Price including all components and valves for extra 1/6. Stage 1, 67/6, plus 2/6 P. & P. Constructional details and itemised price list 1/6 post free.

**"JASON" F.M. TUNER KIT.** Our latest based on booklet by Data Publications. Booklet and itemised price list 2/- post free. Complete kit price, which includes attractive front panel and calibrated dial and drive 24/5-, plus 2/6 P. & P. Fringe area model 27/5-, plus 2/6 P. & P. N.B.—All of these tuners are being demonstrated at 18, Tottenham Court Road.

**OUR NEW F.M. KIT IS NOW READY.**—Devised by Gradient Electronics, it employs resonant co-axial line techniques, giving very high "Q"; Booklet with full construction data, and individually priced component list. 1/6 post free.

**THE R.C. 3/4 WATT AMPLIFIER KIT.**—Just released! Compare the advantages! Treble, bass, AND middle tone controls! For crystal or magnetic pick-up! A.C. Mains. 200/250 v. Valve line-up: 6V6GT, 6X6GT, metal 6X4CT. Negative feedback! Built on stove enamelled steel chassis, measuring only 8 in. x 4 in. x 1 1/2 in. Four engraved cream knobs are included in the price of the complete kit with all necessary practical and theoretical diagrams, at 24/5- only, plus 2/6 packing and post, or Instruction Book, fully illustrated, for 1/-, post free! This amplifier can be supplied assembled, tested and ready for use at 25/5-, plus P. & P.

## VALVES!!

We have perhaps the most comprehensive and up-to-date valve stocks in the trade. A stamp will bring list.

● C.O.D. or Cash with order. C.O.D. charge extra—open 9 a.m.—6 pm. Monday to Friday. Sorry, but we close at 1 p.m. on Saturday.

# Taylor

TEST INSTRUMENTS

on Hire Purchase Terms

**TAYLOR Multirange Meter (20,000 o.p.v.).**  
Ideal for Radio and T.V. work. Model 77A

**PRICE £15.0.0. PROMPT DELIVERY.**

### HIRE PURCHASE TERMS

\*3 months £2. 5.0 deposit. 3 monthly payments of £4.15.7  
10 " £1.10.1 " 10 " " " £1.10.2  
15 " £1.10.1 " 15 " " " £1. 1.4  
\* Hire Purchase interest refunded if paid within 3 months.

**TAYLOR Signal Generator.** Model 67A  
Frequency range 100 kc/s-240 mc/s. Accuracy 1%.

**PRICE £22.0.0. PROMPT DELIVERY.**

### HIRE PURCHASE TERMS

\*3 months £3. 6.0 deposit. 3 monthly payments of £7. 0.3  
10 " £2. 4.3 " 10 " " " £2. 4.3  
15 " £2. 4.3 " 15 " " " £1.11.4  
\* Hire Purchase interest refunded if paid within 3 months.

**TAYLOR Multirange Meter (20,000 o.p.v.).**  
Most versatile for Radio, T.V. and Electrical work. Model 88A

**PRICE £22.0.0. PROMPT DELIVERY.**

### HIRE PURCHASE TERMS

\*3 months £3. 6.0 deposit. 3 monthly payments of £7. 0.3  
10 " £2. 4.3 " 10 " " " £2. 4.3  
15 " £2. 4.3 " 15 " " " £1.11.4  
\* Hire Purchase interest refunded if paid within 3 months.

**NEW TAYLOR Valve Tester.** Model 45C  
Measures mutual conductance of over 4,000 up-to-date valves.

**PRICE £27.10.0. PROMPT DELIVERY.**

### HIRE PURCHASE TERMS

\*3 months £4. 2.6 deposit. 3 monthly payments of £8.15.4  
10 " £4. 2.8 " 10 " " " £2.12.7  
15 " £4. 2.8 " 15 " " " £1.17.0  
\* Hire Purchase interest refunded if paid within 3 months.

**TAYLOR Multirange Meter (1,000 o.p.v.).**  
A.C. and D.C. 5 in. scale. Robust, over-load protection. Model 71A

**PRICE £12.10.0. PROMPT DELIVERY.**

### HIRE PURCHASE TERMS

\*3 months £1.17.6 deposit. 3 monthly payments of £3.19.8  
10 " £1. 5.8 " 10 " " " £1. 5.1  
15 " £1. 5.8 " 15 " " " £2. 1.9  
\* Hire Purchase interest refunded if paid within 3 months.

**TAYLOR T.V. Sweep Generator.**  
For T.V. and F.M. alignment. Model 92A

**PRICE £30.0.0. PROMPT DELIVERY.**

### HIRE PURCHASE TERMS

\*3 months £4.10.0 deposit. 3 monthly payments of £9.11.3  
10 " £3. 0.5 " 10 " " " £3. 0.4  
15 " £3. 0.5 " 15 " " " £2. 2.8  
\* Hire Purchase interest refunded if paid within 3 months.

All Taylor instruments are readily available on Hire Purchase Terms. Write for full details and Catalogue. Make sure the instrument you purchase suits your requirements. All Taylor Models are available on a SEVEN DAY APPROVAL SCHEME. You can also part exchange your old Taylor instrument for a new one.

**TAYLOR ELECTRICAL INSTRUMENTS LTD.**

Montrose Avenue, Slough, Bucks.

Tel.: Slough 21381.

Cables: Taylins, Slough.

# IMPROVED T.R.F. TUNING

OBTAINING BETTER SELECTIVITY IN SIMPLE  
STRAIGHT RECEIVERS

By F. G. Rayer

**M**ANY simple T.R.F. receivers are very sensitive, but have exceedingly poor selectivity. At the worst, the local station may hinder proper reception of many distant stations which might otherwise be enjoyed. The tuned circuits used in simple sets of this kind usually resemble those shown in Fig. 1. The coils are often air-cored, and the high sensitivity and absence of reaction further contribute to the extent to which local stations spread over the tuning range.

With such a receiver, reception will be much improved if tuning can be sharpened, even if this results in some reduction in sensitivity. Where a local station gives bad interference, an increase in selectivity is most necessary, and will result in the reception of more stations without trouble from the local, which would otherwise swamp them.

Tuned circuits giving a considerable increase in selectivity, and requiring no major changes to the set, are shown in Fig. 3. Converting to a circuit of this type will have a most noticeable effect. Here, bottom-end coupling is employed in the aerial circuit. With this method, it is essential to prevent any main frequencies reaching the R.F. stage grid. Two fixed condensers are used for this purpose, with a 10 K resistor or H.F. choke. The latter is preferable

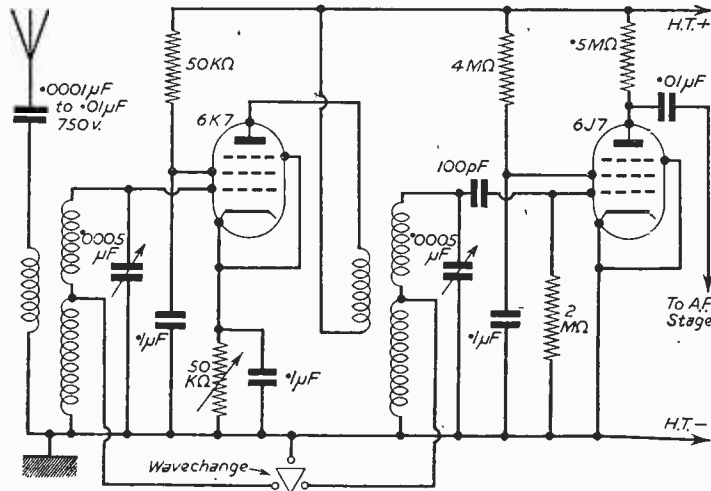

Fig. 1.—Typical tuned circuits of a simple T.R.F. receiver.

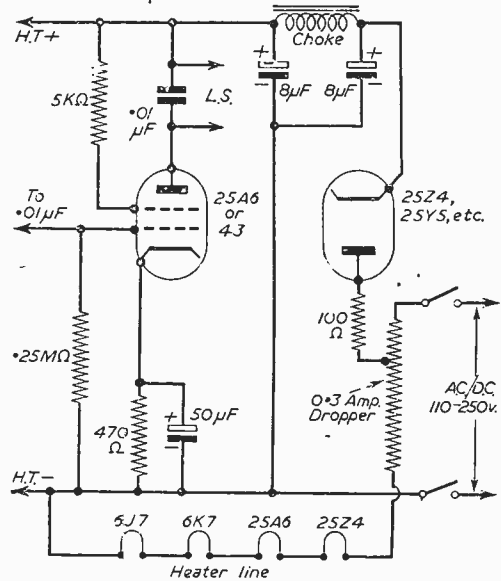

Fig. 2.—Suitable output and power supply circuit.

in A.C./D.C. sets, and as it has a negligible impedance to 50 c.p.s. it will remove modulation hum introduced by the aerial system.

Both aerial and detector coils are dust cored, and the "potted" unit coils produced by Osamor will be found very suitable for these circuit positions, and require no screening. All other components in the set may remain unchanged, with the exception of the wave-change switch, which needs to be a three-pole, two-way component. If no trimmers were originally present, these should certainly be added, as in Fig. 3. Individual trimmers for each coil, making four in all, are not really necessary.

For maximum results, accurate alignment is necessary. This will be even more important than with Fig. 1, due to the greatly increased selectivity. The M.W. band may be treated first, the switch being set for M.W. reception. To align, the coil cores are adjusted at a fairly high wavelength on the band, and the trimmers at a low wavelength. If a station scale is present, adjustments may be directed towards obtaining correct dial readings. If no such scale is present, then adjustments are made for maximum volume only. In each case the cores are carefully adjusted, with an ebonite or similar blade, for maximum volume. A metal blade is not suitable. The trimmers are then adjusted as mentioned, and the procedure repeated, choosing very weak stations. The L.W. band cores

may then be adjusted at a high wavelength, for maximum results.

Fig. 3 also shows a modification to anode-bend detection. This reduces hum, since the detector grid is taken directly through the coils to chassis, and also gives some effective increase in selectivity because of the manner in which this type of detector

rectifier stages. A condenser of about  $.05 \mu\text{F}$ , 750 v. working, wired in parallel with the mains leads, is helpful in keeping modulation hum out of the receiver at this end. In the finished layout, the aerial coils may usually be positioned above the chassis, and the detector coils below. If the R.F. stage just goes into oscillation, at maximum gain, sensitivity

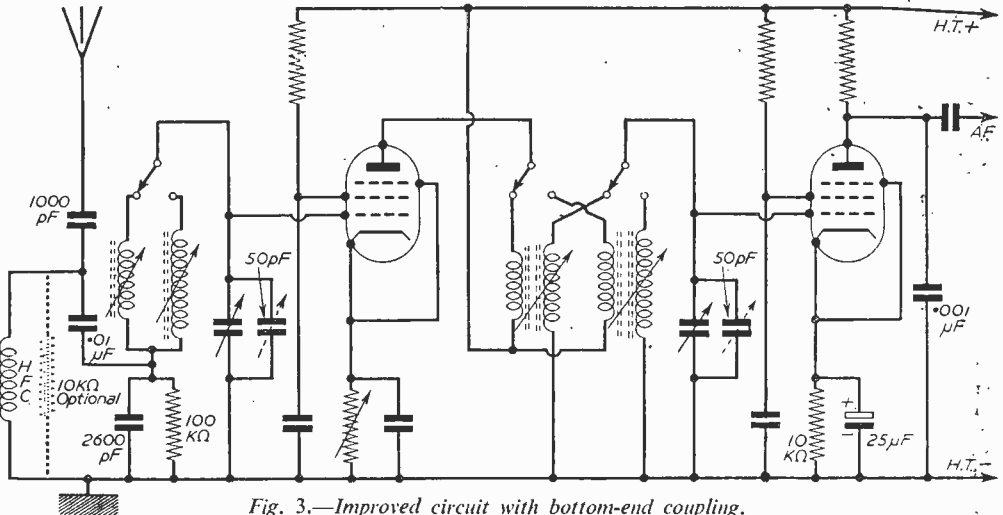

Fig. 3.—Improved circuit with bottom-end coupling.

operates. It should be noted that the usual bias resistor for anode bend detection is far higher than when the valve is employed in other applications, 10 K being suitable for valves such as the 6K7, 6J7, 8D2, etc. A  $.001 \mu\text{F}$  condenser must also be added from anode to chassis.

If the circuit is to be followed in making up a new receiver, then Fig. 2 shows suitable output and

will be increased. Wiring a very small capacity between fixed plates sections of the gang condenser will accomplish this. Two lengths of insulated connecting wire, twisted together for  $\frac{1}{4}$  in. or so, may be used. The capacity should be as small as possible. With this arrangement, and the sharper tuning obtained, the number of stations received without interference may easily be doubled, compared with the circuit in Fig. 1.

## THE PROGRESS OF THE RADIO VALVE

WITHOUT valves, radio and television would never have occupied their present position in the home.

The novel picture on the right issued by Mullard Limited, shows some of their types of valve from 1920, when the feeble signals of the crystal set began to give way to the howl of the reacting detector, to the present day. Last of all comes electronics' infant prodigy, the transistor—born in 1948 and beginning to make its mark—a new and powerful ally to the conventional thermionic valve.

The signpost in the centre of the photograph has one sign pointing back down the road with the direction "2LO—1922"; another that points off the road at the centre stage reads "Television—1936," and the third, which is directed forward to the transistors, reads "V.H.F. Radio—1955."

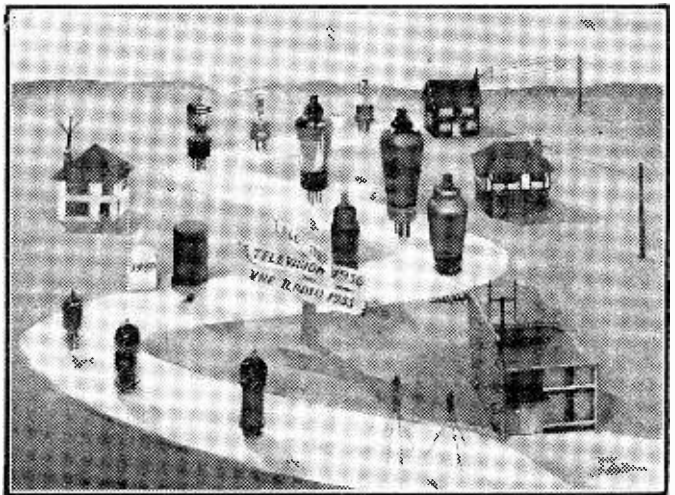

Picture showing progressively the Mullard types of valve used from 1920 to the present time.



heterodyne whistles gave some degree of trouble so that the coupling was changed to an I.F. acceptor type filter. This arrangement gave excellent results. The oscillator and I.F. stages were quite orthodox except that switching was incorporated across both the L.W. oscillator coil and paddler. This was found necessary to facilitate adjustment as otherwise the padders were interdependent.

The detector and output stages were entirely standard, the detector stage using a popular battery

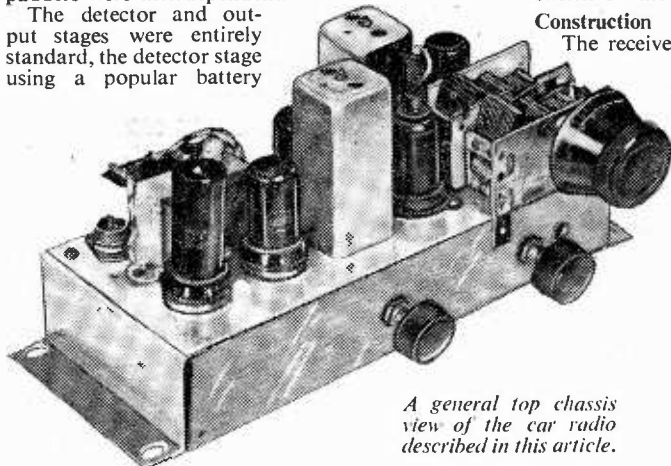

A general top chassis view of the car radio described in this article.

employed and the signal passed to the diode detector, where also the control voltage for the A.V.C. is tapped off. After one stage of L.F. amplification the signal is fed to the pentode output stage and thence to the speaker.

All valves and the rotary generator are parallel connected across the battery and controlled by a switch on the volume control.

**Construction**

The receiver portion is built on a chassis 10½ in. x 4½ in. x 2 in. made of 16 s.w.g. aluminium or steel. The prototype used a steel ex-Government chassis with a "false" aluminium base. The drilling dimensions are shown in Fig. 2, but it must be remembered that these dimensions may have to be modified if components other than those employed in the original receiver are used. This applies especially to the holes for the I.F. transformers, the twin-gang con-



The power unit.

denser, the padders, filter trimmer and the output transformer. It will be seen that the mounting holes for the valve holders are drilled ¼ in. diameter, so that

the receiver and power sections, as finally made used 12 volts or 6 volt valves and the complete installation cost about £6 to £7, as the majority of minor items were found in the "junk box."

Little difficulty was experienced in the electrical design, but upon trial mechanical snags were met, due mainly to the amount of vibration transmitted to the chassis of the receiver. This, however, was overcome by "rubber mounting" the valves and by using anti-vibration washers throughout. Another effect of this vibration was the slow variation of small trimmers, but fortunately it was possible by a little trial and error to utilise a fixed condenser for the main offending item.

The aerial installation and the ignition and cut-out suppression offered no real difficulties and these processes are dealt with fully later.

**Circuit (Fig. 1).**  
The aerial is fed via coaxial cable to the tuning coil which is tuned by T.C.1, the signal then being passed to the mixer-oscillator via the I.F. filter. One stage of I.F. amplification is

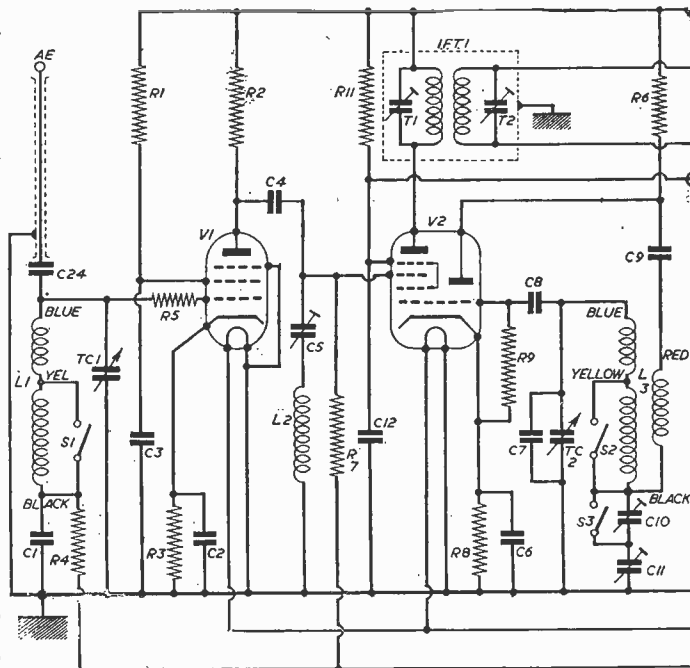

Fig. 1.—Theoretic

grommets can be inserted in them. Thus the Amphenol type holders can be bolted down through these grommets to give an anti-vibration mounting, which, although not absolutely necessary, is an advantage with some valves.

Small strips are bolted to the front of the chassis to take the twin-gang.

Before mounting the components the two I.F. transformers should be carefully marked (I.F.T.1, usually has a flying lead), the coil removed from the can of I.F.T.1 and the grid lead removed

or brought out through the base. The I.F.T.2 is now removed from its can and the diode-filter unit wired up in the coil well clear of the can walls as shown in Fig. 3. If the coil has flying leads, as in the original receiver, it is only necessary to drill a larger hole in the chassis for this

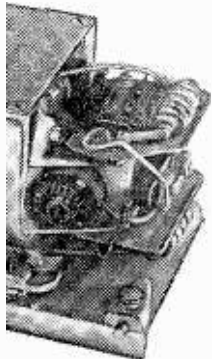

grid wire from the coil is attached and, removing the rest of the rod, drill a larger hole in the base and wire up in a similar manner.

Before commencing to assemble the receiver it is advisable to attach a length of insulated lead to the fixed vanes of the oscillator tuning condenser and pass it through the chassis when mounting this component. Moreover, it will be seen that the wiring diagram has been given for a four-pole three-way

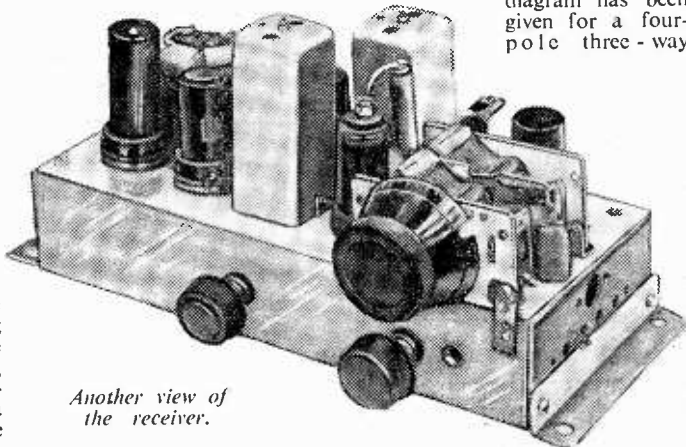

Another view of the receiver.

lead and wire up in the manner shown. If the coil has solid rod wires for connections, however, the rod must be cut just below the point at which the

switch as these are generally much more readily available, although a three-pole two-way switch will suffice. If the switch is wired in accordance with the diagram it will have one long wave and two medium wave positions. It is worth while to wire up the inter-switch connections before mounting and also the earth connections on the valve holders.

Rubber grommets are now inserted in each of the valve holder mounting holes and in the holes A to E. All the components should now be mounted (except the tuning coils, filter components, padders, volume control and wave-change switch), placing soldering tags where necessary. The valve holders can be fitted upwards or downwards through the chassis by passing a 6 B.A. bolt through the grommet and using a fairly large plain washer and anti-vibration washer under each nut.

Anti-vibration washers must be used under all components and care must be taken to ensure correct alignment of valve holders and I.F. transformers.

A considerable amount of the under-chassis wiring can now be carried out, care being taken to keep all the anode and grid leads as short as possible. When as much of this work as is possible is completed the remainder of the components can be mounted and the wiring completed. The aerial coil

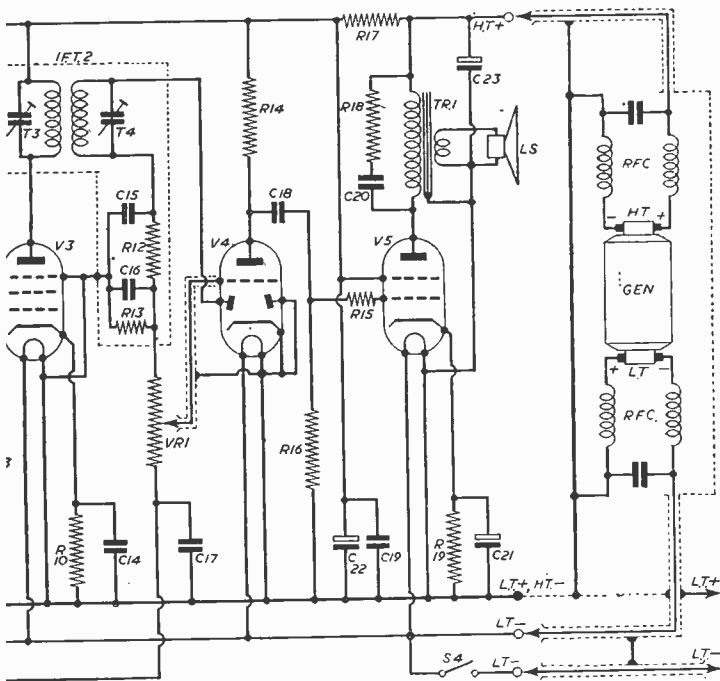

Wiring diagram of the receiver.

is mounted by a Spire nut, but the oscillator coil is mounted by removing the Spire nut, passing a 6 B.A. bolt through the coil, through the padders and bolting both to the chassis.

The padding condensers specified are approximately 250 pF and 500 pF for C10 and C11, but those may have to be adjusted later during alignment.

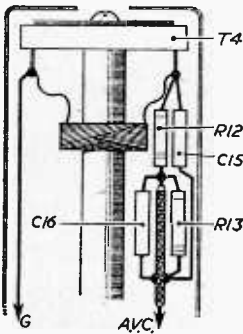

Fig. 3.—The diode filter unit should be well clear of the can walls.

The trimmer C7 is roughly 30 pF, but this again may have to be modified during alignment. Light co-axial television cable is used for the lead to the aerial coil and screened lead for the volume control connections and the grid lead to V2.

Lengths of heavy coaxial cable are now made off, one to extend from the set to the distribution box in the car, one from the set to the aerial and two from

the set to the motor generator. These are fitted with Pye plugs.

It is essential at this stage to check the "polarity" of the rotary converter to ensure that it corresponds with the earthing arrangements of the car electrical system. This is best done by removing the four brushes and checking for continuity between H.T.—, L.T.— and chassis.

The majority of generators have H.T.— to chassis and L.T.— to chassis and these are suitable for a car electrical system using a negative earth. If such a generator has to be used on a car with a positive earth system it is necessary to trace the generator L.T. wiring to find the chassis connection, remove it from the L.T.— side and reconnect it to the corresponding point on the L.T.+ side.

#### Alignment

Alignment can, of course, be carried out in the standard manner using a signal generator, but many constructors are compelled either to forgo the construction of a superhet or employ extreme patience by aligning by trial and error. Fortunately, most homes possess a reliable source of signal at 465 kc/s in a domestic receiver and if this is employed for I.F. alignment the remainder of this stage of the work is relatively simple.

(To be continued)

### LIST OF COMPONENTS

#### RESISTORS

- All  $\frac{1}{2}$  watt unless otherwise stated
- R1, R2, R15—10 K ohms
- R3, R8—220 ohms
- R4, R14—220 K ohms
- R5—1 K ohm
- R6—22 K ohms
- R7, R10, R13, R16—470 K ohms
- R9—50 K ohms
- R11—100 K ohms
- R17—1.8 K ohms (2 watts)
- R18—56 K ohms
- R19—1.5 K ohms (1 watt)
- VR1— $\frac{1}{2}$  megohm potentiometer—with switch

#### CONDENSERS

- C1—.05  $\mu$ F—100 volts
- C2, C6, C14, C17—.1  $\mu$ F—100 volts
- C3, C12, C13, C18—.1  $\mu$ F—350 volts
- C4, C9, C24—1,000 pF—mica
- C8—50 pF—mica
- C15, C16—100 pF—mica
- C19—.02  $\mu$ F—350 volts
- C20—.01  $\mu$ F—350 volts
- C21—50  $\mu$ F—50 volts
- C22, C23—8  $\mu$ F—350 volts
- C5, C7, C10, C11—See text
- TC1, TC2—2 gang—.0005 tuning condenser

#### COILS

- 1 pair of superhet coils—long and medium waves  
Telecoms A/170 and OS/170—Lasky's Radio
- 1 pair of 465 kc/s I.F. transformers
- 1 unit for 465 kc/s I.F. filter
- 1 wave-change switch—2-way, 3-pole

#### SUNDRIES

- 5 octal valve holders
- Chassis to dimensions shown
- Output transformer—60/1 for 2-ohm output
- Tag strips, nuts, bolts, anti-vibration washers, grommets
- 4 Pye type coaxial plugs and sockets
- 4 anti-vibration mounting blocks or rubber pads
- 1 grid lead unit

- 1 rotary converter for 12-volt or 6-volt input with output of 220 volts, 40 mA fully smoothed if possible

Heavy section type coaxial cable, light coaxial cable, screened lead

Loudspeaker—2-ohm coil, 5in.

Slow-motion drive for tuning condenser

#### SUPPRESSION COMPONENTS

- 4 .1  $\mu$ F condenser, 100 volts D.C.
- 1 1 K ohm resistor, 1 watt
- K.L.G.—plug suppressors if necessary

#### VALVES

##### FOR 12-VOLT SYSTEM

- V1, V3—12SK7
- V2—12K8
- V4—12SR7 or 12SQ7
- V5—12A6
- or equivalent 6-volt version if series-parallel connected

##### FOR 6-VOLT SYSTEM

- V1, V3—6SK7
- V2—6K8
- V4—6SR7 or 6SQ7
- V5—6A6

#### PRESELECTOR RECEIVER

The following alternative or additional components will be required:

- C25—2,200 pF
  - C26—270 pF (see text)
  - C27, C28, C29—100 pF
  - C30—220 pF (close tolerance)
  - C31—750 pF (close tolerance)
  - R20—22 K ohms
  - R21—470 K ohms
  - L4, L5—Preset inductances, Type VMA (E.T.A., Ltd.)
  - L6—Preset inductances, Type VLA (E.T.A., Ltd.)
  - L7, L8—Preset inductances, Type VMO (E.T.A., Ltd.)
  - L9—Preset inductances, Type VLO (E.T.A., Ltd.)
- The following items for the original receiver are not needed: TC1, TC2, C1, C7, C8, C9, C10, C11, C24, R4, L1 and L3



**STERN'S AMAZING BARGAIN OFFER !!**

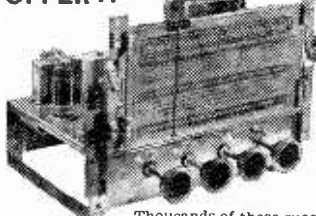

Thousands of these successful and very popular Receiver Chassis have been sold for £15.15.0 each. **WE CAN NOW OFFER THEM FOR £11/19/6** (plus 7/6 carriage and insurance).

**H.P. Terms: Deposit £4.0.0 and 9 Monthly Payments of 19/11.**

These Receiver Chassis have proved to be about the most popular and successful yet offered. Designed to most modern specification, with great attention given to quality of reproduction, giving excellent clarity of speech and music on both Radio and Gram.

They are the ideal replacement chassis for that "Old Radiogram," etc. ALL CHASSIS ARE BRAND NEW AND GUARANTEED FOR 12 MONTHS (B.V.A. VALVES 90 DAYS).

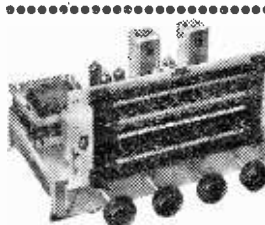

Push-Pull for approx. 7 watts output. They cover 3 wavebands and are for operation on A.C. mains. They make an excellent replacement radiogram chassis.

THEY ARE BRAND NEW AND FULLY GUARANTEED.

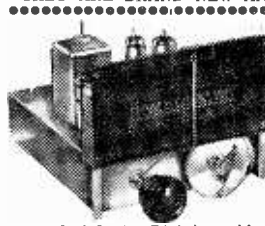

**THE DENCO F.M. FEEDER UNIT INCORPORATING**

A 5 VALVE SUPERHET DESIGN having a frequency coverage of 88 to 100 mc/s. This F.M. Receiver is designed to operate with any type of Amplifier and most Radio Receivers. It incorporates R.F.—F/Changer and two I.F. Stages followed by a Ratio Discriminator, the valve line-up being 6AM6—12AH6—two 5BA6s and 6AQ5. Overall size of assembled chassis 7in. x 5 1/2in. x 4 1/2in. high excluding power supply, or 7in. x 8 1/2in. x 4 1/2in. high with power supply.

The CONSTRUCTOR'S MANUAL, containing Circuit Diagram and Component Layout, etc., is available for 1/6, and WE CAN SUPPLY ALL SPECIFIED COMPONENTS including Valves and Drilled Chassis for **£6/13/6** (plus 2/6 carriage and ins.)

- or for **£7.2.6** with Dial Assembly as illustrated. WE WILL ALSO SUPPLY IT . . .
- (a) Assembled and Ready for use, excluding Dial Assembly **£8/17/6**.
- (b) Assembled and Ready for use, including Dial Assembly (as illustrated), **£9/10/0**.
- (c) Assembled and ready for use, with Dial Assembly and "Magic Eye" Indicator mounted in centre of Dial, **£10/10/0**.
- (d) We can also supply (a), (b) and (c) with and including an H.T. L.T. Power Supply for an additional **£2/17/6**. The Supply Unit is also available as a separate Unit, size 6 1/2in. x 3in. x 5 1/2in. high. Provides 250 volts at 50 mA. and 6.3 volts at 2 amps.

**TWO COMPLETE Hi-Fi AMPLIFIER KITS**



A HIGH QUALITY 8-10 watt AMPLIFIER The ideal Amplifier for General Home Use and for Small Halls etc.

PRICE OF COMPLETE KIT, INCLUDING VALVES AND DRILLED CHASSIS **£7.10.0**. (Plus 2/6 carr. and ins.) WE WILL SUPPLY IT COMPLETELY BUILT

FOR **£9.10.0** (plus 5/- carr. and ins.) H.P. terms **£3.3.6** dep. 8 months at 18/1. Designed for high quality reproduction up to an output level of 10 Watts, having 6V6s in Push-Pull and incorporating negative feed-back. Suitable for use with all types of Pick-ups and most types of microphones and the output transformer provides for use of 3 and 15 ohm speakers.

**BRIEF FEATURES**  
 • Valve line-up 6J5, 6SN7, 5Z4, with 6V6s in push-pull. • First-class reproduction of radio (where a tuning unit is used) and record playing. • Separate Bass Boost and Treble controls provide an excellent range of frequency control. The ASSEMBLY MANUAL is available for 1/- and includes detailed layouts and component Price List.

*Modernise your old Radiogram*

WE HAVE BOUGHT THE ENTIRE STOCK OF THE FAMOUS MODEL B3 PP RADIO OR RADIOGRAM CHASSIS.

A 6-VALVE 3-WAVE-BAND SUPERHET WITH PUSH-PULL OUTPUT.

for **£7/19/6** (plus 7/6 £13.10.0)

- Complete with High Fidelity Crystal "Turn-over" Head which incorporates separate stylus for L.P. and 78 r.p.m. records. • A "MIXER" Unit that will auto-change on 7in., 10in. and 12in. records.
- Brand New in Maker's Cartons, complete with mounting instructions.

**A TEMPORARY EXCEPTIONAL OFFER FOR CASH ONLY**

This B.S.R. Monarch 3 Speed Autochanger is offered carr. and ins.) Normal Price

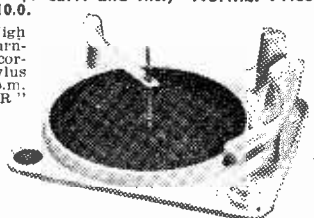

**THE "W.B." PRE-FABRICATED CONSOLE CABINET**

!!HOME CONSTRUCTORS!!  
**BUILD A GENUINE HIGH QUALITY RADIOGRAM for only £33.10.0**

- For this amount we will supply:
- THE MODEL B3PP RADIOGRAM CHASSIS
  - THE B.S.R. "MONARCH" 3-SPEED AUTOCHANGER
  - A MATCHED 10in. P.M. SPEAKER
  - THE "W.B." PRE-FABRICATED CABINET
- Carriage and Insurance on all above equipment is 15/- extra and H.P. TERMS ARE DEPOSIT **£11.3.4** (plus 15/- carr. & ins.) and 12 Monthly payments of **£2.0.11**.

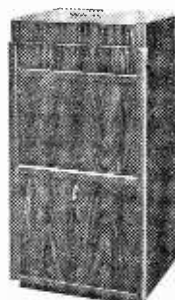

The illustration shows the Cabinet assembled. For Radiogram Constructors, however, we supply it in its PRE-FABRICATED form but we cut the side panels for the Speaker and we CUT THE FRONT PANEL to accept the B3PP Chassis. We also supply a template to enable the Constructor to easily fit the B.S.R. Changer on to the Gram Baseboard.

THIS IS AN OUTSTANDING OFFER. A COMMERCIALY MADE RADIOGRAM OF SIMILAR HIGH QUALITY WOULD COST ABOUT **£65.0.0**. Ideally suitable for "Hi Fi" equipment where a separate Speaker is used, but also equally suitable for a RADIOGRAM or as a TAPE RECORDER CABINET. PRICE **£12.12.0** (plus 7/6 carr. & ins.) H.P. TERMS DEPOSIT **£3.3.0** and 12 monthly payments of 17/8.

**A 12-Watt "HIGH FIDELITY" Push-Pull AMPLIFIER**

Comprising a Main Amplifier Chassis and a Remote Control Pre-Amplifier/Tone Control Unit. The remote control unit measures only 7in. x 4in. x 2in. and contains four controls, being: Bass, Treble, Volume and a Radio Gram. Microphone Switch control. It incorporates its own feed-back circuit on the Bass Channel. Loop negative feed-back is employed on the Main Amplifier which has a valve line up of 6J5-6AV4 with two 6X25s in push-pull and 6J5 and 6SN7 are used in the remote control unit. THE COMPLETE UNIT ASSEMBLED AND READY FOR USE **£17.0.0**. (Carr. and ins. 5/- extra.) H.P. Terms **£4.5.0** Dep. 12 Months at **£1.3.5**. This Amplifier compares well with the Williamson and similar designs at a fraction of their cost. The complete set of assembly instructions is available for 2/-.  
 FOR **£14.0.0**. (Carr. and ins. 3/- extra.)



THE COMPLETE KIT IS AVAILABLE FOR **£14.0.0**. (Carr. and ins. 3/- extra.)

**STERN RADIO LTD. 109 & 115 FLEET ST., E.C.4.**

Telephone **FL Eet 5812/3/4**

# HENRY'S

(RADIO LTD.)

CRYSTAL MICROPHONE INSERTS



POST FREE POST FREE  
Ideal for tape recording and amplifiers. No matching transformer required.

**BAND III CONVERTER UNIT**

Complete Kit of Parts. Including 2-EF80 and Chassis and Wiring Diagram. Voltage required 200 v. at 30 mA 6.3 v. 6 amps. 48/6, plus 2/- P.P. Or assembled and tested, 67/6, plus 2/- P.P. Power Supply Components, 22/-  
The Unit Complete with Power Supply. Tested and ready to plug in. 67/6.

**"RF 26" F.M. CONVERTER UNIT 88/100 Mc/s**

This well-known RF26 Unit is now adaptable for F.M. reception using 2 IF stages and separate local Oscillator and tuned by a Muirhead graduated, Vernier drive. Can be converted at low cost of 62/6. Send 1/6 for 8-page Descriptive booklet containing full wiring instructions, circuits and layout diagrams.

**B.S.R. 3-SPEED AUTO-CHANGERS**

These are brand new in original cartons. Plays mixed records. Cream finish. List price £16.10.0. Our Price 27/19/6, carr. 3/-.

**EF50 (VR91A)**

The selected EF50, Red Sylvania, original boxes, 10/- each, 90/- for ten.

**U.S.A. INDICATOR UNIT Type BC929A**

These Units are in absolutely new condition. In black crackle cabinet 14in. x 9in. x 9in. Complete with 3 BP1 CRT Tube, shield and Holder, 2-6SN7GT : 2 6H6GT : 1 6X5GT : 1 2X2 : 1 6G6, V/controls, condensers, etc. Ideal for scope. 65/-, Carr. Pd.

**CATHODE RAY TUBES (Brand New)**

VCR97 (slight cut-off) 15/-  
VCR97 guaranteed full TV Picture 40/-  
VCR517C, guaranteed full TV Picture 35/-  
VCR139A, guaranteed TV Picture 35/-  
3BP1, guaranteed full TV Picture ... 30/-  
Carr. & packing on all tubes, 2/-.

**BC966A I.F.F.**

Containing 13 valves 3-7193, 7-6SH7, 3-6H6 metal. 18 v. dynamotor and fan output 450 v. 60 mA with three-speed geared motor plus 4 relays, condensers and resistors, in good condition. 35/-, carr. 5/-.

**VIBRATOR PACKS, ETC.**

Input 12 v., output 244 v. 44 mA ... 25/-  
Input 6 v., output 180 v. at 40 mA ... 21/-  
Vibrator Transformers 6 v. 180 v. 40 mA 7/6  
Vibrator Transformers 6 v. 250 v. 80 mA ... 8/6  
Vibrator Transformers 12 v. 250 v. 90 mA 8/6  
Vibrators 12 or 24 v. 4 pin 5/-  
Vibrators 6 v. 7 pin synchronous 12/6  
Vibrators 12 v. 7 pin synchronous 12/6  
Vibrators 2 v. 7 pin synchronous 7/6

**PYE 45 Mc/s STRIP TYPE 3583 UNITS**

Size 15in. x 8in. x 2in. Complete with 45 Mc/s Pye Strip, 12 valves, 19 EF50, EB34 and EA50, volume controls and hosts of Resistors and Condensers. Sound and vision can be incorporated on this chassis with minimum space. New condition. Modification data supplied. Price 69/6, Carriage paid.

**VALVES - VALVES - VALVES**  
WE HAVE OVER 50,000 AMERICAN AND ENGLISH VALVES IN STOCK AT VERY LOW PRICES. SEND 3d. FOR 28-PAGE ILLUSTRATED CATALOGUE.

**62A INDICATOR UNIT**

Containing VCR97 with Mu-Metal Screen 21 valves — 12-EF50, 4-SP61, 3-EA50, 2-EF34, Plus Pots., Switches, H.V. Cond., Resistors, Muhead S/M. Dial, Xtal, Double Deck Chassis. BRAND NEW. ORIGINAL CASES. 67/6, carr. 7/6.

**INDICATOR UNIT TYPE 182A**

Unit contains VCR517 Cathode Ray 6in. tube, complete with Mu-Metal screen, 3 EF50, 4 SP61, and 1 5U4G valves, 9 wire-wound volume controls and quantity of resistors and condensers. Suitable either for basis of television (full picture guaranteed) or Oscilloscope. Offered BRAND NEW (less relay) at 67/6. Plus 7/6 carr. "Radio - Constructor" scope circuit included.

5, HARROW ROAD, PADDINGTON, LONDON, W.2

TEL : PADDINGTON 1008/9, 0401.

# WEYRAD

## COMPONENTS FOR RADIO, TELEVISION AND F.M. RECEIVERS, AM/FM COIL PACK—TYPE B.60

A complete unit covering Long-wave, Medium-wave and the FM Band. Consistent performance at V.H.F. is assured as all wiring to the valve holders and their associated components is completed and the pack is ready for installation into the receiver chassis. The B.60 has been designed for use with the 6BE6 frequency changer which provides excellent performance on all Bands. The 4-position wave-change switch has an extra wafer for the automatic selection of the appropriate detector stage output.

A special 2-gang, 2-section Tuning Condenser is employed and is supplied as an additional item.

### TUNING SCALE—TYPE TS.60

Printed upon glass in 3 colours. Suitable for standard drive units with horizontal pointer travel of seven inches.

### AM/FM I.F. TRANSFORMERS AND RATIO DETECTOR—P21/1 AND P21/2

Designed for AM operation at 470 kc/s and FM operation at 10.7 Mc/s. The coils are wound on moulded formers and the cores are accessible from opposite sides of the screening can. It is recommended that two I.F. stages should be employed (valves 6BA6) while the detector stage uses a triple-diode-triode such as the EA8C80. The ratio detector has been selected after careful tests showing very definite advantages over other arrangements. It is comparatively simple to construct and can be aligned without the aid of an FM signal generator.

### 10.7 Mc/s I.F. TRANSFORMERS AND RATIO DETECTOR—P20/1 AND P20/2

For FM Receivers—wound on moulded formers, core adjustment at top and bottom of transformer. Ratio detector simplifies receiver construction and alignment without sacrificing performance.

SEND STAMP FOR DETAILS AND PRICES.

## WEYMOUTH RADIO MANUFACTURING CO., LTD.

CRESCENT STREET, WEYMOUTH, DORSET

# UNDERSTANDING F.M. DISCRIMINATORS

AN ANALYSIS OF THE CHIEF FUNCTIONS OF F.M. DISCRIMINATOR CIRCUITS

By G. JOWETT

**I**N order to achieve a practical understanding of F.M. discriminator circuits, it is first necessary to be knowledgeable with respect to certain fundamental properties of tuned circuits. To gain knowledge along these lines let us examine the chief characteristics of the coupling transformer used in the ratio detector circuit. Such a transformer is shown at Fig. 1.

Although it is the purpose of this transformer to convey an I.F. signal to the detector, as it is in an A.M. receiver, it also takes advantage of two inherent properties which are fundamental to the operation of the ratio detector. It may be seen from Fig. 1 that the primary winding L1 is quite conventional, that the secondary winding L3 is centre-tapped, and that an extra winding L2 (generally known as a tertiary winding) is coupled to L1.

Now let us suppose that L1 is tuned spot on to the frequency of a signal applied across it—this signal would, of course, be developed in the anode circuit of the final I.F. valve. Let us also suppose that L3 is tuned spot on to the same frequency. Under these conditions the signal voltage appearing across L1 will be induced across L3.

### A Question of Phase

Apart from this well-known occurrence, however, the phase between the voltages across the two windings will differ by a quarter-cycle, or 90 degrees. This, then, is the first important property of tuned and coupled circuits, and one on which the operation of almost all discriminators is pivoted. Remember that this 90 degree phase difference only exists when both of the coupled circuits are tuned to the frequency of the applied signal.

The voltage induced across the tertiary winding L2 from the primary L1 does not follow this law. This is because L2 is not tuned, and the second important property of coupled circuits of this kind is that the voltage induced across an untuned secondary winding remains in phase with the voltage across the tuned primary. Clearly, then, the voltage across L1 is in phase with the voltage across L2, but 90 degrees out of phase with the voltage across L3.

### A Phase Change

If the frequency of the signal applied to the tuned primary winding L1 deviates from the frequency to which the primary is resonant the 90 degree phase difference between the voltages across the primary and secondary no longer holds good. The phase difference will change from 90 degrees and fall to the "in-phase" condition as the applied signal swings outside the response of the tuned primary winding. The phase changes gradually as the frequency of the applied signal deviates from its nominal value, but it does not change linearly with frequency.

Since L2 is untuned, the relative phase change between the voltages across L1 and L3, therefore, is the same as that between the voltages across L2 and L3. The winding L2 simply permits extraction of the character of the signal in L1, whilst removing the D.C. content.

Before proceeding it will be as well to consider the character of the signal actually appearing across the secondary winding L3. As this winding has a centre-tap, the voltage across section AB rises positively while the voltage across section CB rises negatively. This is analogous to a balanced push-pull arrangement when the centre-tap is taken to a reference point. It is clear to realise, therefore, that when point A goes positive point C goes negative. In other words, the voltages at points A and C are exactly 180 degrees out of phase.

### A Reference Point

Fig. 1 shows the centre-tap of L3 connected to one side of L2. This gives L3 a reference with respect to the voltage across L1, so that when the frequency of the applied signal equals the tuned frequency of L1 and L3, L3 is given a 90 degree phase reference with respect to L1. Since the reference point is the centre-tap on L3 and the phase difference is exactly 90 degrees, the voltage across L2 ( $eL_2$ ) is added equally to the voltages across sections AB of L3 ( $eL_3'/2$ ) and CB of L3 ( $eL_3''/2$ ). This means that the voltages between points DA ( $eDA$ ) and DC ( $eDC$ ) are equal. This will only hold true, however, as long as a phase difference of 90 degrees exists between the voltages across L1 and L3 (see Fig. 2).

### The Magnitude of the Voltages

Now, if two voltages which are in phase are added together the combined voltage equals the arithmetical sum of the two. If the two voltages are anti-phase (i.e., 180 degrees) one subtracts from the other, and if their magnitudes are equal one cancels the other out so the result is zero. If the

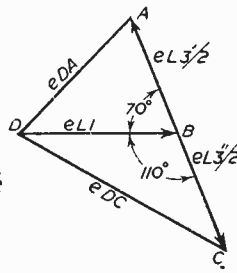
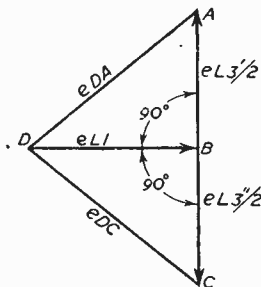
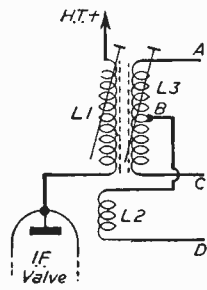

Fig. 1 (left).—The ratio detector transformer. Fig. 2 (centre).—A vector diagram showing the condition of balance. Fig. 3 (right).—A vector diagram showing the condition of unbalance.

phase difference is 90 degrees the combined magnitude of the two voltages is equal to  $\sqrt{E_1^2 + E_2^2}$ . The combined output due to two voltages of intermediate phase angles therefore ranges from between the in-phase condition, past the 90 degree condition, to the anti-phase condition depending on the magnitude of the phase angle and the relative voltages.

There is really no point in us investigating mathematically the function of voltage with respect to phase. For the purpose of this discussion it is sufficient to realise that the combined magnitude due to two A.C. voltages depends on their phase difference.

A better mental picture of the effect can often be obtained by using vector diagrams. For example, the vector diagram at Fig. 2 refers to the points and voltages distributed across the transformer at Fig. 1 when the frequency of the applied signal equals the tuned frequency of L1 and L3. From this we can clearly see that eL2 has a phase difference with respect to either eL3/2, and that eDA equals eDC.

We should not have any difficulty now in realising that if anything happens to disturb the 90 deg. phase difference between the voltages in L2 (which, remember, is a replica of the voltage in L1) and L3, the state of BALANCE will be upset and the voltages at A and C relative to D will no longer be equal. Say the phase between them change by 20 deg., eL3'/2 will swing 20 deg. towards eL1 (which is 90-20=70 deg.) and eL3''/2 will swing 20 deg. away from eL1 (which is 90+20=110 deg.); eDC will thus become greater and eDA smaller. This UNBALANCED state is illustrated in the vector diagram at Fig. 3.

**The Ratio Detector**

We have now reached the point where it is necessary to apply the transformer at Fig. 1 to a ratio detector

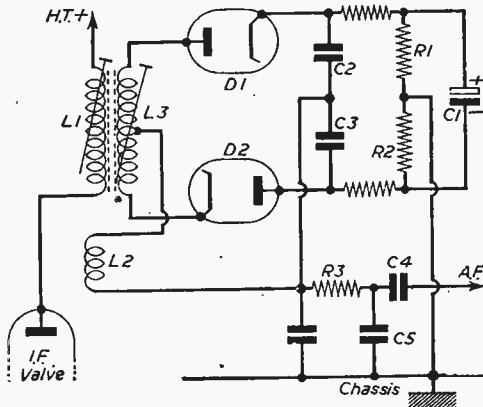

Fig. 4.—The ratio detector.

circuit. Such a circuit is shown at Fig. 4. In practice it may be found to vary slightly in make-up, though there is little difference between the operation of the variants. The circuit illustrated is of the balanced mode; an unbalanced arrangement is very similar in function, but either C2 or C3 may be omitted and one load resistor may be used instead of the two (R1 and R2) shown in Fig. 4.

It will be observed that the two diodes D1 and D2 are connected back-to-back. As a result of this,

when the nominal frequency of the applied signal equals the tuned frequency of the transformer (the balanced condition), each diode will receive an equal but opposite voltage. The diodes will, therefore, conduct equally, and a steady D.C. potential will develop across R1 R2, which will charge the stabilising capacitor C1.

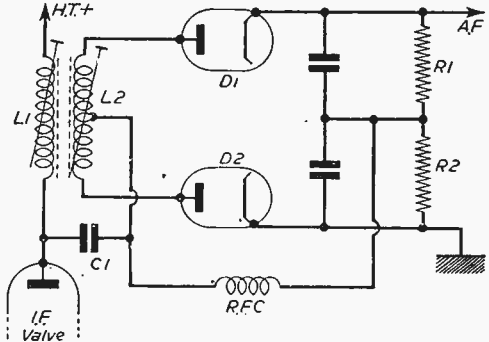

Fig. 5.—The Foster-Seeley discriminator.

Now, when the frequency of the applied signal deviates about its nominal frequency, as is what happens when the signal is frequency modulated, the condition of balance will be upset and one diode will receive more voltage than the other. One diode will, therefore, conduct more heavily than the other, but, since the diodes are connected back-to-back, the diode which is in receipt of the smaller voltage is not able to pass the extra current taken by the diode which is in receipt of the larger voltage. This extra current has to flow out of the diode circuit, and it does this by way of L2 and either C2 or C3, depending on which diode is conducting the heavier.

At this point we must remember that the frequency of the signal is deviated at a rate equal to the frequency of the modulation. Since this is at A.F., a voltage rising and falling in rhythm with the modulation is developed between the junction of C2 C3 and the junction of R1 R2. The junction of R1 R2 is returned to chassis, and the A.F. signal is taken through R3 and C4 to the A.F. stages of the receiver.

It is as well to remember that the magnitude of the A.F. output voltage is governed by the frequency of DEVIATION and NOT by the frequency of the modulation. The term "deviation" in F.M. practice is synonymous to the term "depth of modulation" as applied to A.M. practice.

Capacitor C5 and resistor R3 serves as a deemphasis network, whose function is to compensate for the treble boost applied to the modulation at the transmitter.

**The Foster-Seeley Discriminator**

Now that we understand the operation of the ratio detector, assimilation of the older style Foster-Seeley discriminator should present no problem at all. A typical circuit of this discriminator is shown at Fig. 5. Here will be seen that one of the diodes is connected in reverse to that in the ratio detector, and that a phase reference is given to L2 by means of the small coupling capacitor C1.

When the diode circuit is balanced, that is when the

(Continued on page 693.)

## BAND 3 T/V CONVERTER—186 Mc/s - 196 Mc/s £2-5-0 post free.

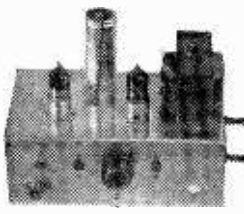

This Unit, comprising drilled chassis, 7in. x 4in. x 2in., valves, wound coils, etc., is a slightly modified version of the circuit shown in *Wireless World*, May, 1954. It has proved itself highly successful—over 1,000 sets were sold in the first month to buyers all over England. We invite you to visit us and see it in operation for yourselves. Suitable for all types of T/V sets, T.R.F. or Superhet and all channels, 42 Mc/s to 68 Mc/s. Blueprint and circuit

details will be sent on application by return of post, 1/6 post free. Supply voltages required 200-250 v., 20 mA H.T. 6.3 v. 1 a. L.T.

Power Pack components to fit chassis, as illustrated, 30/- extra. Complete set wired, tested and aligned ready for use 15/- extra. Band 1, Band 3 Ac. switching can now be added, switch kit 7/6. Full range of Band 3 aerials in stock. Adaptors from 7/6 per set, dipoles from 6/6 each.

### Volume Controls

Midget Edlwan type. Long spindles. Guaranteed 1 year. All valves 10,000 ohms for 2 Meg-ohms.  
No Sw. S.P.Sw. D.P.Sw. 3/- 4/- 4/6  
COAX PLUGS ... 1/2  
SOCKETS ... 1/-  
COUPLER ... 1/3  
OUTLET BOXES ... 4/6

### 80 ohm COAX

STANDARD (in. diam.) Polythene insulated. GRADE "A" ONLY.  
**8d. yd.**  
SPECIAL — Semi-air spaced polythene. 80 ohm Coax (in. diam.) Stranded core. Losses cut 50%. **9d. yd.**

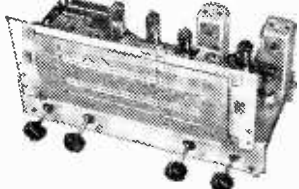

**ALL WAVE RADIOGRAM CHASSIS**  
**THREE WAVEBANDS FIVE VALVES**  
S.W. 16 m.—50 m. LATEST MIDGET  
M.W. 200 m.—550 m. B.V.A.  
L.W. 800 m.—2,000 m. SERIES.

Brand New and Guaranteed. A.C. 200/250 v. Four position. Wavechange switch. Short-Medium-Long-Gran. Pick-up connections. High Q iron-dusted coils. Latest circuit technique, delayed A.V.C. and Negative feedback. Output approx. 4 watts. Chassis size 13 1/2 x 2 1/2 in. Glass Dial—10in. x 4 1/2 in. horizontal or vertical type available, lit by 2 Pilot Lamps. Four Knobs supplied. Walnut or Ivory to choice, aligned and calibrated ready for use. Chassis isolated from mains. **PRICE £9. 15. 0**  
Carriage and Insurance, 4/6. **PRICE £9. 15. 0**  
8in. or 10in. speakers to match available.

**BALANCED TWIN FEEDER** per yd. 6d. } 60  
**TWIN SCREENED FEEDER** per yd. 1/- } ohms  
**50 OHM COAX CABLE** 8d. per yd. (in. dia.)  
TRIMMERS, Ceramic, 4 pf.—70 pf., 9d. 100 pf., 150 pf., 1/3; 250 pf., 1/6; 600 pf., 1/9. PHILIPS Beelive Type—2 to 8 pf. or 3 to 30 pf., 1/8 each.  
RESISTORS—Pref. values 10 ohms 10 megohms.

**CARBON WIRE WOUND**  
20% Type, 1/2 w., 3d.; 1 w., 5d.; 1 w., 8d.; 2 w., 9d.  
10% Type, 1/2 w., 8d.; 1 w., 1/-; 1% Hi-Stab. 1 w., 2/-.

**WIRE-WOUND POTS**  
Pre-Set Min. T.V. Type. Knurled Slotted Knob. All valves 25 ohms to 30 K., 3/- ea. 50 K., 4/-; Ditto Carbon Track 50 K. to 2 Meg., 3/-.

**CONDENSERS**—Mica, S. Mica, Ceramics. All pref. values. 2 pf. to 680 pf., 6d. ea. Tubulars. 450 v., Hunts and T.C.C. .0005, .001, .005, .01, .02, and 1.350 v., .9d., .05, 1.500 v. Hunts Mold Seal, 1/1, .25 Hunts, 1/8, .5 Hunts, 1/9, 1.1500 v. T.C.C. (Simplex), 3/8, .001, 6 k.v., T.C.C., 5/6, .001 12.5 k.v. T.C.C., 6/6.

**SILVER MICA CONDENSERS**—10%  
5 pf. to 500 pf., 1/-; 600 pf. to 3,000 pf., 1/3, 1% 1.5 pf. to 500 pf., 1/9, 315 pf. to 5,000 pf., 2/-.

### BARGAIN VALUE IN RECORD CHANGERS

Recommended for above chassis

**B.S.R. MONARCH**—Latest Model 3 sp. Auto-changer Mixer Unit. Famous *Winkidisc*, 7, 10 and 12in. Record selector. Modern Cream Styling Dual Xtal Cartridge Stylus for Hi-Fi reproduction. As used by leading manufacturers. Bargain Price.

**9 1/2 Gns. post free.**

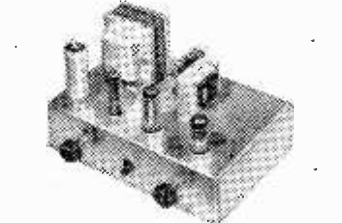

### 3 VALVE AMPLIFIER

With variable Tone and Volume controls. 3 Midget B.V.A. valves. 4 watts output. Neg. feedback. Chassis isolated from mains. A.C. 200/250 v. A quality amplifier at an economical price. **PRICE £3.19.8.** Carr. 2/6. Wired and tested, 7/6 extra. Blueprint, circuit and instr., 1/6 (free with kit).



## RADIO COMPONENT SPECIALISTS (THO. 2188)

70 BRIGSTOCK ROAD, THORNTON HEATH, SURREY

Buses 130A, 133, 159, 166 & 190

Send 3d. stamp for Bargain Lists. Hours: 9 a.m.—6 p.m. 1 p.m. Wed. OPEN ALL DAY SAT.

N.E.—Terms C.W.O. or C.O.D. Post/Packing up to 1 lb. 6d., 1 lb. 1/-, 3 lb. 1/6, 5 lb. 2/-, 10 lb. 3/6.

### ELECTROLYTICS ALL TYPES NEW STOCK

Tubular Wire Ends	84+16/450 v. Hunts 5/-
25/25 v., 50/12 v.	1/9 16+16/275 v. T.C.C. 4/6
30/50 v., 4/500 v.	2/- 16+16/450 v. B.E.C. 5/6
100/25 v.	2/- 16+16/450 v. T.C.C. 6/-
8 500 v., Dub.	2/6 16+24/350 v. B.E.C. 5/-
8+8 500 v., Dub.	4/6 25/350 v. B.E.C. 4/-
8+16 450 v. Hunts	5/- 22+22/450 v. B.E.C. 6/6
16/450 v. B.E.C.	3/6 60/350 v. B.E.C. 6/6
16+16/450 v. T.C.C.	5/6 60+100/350 v. 11/6
32/350 v. B.E.C.	4/- 60+250/275 v. 12/6
32/500 v., Dub.	5/- 100+250/275 v. B.E.C. 12/6
92+32/500 v., Dub.	7/6 1000+1000/6 v. B.E.C.
Can Types, Clips, 3d. ea.	6/8 500 mfd. 12 v. 3/-
9+8/450 v. T.C.C.	4/6

### MAINS TRANSFORMERS

—Made in our own Workshops to Top Grade spec. Fully interleaved and impregnated. **RADIO AND AMPLIFIER TYPE**—250 v., 60 ma. P.W. sec. 5 v. or 6.3 v. 1 a. rect. 4.0 v. 2.5 a. set Htrs., 21/-, etc. **G.R.T. HTR., ISOLATION TYPE**—Low leakage with or without 25% sec. boost voltage. Ratio 1:1 or 1.25, 2 v., 10/6; 4 v., 10/6; 6.3 v., 10/6; 13.3 v., 10/6. Ditto with mains primaries 200/250 v., 12/6. Specials to order. **SPECIAL TYPES**—To designers spec.: Simplex, 35/-; Viewmaster, 35/-; Lynx, 30/-; T/V Tape Deck, 22/6; Soundmaster, 35/-; Mullard Amp., 35/-; Osram 912, 35/-; **BEATER TRANSF.**—Prim. 200/250 v. 8.3 v. 14 a. or 4 v. 2 a., or 12 v. 15 a., 7/6; 6.3 v. 3 a. or 5 v. 3 a. or 4 v. 4 a., 10/6.

**L.F. CHOKES**—10 H. 65 ma., 5/-; 15 H. 100 ma., 10/6; 10 H., 120 ma., 10/6; 20 H. 150 ma., 15/6. **SIMPLEX**, 10/6; **SOUNDMASTER**, 10/6; **P.W. Q.H. gram.**, 13/6. **OUTPUT TRANSF.**—Soundmaster 6/6; P.W. Quality Ngram., 35/-; Osram 912 sectionalised windings, £3.10.0. Htrs. surplus types, standard pentode, 4/6; ditto tapped prim., 4/8; small pentode, 3/9; Midget battery pentode (184, 3V4, etc.), 4/6.  
**SOLO SOLDERING IRONS** (200-220v. or 230-250v.) 25 watt, instrument type, 19/6; 65 watt, Penclit Bit Type, 25/-; 65 watt, Oval Bit Type, 23/- (comprehensive stock of spares available).  
**CRYSTAL DIODE**—Very sensitive. G.E.C., 2/-



**F.M. TUNER-UNIT** (87 mc/s—105 mc/s), by Jason. —As tested and approved by Radio Constructor. Complete Kit of parts to build this modern highly successful unit, drilled chassis and J.B. dial, coils and cans. 4 B.V.A. miniature valves and all components, etc., for only, £6.10.0, post free. **SUPERIOR TYPE GLASS DIAL**—Calibrated in Mc/s and edge lit by 2 pilot lamps, 12/6 extra. Illustrated handbook with full details, 2/-, post free.

NEW BOXED	VALVES	GUARANTEED	ALL
1R5	7/8 6Q7	8/6 EF41	10/6 MUL4 12/6
1R5	7/8 6SN7	9/- EF50	PCP84 8/6
1T3	7/6 6V6	7/6 Mullard 10/-	PCP90 12/6
1S4	7/6 6X4	8/6 EF50	PCP82 12/6
3S4	8/- 6X5	8/- Equip.	5/6 PL81 12/6
3V4	8/- EA50	2/- EF80	10/6 PL82 12/6
3D6	3/6 EBC41	10/6 EF86	13/6 PL83 12/6
5Z4	8/6 B191	7/6 EF91	8/6 PY81 11/-
6AM6	8/6	EBC33	8/6 EL41 11/6 PY82 12/6
6AT6	8/6	EBC33	8/6 EL41 11/6 PY82 12/6
6CH6	10/6	EL41	12/6 EL84 12/6 SP41 5/6
6HM6	3/6	EL41	12/6 EL84 12/6 SP41 5/6
6K7	6/6	EL80	12/6 EL81 12/6 L22 8/6
6K8	9/-	EF39	7/6 EL40 10/- L25 12/6

**SPECIAL PRICE PER SET.**  
1R5, 1T3, 1R5, and 3S4 or 3V4 ... 27/6  
6K5, 6K7, 9Q7, 6V6, 3Z4 or 6X5 ... 35/-  
**SPEAKER FRET**—Expanded Bronze anodised metal 8in. x 8in., 2/3; 12in. x 8in., 3/-; 12in. x 12in., 4/3; 12in. x 16in., 6/-; 24in. x 12in., 8/6, etc.  
**TYGAN FRET** (Murphy pattern).—12in. x 12in., 2/-; 12in. x 18in., 3/-; 12in. x 24in., 4/-; etc., etc.

RADIO PARTS

Tubular Condenser .5 mfd. 500 v. 6d.	Each	Group tag Board. Any length	Each
Yaxley Switch 1 pole 8 way 1/4in. spindle 1/9		per inch..... 3/4d.	
Arrow Toggle Slotted Dolly S.P. 1/9		CV 21 Relay Valve in handle..... 6/-	
Single Screwned Cable.....yard 6d.		Condenser Clips. Assorted sizes	
Eric Mains Dropper 725 ohms		per dozen..... 3/-	
7 1/2 tapped..... 1/6		2 gang .00055 condenser..... 5/-	
Dubilier Moulded Mica AP9 .005 4 1/2		3 gang .0005 condenser..... 7/-	
HF Pile Wound Chokes..... 1/6		12 v. Vibrators, 4 pin T.C. .... 8/6	
Vibrator Clips..... 5d.		T.G.C. 10 mfd. 450 v. Wire ends 1/11	
International Octal Valve Holders		T.C.C. 24 mfd. 350 v. tag ends..... 2/6	
ers Paxofin..... 4 1/2d.		Cyclon Trimmers No. 26 2,500	
Vitreous Enamelled Resistors		pP..... 1/6	
20 w. 5,000 ohms..... 1/-		Paxofin Trimmers 100/50..... 6d.	
Dubilier 2 Meg. SPS slotted		Walter Trimmers 250/250..... 6d.	
spindle 2in..... 3/9		Ceramic Trimmers 100/100..... 6d.	
Assorted Resistors, 100 for..... 20/-		Ceramic Trimmers 80/400..... 6d.	
		B96 Ceramic Valve Holders..... 10d.	
		T.C.C. 100 mfd. 450 v..... 4/-	

**AMPLIFIER OR CHARGER CASE**  
Brown crackle cabinet with removable chassis, and bakelite front panel. Size 9 1/2" width x 7 1/2" height x 6 1/2" deep. 8/8 each.

**HEAVY DUTY OUTPUT TRANSFORMER**  
Suitable for PX4 or 6L6 valves in push pull. 12/- each.

**CHOKE**  
Wavoc choke, max. current 100 M/A D.C. Resistance 125 ohms 6/- each.

**MICROPHONE STAND**  
Folding microphone floor stand, adjustable. 25/- each.

**EXTENSION SPEAKERS**  
Deliant extension loudspeaker in attractive pale green cabinet. Volume control fitted, 6 1/2" speaker unit 42/- each.

**NUTS & BOLTS**  
Box of nuts, bolts and washers. 4BA countersunk and round head, over 100 items. 1/- box.

**WESTINGHOUSE, 1 M/A Rectifier.**  
wire ends. 8d. each.

ALPHA 3 VALVE T.R.F. KIT

£5.10.0

- ★ Easy to build.
- ★ Valves 6J7, 6K7, 6V8GT plus metal rectifier.
- ★ Walnut Cabinet.

Full instructions, point-to-point wiring diagram. Circuit diagram, and full shopping list 1/-. All components may be purchased separately.



SPECIAL OFFERS FOR ONE MONTH ONLY

- ★ Copper-plated plug-in aerial rods 12in. long. 4d. each.
- ★ Colvern CLR901 1,000/2, 1/9.
- ★ Colvern CLR901 10,000/2, 1/9.
- ★ VCR97 Tubes picture-tested. 20/- each. carriage 3/-
- ★ 1 lb. Cans of 3-core Solder. Resin core 8/6 reel.
- ★ I.F. Transformers. 465 kc/s Slug-tuned. Size 2 1/2in. x 1 1/2in. x 8/6 pair.



CONTROL KNOBS IN MODERN STYLING

Tastefully and clearly engraved in gold.

Size A. Diameter 1 1/2in. Depth 3/4in.

Size B. Diameter 1 1/2in. Depth 3/4in.

These Mouldings are available in two colours: Walnut and Ivory.

They are suitable for use with 1in. spindles and are simply and firmly held by means of a grub screw and locking nut.



Prices: Type "A"—1/6 each. Type "B"—1/2 each.

Plain Knobs can be supplied in either size or colour: Price 1/- each and 8d. each respectively. Descriptions available —

RADIO: "Volume," "V/On-Off," "Wave-change," "Tuning," "S.M.L. Gram," "Radio-Gram," "Tone," "On-Off," "TELEVISION: "Contrast," "Brilliance," "Brilliance/On-Off," "Focus," "Brightness,"

AMPLIFIER: "Trebble," "Bass" (plus any of those shown above). TAPF RECORDER: "Record-Play."

**TELETRON BAND III CONVERTER COIL SET**, for use with TRF and superhet Band I TV receivers (uses 2 7Z19). Circuit, wiring diagram, alignment details etc., etc., with each set. 15/- post extra.

**TELETRON FERRITE ROD AERIALS.** Med. Wave 5in. long. 8/9; Med. and Long Wave, 8in. long, 12/6.

Mail Order only. For terms see our advertisement on Page No. 651. WHEN ORDERING PLEASE QUOTE "DEPT. P.W."



5/6 VINCES CHAMBERS  
VICTORIA SQUARE  
LEEDS I.

FREE TO AMBITIOUS ENGINEERS!

This 144-page Book



**'ENGINEERING OPPORTUNITIES'** is a highly informative guide to the best-paid Engineering posts. It tells you how you can quickly prepare at home on "NO PASS—NO FEE" terms for a recognised engineering qualification, outlines the widest range of modern Home-Study Courses in all branches of Engineering and explains the benefits of our Employment Dept. If your earning less than £15 a week you cannot afford to miss reading this unique book. Send for your copy to-day—FREE.

\*\*\* FREE COUPON \*\*\*  
Please send me your FREE 144-page "ENGINEERING OPPORTUNITIES"

WHICH IS YOUR PET SUBJECT?

- Mechanical Eng
  - Electrical Eng
  - Civil Engineering
  - Radio Engineering
  - Automobile Eng
  - Aeronautical Eng
  - Production Eng
  - Building, Plastics, Draughtsmanship
  - Television, etc.
- GET SOME LETTERS AFTER YOUR NAME!
- A.M.I.Mech.E.
  - A.M.I.C.E.
  - A.M.I.P.E.
  - A.M.I.M.I.
  - L.I.O.B.
  - A.F.R.Ae.S.
  - B.Sc.
  - A.M.Brit.I.R.E.
  - CITY & GUILD'S GEN. CERT. OF EDUCATION etc., etc.

PROOPS BROS. LTD.

SOME OF THE MANY BARGAINS AT The Walk-around Shop

R.II32 RECEIVER

Suitable for conversion to F.M. Original Frequency 100 to 120 Mc/s. Valve line up: VR65 (2), VR66, VR67, VR53 (2), VR57. Switchable A.G.C. and A.V.C. Variable B.F.O. Circuit diagram with unit. Standard Rack Mounting. In first-class condition. £37.6, packing and carriage 15/- 10/- returnable on packing case.

TYPE 62a INDICATORS

Ideal for conversion to oscilloscopes, TV units, etc. Containing VCR97, Mumeta Screen, 12 VR91 (EF50), 4 CV118. Slow-motion dial, 13 Pots and scores of useful components. Size: 8 1/2in. x 1 1/2in. x 1 1/2in. New in wooden packing case. £3.0.0. Carriage 7/6.

MAKE A MINIATURE POCKET RADIO

Incorporating high "Q" technique using the New Ferrite rod. Made possible by simple conversion of an ex-Govt. Hearing Aid. £2.6.0 post paid, with circuit diagram and full instructions. Batteries extra: 1.5v. L.T. (Type D18) 8d.; 30v. H.T. Type B119, 4/3.

F.L.8 RADIO FILTERS 10/- ea., 1/6 p.p

R.F. UNITS

- R.F.24 20/30 Mc/s Switched Tuning, Fully Valved, 9/6 ea.
- R.F.25 40/50 Mc/s Switched Tuning, Fully Valved, 6/6 ea.
- R.F.26 50/65 Mc/s Variable Tuning, Fully Valved (Dials damaged). 15/- Packing and postage 2/- ea.

NOTE: ORDERS AND ENQUIRIES TO DEPT. 'P.'

NAME .....

ADDRESS .....

Subject or Exam. ....

that interests me .....

British Institute of Engineering Technology,  
409B, College House, 29-31, Wright's Lane,  
Kensington, W.8.



**PROOPS BROS. LTD.** Telephone LANgham 0141  
52 Tottenham Court Road, London, W.1.  
Shop Hours: 9-6 p.m. Thursday: 9-1 p.m. Open all day Saturdays

(Continued from page 690)

nominal frequency of the applied signal equals the tuned frequency of the associated transformer, both diodes conduct equally and equal voltages are developed across the two load resistors R1 and R2.

Since the diodes are connected back-to-front the voltages across the load resistors are added in opposition, and resolve to provide zero potential across the two cathodes.

When the frequency of the carrier deviates at a rate equal to the modulation frequency, the balance is upset, and a potential varying in sympathy with the modulation frequency is developed across R1 R2.

#### In Conclusion

As opposed to discriminators of other types, the

ratio detector has an inherent limiting function so far as AMPLITUDE variations of the signal are concerned. This is achieved by the "flywheel" effect given to the diode circuit by C1. Since its value is relatively large, C1 effectively absorbs rapid amplitude fluctuations of the applied signal.

The Foster-Seeley circuit is not endowed with this feature, and for this reason the use of this circuit nearly always calls for a limiter stage at the end of the I.F. chain.

Slightly less distortion at maximum deviation is generally created in the Foster-Seeley discriminator, as compared with the ratio detector, but even so the ratio detector appears to be favoured in view of its valuable limiting action.

## News from the Clubs

### BARNSELEY AMATEUR RADIO CLUB

Hon. Sec. : P. Carbutt (G2AFV), 33, Woodstock Road, Barnsley. The club is holding an Open Night on the evening of October 14th, and on October 28th the evening will be under the charge of W. Richardson (G8VX).

Club subscriptions are 7s. 6d. for adults and 2s. 6d. for juniors annually. Lectures are given at the King George Hotel, Peel Street, Barnsley.

### HAWICK RADIO SOCIETY

Hon. Sec. : G. Shankie, 17, Etrick Terrace, Hawick, Roxburghshire.

THE Society commenced its winter season on September 15th in the club rooms at 13, Wilton Crescent, Hawick. It is hoped to have soon a transmitter in operation under the call sign of GM3FHS. All interested visitors will be made most welcome.

### LOTHIAN RADIO SOCIETY

Hon. Sec. : J. Good (GM3EWL), 24, Mansion House Road, Edinburgh, 9.

THE following events will be held during October :

October 6th.—Bring and Buy Sale.

October 20th.—"T.V.I. Proofing," recorded lecture by R. L. Varney (G5RV).

October 29th.—Visit to B.B.C. transmitter at Westerglen. (Full details of this visit are available from the secretary.)

### TORBAY AMATEUR RADIO SOCIETY

Hon. Sec. : L. H. Webber (G3GDW), 43, Lime Tree Walk, Newton Abbot.

**BERN SYMONS** is out of hospital and hopes to be with us again soon.

Derek Webber has been presented by the Society with an electric clock on the occasion of his recent marriage, with good wishes from us all.

G3AVF is continuing experiments with V.H.F., in conjunction with G3GOA. He hopes to report more fully at a later date, specially in connection with "pulse" transmissions. The first of the R.S.G.B. recorded lectures, "V.H.F.," by Sir Noel Ashridge, was booked for the meeting on 17th September.

### RAVENSBORNE AMATEUR RADIO CLUB

Hon. Sec. : J. H. F. Wilshaw, 4, Station Road, Bromley, Kent.

THE club meets every Wednesday evening at 8 p.m. in the Science Room, Downham Men's Institute, Downham, Kent. (Buses 124, 69 and 169 pass near the door).

Meetings were resumed on September 7th after the summer holidays and members, including G2DHW and G3FTI, operate the new TA12, 40-watt transmitter on the 80, 40, 20 metre bands with the call sign of G3HEV. Another 25-watt transmitter is available for 80 metres (and 160 phone) and a R1155 receiver together with an all-wave signal generator is also available.

An exhibition of home-constructed gear will be held at the Institute

next May when all equipment will be operational. The club has a good supply of books and quite a number of QSL cards for display together with photographs taken on various events. Contests with the club station are held, including an annual field day with a portable transmitter.

New members are welcome to come along any Wednesday evening, the subscription being 1s. 6d. per annum.

### THE EXPERIMENTS CLUB

Hon. Sec. : B. Smith, 9, St. Margarets Road, Westgate-on-Sea, Kent.

THIS recently formed club is for experimenters under the age of twenty-one. Membership is open to anyone interested in radio, chemistry and astronomy.

At the moment the club has about a dozen members and more are needed before a club magazine can be produced. Members are invited to send in articles and ideas to the secretary, drawings to be made in Indian ink. Both original and tracing should be sent with each article. Application forms for membership are also available from the secretary. (Send stamped, addressed envelope).

### DURBAN RADIO AND TELEVISION SOCIETY

Hon. Sec. : N. A. Brokenshaw, 43, Powell Road, Durban, South Africa.

AT the recent Hobbies and Crafts Fair held in Durban, attended by about 100,000 people and resulting in profits at around £10,000, a special stand was devoted entirely to Amateur Radio.

The stand was a joint effort between the South African Radio League, Durban Branch, and the Durban Radio and Television Society. The exhibits were designed to present the general aspects of the hobby to the public.

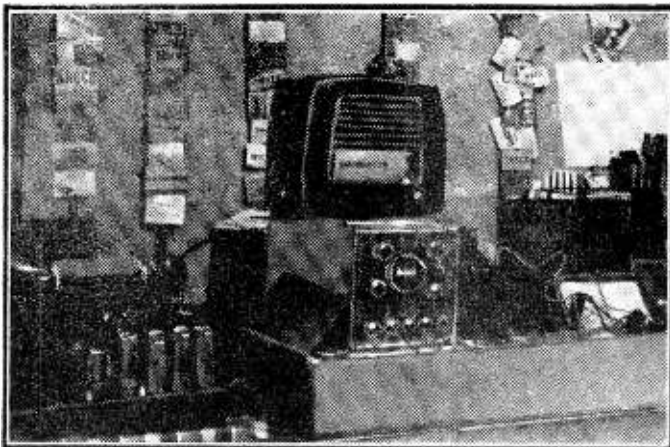

A section of the radio stand run by the Durban Society at the recent Durban Hobbies and Crafts Fair. Call-sign cards can be seen on the wall behind the apparatus.

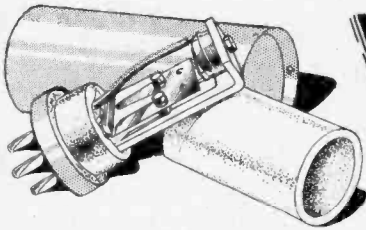

# VIBRATORS

SOME USEFUL INFORMATION ON THE IDENTIFICATION AND SELECTION OF EX-W.D. EQUIPMENT

By G. J. Hudson

As many vibrators are on sale in ex-W.D. stores, the information given here may help in choosing purchases, or in identifying those which have found their way into the "spares box," for constructors who wish to build their own units.

### Useful Notes

After long storage vibrator contacts become oxidised and may fail to start. A sharp knock may free the contacts or, if not, a suitable A.C. supply connected across the driving coil will cause the reed to vibrate. In an emergency the aluminium case can be opened to clean the contacts by hand (using extreme care!).

Never remove or replace a vibrator when the equipment is switched on as this may damage the vibrator.

Always ensure that the vibrator case is securely earthed to the chassis, and it is advisable to shield the power unit from the rest of the equipment to reduce interference.

Resistors and condensers should be connected across the main contacts of the vibrator, the former to prevent complete open circuit during operation and the latter for arc suppression at the contacts. The

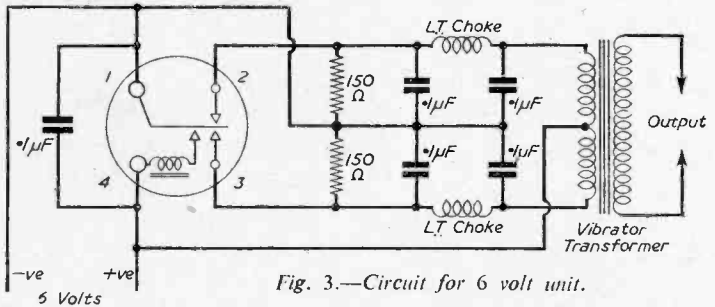

Fig. 3.—Circuit for 6 volt unit.

resistors are usually 150 ohms for a 6-volt supply and 300 ohms for a 12-volt (see Fig. 3).

If using a vibrator unit in a car, check polarity of battery to earth and that of electrolytic condensers in the unit as many vehicles have positive earth and most vibrator units have negative earth. Sometimes reversible electrolytics are found in the units.

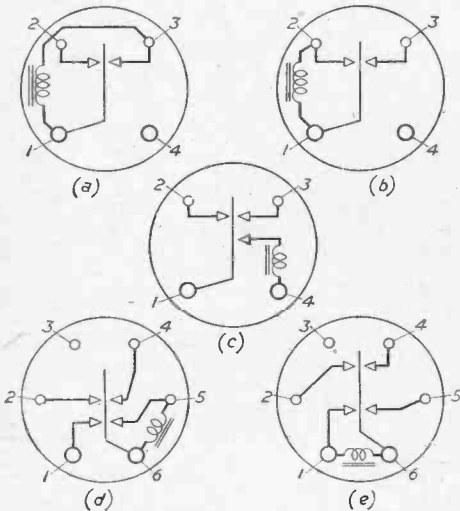

Fig. 1.—Base connections of some common types of vibrators viewed from underneath, bases being 4 pin U.X. and 6 pin U.X. (the letters in brackets refer to types in Fig. 2).

Type	Volts	Amps.	W. D. No.	Makers Name & Number
(a)	6	4	ZA.21341	Weare & Wright N/S/B/6
(a)	12	3	—	N/S/B/12
(b)	6	5	ZA.6779	Mallory 650, 850, 659
(b)	12	3	ZA.27012	Mallory G629C (sealed)
(b)	12	3	ZA.4878	Mallory G650
(c)	12	3	—	Weare & Wright N/S/12
(c)	6	4	—	Oak V6512
(c)	6	4	—	Weare & Wright N/S/6
(c)	6	4	—	Oak V6506
(c)	24	?	—	Weare & Wright N/S/24
(c)	12	3	—	Oak 6122
(c)	12	3	ZA.13718	Oak 18XH, V6121, V5123
(c)	6	4	ZA.13881	Oak 17XH, V6123
(d)	6	?	ZA.7019	Bulgin HTV 117
(e)	6	7	—	Oak V5124, Mallory 560

Fig. 2.—Types of Vibrators.

**Our Latest Handbook**

**A BEGINNERS GUIDE TO RADIO**

By F. J. CAMM 7/6, by post 7/10

From

**GEORGE NEWNES, LTD.,**

Tower House, Southampton Street, Strand, W.C.2.



**C.R.T. ISOLATION TRANSFORMERS**

**Type A.** Low leakage windings. Ratio 1:1.25 giving a 25% boost on Secondary. 2 v., 10/6; 4 v., 10/6; 6.3 v., 10/6; 10.8 v., 10/6; 13.3 v., 10/6.

**Type B.** Mains Input 220/240 volts. Multi Output 2, 4, 6.3, 7.2, 10 and 13 volts. Input has two taps which increase output volts by 25% and 50% respectively. This transformer is suitable for most Cathode Ray Tubes. With Tag Panel, 21/- each.

**Type C.** Low capacity wound transformer for use with 2 volt Tubes with falling emission. Input 230/240 volts. Output 2.24-2.1-2.3 volts at 2 amps. With Tag Panel, 17/6 each. All Isolation Transformers are individually boxed, labelled and clearly marked with relevant data.

**TRIMMERS.** Ceramic, 30 50, 70 pf., 9d., 100 pf., 150 pf., 1/6; 250 pf., 1/6; 600 pf., 750 pf., 1/9.

**RESISTORS.** All values. 10 ohms to 10 meg., 1 w., 4d.; 1 w., 6d.; 1 w., 8d.; 2 w., 1/1.

**HIGH STABILITY.** 1 w. 1%, 2/-; Preferred values 100 ohms to 10 meg.

**WIRE-WOUND RESISTORS** (1/3 10 watt, 25 ohms—10,000 ohms..... 1/8 15 watt) 2/- 15,000 ohms—50,000 ohms, 5 w. 1/8; 10 w. ...2/3

**RECORDING TAPE**

1,200 ft. on standard fitting 7" Plastic reels. Brand new boxed 17/6.

**O.P. TRANSFORMERS.** Heavy Duty 50 mA., 4/6. Ditto, tapped primary, 4/9. Multiratio, push pull, 6/8. Tapped small pentode, 3/9. Miniature 3584, etc., 3/9.

**L.F. CHOKES** 15/10 H. 60/65 mA., 5/-; 25/20 H. 100/120 mA., 11/6; 20/15 H. 120/150 mA., 12/6.

**MAINS TRANS.** 350-0-350, 80 mA., 6.3 v. tapped 4 v. 4 a., 5 v. tapped 4 v. 2 a., ditto 250-0-250, 21/-.

**MIDGET** 250-0-250 v. 20 mA., 6.3 v. 2 a., 12/6.

**HEATER TRANS.** Tapped prim. 200/250 v. 6.2 v. 14 amp., 7/6; tapped sec. 2, 4, 6.3 v., 11 amp., 8/6.

**CRYSTAL MIKE INSERT.** Famous make, precision engineered. Size only 1 1/2" x 3/16". Bargain price, 6/6. No transformer required.

**COPPER PLATED AERIAL RODS.** 1/2 x 12in. push fitting, 2/6 (oz., p. & p. del. Aerialite Earth rods, 4/-).

**ALADDIN FORMERS** and core, 1in., 8d.; 1in., 10d.

**TYANA—Midget Soldering Iron.** 200/220 v. or 230/250 v., 14/11. Triple Three mod. with detachable bench stand, 19/6. Solon Midget Iron, 22/-.

**MIKE TRANS.** Ratio 50 : 1, 3/9 ea., new.

**WAKE DROPPERS.** 3 x 1 1/4in. Adj. sliders, 3 amp., 750 ohms, 4/3; 2 amp., 1,000 ohms, 4/3.

**LINE COORD.** .3 amp., 60 ohms, per foot, 2 amp., 100 ohms per foot, 2 way, 6d. per foot, 3 way, 7d. per foot.

**LOUDSPEAKERS P.M. 3 OHM.** 5in., 16/8; 6 1/4in., 17/6. (Coolmans Elliptical 7 x 4, 15/6; 8in., 19/6; 10in., 25/-; 6 1/4in. Coolmans with trans., 21/-; 4in. Mains energised 2.5 K. or 2 K. ohm field, with tapped output trans., 24/6; less trans., 21/-; 12in. Lightweight Plessey, 30/-).

**CRYSTAL DIODE.** G.E.C. 3/6. Circuit Book, 1/-.

**HIGH RESISTANCE HEADPHONES.** 4,000 ohms, 15/6 pr.

**COPPER ENAMEL WIRE.** 1lb. to 16 to 20 s.w.g., 2/-; 22 to 28 s.w.g., 2/6; 30 to 40 s.w.g., 3/6.

**SWITCH CLEANER.** Fluid, squirt sprout, 3/9 tin.

**TWIN GANG TUNING CONDENSERS.** .006 mfd. midget with trimmers, 8/6; .375 pf. midget, less trimmers, 6/6; .0005 Standard size with trimmers and feet, 9/-; less trimmers, 8/-; ditto, soiled, 2/6.

**SPEAKER FEET.** Woven Plastic T.G.A. Walnut tone, 12in. wide, 2/- per foot. Expanded metal, gold or Silver, 9 1/2 x 12in., 2/- each.

**VALVES**

A SMALL SELECTION FROM OUR STOCKS

All Boxed		New & Guaranteed	
6/6	EA50	3/6	2/6
6A15	1/8	3D6	5/6
6B5	6H6M	2X2	6A65
6K7G	7/6	7/6	6B8
EB91	6Z4	6P6	12B150
8/6	1R5	6K6	10/6
6AC7	1T4	6BA7	6AM6
6AT6	184	6NL7	6L32
6C9	384	6V6G	HV22A
6L6G	3T4	6X4	12Z
68N7	6BE6	6X5	1P41
787	6BW6	12AX7	VP23
EC48			12K7
12/6			12K8
EY51			25Z4
			35L9

Send Stamp for Full Valve List. All B.V.A. Types at 1951 Low Tax Prices.

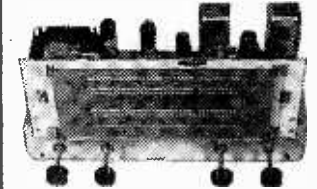

**ALL WAVE RADIOGRAM CHASSIS**

THREE WAVEBANDS FIVE VALVES

8. W. 16 m.—50 m. LATEST MULLARD M. W. 200 m.—550 m. ECH42, EP41, EBC41, L. W. 800 m.—2,000 m. EL41, E2350.

12 month guarantee, with 10in. P.M. Speaker. A.C. 200/250 v. 4-wax Switch; Short-Medium-Long-Gran. A.V.C. and Negative feedback. 4.2 watts. Chassis 13 1/2 x 5 1/2 x 2 1/2in. (Glass Dial 10 x 4 1/2in. horizontal or vertical available. 2 Pilot Lamps. Four Knobs, Walnut or Ivory aligned and calibrated. Chassis isolated from mains.

£10.15. Less Speaker, 29/15/-.

RECOMMENDED FOR ABOVE CHASSIS

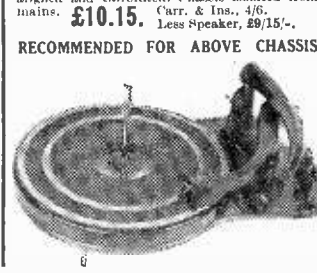

**£8-19-6 (Limited Period)**

Brand new Plessey 3-speed Autochanger Mixer Unit for 7, 10 and 12in. Records. Twin Hi-Fi Xtal Head with Duoport sapphire stylus. Plays 4,000 records. Spring mounting. Baseboard required 15 1/2 x 12in. Height 5 1/2in. Depth 2in. Super Quality. Post free.

FAMOUS MAKE. 3-speed Single Record unit with Acos 37 Turnover Head, each Sapphire Stylus plays 2,000 records. Starting Switch Automatically places Pick-up on records, 7in., 10in. or 12in. Auto Stop. Baseplate 12 x 8 1/2in. Height 2 1/2in. Depth 1 1/2in. Price 27/15/6, post free.

B.S.R. MONARCH 3-SPEED MIXER CHARGER ACOS GP-37 XTAL HEADS. Baseboard 14 x 12in. Height 7 1/2in. Brand new in Makers' Boxes. 29/19/6, post free.



24/19/6. CONVERT YOUR RADIO. Playing desk 15 x 22 x 7 1/2in. Walnut finish, drawer front with 78 r.p.m. motor, turntable and pick-up. Press lever start places High Impedance Magnetic pick-up on records 10in. or 12in. Auto Stop. Brand new in original makers' boxes. 200,250 v. A.C. 24/19/6, carr. free.

SUPERHET COIL PACK 27/6 Miniature size 2 1/2 x 2 1/2 x 1 1/2in. High Q dust core coils. SHORT, MED., LONG, GRAM. switching with connection diagram and circuit.

**BAND 3 T.V. CONVERTER KITS**

Suitable all T.V. makes. T.R.F. or Superhet. Ready wound coils, B.V.A. valves, all components, punched chassis, circuit diagram, wiring plans. COMPLETE KIT for mains operation 200/250 v. A.C. 29/10/0.

AN ABOVE LESS POWER PACK. Requires 200 v. 20 mA. H.T. 6.3 v. 1 a. L.T. 22 1/2 v.

PINCHED CHASSIS and WOUND COILS, component list, circuit diagram, wiring plans, only 19/6.

**80 ohm COAXIAL CABLE**

Semi-ir spaced Polythene insulated, 1/2in. dia. Stranded core. Losses cut 50%, 8d. yd.

Standard 1/2in. Coaxial, 7d. yd. BALANCED TWIN FEEDER, yd. 8d. 80 or 200 ohms. DITTO SCREENED per yd. 8d. 80 ohms.

50 OHM COAXIAL CABLE 8d. per yd. 1/2in. dia. COAX PLUGS 1/- DOUBLE SOCKET 1/6 SOCKETS 1/- OUTLET BOXES 3/6

Volume Controls. Long spindles. Guaranteed 1 year. All values 10,000 ohms to 2 Meg. No Sw. 8/-, S.P.Sw. 4/-, D.P.Sw. 4/9.

WIRE-WOUND POTS, 3 WATT FAMOUS MAKES. Pre-Set Min. T.V. Type. All values 25 ohms to 30 K., 3/- ea. 50 K., 4/-. Ditto Carbon Track 50 K. to 2 meg., 3/-. Standard Pots, 2 1/2in. Spindle. All Values, 100 ohms to 50 K., 5/6; 100 K., 6/6.

VVV EXT. SPEAKER CONTROL, 10 ohm 3/-.

T/V PRE-AMP. Channel 1. Midget Chassis 4 1/2 x 2 1/2 x 1 1/2in. with EF42 or 6P13 valve, coaxial lead, Belling plug and Output plug. Ready for use. Brand new. Special Price, 21/-.

CONDENSERS. New stock. .001 mfd. 7 kv. T.C.T., 5/6. Ditto, 12.5 kv., 9/6. 2 pf. to 500 pf. Micaps, 6d.; Tubular 500 .001 to 100 mfd., 9d.; .01, .1, 1/-; .25, 1/4; .5, 1/9; .1/350 v., 9d.; .1, 600 v., 1/3; .1/1,500 v., 3/6.

CERAMIC CONDS., 500 v., .3 pf. to .01 mfd., 1/-.

SILVER MICA CONDENSERS—106, 5 pf. to 500 pf., 1/-; 600 pf. to 3,000 pf., 1/3. DITTO 1 v. 1.5 pf. to 500 pf., 1/9; 315 pf. to 1,000 pf., 2/-.

**I.F. TRANSFORMERS**

Weatrite type 500 465 kc's. 10/6 pair.

TUBULAR	CAN TYPES	CAN TYPES -
2/450 v. 2/3	16/500 v. 4/-	8+16/450 v. 5/-
5/500 v. 2/8	200/12 v. 3/-	32+32/350 v. 4/6
16/500 v. 4/-	SCREW BASE	32+32/450 v. 6/6
25/25 v. 1/9	TYPE 512	60+100/250 v. 11/6
50/50 v. 2/-	8/500 v. 3/-	1,000+1,000/50 v. 6/6
100/25 v. 2/-	16/500 v. 4/-	15,000 v. 4/6

SENTERCEL RECTIFIERS. E.H.T. TYPE FLY-BACK VOLTAGES. K3/25 2 kv., 4 3/4; K3/40 3.2 kv., 6/-; K3/45 3.6 kv., 6/6; K3/50 4 kv., 7/3; K3/100 8 kv., 12/6; MAIN TYPE. R.M. TYP. R.M., 60 mA., 4/-; R.M2, 100 mA., 4/9; R.M3, 120 mA., 5/-; R.M4 250 v. 275 mA., 16/-; T.V. AERIALS Band I. Indoor Inv. T. 13/6.

Band 3 Dipole indoor, 7/6.

**2/6 SPECIAL CLEARANCE 2.6 BRAND NEW SUB MINIATURE VALVES**

Ex Beat Aid Apparatus

0.25 v. Fil.	I.F. Pentodes	1.25 v. Fil.
XFW 10	HIVAC	
DP70	MULLARD	DL72
505AX	RAYTHEON	505AX
		507AX

COILS. Weatrite. "P" type, 2/6 each. 0-mur Midget "Q" type adj. dust core, 3/6 each. \* All ranges. H.F. MIDGET CHOKES. 14 M.H. 2 6 each.

ALUMINIUM CHASSIS. 18 s.w.g. 3 1/2in. undrilled, folded 4 sides and riveted corners lattice fixing holes. Strong and soundly constructed with 2 1/2in. sides. 7 x 4in., 4/6; 11 x 7in., 6/8; 18 x 9in., 8/6; 14 x 11in., 10/6; 18 x 16 x 3in., 16/8.

FULL WAVE BRIDGE SELENIUM RECTIFIERS. 2.6 or 12 v. 1 1/2 amp., 8/9; 2 a., 11/3; 4 a., 17/6. CHARGER TRANSFORMERS. Tapped (input 200/250 v. for charging at 2, 6 or 12 v., 1 1/2 amp., 13/6; 4 amp., 21/-).

ACID HYDROMETER. New Ex Govt. Unbreakable. Packed in metal case 7 x 1 1/2in. dia., 4/6.

F.M. TUNER COIL KIT, 27/6. I.F. coil, Aerial coil, Oscillator Coil, two I.F. Transformers 10.7 Mc/s. Detector transformer and heater choke. With circuit and component list for popular F.M. Tuner using four 6AM6 valves and standard components.

We have no connection with any other firm. Please address all correspondence correctly as below.  
**RADIO COMPONENT SPECIALISTS 307 WHITEHORSE RD., WEST CROYDON**  
 OPEN ALL DAY—(Wed. 1 p.m.) 10 page list S.A.E.  
 Tel. THO 1665, after 6 p.m. 4198. Buses 133 or 68 pass door. 48-hour postal Service. P. & P., 6d. £1 orders post free. C.O.D. Service 1/6

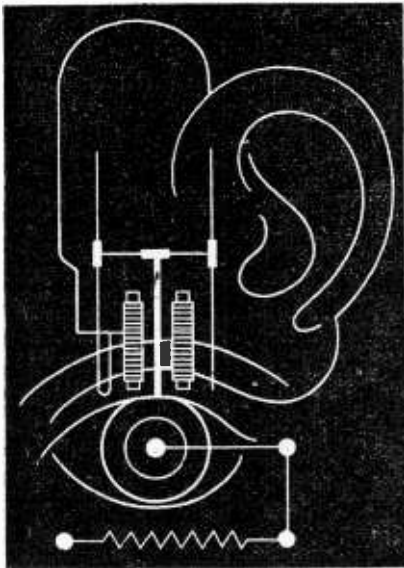

## SMITH'S FOR TECHNICAL BOOKS

Books on radio theory, practice and maintenance for the beginner and books on new developments in circuit design, new components, methods of application, and the established text books can be obtained through your local Smith's shop or book-stall. Books not in stock at the branch can be quickly obtained from Head Office.

★  
*Your stationery and  
printed matter can also be  
supplied through our  
local branch.*

## W. H. SMITH & SON

FOR BOOKS ON ELECTRONICS

Head Office: STRAND HOUSE, LONDON, W.C.2

## "You can rely on us"

LARGE STOCKISTS OF RADIO AND  
ELECTRONIC COMPONENTS

H.P.  $\bar{o}$ n INSTRUMENTS, "912" and  
MULLARD AMPLIFIER KITS, SOUND-  
MASTER, VIEWMASTER, Etc., Etc.

RESISTORS — STANDARD, MIDGET,  
HIGH STABILITY, PRECISION;  
TAPPED VOL. CONTROLS, Etc., Etc.

SEND FOR LIST.

Proprietary catalogues available to Manu-  
facturers' Laboratories, Education Authorities,  
etc.

## RADIO SERVICING CO.,

82, SOUTH EALING ROAD,  
LONDON, W.5.

EAL 5737

## VESPA TWO SPEED TWIN TRACK Tape Deck

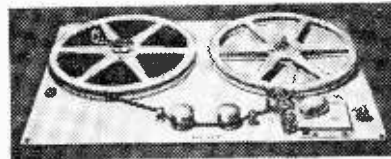

Model 521. Compact Deck, 7½ in. x 11 in.  
5 in. Reels. Kit ... .. £7 10. 0.

Model 721. Standard Deck, 10½ in. x 15 in.  
7 in. Reels. Kit ... .. £8 10. 0

EASY TO ASSEMBLE, PRECISION MACHINED PARTS,  
SUPER HIGH QUALITY FERROXCUBE HEADS, FINEST  
MOTORS, FULL ASSEMBLY DRAWINGS.

Either Deck fully built and tested 27/6 extra.

**BUILD YOUR OWN**  
High Quality Tape Recorder with Vespa  
Tape Deck Kit and the New Amplifier Kit,  
Record/Replay.

**MAKE YOUR OWN TAPE RECORDINGS**

BE READY FOR CHRISTMAS

Send stamp for full details.

**W. S. ASPDEN** 10, Market St., Wesham,  
KIRKHAM, LANCs.

# Conversion of D.C. Voltage

SOME USEFUL NOTES ON THE USE OF D.C. MOTOR GENERATORS AND ROTARY TRANSFORMERS

By J. L. Watts

THERE are often occasions when it is required to supply direct-current apparatus, which is rated for a certain voltage  $V$ , from a D.C. supply of higher voltage  $V_1$ . In some cases it is quite satisfactory to do this by connecting a resistor, of value  $R$  ohms, in series with the apparatus. There are however, certain disadvantages of a series resistor which make this method very uneconomic, and in some instances unsuitable. In the first place, if the apparatus takes a current of  $I$  amps there will be a waste of power in heat at the series resistor, this power being equal to  $I^2R$  watts. This loss may be considerable if an appreciable reduction of voltage is required,  $R$  being equal to  $\frac{V_1 - V}{I}$  ohms. Secondly,

if the load current varies there will be a variation of the volt drop across the series resistor, this volt drop being equal to  $I \times R$  volts; so that the voltage across the load, which is equal to  $V_1 - (I \times R)$  will also vary. In consequence a series resistor is not a satisfactory method of providing a considerable reduction of voltage to a motor which works on a varying load. If the load on such a motor was reduced the voltage applied to the motor would automatically rise, and this might break down the insulation of the commutator or armature windings, or burn out shunt-connected field windings. In addition the motor speed would rise and there would be increased centrifugal stresses on the rotating parts, proportional to speed<sup>2</sup>, which might damage them.

## D.C. Motor Generators

A simple method of obtaining a steady voltage of different value to the supply voltage, whether of higher or lower value, is by means of a motor-generator comprising a D.C. motor of supply voltage which drives a dynamo of the required voltage. The voltage output of this set can be controlled by means of a variable resistor connected in the shunt field circuit of the dynamo. Provided that the driving motor is designed to run at practically a constant speed, and the correct type of dynamo is used, the terminal voltage of the dynamo on a given setting of its field regulating resistance may be almost independent of the load current taken from the set. A shunt motor has a slight fall of speed from no load to full load, but a differential compound motor can be designed to run at almost a constant speed over its full range of load.

If the dynamo used is a shunt machine its terminal voltage will fall slightly from no load to full load. This is due to the resistance  $R_A$  of the armature windings, which cause a volt drop equal to  $I \times R_A$  volts in the armature when the load current  $I$  amps passes through them. In addition armature reaction on load tends to weaken the field magnetic flux slightly and thus reduce the voltage generated in the dynamo. Armature volt drop can be compensated for if a cumulative-compound dynamo is used; in addition to the shunt field coils this machine also has series-connected field coils through which the armature current flows to maintain or strengthen the field

flux on increased load, to maintain or increase the generated voltage. Larger dynamos may also have compensating windings fitted in slots in the field pole shoes to overcome armature reaction.

It should be noted, however, that if the speed of the driving motor falls on increased load the voltage output of the driven dynamo may also fall considerably, thus it is very desirable that a "constant-speed" motor be used. Fall of motor speed may also be expected if the driving motor is overloaded due to it not being large enough to drive the dynamo on full load. Thus it is important that a motor-generator set should be provided with a motor of adequate size. The watts output of a dynamo is equal to  $V \times I$  watts, where  $V$  is the terminal voltage of the dynamo and  $I$  the load current (amps). The electrical equivalent of the horse power required to drive the dynamo on this

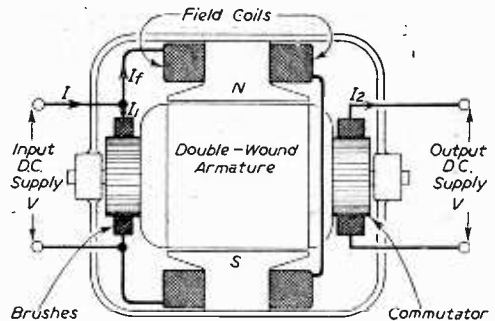

Diagram of a rotary transformer.

load is equal to  $\frac{V \times I}{e}$  watts, where  $e$  is the efficiency of the dynamo. For machines of normal design the following values may be taken for the efficiency  $e$  on full load: 0.67 for 500 watts, 0.75 for 1,000 watts or 1 kW, 0.76 to 0.79 for 2 to 5 kW, 0.8 to 0.85 for 6 to 10 kW, 0.88 for 15 kW, 0.9 for 20 to 30 kW, 0.91 for 35 to 50 kW and 0.93 for 100 kW. The brake horsepower required at the motor shaft to drive the dynamo when delivering a current of  $I$  amps at  $V$  volts will be equal to  $\frac{V \times I}{746 \times e}$ .

The economical operation of a motor-generator set as compared with a series resistor is most apparent when a considerable reduction of voltage is required, as in the case of charging an accumulator from D.C. mains. Consider the case where 10 amps charging current is required at 15 volts from 230 volt D.C. mains. The power to be supplied to the battery is equal to 15 volts  $\times$  10 amps = 150 watts. If a series resistor were used this would require to have a value of  $\frac{230 - 15 \text{ volts}}{10 \text{ amps}} = 21.5$  ohms. The power loss in the series resistor, equal to  $I^2R$ , would be  $10^2 \times 21.5 = 2,150$  watts. The efficiency of the charger is equal to  $\frac{\text{Output watts}}{\text{Input watts}} = \frac{150}{2,300} = 0.065$ , or 6.5 per cent.

The same output might be obtained from a D.C. dynamo having an efficiency of about 50 per cent., in which case the electrical equivalent of the mechanical input to the dynamo would be  $\frac{150 \text{ watts}}{0.5}$

$= 300 \text{ watts}$ . The horse-power equivalent is equal to  $\frac{300 \text{ watts}}{746}$

of 150 watts was driven by a  $\frac{1}{2}$  h.p. D.C. motor from the 230 volt D.C. supply, this motor may have an efficiency of about 0.6 when run at the reduced loading of 0.4 h.p. In this case, the electrical input to the motor, with the dynamo loaded to 10 amps at 15 volts, would be equal to  $\frac{\text{watts output of motor}}{\text{efficiency of motor}}$

$= \frac{300 \text{ watts}}{0.6} = 500 \text{ watts}$ . The overall efficiency of the

motor generator set is equal to  $\frac{\text{watts output of dynamo}}{\text{watts input to motor}}$

$= \frac{150}{500} = 0.3$  or 30 per cent., which is nearly five times as great as in the case of a simple series resistor.

It may also be mentioned that a motor generator can be used to give an A.C. supply from a source of D.C. In this case a D.C. motor of supply voltage would be used to drive an A.C. generator or alternator of the required voltage and the required number of phases; if required the field coils of the alternator could be energised from the D.C. supply. Whilst the speed of a D.C. motor-generator is unimportant, provided the motor drives the dynamo at the speed for which the latter was designed, the speed of an alternator governs the frequency of the A.C. output as well as the A.C. voltage. In order to generate A.C. at a frequency of  $f$  cycles per second the alternator must be driven at  $\frac{f}{P}$  revs. per second,

where  $P$  is the number of pairs of poles for which the alternator is wound. If the speed of the driving motor falls on load the A.C. voltage generated and the frequency will thus fall in the same proportion, whilst the terminal voltage of the alternator may fall to a greater degree due to the resistance, reactance and reaction of its armature. Thus a constant speed motor is highly desirable.

#### Rotary Transformers

The efficiency of a D.C. to D.C. motor-generator is equal to the product of the efficiencies of the motor and dynamo. Still greater efficiency of D.C. to D.C. voltage conversion, whether up or down, can be effected by using a single machine called a rotary transformer. As shown on page 697 the rotary transformer has a single field system, with its field coils energised from the D.C. supply of voltage  $V$ . The armature has two sets of windings, one of which is fed from the D.C. supply through a commutator and brushes, whilst the other armature winding provides the output at the required D.C. voltage through a second commutator and brushgear.

The ratio  $\frac{\text{output voltage}}{\text{input voltage}}$  is governed by the ratio of the number of turns in the respective armature windings, and cannot be varied by variation of the field current as is the case with a motor-generator set. When the machine is running the two sets of armature windings generate E.M.F. (voltage) as they cut the magnetic flux from the field magnets. On the input

side the E.M.F.  $E_1$  in the primary armature windings acts as a back E.M.F. and opposes the supply voltage  $V$ , as in the case of an ordinary D.C. motor. If  $E_1$  is the back E.M.F. generated in the primary armature windings at a given speed this will be equal to  $V - I_1 \times R_1$ , where  $I_1$  is the current through the primary armature winding (amps.), and  $R_1$  the resistance of this primary winding. At the same speed the E.M.F.  $E_2$  generated in the secondary armature winding of resistance  $R_2$  ohms will be equal to  $\frac{E_1 \times T_2}{T_1} = \frac{T_2 \times (V - I_1 \times R_1)}{T_1}$ , in which

expression  $T_2$  is the number of turns in series in the secondary (output) armature winding, and  $T_1$  is the number of turns in the primary armature winding. The resistive volt drop in the secondary armature winding, of resistance  $R_2$  ohms, when carrying the load current  $I_2$  amps. will be equal to  $I_2 \times R_2$  volts; thus the output terminal voltage  $V_2$  on load will be  $E_2 - I_2 \times R_2 = \frac{T_2}{T_1} (V - I_1 \times R_1) - I_2 \times R_2$ . Thus the

ratio of voltage transformation  $\frac{V_2}{V}$  will be equal to  $\frac{T_2 (V - I_1 \times R_1) - T_1 (I_2 \times R_2)}{T_1 \times V}$ . The rotary trans-

former may be started up by means of a simple motor starter, which may have a graduated resistor which is connected in the armature circuit at starting.

## Electronic Brain

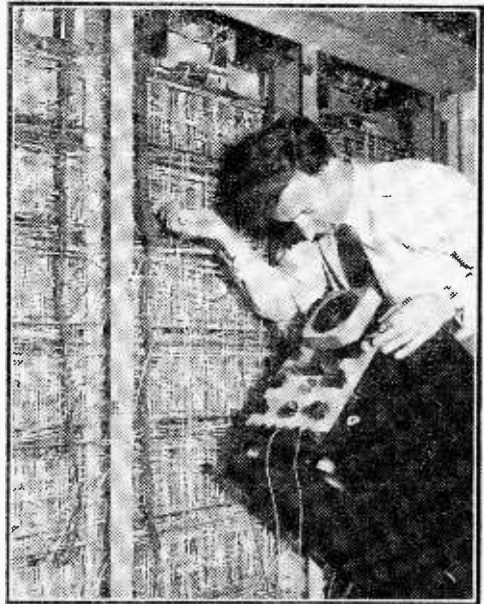

This "electronic brain" is the Elliott 402, manufactured by Elliott Brothers of Boreham Wood, Herts. It can solve mathematical problems in one hour which by normal methods would take two years. Costing £25,000 to construct, the computer contains 620 valves, has 100,000 soldered connections and uses seven miles of wire, although requiring no more power than two domestic cookers.

# SUPERIOR RADIO SUPPLIES

## SUPERIOR BUREAU



An elegant cabinet in richly figured walnut veneer, internal panels in polished sycamore. A drop front lid covers a sloping, uncut control panel (14in. long x 10 $\frac{1}{2}$ in. high) alongside which is an uncut base-board (17 $\frac{1}{2}$ in. long x 13 $\frac{1}{2}$ in. back to front). The inside of the drop front lid is paneled in beige leatherette. In the lower part of the cabinet are two large storage cupboards (13 $\frac{1}{2}$ in. high, 7 $\frac{1}{2}$ in. wide, 16 $\frac{1}{2}$ in. deep). The lid and cupboard handles are in chased Florentine bronze. Overall dimensions (33in. high, 24in. long, 16 $\frac{1}{2}$ in. deep). Price £17.0.0., plus 15/- cart. Send for Cabinet Leaflet.

**TERMS:** Cash with order or C.O.D. Extra charge for C.O.D. U.K. and N. Ireland only.

**(PW/N) 37, HILLSIDE, STONEBRIDGE, LONDON, N.W.10.**

## DULCI BAND 3 T.V. CONVERTER

★ ★ Type I.K.O. Patents ★ ★

A complete self-contained unit, suitable for converting all makes of T.V. Housed in a polished wood cabinet size 7in. x 10in. x 5 $\frac{1}{2}$ in. All channels are iron core tuned with pre-set adjustments. Input signal equalising is provided. Valves Z77, Z77, 12AX7, 6X4. Power supply, A.C. Mains 200/250 volts. Service Data available on request. Price £9.15.0. Plus 3/6 post and packing.



## F.M. & A.M./F.M. CHASSIS

Send for details of the latest types of High Quality V.H.F. Tuners and Amplifiers suitable for Band 2. Also, complete 4 Wave-Band 9 Valve Push-Pull A.M./F.M. Quality Radiogram Chassis.



## DISC PLAYERS

Specially designed for the HI-FI enthusiast and home constructor. These Disc Players consist of the latest Three-Speed Automatic Record Changer, complete with crystal turn-over pick-up head for long-playing and standard records. This unit is mounted on a Sycamore veneered base which is complete with fitted Mains lead, and screened Pick-up lead, ready for connecting up. Brand new and boxed. Price £10.16.0. Plus 5/- Post and Packing.

## THE "SUPEREX 55" ATTACHE PORTABLE

Building Cost £7.15.0. plus 3/6 P.P.



- ★ Really outstanding quality.
  - ★ Four Valve Battery Superhet.
  - ★ Long and Medium Wave-lengths.
  - ★ Perfect Reception in All Areas.
  - ★ Refined Cabinet 10 $\frac{1}{2}$ in. x 8 $\frac{1}{2}$ in. x 5 $\frac{1}{2}$ in.
  - ★ Very Simple Construction.
- Send 1/6 for "Superex 55" Construction Booklet.

Shop open 9 a.m. to 6 p.m. Monday to Saturday. 1 p.m. Thursday. Personal Shoppers Welcome.

**Tel.: ELGar 3644.**

## VALVES

2/6 — SP61 — 2/6

BRAND NEW

EF37A	11/-	PX25	9/-
EF50	4/-	EF54	5/-
EF36	3/6	EF39	7/6
EF91	7/-	EL91	5/-
EC52	5/-	EC54	4/-
6J5	5/-	6V6	8/6
EB34	2/-	SP41	2/6
EA50	2/-	SZ4	9/-
5U4G	9/-	VU39	8/6
1R5	7/6	1T4	7/-
1S5	7/6	1A3	6/-
1L4	7/6	3A4	5/-
6K7	6/-	6K8	11/-
6Q7	8/6	6X5	7/6
2X2	2/6	RK34	2/-
6SK7	4/-	6SH7	6/-
6SL7	6/-	6SN7	8/6
Pen 220	4/-	HL2	6/-
6SA7	9/-	6J7	7/-
105/30	6/-	150/30	7/6
CV286	7/-	CV287	7/6

# VINERS

(MIDDLESBROUGH)

26, EAST STREET, MIDDLESBROUGH

(Tel.: Mid 3418)

W/SET 88 F.M.—Trans-receiver. 14. 1.5 v. Filament Valves. 38-43 Mc/s. Crystal control, 4 crystals. 5 I.F., 3 Mc/s. Miniature. Less valves, bargain, 27/6 each.

BENDIX TX.—TA, 12G. Brand New. Covers 300 kc/s-600 kc/s. 3 Mc/s-4.8 Mc/s. 4 Mc/s-6.4 Mc/s. 6 Mc/s-9 Mc/s in 4 Channels. Valves: three 807, four 12SK7. £6 (mainland).

T1403 TX.—(Few left.) Brand New. TX Cabinet worth £6. Bargain at £3/10/-. Less valves (mainland).

TR9 RX.—Battery Set. 6 valves. 2 volt L.T. 120 v. H.T. 31-80 metres. Complete with valves, 15/- each.

SILICON or GERMANIUM DIODES at 2/- each.

Please add postage

CONDENSERS.—100 Mixed, 18/-.

RESISTORS.—100 Mixed, 12/6. Carbon,  $\frac{1}{2}$ - $\frac{3}{4}$  watt, 4/6 doz. 1 Watt, 5/6 dozen.

POTENTIOMETER.—All values to 2 meg., 2/6 each. 1 dozen our selection £1.

METERS.—8 for £1. Our selection. 300 mA. 500 mA, 2 $\frac{1}{2}$ in., 5/6 each. 30 mA 50 mA, 100 mA. M.C., 5/- each. .5 amp or 6 amp., T.C., 6/- each. 500 micro amp, 2 $\frac{1}{2}$ in., 12/6. M.I., 20 volt A.C., 8/6. Electrostatic 1,500 volt, 11/- .40 amp. A.C., with current transformer, 30/- each. 1 mA meter 2 $\frac{1}{2}$ in., 15/- each.

R.F. UNITS.—Brand New. 24 and 25. Less valves, 7/- .27 unit, £1.

TRANSFORMERS.—350-350 volt, 150 mA, 5 volt 6.3 volt, 35/- each. 350-350, 200 mA, 5 volt, 6.3 volt, £2 each.

# Turn SPARE time to CASH!

## PROFESSIONAL 3 VALVE MAINS SET IN SUPERB CABINET FOR ONLY . . .

A straight T.R.F. A.C. or A.C./D.C. Mains Set—requires no radio knowledge to assemble. Easy to read Diagram takes you step by step. Only tools needed are pliers, Screwdriver and Soldering Iron. ALL parts in stock NOW. Order AT ONCE stating which type of set is required A.C. or A.C./D.C. Mains—these are the sets to SHOW to FRIENDS!

Wiring Diagram and Parts List, 1/-, Post FREE

# 97/6

PLUS 2/6 FOR Postage & Packing.

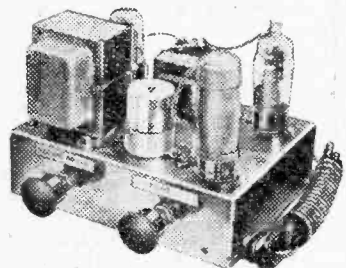
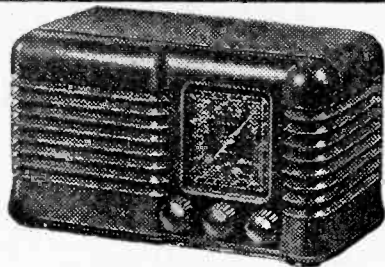

# 63/- ONLY

PLUS 2/- FOR Postage & Packing.

EASY TO READ WIRING CHART AND PARTS LIST 6d. (Post Free.)

## FOR THIS MULTI-PURPOSE AMPLIFIER UNIT KIT!

The CHEAPEST 3-Valve Amplifier on the market—can be built in 2-3 hours WITHOUT previous radio experience! High Gain, Negative Feedback and Ready-drilled Chassis which is not "live." Ideal for amplifying Grams, small P.A. Equipment, Baby Alarms, Office Intercom Sets, etc. An ABSOLUTE BARGAIN at this price—get YOUR order in NOW to avoid disappointment!

## SATISFACTION OR CASH REFUNDED!

WRITE NOW TO B'HAM'S LARGEST WALK-AROUND RADIO STORES!

# NORMAN H. FIELD

MAIL ORDERS: 97, STRATFORD RD., BIRMINGHAM, 11.

CALLERS: 68, HURST STREET, BIRMINGHAM, 5. Mid 3619

Rylee

## Great Britain's Valve Mail-Order House

AC6/Pen 8/8	KT32 10/6	SP61 2/-	VR91/ EF50 9/6
ACSP3 11/6	KL35 11/-	S130/ CV45 6/6	VR91 (Sollid)
ATP4 5/6	KT72 10/-	TH2321 10/6	VR125/ 5/9
ARP4 5/6	KT74 10/-	TP22 10/6	MSPenB 10/6
ARP5 8/-	KTW62 8/6	U21 12/-	VR135 5/6
ARP12 7/-	KTW73 10/3	U22 11/6	VR137 6/6
D41 8/6	KTW74 10/3	U71 10/-	VR150 11/6
D83 8/-	KTW75 10/3	U74 10/-	VR52/ EL32 9/6
DD41 9/6	KTZ41 10/3	UF1 10/-	VU39 10/6
DH73 10/-	KTZ63 8/6	UU7 10/-	VU111/ VU197 5/-
DL2 9/6	L13 10/6	VP13C 7/-	VU120A 10/6
DL63 10/-	L55A 10/-	VP23 3/-	W17 10/6
DL74 10/-	L55B 10/-	VP41 10/6	W76 10/3
DDT4 11/6	MSPen 5/-	VP133 10/6	W77 10/6
DDT13 11/6	N14 8/6	SG215 8/6	W81M 9/-
ECC31 12/6	NR45 12/-	VR19 7/6	XH(1.5) 6/-
ECC34 3/-	P2 3/-	FM2 7/6	XP(1.5) 6/-
ECL80 12/6	P215 2/-	QR21 8/6	X22 10/6
EC31 12/-	PD220 12/-	VR37 9/6	X61 10/6
EP22 9/6	PM12M 5/-	VR53 9/6	X63 10/6
EL2 11/6	Pen25 9/6	EP23 3/-	X71M 9/-
EL32 9/6	Pen46 10/6	VR54 5/6	X73 11/6
EL35 11/-	Pen229 9/6	EB34 5/6	Y63 8/-
EL50 7/-	Pen1340 10/6	VR55/ EB33 7/6	OZ4 6/-
H63 3/-	Pen DD 10/6	VR56/ EF36N 7/6	O1A 3/-
HL4 10/-	2530 10/6	EF36N 7/6	IH6 3/-
HL13 9/6	PenDD 10/6	VR56/ EF32 9/6	IL5 5/-
HL23 7/6	1360 11/-	VR57/ VR55A 9/6	1LN5 6/6
HL41 8/-	PX230 6/-	VR57/ SP41 4/9	2A3 10/6
HL41DD 10/6	QP22B 10/6	VR58/ SP4 5/9	2A6 2/-
HL133DD 8/6	R3 10/6	VR68/ P11 5/9	2A7 3/-
HL1320 9/6	SP2 5/6	VR78/ D1 4/6	5T4 12/1
HLDD1320 11/-	SP4 5/-	VR78/ D1 4/6	

**SALE**  
2000 **BRITISH AMERICAN BATTERY A.C. and UNIVERSAL TYPES**  
All fully guaranteed  
**FROM 2/-**

DEMOBBED VALVES MANUAL 2/6

RADIO **BULLS VALVES**  
246 HIGH ST. HARLESDEN, MIDDLESEX

Giving equivalents of British and American Service and Cross Reference of Commercial Types with an Appendix of B.V.A. Equivalents and Comprehensive Price List. We have still some Valves left at very old Budget Rates (33 1/3%) which are actually sold at the old price. (1951 rate.)

**R.T.H. GERMANIUM CRYSTAL DIODE.** Complete with Blueprint and operating instructions, 2/- Post free.

**PIFCO**  
All-in-one Radio-meter A.C./D.C. Tests everything in Radio. Complete with Test prods. Still 29/6. New price 32/6. Post 1/6.

**Q-MAX Chassis Cutters with Keys**  
The easiest and quickest way of cutting holes in sheet metal. The cutter consists of three parts: A die, a punch and an Allen screw. The operation is quite simple. Price incl. key: 1in., 12/4; 1 1/2 in., 12/4; 1 3/4 in., 13/4; 1 7/8 in., 14/6; 1 3/2 in., 15/6; 1 5/8 in., 16/6; 1 3/4 in., 17/6; 1 7/8 in., 18/6; 1 3/2 in., 19/6; 2 in., 20/6; 2 1/8 in., 21/6; 2 1/4 in., 22/6; 2 3/8 in., 23/6; 2 1/2 in., 24/6; 2 7/8 in., 25/6; 3 in., 26/6; 3 1/8 in., 27/6; 3 1/4 in., 28/6; 3 3/8 in., 29/6; 3 1/2 in., 30/6; 3 7/8 in., 31/6; 4 in., 32/6.

**The new revolutionary A/C ELECTRO-SAW**  
7,200 Cutting Strokes per minute. Cuts Wood, Plastic, Hardboard, Metal with amazing ease.  
56/- Cash or C.O.D. or 10/- deposit 5 mthly. of 10/6.

**You Plug in - IT SAWS!**

**5 Blade 9 1/2" SAW KIT**  
Wood Saw, Pruning Saw, Tenon Saw, Key Hole & Metal Saw. Spring steel tempered and hardened. "Unrepeatable."

**9" TUBE CRT 516 Magnetic 4 v. heater 4 to 5 kv. E.H.T. Int. Octal Base. BARGAIN Carr. and Crate, 4/6. 29/6**

**SERVICE SHEETS**  
The one you require enclosed if available in a dozen assorted of our best choice. 10/8.

Continued here w. U.S.A. Types next month !!! Post 9d.

# A Single-ended **DC** Amplifier

A HIGH-QUALITY UNIT SUITABLE FOR RADIO OR RECORDS

By "Constructor"

**T**HIS circuit, which was developed in the laboratories of Kendall & Mousley, Limited, aims at giving Hi-Fi at low cost. A complete kit of parts can be obtained for £9, with only the best components. If, however, the constructor cares to obtain the valves or components on the surplus market the price can be reduced. There is, however, one component that *must* be that specified, apart from the valves, and that is the output transformer.

The circuit is a directly coupled one, and this means that balance at all points of the circuit is of the greatest importance. The average resistor is of 20 per cent. tolerance, with the result that one of 1,000 ohms can be between 800 and 1,200 ohms; but if one of 10 per cent. is used, then the actual value will be between 900 and 1,100 ohms. The make of resistor chosen for the prototype was the Dubilier, as these are made in 10 per cent. at the same price as their old 20 per cent., which have now been discontinued. The theory of the circuit is that the anode voltage of the EF91 is about 50 volts positive to the chassis and that if a suitable cathode resistance is used with the EL41, then the cathode of this latter valve will, if its grid is joined to the anode of the EF91, run with the cathode just the correct amount positive to the grid. This at first seems quite simple to obtain, however, as if the mains voltage varies, so will the conditions of the H.T., and those within the valve. Thus the anode voltage of the EF91 will tend to fluctuate. This is overcome by the expedient of joining the screen of the EF91 to the cathode of the EL41. Thus, as the current through the anode circuit of the valve is dependent on the screen voltage, and the cathode current of the EL41 dependent on its grid voltage, we have the following compensating conditions: a rise in H.T. voltage will increase the current through EL41, with the result that the cathode voltage rises, and applies a higher voltage to the screen of the EF91, causing the anode current of this latter valve to rise. This rise increases the voltage drop across the 680 K in the anode circuit and drops the voltage of the grid of the EL41, thus setting its cathode current back to the correct value.

The use of such a high anode load for the EF91 has two advantages—to give a very high gain, and to ensure that the anode voltage is fairly low (about 50 volts). The electrolytic used for the cathode circuit of

the EL41 is running at its top limit, but this is in order, as the manufacturers state that it will take up to 60 volts. The very high gain of the circuit is not required for most record players using a crystal p.u., and so a very heavy amount of negative feedback has been applied. This improves both the linearity of the circuit and gives a good reproduction of transients by the reflected impedance of the output stage providing good damping to the speaker. That is, losses are compensated for and resonance effects of the speaker are reduced to a minimum.

The use of direct coupling has the effect of reducing both the constructional costs and the phase shift of the amplifier. In its turn the reduction of the phase shift, besides giving a better reproduction of the sound, allows the use of heavier negative feedback than would otherwise be possible.

Good tone controls are, of course, essential, and this one is a modified version of that used on the Mullard 5/10 amplifier. Slight changes in component values have been made to make it cover a slightly higher range of control.

## The Circuit

The basic amplifier circuit is given in Fig. 1, from which it will be seen that the tapping point of the heater winding is taken to the cathode of the output valve and not to earth. This has the effect of

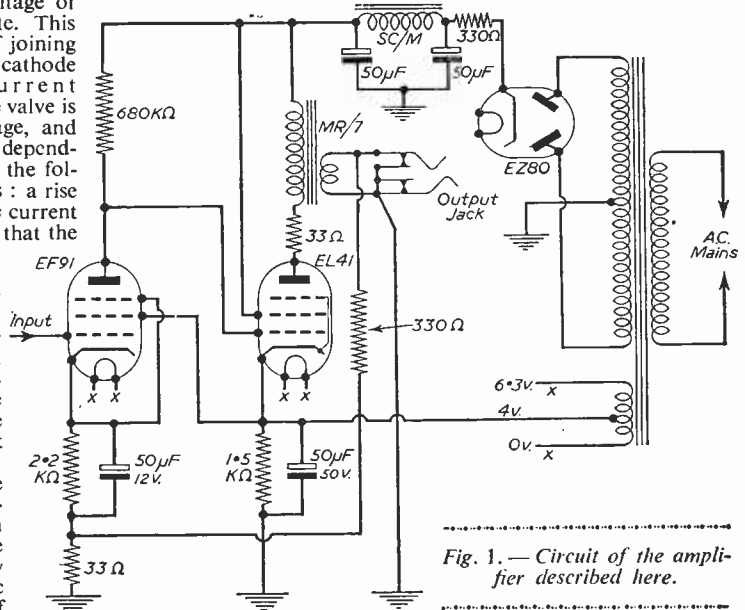

Fig. 1.—Circuit of the amplifier described here.

reducing the hum level of the amplifier by about 20 db., thus making it so low that with the input short-circuited one does not notice that the amplifier is switched on. The jacks chosen both for the input and output circuits are of the short-circuiting type—the J6 of Bulgin being the ideal job.

To simplify the construction of the amplifier a ready punched chassis has been made by Kendall & Mousley, Limited, which is readily available either direct or via your local dealer. A colour coding

chassis, roughly as shown in Fig. 2. The output transformer goes at left rear, with the lettered winding at the front and the numbered one at the rear. The SC/M smoothing choke in the centre with its tags to the left, the SR/250 mains transformer at the right-hand side with the mains connections to the rear. Jacks and valve holders can follow, care being taken with the latter to see that they are mounted as shown in Fig. 3, that is, the B8A for the EL41 with the "Blob" between pins 1 and 8

on the right-hand side of the chassis, and the space between pins on the other two holders pointing in the same direction. The three variable controls should be mounted as shown in Fig. 4. The positions of the tag strips and electrolytics are shown in Fig. 3.

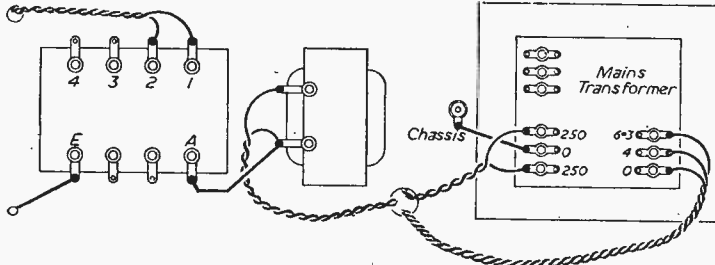

Fig. 2. — Layout of output transformer, mains transformer and smoothing choke.

**Wiring**

Having mounted all the components we can proceed with the wiring. Taking the heaters first, the black-black-red is joined to the bottom right-hand side

- of the wires has been used also and is as follows :—
- Black-Black-Red and Black-Black for heaters.
- Red-Red for the lead from transformers to rectifier.
- Red-Green : choke to electrolytics.
- Green-Brown : jack to secondary of O.P. transformer.
- Red : choke to O.P. transformer.
- Green : O.P. valve to pri. of O.P. transformer.
- Black : audio leads.
- Brown : earth leads.
- Three core flex for connection to the mains.
- These wires are all available with the complete kit or separately.

of the mains transformer. The tags are marked 0-4-6.3 ; join the black one to the 0 and the other to the 6.3, the red-red being taken to the 4. The other end of the lead is taken to the EL41 holder and the two blacks taken one to each of pins 1 and 8, the red wire being taken to pin 7 ; do not solder yet. Take the twin black lead and join one end to the two blacks on the mains transformer and solder. Take the other end to pins 4 and 5 of the extreme right holder on the chassis and solder. With the remainder of the twin black, make off the pins 1 and 8 of the B8A holder and solder. Take the other end after cutting to a convenient length to pins 3 and 4 of the central holder and solder. For stripping the ends of the plastic wires one can do no better than use the Bib strippers

**Construction**

Having obtained the components, the first step in the construction is to bolt the ironwork on the

(Continued on page 705)

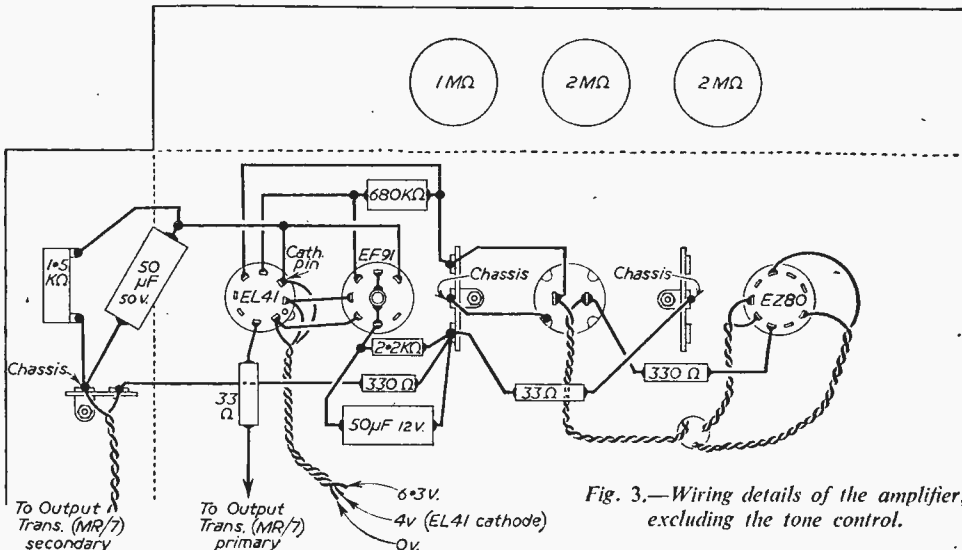
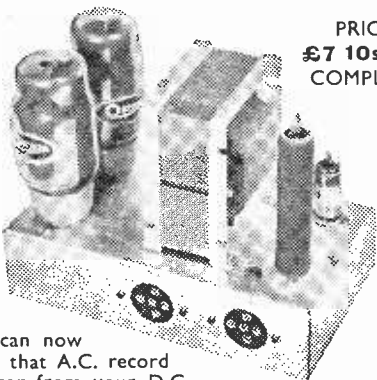

Fig. 3. — Wiring details of the amplifier, excluding the tone control.



## DC to AC CONVERTER



PRICE  
**£7 10s. Od.**  
COMPLETE

You can now drive that A.C. record changer from your D.C. Mains using this effective 50-cycle electronic converter.

- Input 200/250 D.C. ● Output 200/250 v. A.C.
- 25/30 watts ● Variable frequency and output controls ● Valves: Osram 277 and two KT55s
- In Push Pull ● Frequency stable with Mains
- Variations 190 v. to 250 v. ● Easily fitted
- Full instructions.

Write for full particulars to Dept. 2A:

**W.&L. COMPONENTS LTD.**

8, Camden High St. ● London, N.W.1. ● Tel. EUS 7844  
(near Mornington Crescent Underground)

## F.M. IS HERE

Many of our Tuners for the B.B.C. V.H.F. programmes are in use up to 80 miles from Wrotham. All parts available to build the Tuner featured recently in the *Radio Constructor*. This Tuner is often known as the Jason Circuit because the booklet was written by G. Blundell of Jason Motor & Electronic Co.

*Details of fringe area version also given.*

Booklet complete with photos and point-to-point diagram	£	s.	d.
	2	0	
Chassis, fully punched		8	0
Coil Set...	1	2	6
G.E.X.34 Crystal		4	0
Jason Dial		14	6
Jason V101 25 pF + 25 pF ...	10	9	

Jason Dial calibrated in Mc/s complete with bulbholders, already attached to Jason condenser and fitted to chassis

All parts with Jason Dial less valves. Complete with nuts, screws, solder, tags...

### THE JASON MOTOR & ELECTRONIC CO.,

328 (rear), Cricklewood Lane, London, N.W.2  
Tel.: SPE 7050 Demonstrations given.  
Evening Demonstrations by Appointment

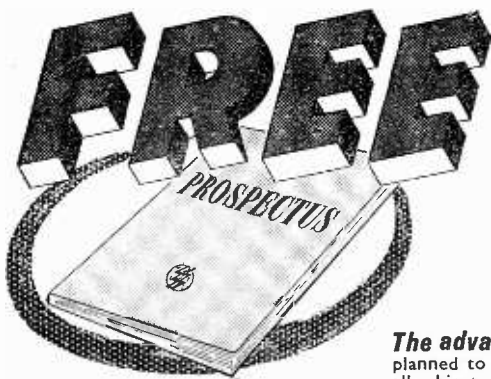

**POST THE COUPON TODAY FOR OUR BROCHURE ON THE LATEST METHODS OF HOME TRAINING FOR OVER 150 CAREERS & HOBBIES**

#### PRIVATE AND INDIVIDUAL TUITION IN YOUR OWN HOME

City and Guilds Grouped Certificates in Telecommunications: A.M. Brit. I.R.E. Examination, Radio Amateur's Licence, Radio and Television Servicing Certificates, General Radio and Television Courses, Radar, Sound Recording, etc. Also Courses in all other branches of Engineering and Commerce.

**The advantages of E.M.I. training** ★ The teaching methods are planned to meet modern industrial requirements. ★ We offer training in all subjects which provide lucrative jobs or interesting hobbies. ★ A tutor is personally allotted by name to ensure private and individual tuition. ★ Free advice covering all aspects of training is given to students before and after enrolling with us.

#### NEW LEARN THE PRACTICAL WAY

With many of our courses we supply actual equipment. Courses include: Radio, Television, Electronics, Draughtsmanship, Carpentry, Photography, and Commercial Art, etc.

**Courses from  
15/- per month**

#### POST THIS COUPON TODAY

Send without obligation your FREE book.  
E.M.I. INSTITUTES, Dept. 32K  
43 Grove Park Road, London, W.4.  
Phone: Chiswick 4417/8.

NAME .....

ADDRESS .....

NOV. ....

SUBJECT(S) OF INTEREST .....

# EMI INSTITUTES

The only Postal College which is part of a world-wide Industrial Organisation



Get your new

# BRIMAR MANUAL

The  
LATEST EDITION  
has  
**272 Pages**  
of **VALVE and**  
**TELETUBE DATA**  
**CIRCUITRY**  
**& SPECIAL**  
**COMPONENTS**

still only **5/-**

## SUMMARY OF CONTENTS

- Valve ratings and base connection symbols.
- Classified lists of nearly 300 valves, teletubes and selenium rectifiers.
- Germanium diode section including ratings in various circuits.
- Brimistors section.
- Radio engineering formulae and NEW circuits.
- Brimarize section. Valves and teletubes.
- Up-to-date substitution list of American types.
- Equivalents and C.V. numbers.
- Details of Trustworthy types.
- Valuable information on Transistors.

Send 5/- for your copy to: Publicity Dept.

Standard Telephones and Cables Limited FOOTSCRAY SIDCUP KENT Footscray 3333

### RADIO CONTROL

All parts including valve, waxolin panel, coil formers, etc., etc., to build regenerative receiver, given in September *Practical Mechanics*, price 14/6, plus 2/- post.

### A WONDERFUL CHRISTMAS PRESENT

Non-Mains absolutely safe

Children of all ages enjoy playing records and will be overjoyed to own the fine portable illustrated alongside. This uses the Garrard spring motor and a 2-valve battery amplifier. The case is in two-tone imitation crocodile/lizard skin. Special price £7.19.6, carriage 7/6 extra.



**SIX TORCHES 5/-**  
Parcel containing 2 hand lamps and four assorted tubular torches. Only 5/- Post 1/6.

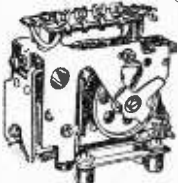

### REMOTE CONTROL

With only one pair of wires and a simple push button you can select any one of four stations without leaving your armchair. This is just one of the many applications of our impulse relay. There are many other purposes to which it can be put. Note they are somewhat soiled due to storage, but mechanically O.K. Price 2/6, Plus 9d. post, booklet free with relay or sep. 1/6.

### CLEVELAND CAR BATTERY CHARGER



gives 1 1/2 amps. charge — uses everlasting metal rectifier and robust double-wound mains transformer—in metal carrying case with leads and croc. clips.

Price 6 volts 29/6 ; 6 to 12 volts 39/6. Post 2/6.



4ft. long made from heavy gauge sheet steel (galvanised), 1 kW, suitable A.C. or D.C. Price £2.10.0 and 5/- carr., or with thermostat £3.15.0. Note: The thermostat mounts separately and will control up to three heaters.



### POWER UNIT FOR MODELS

Power unit designed for trains, etc. Gives 6 to 12v. D.C. continuously. Variable. Fitted reversing and mains on/off switch. Complete kit 35/-, carr. 2/6.

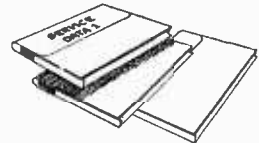

### SERVICE DATA

100 service sheets, covering British receivers which have been sold in big quantities, and which every service engineer is ultimately bound to meet. The following makers are included: Aerodyne, Alba, Bush, Cossor, Ekco, Eveready, Ferguson, Ferranti, G.E.C., H.M.V., Kolster Brandes, Lissen, McMichael, Marconi, Mullard, Murphy, Philco, Philips, Pye, Ultra. Undoubtedly a mine of information invaluable to all who earn their living from radio servicing. Price £1 for the complete folder.

Our folder No. 2 consists of 100 data sheets covering most of the popular American T.R.F. and superhet receivers "all dry," etc., which have been imported into this country. Names include Sparton, Emerson, Admiral, Crossley, R.C.A. Victor, etc. Each sheet gives circuit diagrams and component values, alignment procedure, etc., etc. Price for the folder of 100 sheets is £1. Post free.

### CRYSTAL SET



Two wave-band bakelite case, Germanium crystal — gets "Home" and "Light" anywhere without batteries. 18/-, Headphones, 15/6 pair.

## ELECTRONIC PRECISION EQUIPMENT, LTD.

Post orders should be addressed to Dept. 7, 123, Terminus Road, Eastbourne.

42-43, Windmill Hill, Ruislip, Middx. | 152-3, Fleet Street, E.C.4. | 89, Stroud Green Road, Finsbury Park, N.4. | 249, High Rd., Kilburn. Phone: MAIda Vate

(Continued from page 702)

and cutters. The heaters of the valves are wired and the next step is to wire in the H.T. This is done by taking the red-red wire and making off to the two tags marked 250 on the bottom left-hand side of the mains transformer and soldering. The other ends are taken to pins 1 and 7 of the right-hand valveholder (B9A) and soldered. A 330 ohm 1 watt resistor is then joined between one side of the electrolytic and pin 3 of the same valveholder. The red-green wire is now taken and made off to the electrolytic, the green of the pair being taken to the same tag as the 330 ohm resistor and soldered. The red is taken to the other tag and left unsoldered. The other end of the twin is taken to the smoothing choke, green to the rear and red to the front. A single red is then joined to the front choke tag and then across to tag "A" of the output transformer and soldered. Both choke tags can be soldered. Back on the underside at the smoothing electrolytics take a red lead from the red wire to one tag of the tag strip as shown in Fig. 3. A lead is then taken to pin 5 of the B8A holder and soldered. Join a 680 K. resistor between the H.T. tag of the tag strip and pin 5 of the centre valveholder, then take a wire from this tag to tag 6 of the B8A holder and solder. Solder a lead from the centre tag of the tag strip to one of the four fixing ears of the electrolytic. Join a wire between the 0 tag of the H.T. winding of the mains transformer to a fixing screw head, solder takes quite easily on a brass screw.

The output jack makes quite a useful earthing tag for the 1.5 K. bias resistor for the EL41. A lead should be made off to tag nearest to the side of the chassis but not soldered. A lead will have to be soldered to the 1.5 K. 10 watt resistor, the negative end

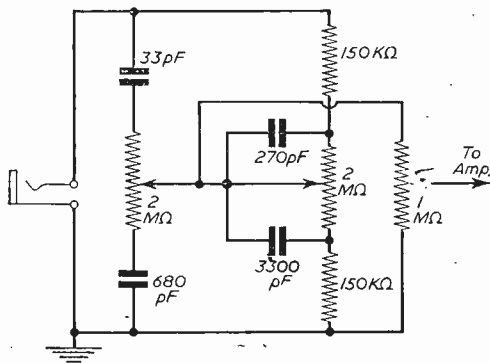

Fig. 5.—Theoretical circuit of the tone control.

of the 50 μF 50 volt electrolytic made off, but not soldered, to the same tag, and the 330 ohm ½ watt joined between the other tag of the jack and the other end of the tag strip and left unsoldered. Finish at the jack by joining on the green-brown twin, one

to each tag and then solder. Take the other side of the bias resistor and that of the bias condenser to pin 7 of the B8A holder and solder. Take one of the two 33 ohm resistors and cut the leads down to ½ in. and solder one end to pin 2 of the B8A holder and the other end to one end of the green wire, and take

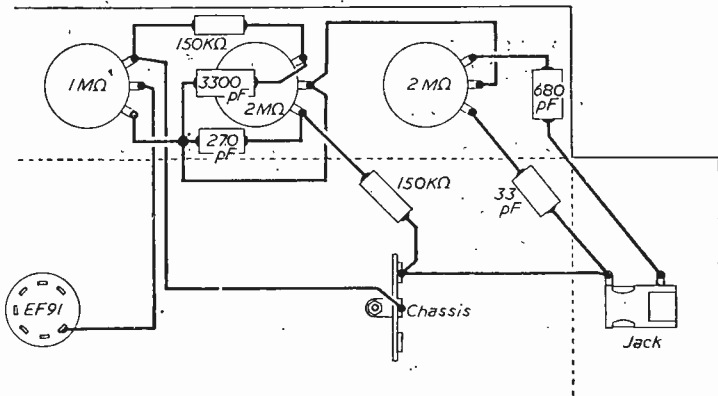

Fig. 4.—Wiring details of the tone control.

the other end of this wire to tag "E" of the output transformer and solder. Take the spare end of the green-brown and make off to tags 1 and 2 of the output transformer, but do not solder.

**Completing the Wiring**

We now have the rectifier, output valve, mains and

**LIST OF COMPONENTS**

- One EF91 Mullard
- One EL41 "
- One EZ80 "
- One B9A valveholder (McMurdo)
- One B8A " ( " )
- One B7A " ( " )
- One 50 μF 12 volt electrolytic (Dubilier)
- One 50 μF 50 " ( " )
- One 50-50-35 C.T.E. " ( " )
- One 680 pF moulded mica " ( " )
- One 33 pF " " ( " )
- One 270 pF " " ( " )
- One 3,300 pF " " ( " )
- One 1 M potentiometer (less switch) (Dubilier)
- Two 2 M " " ( " )
- Two 150 K ½ w. " 10% resistors (Dubilier)
- Two 33 ohm ½ w. " " ( " )
- One 680 K ½ w. " " ( " )
- One 2.2 K ½ w. " " ( " )
- One 330 ohm ½ w. " " ( " )
- One 330 ohm 1 w. " " ( " )
- One 1.5 K 10 w. " " ( " )
- One SC/M choke (Elstone)
- One MR/7 output transformer (Elstone)
- One SR/250 mains transformer (Elstone)
- One chassis, 10in. x 6in. x 2½in. (Kendall & Mousley, Ltd.)
- One type "9-12" instrument case (optional)
- Three Bulgin K107 knobs
- Two " J6 jacks
- Two " P38 plugs
- Two three-way tag strips (Kendall & Mousley, Ltd.)
- One set of coloured lead wires (Kendall & Mousley, Ltd.)
- Nuts, bolts and washers (Kendall & Mousley, Ltd.)

output transformers wired along with the electrolytics and smoothing choke. Join pins 2 and 6 of the centre valveholder and join via a 2.2 K. resistor to the same tag as the 330 ohm  $\frac{1}{2}$  watt. Join the 50  $\mu$ F 12 volt electrolytic across the 2.2 K. resistor and another resistor of 33 ohms between the tag and centre tag of the second tag strip and solder these wires.

There only remains now the wiring of the input jack and the volume and tone controls. Join pin 1 on the centre valve to the rider of the left-hand control, i.e., when viewed as in Fig. 4. Solder. Join the centre tag of the right-hand tag strip to the top tag of the I M. potentiometer and join to the top tag of the centre control via a 150 K.  $\frac{1}{2}$  watt resistor. Join the top tag of the centre control to the bottom tag of the I M. via a 3,300 pF condenser, and the bottom tag of the centre control to the same tag of the I M. control with a 270 pF condenser. Join the centre tag of the centre control direct to the centre tag of the right-hand control, and the bottom tag of the I M. control. Join a 150 K. resistor between a spare tag on the solder tag strip and the bottom tag of the centre control. Join the solder tag to the live side of the input jack. Now join a 33 pF between the live tag of the input jack and the bottom tag of the right-hand control. Join a 680 pF condenser between the earth side of the

jack and the top tag of the right-hand control. The wiring should be as shown in Fig. 4.

The theoretical circuit of the tone control is shown in Fig. 5 and it should be quite a simple job for the experienced constructor to make a treble check on the wiring. First with the point to point wiring instructions, then the point to point diagrams in Figs. 2, 3 and 4, then finally with the theoreticals in Figs. 1 and 5.

### Testing

The mains lead can be soldered on and all joints soldered with the exception of the two on the secondary side of the output transformer. The speaker can now be plugged in and the amplifier switched on; it should just give a slight rustle in the speaker, but if it howls one has only to reverse the leads to the secondary side of the output transformer. The leads to the secondary side of the output transformer can now be soldered.

The choice of speaker is important.

Input equipment is also of great importance, as a chain is as strong as its weakest link. Garrard turntables with a suitable plug-in head such as the Acos High "G" types give an exceptional result. Again, hum can often be introduced by incorrect connection. Co-axial cable seems to be an obvious choice, but it introduces hum.

## MEASUREMENT OF LOW RESISTANCE WITH A SENSITIVE METER

By J. A. Taylor

**A**FTER fitting a standard replacement I.F. transformer I noticed that it had four solder tags on the base as well as the pigtail lead on the top.

My test meter is home-made from an ex-R.A.F. meter movement of 500  $\mu$ A full scale deflection. With a 1.5-volt cell in circuit this gives a centre-scale indication of 3,000  $\Omega$ , so although excellent for most purposes it is useless for measuring very low resistance. I had to adopt an old dodge to solve my little problem.

I attached two leads to the meter movement terminals, shorted the normal meter leads and was then able to shunt the meter with the I.F. connections.

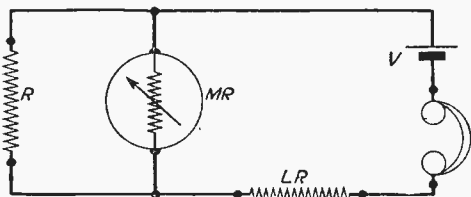

The set-up for measuring low resistance.

A dead short across the meter caused the meter to return to zero and the low resistance of the I.F. secondary winding gave a meter indication of about 30 micro amp.

It is a simple matter to calibrate the dial for this extra duty and I think it well worth the effort, the procedure is as follows:

The actual resistance of the meter with R as shunt is as follows:

$$\frac{R \times MR}{R + MR} = r$$

The voltage dropped across r is:  $\frac{r}{LR+r} \times \frac{V}{I} = P$

Now the current flowing through the meter is  $\frac{P}{MR} = A$

With my particular meter the values are as follows:

$$MR = 75 \Omega$$

$$LR = 2,925 \Omega$$

$$V = 1.5 \text{ volt.}$$

Let us calculate the meter indication for 10  $\Omega$

$$r = \frac{R \times MR}{R + MR} = \frac{10 \times 75}{10 + 75} = \frac{750}{85} = 9 \Omega$$

$$P = \frac{r}{LR+r} \times \frac{V}{I} = \frac{9 \times 1.5}{2925+9} = \frac{13.5}{2934} = .0046 \text{ volts}$$

$$A = \frac{.0046}{75} = .00006 \text{ amps.}$$

This is, of course, 60  $\mu$ A.

The other points work out as below:

Shunt resistance in ohms	1	5	10	20	30	40	50	60	70
Meter indication in micro amps	7	32	60	107	146	178	205	220	248

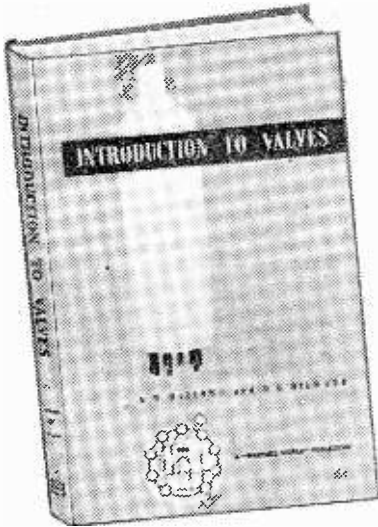

“... will appeal not only to the beginner but to the more advanced worker”

*The Technical Journal*

# Introduction to Valves

By R. W. Hallows, M.A.(CANTAB.), M.I.E.E., and H. K. Milward, B.Sc.(LOND.), A.M.I.E.E.

Describes the principles of operation of the radio valve and its uses in circuits of various types. Following an explanation of the fundamental thermionic valve, the book deals with diodes as rectifiers and detectors; triodes and their various applications; tetrodes and pentodes; multiple-grid valves for frequency-changing; power-output valves; and valves for v.h.f. and e.h.f. operation. Special-purpose types and the construction of modern miniature and sub-miniature valves are also covered.

Published for “Wireless World”

8½ in. x 5½ in. 152 pages

8s. 6d. net. By Post 8s. 10d.

Obtainable from booksellers or direct from:

ILIFFE & SONS LIMITED      DORSET HOUSE      STAMFORD STREET      LONDON S.E.1

**COMMUNICATIONS RECEIVER R.1155.** Another purchase from the Air Ministry enables us to once again offer this superlative Communications Receiver at prices to suit every pocket. A World Station Getter, this covers 5 wave ranges: 18.5-7.5 mc/s., 7.5-3.0 mc/s., 1,500-500 kc/s., 500-200 kc/s., 200-75 kc/s., and is easily and simply adapted for mains use, full details with circuits of receiver being supplied. New in Maker's Cases and aerial tested. **£11.19.5.** Ditto but slightly used for demonstration purpose. **£9.19.6.**

**A.C. MAINS POWER PACK OUTPUT STAGE.**—In black metal case enabling the receiver to be operated immediately without any modification, can be supplied as follows:—Less Speaker, **£4.10.0**, with 6in. P.M. Speaker, **£5.5.0**. DEDUCT 10/- IF PURCHASING RECEIVER & POWER PACK TOGETHER.

Please add carriage costs of 1/6 for Receiver and 3/6 for Power Pack.

**TRANSFORMERS.** Manufactured to our specification and fully guaranteed. Upright mounting, fully shrouded, normal primaries.  
 425 v.-0-425 v. 250 mA., 6.3 v. 4 a., 6.3 v. 4 a., 5 v. 3 a., 65/-.  
 350 v.-0-350 v. 160 mA., 6.3 v. 6 a., 6.3 v. 3 a., 5 v. 3 a., 47/6.  
 350 v.-0-350 v. 150 mA., 6.3 v. 5 a., 0-4-5 v. 3 a., 37/6. 250 v.-0-250 v. 100 mA., 6.3 v. 6 a., 5 v. 3 a., 37/6. 250 v.-0-520 v. 60 mA., 6.3 v. 3 a., 5 v. 2 a., 21/-.  
 Please add 2/- per transformer postage.

**SPECIAL OFFER. Ex-Admiralty L.T. TRANSFORMER.** Normal mains input, output 4 v. 20 amps. C.T. New and unused, these have become damaged, but are still usable, the damage being confined to broken fixing lugs, and/or broken bakelite terminal panels. Formerly sold at 30/-. now offered at 17/6 (post, etc., 2/6).

**AVOMINOR CARRYING CASES.** Size 5in. x 5in. x 2in. with long carrying strap. In high quality leather with press stud fixing flap. Made for UNIVERSAL Avominor. BRAND NEW. ONLY 7/6. (Postage, etc., 1/-.)

**WALKIE TALKIE TYPE 18.** Covers 6.0-9.0 Mc/s. Complete with valves, and transmitting and receiving units in metal case. In excellent condition. ONLY 79/6 (carriage, etc., 10/6.)

**MODEL MAKERS MOTOR.** Reversible poles. Only 2in. long and 1½in. diameter with ½in. long spindle. Will operate on 4, 6, 12 or 24 volts D.C. ONLY 10/6.

Amounts given for carriage refer to inland only.

**U.E.I. CORPORATION** 138, Gray's Inn Rd., London, W.C.1 (Phone: TERMINUS 7937)

Open until 1 p.m. Saturdays. We are 2 mins. from H/gh Holborn (Chancery Lane Station) and 5 mins. by bus from King's Cross.

## THE FAMOUS BENNETT COLLEGE can train your mind to SUCCESS

THROUGH PERSONAL POSTAL TUITION  
 A FREE book vital to your career!

Read how the famous Bennett College can help you to success! Send now for this recently published FREE book, "Train your mind to SUCCESS", which tells you about The Bennett College proven success in postal tuition... and how it can help you to success in your career.

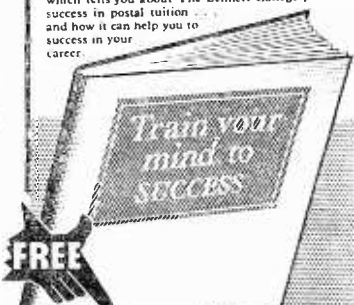

WHAT CAREER DO YOU WANT?

- Building
- Carpentry
- Commercial Art
- Diesel Engines
- Draftsmanship
- Electrical Eng.
- Fire Engineering
- Mechanical Eng.
- Quantity Surveying
- Radio Eng.
- Surveying
- Telecommunications
- Television

- Accountancy Exams
- Auctioneers' Exams
- Book-keeping
- Civil Service
- General Education
- Journalism
- Language
- Mathematics
- Police Subject
- Salamanca
- Secretarial Exams
- Shorthand
- Short Story Writing
- and many others
- GENERAL CERT. OF EDUCATION

FREE

To The Bennett College (Dept. K.104N), Sheffield  
 Please send me, without obligation, a free copy of 'Train your mind to SUCCESS' and the College Prospectus on:

SUBJECT \_\_\_\_\_  
 NAME \_\_\_\_\_  
 ADDRESS \_\_\_\_\_  
 AGE (if under 21) \_\_\_\_\_ Please write in Black Letters

**THIS COUPON**  
 COULD BE YOUR  
 PERSONAL PASSPORT  
 TO SUCCESS.  
 Send it NOW!

# ALFRED PADGETT

40, MEADOW LANE, LEEDS 11

13 Valve Receiver-Trans. Mark I. Z.C.T. Complete with 12 volt power pack and valves 6V6 (2), 6Q7 (1), 6X5 (2), 6K3 (1), 6U7 (7), 35-150 meters. Bargain Price £5/5/-, carriage 10/- Bench tested. 12/6 extra.

**TX1154.** Less valves, but complete with meters. Condition fair. 10/-. Carriage 10/-.

**T.U.B. UNITS TYPE 7, 8 and 9.** 10/- each. 7/- carr.

Radio Valves with a 90 days' guarantee. Post 9d. per valve. Doz. lots less 5% post free.

6V6GT	6/6	6SL7	6/6	CV6	1/-
6K7G	4/-	6J5	3/6	MS Pen	1/6
6K7M	5/-	6X5	5/6	7-pins	2/6
6H8G	7/6	2X2	2/6	VR137	1/3
6HG	1/3	VU111	1/6	12SH7M	2/6
6HGM	1/3	954	1/3	12SJ7M	2/6
6CG	3/6	955	2/6	12H6M	1/3
6SN7	6/6	9004	1/-	VR150/30	5/6

**BRAND NEW 3BP1 Tube**, complete with base and screening case. Just the job for a scope or bedside TV. 15/-, insurance and packing 4/-.

**Small 24 volt A.C./D.C. Motor.** 1,800 rev. P.M. Good torque on 12 volt, 3/6, post 1/9. **Mixed Radio Panels.** Hundreds sold in the past, 4/6 doz. Post free.

**New Metal Rectifiers.** Small in size, 12 months' guarantee, 250 volts at 100 Mills. 6/6, post 1/3.

**Toggle Switches.** Bakelite. 6d. Metal with lum. dolly C.H. 1/-, post 6d. Doz. lots post free.

**Miniature Pre-set Pots.** 1 Meg. 1 Meg. and 100 k. 9d. each, post 6d. Doz. lots post free.

**82A Tube Unit.** Complete with VR37 tube, but less valves, 19/6, carriage 10/-.

**Small Panel.** With 3.1 Meg. wire resistors. Plus or minus, 1% bobbin wound. If you are building a meter, it's a must. 3/6, post 9d.

**Handy Box of Mixed B.A. Nut and Bolts,** etc. Qtr. lb. weight, 1/-, post 9d.

# YOU can become a First Class RADIO ENGINEER

We can train you to earn good money in your spare-time, start a radio business of your own or qualify for well-paid employment. Our Home-Study Courses in Radio, Television and Mathematics are up-to-date, and easy to understand. The fees are very reasonable and can be paid by instalments.

## T/C RADIO COLLEGE

ESTABLISHED IN 1933

Send for free details, which will be sent in plain sealed package. Simply write your name and address inside the flap of an unsealed envelope (postage 1d.) or on a postcard (postage 2d.) and address it to the Principal :-

R. HEATH BRADLEY,

DUART HOUSE, ASHLEY ROAD, NEW MILTON, HANTS.

## THE VALVE SPECIALISTS

# Bentley Acoustic Corp. Ltd.

38, CHALCOT ROAD, N.W.1.

PR11mrose 9090

1st grade goods only. No seconds or rejects.

0Z1	6/-	6Z5	12/6	1B309	9/-	KT44	7/-
1A5	6/-	7A7	8/6	8B119	11/-	KTW61	7/-
1C5	11/-	7B7	7/6	8L633	7/6	KTW62	5/-
1D5	10/6	7C5	8/-	CK505	6/6	KTZ41	6/6
1D6	8/6	7C6	8/-	1K523	6/6	KTZ55	6/6
5E3	6/6	9D5	10/6	8K325	6/6	KN192	10/-
1G6	6/6	7D8	6/-	CV31	11/6	LP2	4/6
1H5	11/6	7H7	7/6	DT7	6/-	MH4	5/6
1L4	6/-	7Q7	8/-	DA90	8/6	M1	6/6
1LLD5	5/-	7R7	8/6	DA92	11/-	N78	11/6
1LLB5	5/6	7V7	8/6	DA97	7/-	N150	10/6
1N5	11/-	8D2	2/6	DC90	10/-	OC3	9/-
1R5	7/-	8D3	6/6	DF33	11/6	OD3	8/6
1T4	7/-	10C2	10/6	DF91	7/-	OM6	7/6
2C26	4/-	10D1	4/6	DF92	6/-	PC94	11/-
2D21	9/6	10F1	10/-	DF77	6/-	PN90	11/6
2X2	4/6	10J13	9/-	DK92	7/-	PCL3	12/6
3A1	7/6	10P13	10/-	DK96	8/6	Pen 25	6/6
3A5	10/-	12A6	6/6	DL2	15/-	Pen 46	7/6
3B7	8/6	12A8GT	10/135	11/-	Pen38	15/-	
3D6	2/6		15/-	DL72	7/-	PL81	10/6
3Q5	9/6	12AH7	12/6	DL149	10/-	PL90	9/6
4B4	7/-	12AH8	11/6	DL148	8/-	PL83	11/6
5V4	8/-	12AT7	8/-	EA50	8/-	PM12	4/6
5V4	10/-	12A17	9/-	EA76	9/6	PM12M	6/6
5Y3	7/6	12A X7	9/-	EA91	9/-	PM256	6/6
5Z4	6/6	12B85	6/6	EB34	7/-	PM255	7/6
6A5	10/6	12BH7	12/6	EB41	10/6	PY80	9/6
6A5	12/6	12E1	30/-	EB91	6/-	PY81	10/6
6AB8	10/-	12H6	3/-	EB93	12/6	PY82	7/6
6A7	6/6	12J5	6/-	EB94	7/6	PY83	10/6
6A15	6/6	12K8	8/6	EB91	10/6	Q221	7/6
6B7	12/6	12M7	7/6	EBF80	10/-	Q222	12/6
6AL5	6/-	12MGT	5/6	EBL31	17/6	QP25	6/6
6AM6	6/6	12S7	8/-	EC92	5/6	Q85/10	10/6
6AQ5	8/6	12SK7	6/-	EC34	6/6		10/6
6A7B	8/-	12SK8	8/6	EC91	7/-	QR150/13	10/6
6B	5/-	12A47	7/6	EC32	10/6		12/6
6B4G	7/6	13VPA	3/6	EC33	8/6	QV047	9/6
6BSG	4/-	14R7	10/6	EC35	8/6	8130	8/-
6BRM	4/6	19H1	10/-	EC31	9/-	8136	7/6
6BK6	6/6	20D1	8/-	PC382	10/6	SP47	8/6
6J46	8/6	20L1	10/-	EC393	7/6	SE41	8/6
6B7B	7/6	20P3	11/6	EC94	6/6	SP61	9/6
6BR7	10/-	20P4	11/6	EC93	17/6	TD12A	8/6
6BX6	10/6	25Z4	8/6	EC95	11/6	TE233	10/-
6C5	6/6	25Z5	8/6	EC42	10/-	TP22	8/6
6C8	8/-	30	7/6	EC81	10/-	TP40	35/-
6C16	6/6	30L1	10/-	EC80	10/6	U15	12/6
6D6	6/6	35L6	8/-	EC92	10/6	U17	7/6
6PG4	7/6	35Z4	8/6	EP26	4/6	U18	10/6
6P6M	8/-	35Z5	8/6	EP37A	10/6	U19	9/6
6P1	12/6	42	8/-	EP29	6/6	U25	12/-
6P8	7/-	43	8/6	EP41	9/-	U31	8/6
6P12	6/6	45Z5	12/6	EP42	12/6	U50	7/6
6P13	12/6	50C5	10/-	EP50(A)	8/-	U52	8/6
6P17	9/6	50L6	8/-	EP50(B)	5/-	U78	7/6
6P32	6/6	50Y6	8/6	EP54	5/-	U150	9/6
6P33	9/6	61BT	12/6	EP73	10/6	U153	10/6
6P6	6/6	61BT	15/-	EP80	10/6	U251	12/6
6HG6	2/6	62TR	10/-	EP85	10/-	U326	10/6
6H6M	3/6	72	6/6	EP86	12/6	UBC41	9/-
6J5G	5/-	76	7/-	EP91	6/6	UC42	9/6
6J5GT	5/6	77	8/-	EL3	15/-	UP41	8/6
6J6	6/6	78	8/6	EL32	6/6	UT41	9/6
6J7G	5/-	80	8/6	EL41	10/6	U9	9/6
6K6	7/-	83	8/6	EL84	11/6	UY41	9/-
6K7G	5/-	85A2	10/6	EL91	6/6	VL8492A	10/6
6K7M	6/-	210LF	3/-	EM34	10/-		23
6K6G	4/-	301	10/-	EM80	10/-	V96	6/6
6K5GT	8/6	307	7/6	EX95	12/6	VBP43	10/6
6L6	7/6	98	85/-	EX91	7/6	VZ2	10/6
6L13	10/-	813	70/-	EZ40	9/-	VP2(7)	8/6
6N7G	7/6	866A	15/-	EZ41	9/-	VP47	8/6
6N7M	8/-	885	10/6	EZ90	9/-	VP12K	8/6
6G17	8/6	956	3/6	GZ30	12/6	VP23	6/6
6G17G	9/-	1202	7/6	HS0	5/-	VP4	7/6
6SA7	8/-	1629	7/6	HL2	3/-	VP153	10/6
68C7	10/-	2101	10/6	HL13C	7/6	VR33	5/6
68G7	8/6	4022AR	5/-	HL23(D)		VT501	6/-
68H7	8/6	4033	12/6		6/6	W150	9/6
6J7	8/-	5763	6/6	HL41	7/6	X251	12/6
68K7	6/6	1938	2/6	HL41(D)		X150	10/6
68L7	8/-	9002	5/6	K35	9/6	Y63	7/6
68N7	8/6	9003	5/6	HL133(D)		XYF12	6/6
6U7	8/6	9006	7/6		12/6	XYF12	6/6
6V6G	7/-	ACT4	8/-	HYR2A	7/6	XFI(1.5)	4/-
6V6GT	7/6	ACTV(T)	7/6	HC92	8/6	XM41.5	4/-
6X4	7/6		10/6	K35	9/6	Y63	7/6
6X5	6/6	AP4	7/6	KK32	10/6	Y63	10/6
6V7	15/-	ATP4	3/-	K135	9/-	Z77	6/6
6Z48A	8/6	AZ31	10/6	K72	5/-	Z719	10/6

All boxed and guaranteed. Post 6d. each. Same day service. Shop hours 8.30 to 5.30, Sat. 1 p.m. Why not phone or wire that urgent order for immediate despatch C.O.D.? Complete list free S.A.E.

# BUILD THIS FOR 49/6



Build this exceptionally sensitive triode radio. Uses unique assembly system and can be built by anyone without any radio knowledge whatever in 45 minutes. Handsome black-crackle steel case with specially made black and gold dial with stations printed. Size of radio only 5 1/2 x 5 in. x 3 in. Covers all Medium and Long waves—uses one only aldry battery which costs 7s. 9d. and lasts many months, as H.T. consumption is only 1 to 1.5 ma. Ideal for Bedroom, Garden, Holidays, etc. Many unsolicited testimonials. Mr. Norton, of Oxted, writes: *Yesterday evening on the Medium waveband, I counted 32 separate stations: I am very pleased with the set, which is well worth the money. Cost of Complete Kit 49s. 6d. (including all plans, post, etc.). Or Parts sold separately. Note: We stock complete range of components and valves, orders despatched by return. Overseas orders welcomed—Regret no C.O.D. abroad.*

**CONCORD ELECTRONICS (P.W.)** (Dept.) (Prod. SIDNEY C. LONG)  
39, Queens Road, Brighton, 1

## GRAND CLEARANCE SALE!

(All goods guaranteed unused and perfect.)  
**5K, 100K, 500K Potentiometers.** All with good spindle, mostly original cartons. 6 for 5/6 (1/3 each). Assortment of 12 "Pot." (including the above), 10/-, Nicas, 2/- doz. 1, 50, 75, 200, 400, 600, 2,000, 3,000, 5,000 ft. (Midget 100 ft. 6d. each).  
**Double 0.1 mfd. or 0.5 mfd.** 400 v. small metal block. (Tan save space and neat) layout acting as tag strips. 5d.; 6 for 2/-.  
**Double 50 pf. Trimmers,** postage stamp type (two trimmers for price of one) 8d.  
**Midget Tubulars.** 0.04-0.01 mfd., 3/6 doz. 6 mfd. 2,000 v. Test. 2/9, post 1/-.

**SPECIAL VALVE OFFERS**  
P.W. "Economic Amplifier" Valves. Two RK33s, with holders, 5/6. (Use for push-pull output and/or full wave rectifiers.)  
**6V6G.** Still one of the best output valves; 5/-, now for 10/6.  
**6K7G.** New, in makers' cartons. 4/3 (3 for 11/9).  
**6K7.** As above, but metal. 5/9 each.  
**EC81, 8/9, EP92, 4/9, 12S7, 5/9.** Many other types at rock bottom prices.

**STOCK LISTS (LIST 3d.)**  
**COAX.** Low loss, 9d.; standard, 6d. yd.  
**SILVERED CERAMICS** (wire ended) 500 v. (Take up less room than resistors, and give a quality job) 4, 7, 7.5, 10, 15, 20, 22, 27, 33, 39, 47, 56, 75, 100, 150, 200, 270, 330, 390, 470, 1,000, 2,000, 3,000, 5,000 pf., 9d. 8/- doz.  
**WIRE WOUND RESISTORS, SILICONE COATED.** 25, 50, 68, 100, 150, 200, 250, 330, 500, 680, 1K, 1.5K, 2K, 2.5K, 3.5K, 5K, 6.8K, 10K; 5 w. 1/3; 10 w. 1/6; 15 w. 1/8. 15K, 18K, 20K, 25K, 33K; 5 w. 1/9; 10 w. 2/8.

**BOOKS OF THE FUTURE!**  
"Practical Transistors and Transistor Circuits." 3/6, post 3d. Build these new exciting circuits now using your own cheaply-made transistors. All you need to know in this absorbing book.  
"Practical F.M." 5/-, post 4d. (Music lovers should be building their F.M. sets now.) F.M. fully explained with lots of circuits for home construction.  
"Radio Controlled Wobblers for Amateurs." 5/-, post 4d. Just published! Gives simple explanations and practical data for all types of control systems.  
Post 6d. on all orders under 1d. except where stated.  
**READ & FORD** 2A, BURNLEY RD. AINSDALE SOUTHPORT.

# News from the Trade

## Pre-amplifier for High Fidelity.

**H. J. LEAK AND CO., LTD.**, have announced the new Leak Varislope Mark II pre-amplifier, designed to give the most flexible and accurate control over the quality of sound reproduction.

The most objectionable types of distortion occur at treble frequencies, and one of the features of the

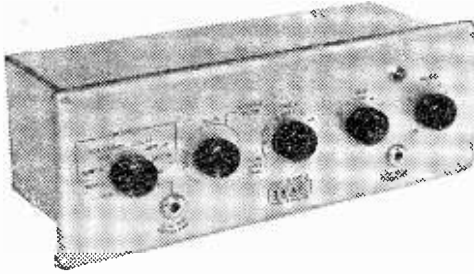

*The Varislope Mark II.*

Varislope Mark II is its accuracy in reducing such distortions. It is essentially a low noise, low distortion, two-stage feedback tone control pre-amplifier. The first stage gives record compensation by means of a frequency selective negative feedback. Negative feedback is also used in the "tuner," "tape" and "auxiliary" input circuits and is partially released in the "microphone" input circuit to give high gain and a flat frequency response.

In the second stage, negative feedback tone control circuits give bass and treble lift and a resistor capacitor circuit gives bass cut.—H. J. Leak and Co., Ltd., Brunel Road, London, W.3.

## Portable Record Reproducer

**THE** new "Babygram," produced by Portogram, Ltd., has a three-speed motor and plays all size records at all speeds. It incorporates a full size 7in. by 4in. elliptical loudspeaker, a crystal pick-up fitted with dual sapphire needles, and a two-valve



*The "Babygram" made by Portogram, Ltd.*

amplifier with tone, volume and on/off controls.

It is covered in I.C.I. leather cloth of various designs and colours. Weight, 8½lb. Dimensions, 12in. by 10½in. by 5½in. For use on 200-250 volts, A.C. mains. Price, 11 guineas; 110-volts model, 10s. 6d. extra.—Portogram Radio Electrical Industries, Ltd., "Priel Works," St. Rule Street, London, S.W.8.

## F.M./A.M. All-dry Receiver

**THE** Ever Ready Co. (Great Britain), Ltd., is first in the field with the only battery-operated radio receiver that incorporates F.M./A.M. This is their "Sky Monarch", push-pull model.

This nine-valve superheterodyne receiver has three wave bands: Long Wave Band, Medium Wave Band and F.M. Wave Band. Station names and wavelengths are clearly marked and calibrated. The

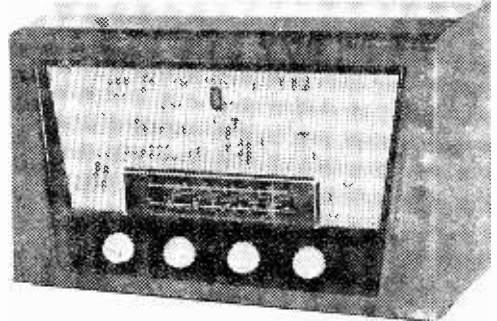

*The new Ever-Ready F.M./A.M. receiver.*

loudspeaker is fitted with 8½in. moving coil to ensure high fidelity. Extension loudspeaker sockets are also fitted. The aerial is self-contained for medium and long wave bands. There is an internal dipole for F.M. band with socket for external dipole. Weight, 31lb. 7oz. with battery. Dimensions, 20in. by 9½in. by 12½in. Total price to the public, including purchase tax and battery, is £30 13s. 8d.—The Ever Ready Company (Great Britain), Ltd., Hercules Place, Holloway, London, N.7.

## New Mullard Power Triode

**WE** learn from Mullard, Ltd., that the Mullard power triode TY4-350, which is a direct replacement for the U.S. type 833A, is now available.

The valve, which is widely used in R.F. heating equipment, has a maximum rated anode dissipation of 300 watts, and operates with H.T. voltages up to 3 kV. It has a thoriated tungsten filament which operates at 10 volts 10 amps.

A photograph of the TY4-350 is shown here.—Mullard, Ltd., Century House, Shaftesbury Avenue, London, W.C.2.



# Programme Pointers

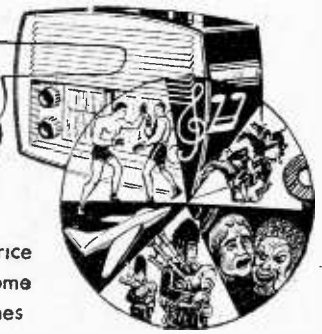

## New Musical Game

THE new quiz game honours music, and classical music at that, with its attentions. "Call the Tune," with pianist Joseph Cooper in the chair, is well under way and as pleasant to listen to as any of the others. The first time I heard it the panel was made up of Caryl Brahms, Michael Ayrton and Stephan Potter, with John Hollingsworth as the guest expert.

Mr. Cooper should develop into a good radio personality. Although the questions were not too difficult for anyone with a quite reasonable musical background, I thought he helped them to their answers rather a bit too much, but whether this was under orders or not, I would not know. Thus, in playing a line or two of the Elgar Violin Concerto recorded by Menuhin at 15 years of age, the panel was not only asked to name the work but to give the age of the solo violinist as well. As Menuhin is about the only violin prodigy of modern times, half the answer was, more or less, gratuitously handed out. Caryl Brahms had no difficulty in answering both parts of the question correctly. The programme was devised by Elkan Allan and Walter Todds.

I am reminded of a story of that great pianist-musician—two very different things—and wit, Moriz Rosenthal. A gentleman of more valour than discretion once challenged Rosenthal's claim to know the entire works of Chopin by heart. Rosenthal invited him to play any two bars from any of the works and he would identify them. Whereupon the gentleman sat down at the piano and, without touching the keyboard, got up again. Rosenthal, acting the part of one completely defeated, suddenly pretended to see the light. "They are the two bars rest from the B flat minor Scherzo," he said, "which occurs 12 times." Honours to both sides! It was certainly a brilliant question.

Menuhin gave a 45 minute eulogy of his boyhood master and lifelong friend Georges Enesco who died a few weeks ago. It was certainly an act of piety and, to me, it seemed he tried to claim for this undoubtedly distinguished musician and remarkable personality a far greater degree of greatness than was warranted. The famous pupil gave a very good broadcast and illustrated it with records of Enesco's music, mainly made by himself.

## Knowing Your Dialects

The new panel game "County Count" sounds extremely interesting. Commencing with a specimen of dialect, which has to be identified, the panel is given a number of questions apposite to the history, topography and legend of the county whose brogue, or dialect, sets the game going. It is a rather rare example of entertainment based on interesting knowledge and should prove successful. Somerset opened the venture. The genial and capable chairman was Victor Bonham-Carter.

A charming series of six "Literary Portraits"

Our Critic, Maurice  
Reeve, Reviews Some  
Recent Programmes

were given by St. John Irvine: repeats of previous broadcasts in the Northern Ireland Home Service. The six—Shaw, Wells, Yeats, Hardy, Galsworthy and Bennett—were all intimate friends of the lecturer, thus a personal as well as a literary appraisal made a fascinating quarter of an hour.

## Plays

It is many moons since Margaret Kennedy's and Basil Dene's "The Constant Nymph" first took a hold on West End playgoers. The Repertory Company of the Theatre Royal, York, gave a charming presentation of this appealing piece. Nicholas Selby was lifelike as the irresponsible musician Lewis Dodd, whose affair with the nymph wrecks his marriage—an affair he lets himself fall into unwittingly, as so often happens in real life. Eileen Kennelly as the nymph and Dorothy Clement as his wife headed a cast which was unusually capable right down the line.

"The Long Sunset" was R. C. Sheriff's speculations on what occurred in these islands when the Roman occupation came to an end in about A.D. 410. And a very interesting play they made. When no more soldiers could be spared to hold the country down, the natives had to re-acustom themselves to new masters from across the seas and the play follows a British family in the process. An almost all-masculine cast included P. Cunningham, G. Thomason, B. Mason, Geo. Merritt, Harcourt Williams, J. O'Connor and R. Bebb. John Gabriel was narrator.

Dotheboys Hall, in "Nicholas Nickleby," is generally considered to be a greatly exaggerated picture of private school life in the first half of last century. That such infamies were ever practised in this country is considered beyond the bounds of possibility. It is universally deemed an extremely amusing picture, which is the last thing Dickens ever meant it to be. In "Benevolent Teachers of Youth," V. C. Clinton-Badderley did a great service in collecting a vast amount of contemporary evidence from newspapers, courts of enquiry, inquests, etc., to establish that the great book was based on Dickens' own investigations of actual conditions then almost universally prevalent. Some of us knew it already. It was an excellent hour-long feature which should have done a lot of good.

"A Queen from Kendal," by Graham Sutton, was yet another Tudor period piece the BBC are so fond of putting on. It interested me though it didn't seem quite such good entertainment as one or two of the others.



### R.S.C. A4 HI-FIDELITY 25 WATT AMPLIFIER

1955 Model "Push-Pull" output. "Built-in" Tone Control Pre-amp. stages. Increased sensitivity. Even further improved performance figures. Includes 7 valves, specially designed sectionally wound output transformer, block paper reservoir condenser and reliable small condensers of current manufacturing. TWO SEPARATE INPUTS CONTROLLED BY SEPARATE VOLUME CONTROLS allow simultaneous use of "Mike" and Gram. or Tape and Radio, etc. etc. INDIVIDUAL CONTROLS FOR BASS AND TREBLE "Lift" and "Cut." Frequency response -3 db. 30-30,000 c/c. Six negative feedback loops. Hum level 66 db. down. ONLY 20 millivolts INPUT required for FULL OUTPUT. Certified harmonic distortion only 0.35% measured at 10 watts. Comparable with the very best designs.

ENTIRELY SUITABLE FOR SMALL HOMES OR LARGE HALLS, CLUBS, GARDEN PARTIES, DANCE HALLS, etc., etc. For ELECTRON ORGAN or GUITAR. For STANDARD or LONG-PLAYING RECORDS. FOR ANY "MIKE" or PICK-UP. H.P. TERMS ON ASSEMBLED UNITS. DEPOSIT 1/5 and twelve monthly payments of 1/1.

**9 GNS.**

**A PUSH-PULL 3-4 watt HIGH-GAIN AMPLIFIER FOR £3/19/6.** For mains input 200-250 v. 50 c/s. Assembled ready for use. Amplifier can be used with any type of Feeder Unit or Pick-up. This is not A.C./D.C. with "live" chassis, but A.C. only with 200-400 v. transformer units for 2-3 ohm speaker. Carr. 3/6. Descriptive leaflet, 7d.

**COLLARO 3-SPEED AUTO-CHANGER.** For standard 200-250 v. 50 c/s mains. Fitted high-fidelity crystal pick-up with separate plug-in heads with sapphire point stylus for long-playing or standard records. 7in., 10in. or 12in. Limited number. Brand New. Guaranteed. £7/19/6. Carr. 6/6.

**DEFIANT RECORD PLAYING UNITS** Turntable for standard 10in. and 12in. 78 r.p.m. records (fitted auto-stop) and high impedance magnetic pick-up mounted in attractive polished walnut finish drawer-type cabinet. Exceptional value at £5/19/6, plus 7/6 carr.

**B.S.R. MONARCH 3-SPEED MIXER AUTOCHANGER.** For standard 200-250 v. 50 c/s mains. Autochanges on all 3-speeds. Plays Ten mixed 7in., 10in. and 12in. records. Separate sapphire stylus for L.P. and 78 r.p.m. High fidelity type crystal pick-up. Minimum baseboard size needed 14in. x 12in. x 5 1/2in. high. Brand new, cartoned, at 9 gns. plus 5/6 carr. Or Deposit 4 gns. and six monthly payments 21/-.

**COLLARO HIGH FIDELITY MIXER AUTOCHANGERS.** Latest Model RC/54 Fitted Studio "O" high fidelity pick-up with dual point sapphire stylus for standard or long-playing records. Plays Ten 7in., 10in. or 12in. Intermixed at 33, 45 or 78 r.p.m. For 200-250 v. 50 c/s. A.C. mains. Brand New. Cartoned at less than wholesale price. Only 10 gns. Carr. 7/6 or Deposit 4 gns. and 7 monthly payments 1/4.

**BATTERY SET CONVERTER KIT** All parts for converting any type of Battery receiver to All Mains. A.C. 200-250 v. 50 c/s. Kit will supply fully smoothed H.T. or 120 v. 90 v. or 60 v. at up to 40 mA. and fully smoothed L.T. or 2 v. at 0.4 to 1 a. Price, complete with circuit, wiring diagrams and instructions, only 48/9. Or ready to use, 8/8 extra.

**ALL DRY BATTERY RECEIVER MAINS UNIT KIT.** A complete set of parts for construction of a Unit (housed in metal case) to replace Batteries where A.C. Mains supply is available. Input 200-250 v. 50 c/s. For receivers requiring 90 v. 10/20 mA. and 1.4 v. 125-250 mA. fully smoothed. Price, complete with circuit, only 37/9. Or ready for use 45/6. Size of unit, 5 1/4 x 4 1/2 in.

Terms: C.W.O. or C.O.D. NO C.O.D. under £1. Post 1/- extra under 10/-; 1/6 extra under £1; 2/6 extra under £3. Open 9 to 5.30; Sats. until 1 p.m. Catalogue 6d., Trade List 5d. S.A.E. with all enquiries.



Size approx. 12-9-7in. For A.C. mains 200-230-250 v. 50 c/s. Outputs for 3 and 15 ohm speakers. Kit is complete to last nut. Chassis is fully punched. Full instructions and point-to-point wiring diagrams supplied. Unapproachable value at 9 gns. or ready for use, 50/- extra. Carriage 10/- if required, cover as illustrated can be supplied for 17/6.

**H.M.V. LONG-PLAYING RECORD TURNTABLE WITH CRYSTAL PICK-UP** (Sapphire Stylus). Speed 33 1/3 r.p.m. For A.C. mains 200-250 v. Limited supply. Brand New, cartoned. Perfect. Only £3/19/6. Plus carr. 5/- (Normal price £8 approx.)

**FOUR STAGE RADIO FEEDER UNIT.** Design of a High Fidelity Tuner Unit T.R.F. L. & M. Wave. Full decoupling. Self-contained heater supply. Only 250-400 v. 10-15 mA. H.T. required from main amplifier. Three valves and low distortion Germanium diode detector. Flat-topped response characteristic. Loaded H.F. coils. Two variable-Mu controlled H.F. stages. 3-Gang condenser tuning. Detailed wiring diagrams, parts lists, and illustration, 2/6. Total building cost, £3/15/-.

### R.S.C. 4-5 WATT A5 HIGH-GAIN AMPLIFIER

A highly sensitive 4-valve quality amplifier for the home, small club, etc. Only 50 millivolts input is required for full output so that it is suitable for use with the latest high-fidelity pick-up heads, in addition to all other types of pick-ups and practically all mikes. Separate Base and Treble Controls are provided. Unsurpassed full long-playing record equalisation. Hum level is negligible being 71 D.B. down. 15 D.B. of negative feedback is used. H.T. of 300 v. 25 mA. and L.T. of 6.3 v. 1.5 a. is available for the supply of a Radio Feeder Unit, or Tape Deck preamplifier. For A.C. mains input of 200-230-250 v. 50 c/s. Chassis is not alive. Kit is complete in every detail and includes fully punched chassis (with baseplate) with green crackle finish, and point-to-point wiring diagrams and instructions. Exceptional value at only £4/15/-, or assembled ready for use 25/- extra, plus 3/6 carr.



**R.S.C. MASTER INTERCOMM. UNIT.** For Office or Works Intercommunication. High Gain Amplifier with Push-Pull output. Attractive wood walnut cabinet. Provision for 4 individually switched Listen-Talk Back Units can be supplied in walnut veneered cabinets at 35/- each. Master Unit ready for use, 7 gns. Carr. 3/6.

### R.S.C. 10 WATT "PUSH-PULL" HIGH-FIDELITY AMPLIFIER A3

Ideal for the quality enthusiast in the home or small hall. Two different inputs can be simultaneously applied and controlled by separate volume controls. Any kind of Pick-up is suitable and most microphones. Tone controls give full Long-Playing record equalisation for uncorrected Pick-ups. Sensitivity is very high. Only 130 millivolts required for full output. H.T. and L.T. available for Radio Feeder unit.

Complete with integral Pre-amp. Tone control stage (as A4 amplifier), using negative feedback, giving hump-free individual bass and treble lift and cut tone control. Six Negative Feedback Loops. Completely negligible hum and distortion. Frequency response -3 db. 30-20,000 c.p.s. Six valves. A.C. mains 200-230-250 v. input only. Outputs for 3 and 15 ohm speakers. Kit of parts complete in every detail. Plus 7/6 carriage. **7 GNS.**

Or ready for use, 45/- extra. Illustrated leaflet 6d. Cover as for A4 is suitable. H.P. TERMS ON ASSEMBLED UNITS. DEPOSIT 2/6 plus 10/- carriage, and nine monthly payments 1/6. **HIGH-FIDELITY MICROPHONES** in stock. Keep cash prices or H.P. terms if supplied with amplifier.

**P.M. SPEAKERS.** All 2-3 ohms. 6in. Plessey, with 5,000 ohm output trans. 16/9. 8in. Plessey, 16/9. 10in. W.B. "Stentorian" 3 or 15 ohm type HF1012 10 watts, high-fidelity type. Highly recommended for use with any of our amplifiers. £42/9. **M.D. SPEAKERS** 2-3 ohms. 8in. R.A. Field, 1,000 ohms. 11/9. 10in. R.A. Field, 1,000 ohms. 23/9.

**VOLUME CONTROLS** with long (1in. diam.) spindles, all valves less switch, 2/9; with S.P. switch, 3/9; with D.P. switch, 4/6.

**COAXIAL CABLE** 75 ohms, 1in., 7d. yard. Twin Screened Feeder, 10d. yard.

#### SELENIUM RECTIFIERS

L.T. Types H.W.	H.T. Types H.W.
6-12 1 a. H.W. 2/8	150 v. 40 mA. 3/9
F.W. Bridge Type	250 v. 50 mA. 5/9
6/12 v. 1 a. 4/9	250 v. 80 mA. 7/9
6/12 v. 2 a. 8/9	RM4 250 v. 80 mA. 7/9
6/12 v. 6 a. 19/9	250 v. 11/9
6/12 v. 10 a. 35/-	

### R.S.C. 3-4 WATT A7 HIGH-GAIN AMPLIFIER

Appearance and Specification, with exception of output wattage, as A5. Complete Kit, with diagrams, £3/15/- Assembled £1 extra. Carr. 3/6

**PICK-UPS.** Collaro high fidelity low impedance magnetic type, with matching transformer. Only 35/-, Gold ring high impedance magnetic 23/9. Both types Brand New Boxed.

**CHASSIS** (Un-drilled Aluminium) 18 s.w.g. amplifier (4-sided)  
 14in. x 10in. x 3in. ... .. 7/11  
 16in. x 10in. x 3in. ... .. 8/3

**BATTERY CHARGE KITS**  
 For mains 200-250 v. 50 c/s.  
 To charge 6 v. acc. at 2 a., 25/6.  
 To charge 6 or 12 v. acc. at 2 a., 31/5.  
 To charge 6 or 12 v. acc. at 4 a., 49/9.  
 Above consist of transformer, full wave rectifier, fuses, fuseholders and steel case. Any type assembled and tested 8/9 extra.

**THE SKYFOUR T.R.F. RECEIVER.** A design of a 3-valve 200-250 v. A.C. Mains receiver with selenium rectifier. It consists of a variable Mu high-gain H.F. stage followed by a low distortion anode bend detector. Power pentode output is used. Valve line up being 6X7, 6BE6, 6BE7. Selectivity and quality are well up to standard, and simplicity of construction is a special feature. Point to point wiring diagrams, instructions, and parts list, 1/9. This receiver can be built for a maximum of £4/19/6 including attractive Brown or Cream Bakelite or Walnut veneered wood cabinet 12 x 6 1/2 x 5 1/2 in.

**RADIO SUPPLY CO. 32, THE CALLS, LEEDS, 2**

**BENSON'S  
BETTER  
BARGAINS**

**BRAND NEW. ORIGINAL CARTONS.**  
**R.F. UNITS.** TYPES 28 or 27, 27/8; 24, 10/8 (Postage 2/6); R.F.25, 50/8; 10/8. **4. AMPLIFIERS** 17/3 16.5 mc/a, with valves, 22/6 (post 2/2). **R1155** Coil-packs, new, 12/8; used, 9/6. **I.F. Filters** 2/6. **Condensers** tub. 3 x .1 mfd., 1/-; **AERIAL RELAYS** (eo-axial) e/o 12/24 v. 7/6. **DYNAMOTORS, D.C.** 12 v. input, 250 v. 60 mA, and 6.3 v. output, 1.2 A, field, 7/6. **Filters** for these, 2/6. **EDDYSTONE** 12 v. to 190 v. 75 mA, cased, 15/6 (Post 2/2). 11 v. to 300 v. 200 mA, cased, 13/6 (carr. 7/6). **CLOCKWORK** Contactors, 2 impulses per sec., 8/8. Remote contactor, 2/6. **TR1198** with all valves, less 21s. 45/- (carr. 8/8). **R1355**, new improved type, 37/6 (carr. 7/6). **TR1434-TR.** 50, 6 valves, 17/6; (R. 71, 8 valves, 22/6; Mod./amp, 165, 5 valves, 15/- (post 2/6 each). **R1392A** 100-150 mcs, 13 valves, used, good cond., 25/10/- (carr. 10/-). **REOSTATS,** 25 A, 0.4 Ω, with worm-drive slider, 12/8. **BP101,** 45 mc/a, with 10V/9R1, 2V/R92, new, 45/- (carr. paid). **VIBRAPACKS.** PCR, D.C. 12 v. to 250 v. 80 mA, smoothed, filtered, 17/8 (carr. 5/-). **VIBRATORS,** 12 v. 4 pin or 6 pin, 7/6. **CONDENSERS,** electro, 12 v. 12 samples, range 4 mfd to 1,000 mfd, 7/8 (post free). Bak. tubular, 0.1/1.2 kV; .5/3.0 v.; .25/800 v., 8d. each; .002/2.5 kV; .05/2.5 kV; .25/1.5 kV, 1/- each. **USA** **Batteries,** 600 v.v., 2 mfd, 1/8; single, 1/- or 25. 9d.; double, 1/- or 25. 3/-; 1 mfd, 1/3; treble, 1/-, 1/6.

**METERS-BRAND NEW BOXED**

FSD	Scale	Size	Type	Fit	Price
20mA		2 1/2"	MC	Pr.Rd.	10/6
10mA		3 1/4"	MC	Pr.Rd.	7/-
10mA		4 1/4"	MC	Pr.Rd.	20/-
20mA	290A	3 1/4"	MC	Pr.Rd.	7/6
20mA		4 1/4"	MC	Pr.Rd.	8/-
40 & 120mA		2 1/2"	MC	Pr.Sq.	7/6

List and enquiries, S.A.E. please! Terms: Cash with order. Postage extra. Immediate despatch.

Callers and Post. **W.A.BENSON (PW)** 309 Raddon Rd., Liverpool 13. **Callers S U P E R R A D I O (W)chapel LTD.,** Whitechapel, Liverpool 1. **ROY 1130.**

**LYONS RADIO LTD.**

3, GOLDHAWK ROAD, Dept. M.P., SHEPHERDS BUSH, LONDON, W.12.  
 Telephone: SHEpherds Bush 1729

**BAND III CONVERTER.**—Complete coil kit by Teltron Co., with circuit, point-to-point wiring diagram, alignment instructions, etc. Provides the basis for an efficient, easy-to-make, 2-valve converter which can be relied upon to give good results. For use with T.R.F. or superhet Band I TV receivers. **PRICE 15/-**, post 6d. Metal chassis, ready drilled, with mounting base. **PRICE 3/9**, post 6d. Instruction leaflet only. 6d. inc. post.

**ELECTROSTATIC LOUSPEAKERS.**—Reproduce those missing frequencies beyond 8-10 Kc/s and reproduce frequencies up to 20 Kc/s. By adding one of these units to existing domestic loudspeaker systems the remarkable quality of the H.F. transmissions are the superb brilliance of modern long-playing recordings can be faithfully reproduced. Full instructions for incorporating these speakers into existing installations are included with every speaker.  
**TYPE LSH75.** Size 3 x 3 x 1/4". For handling up to 6 watts. **PRICE 12/6.**  
**TYPE LSH100.** Size 5 x 4 x 1/4". For handling up to 20 watts. **PRICE 21/-.**

**MICROPHONE/HEADPHONE SETS.**—Made by T.M.C. type AP12500, in brand new condition. Microphone hangs on chest or can be mounted on wall or bench. Double headphones are rubber cushioned with headband. On/off switch to mike. Fitted with 9ft. connecting cord. Very strongly made. For direct use, just link up together with flex (see our September advt., page 671) as required, no batteries or amplifier required. Excellent communication up to 1 mile. **PRICE 19/6** per set or 37/6 per pair. Postage 2/6.

**Best Buy at Britain's**

**HEAVY DUTY L.T. TRANSFORMERS.**—Standard primary. Type (A) 30 v. 36 amp. or Type (B) 50 v. 16 amp. 6in. x 5 1/2in. x 8in. high. Weight 24lbs.  
**BRAND NEW**, not ex-Govt. Suitable for coil heating, chargers, etc. 55/- each plus 5/- carriage.

**BAND III CRYSTAL CALIBRATORS.**—By Marconi Instruments. A.C. mains. Directly calibrated, 170-240 Mc/s. 5 Mc/s crystal check. Grey instrument case, 15 1/2in. x 10in. x 10in. Complete with crystal, valves, spare set of valves and instruction manual. **BRAND NEW** in original transit case. **SNIP, £5.19.6** plus 10/6 carriage.

**RECEIVER R1132A.**—Covers 100-124 Mc/s with variable tuning. Ideal for conversion to F.M. Complete with 11 valves and circuit diagram. Brand new condition. Regret owing to limited number these are available for callers only. **Price 65/-.**

**COMMUNICATION RECEIVERS TYPE TR1155A.**—For world-wide reception. Brand new and air-tested, **£11.19.6**. Slightly soiled, **£9.19.6**. Used models, **£7.19.6**. **R1155H**, with super slow motion drive, brand new, **£12.10.0**, Carriage 10/6 extra. Free booklet supplied with each receiver.

**A.C. MAINS POWER PACK & OUTPUT STAGE.**—These enable the R1155 to be used on the mains WITHOUT ANY MODIFICATION. Three types available, **£4.10.0**, **£5.5.0**, and de-luxe model with 8in. speaker, **£6.10.0**. Carriage 5/-. All Power Packs guaranteed six months. **SAVE £££. DEDUCT 10/- WHEN PURCHASING RECEIVER AND POWER PACK TOGETHER.** Send S.A.E. for full details of Power Packs and Receivers or 1/3 for booklet.

**RECEIVER TYPE CR100.**—A super communications receiver covering 60 kc/s to 30 mc/s in six bands. Built-in A.C. mains power pack. 2 R.F. stages, 3 I.F. stages variable selectivity Xtal Filter, B.F.O., etc. Superb condition, complete with new valves and air tested. A bargain at **£20**, plus 1/- carriage.

**RECEIVER 25/73 (TR1196).**—Superhet receiver with 455 kc/s I.F.'s. Complete with all valves; 2 EF39, 1 EK32, 2 EF36, 1 EB33. Brand new with full conversion data. **Price 30/-**, price 2/6 post.

**AVO "ALI DRY" BATTERY ELIMINATOR.**—Government surplus. For A.C. mains 200/250 volts, output 1.4 v. at 300 mA, and 65 volts at 10mA. Employs metal rectifiers and VS70 stabiliser. Size 8 1/2in. x 5 1/2in. x 3 1/2in. Suitable for all personal portable type sets, full instructions supplied. New in cartons and air tested prior to despatch. **Price 39/6**, plus 2/6 post.

**H.R. HEADPHONES.**—Consists of two high-resistance earpieces with adjustable metal headbands. Price, less cord, 6/6.

**PACKARD BELL PRE-AMPLIFIERS.**—Suitable for conversion to baby alarm, amplifier, etc. Contains miniature relay, complete with 6SL7, 207, Circuit, Instruction Book, etc. **BRAND NEW, U.S.A. 12/6** each.

**R.C.A. AMPLIFIER.**—For A.C. mains operation 180/250 v. 12 watts output into 600/157.5/5 ohms, input impedances of 250 and 30 ohm, suitable for mike and gram. Brand new, in handsome case, size 17in. x 9 1/2in. x 1 1/2in. deep. Uses 4-6J7, 6SL6 and 6U4. **PRICE ONLY £9.19.6**, less valves, or **£12.19.6** with boxed valves, carriage 10/6.

**MINIATURE MODEL MOTORS.**—2in. long x 1 1/2in. diam., 3/16in. diam. spindle, weight 5 ozs. Will work from 6-volt dry battery and are very reliable. Ball bearings. 10/6 each. With blower, 12/6 each.

**METER BARGAIN.**—2 1/2in. Projection type. Two ranges, 12 and 120 volts, with multiplier. Brand New and Boxed, 5/9 each.

**E.M.I. OUTPUT METER.**—Desk Type, consists of 2 1/2in. 1 mA, meter with full wave bridge rectifier. Range 0-500 milliamps and 0-5 watts. Brand New and Boxed, **ONLY 35/-**, each, plus 1/6 post.

**EDDYSTONE ROTARY POWER UNITS.**—In grey metal case. Input 12 v., output 180 v. at 60 mA. Complete with all smoothing and filtering. **BRAND NEW, 19/6**, plus 2/6 carriage.

**CHARLES BRITAIN (RADIO) LTD.**  
 11, Upper Saint Martin's Lane, London, W.C.2. **TEM 0545**  
 Shop hours 9-6 p.m. (9-1 p.m. Thursday)  
**OPEN ALL DAY SATURDAY**

**COPPER WIRE**

S.W.G.	ENAMELLED		TINNED	
	2 ozs.	4 ozs.	2 ozs.	4 ozs.
16	1/6	2/3	1/6	2/3
17	1/6	2/4	1/6	2/4
18	1/6	2/5	1/6	2/5
19	1/6	2/6	—	—
20	1/7	2/7	1/7	2/7
21	1/7	2/8	1/8	2/8
22	1/8	2/9	1/8	2/9
23	1/9	2/10	1/9	2/10
24	1/9	2/11	1/9	2/11
25	1/10	3/-	1/10	3/-
26	1/10	3/1	1/10	3/1
27	1/11	3/2	1/11	3/2
28	1/11	3/3	1/11	3/3
29	2/-	3/4	2/-	3/4
30	2/-	3/5	2/-	3/8
31	2/1	3/6	2/2	3/9
32	2/1	3/7	2/3	3/11
33	2/2	3/8	2/4	4/1
34	2/2	3/9	2/5	4/3
35	2/3	3/10	2/6	4/5
36	2/3	3/11	2/8	4/8
37	2/4	4/1	2/9	4/11
38	2/5	4/3	2/11	5/2
39	2/6	4/5	3/-	5/5
40	2/7	4/7	3/2	5/9

**POSTAGE EXTRA.**  
**POST ORDERS ONLY PLEASE.**  
 Send stamp for comprehensive lists.  
**CRYSTAL SET**  
 INCORPORATING THE SILICON **CRYSTAL VALVE**  
 Adjustable Iron Cored Coil.  
**RECEPTION GUARANTEED**  
 Polished wood cabinet, 15/-, post 1/-  
**A REAL CRYSTAL SET, NOT A TOY**  
**POST RADIO SUPPLIES**  
**33 Bourne Gardens, London, E.4**

**THE MODERN BOOK CO.**

BRITAIN'S LARGEST STOCKISTS OF BRITISH AND AMERICAN TECHNICAL BOOKS.  
**The A.R.R.L. Antenna Book**, by A.R.R.L. New Edition. 18s. 0d., postage 9d.  
**Practical Wireless Service Manual**, by F. J. Camm. 17s. 6d., postage 6d.  
**Frequency Modulation Tuner Units for Fringe and Local Area Reception**, by The Radio Constructor. 2s. 0d., postage 2d.  
**Telecommunication**, by A. T. Starr. 35s. 0d., postage 9d.  
**Radio Data Charts**, by R. T. Beatty, revised by J. Sowerby. 7s. 6d., postage 6d.  
**Radio-Control Handbook**, by H. G. McEntee. 18s. 0d., postage 4d.  
**Wireless World F.M. Tuner**, by S. W. Amos and G. Johnstone. 2s. 0d., postage 2d.  
**Handbook of Line Communication**, Volume I, by the Royal Signals. 30s. 0d., postage 1s.  
**Radio Engineers' Servicing Manual**, by E. Molloy. 42s. 0d., postage 1s.  
**The Radio Amateurs' Handbook**, by A. R. L. 1955. 30s. 0d., postage 1s.  
**Radio Designer's Handbook**, by P. Langford-Smith. 42s. 0d., postage 1s.  
**High Fidelity Techniques**, by James R. Langham. 8s. 0d., postage 4d.  
**Simple Electronic Musical Instruments for the Constructor**, by Alan Douglas. 5s. 0d., postage 3d.  
**Radio Valve Data**, by "Wireless World." 3s. 6d., postage 3d.  
**19-23, PRAED STREET, LONDON, W.2.**  
 'Phone: PADdington 4185.  
 Open 6 days 9-6 p.m.  
 Please write or call for our catalogue.

# Open to Discussion



## Neon Lamps

**SIR,**—May I suggest for your consideration one or more articles on the above subject? Although the characteristics are stated in several works, the treatment is generally rather advanced and where circuits are mentioned the values of the components are often omitted.

Readers would be interested, I imagine, in a simple, concise and explicit statement so that there would not be any doubt in constructing the circuits suggested and making the most use of the apparatus.

Sometimes a neon lamp or tube is acquired whose striking voltage, operating voltage and extinguishing voltage and the necessary minimum value of series resistor are unknown. A description would be useful of the method of ascertaining them; perhaps by connecting the tube in series with a  $0.5\text{ m}\Omega$  1 W. resistor and a milliammeter to a variable voltage source, such as a Variac, with a voltmeter across the tube. An explanation might be given as to why some neon tubes are suitable only for A.C. or D.C. and others for both A.C. and D.C.

Among the uses, to be accompanied by full detailed constructional information, might be mentioned:

Detection of live and earthed lines.

How to make a pencil or prod with a neon tube in circuit and so that it is safe to touch one pole.

Discrimination between A.C. and D.C. and indication of polarity.

Insulation resistance of capacitors and leakage.

Approximate determination of values of capacity.

Use as voltage stabiliser.—H. G. (Surrey).

## School Radio

**SIR,**—Your readers may be interested to know that we are including amateur radio as one of the subjects a pupil may take in this school.

Our reasons are as follows: Once the basic subjects have been adequately covered, we believe that a child may best be helped to grow into a mature and responsible adult by using his real interests as a means through which to educate him. We find that a number of our boys are very keen indeed on amateur radio and we have planned a scheme of work around this topic which will strengthen the English, mathematics, science, geography, etc., of the pupils following it, as well as giving them a basic knowledge of radio itself. It will be clear, then, that our aim is in no way vocational, but is directed to improving the pupil's general education.

Our difficulty is equipment. As your readers are no doubt aware, educational funds for such a purpose are very limited indeed. If any of your readers have equipment lying idle, we should be most grateful for it. They may rest assured that such gifts, however

small, would be most gratefully received and put to the fullest possible use.

We should, of course, acknowledge such gifts promptly and refund postage.—A. W. ROWE (Headmaster, Holmer Green C. School, nr. High Wycombe, Bucks).

## Signal Generators

**SIR,**—I have seen quite a few letters by readers criticising the price of signal generators, for the sole purpose of aligning a constructor's superhet receiver.

One method I have found to be quite satisfactory with a little care, regarding harmonics and dial misplacements, is to employ the local oscillator in another superhet, most probably already aligned.

With a yard or so of wire as the aerial to the constructor's set, placing it around, or quite near, the aligned receiver gives quite enough coupling. The frequency of the local oscillator is, of course, the dial

reading of the receiver plus the I.F., provided, of course, the dial is accurate, if not reference can be made to known broadcast stations.—A. T. DAVIES, A.M.I.E.T. (Ilfracombe).

## "Excellent Series"

**SIR,**—Your contributor Mr. O. J. Russell ("Transmitting Topics") is writing an excellent series, and I for one would welcome publication of these articles in book form, as it would prove an invaluable reference.

With regard to receiver conversion, I am tackling the R1155A and would welcome any advice from readers who have removed the D.F. coil assembly.—L. C. MARSHALL, G3IGN (Sandridge).

## Contacts Required

**SIR,**—I am a pianist in lodgings, without a piano, and would welcome contacts with owners of tape-recorders in the London, Surrey or Brighton areas. Preferably those with pianos, who are either vocalists or instrumentalists themselves, for practice and mutual assistance with experiments in tape recording.—H. REDGEWELL (Redhill).

## An F.M./A.M. Receiver

**SIR,**—I notice that on your discussion page in the September issue, you mention that we are to have an F.M./A.M. receiver.

As the BBC now cater for ordinary use on F.M. is it too much to hope that the proposed receiver would take in only short and medium short waves, say, 180 m. to 5 m. This, I feel, would satisfy the vast majority of readers.

*Whilst we are always pleased to assist readers with their technical difficulties, we regret that we are unable to supply diagrams or provide instructions for modifying surplus equipment. We cannot supply alternative details for receivers described in these pages. WE CANNOT UNDERTAKE TO ANSWER QUERIES OVER THE TELEPHONE. If a postal reply is required a stamped and addressed envelope must be enclosed with the coupon from page iii of cover.*

How about giving us a large dial with mechanical bandsread, after all we are supposed to be getting away from the "cats-whisker" age? Turret switching would be another refinement also.—W. R. WILLIAMS (Ewell).

### "Radio Jack"

**SIR**—As a regular reader of your helpful magazine, I imagine I am not alone in asking for an article on constructing a "Radio Jack" for plugging into a tape recorder.—REV. A. MORGAN DERHAM (Chenies).

### Pocket Receivers

**SIR**—I absolutely agree with Thernion's remarks concerning the complete absence of any worthwhile designs for truly compact pocket receivers, and with such an abundance of miniature components available these days I cannot understand why this should be so.

As a mechanical engineer I must admit here and now to being unqualified to produce a detailed working solution myself, but may I be allowed with all modesty to suggest a basic specification from which a radio designer might draw inspiration?

Ferrite rod aerial feeding crystal diode detector stage tuned for Home and Light programmes only, through pre-set condenser selection.

Single- or two-valve output stage—lowest possible working voltages—driving one miniature earphone piece (loudspeaker illogical, due to "bulkiness" and "short battery life" bogies).

There must be very many people eager for such a design, especially those like myself who travel a lot.

Perhaps an open competition for readers of your magazine, with a small prize attached, might be stimulative?—D. S. FREEMAN (Leamington Spa).

### Correspondent Wanted

**SIR**—I am 14½ years of age and would like, if possible, to contact through the medium of your excellent magazine an enthusiast of my own age interested in wireless as a whole with a view to correspondence.—M. BROUGHTON (93, Beckley Road, Broxtowe Estate, Nottingham).

### Show Discomforts

**SIR**—Although the actual exhibits, the stands and the friendliness of the various staffs left nothing to be desired, the whole organisation was not as good as it might have been.

Throughout the whole vast hall and galleries there were no seats anywhere, except on some of the stands an odd chair or two. People were squatting about and spreading newspapers on the floor to sit on. There were no hot meals available under 12s.6d.

A great opportunity was lost and, judging by many remarks overheard, a lot of harm was done by this lack of elementary care and organisation. Much more could have been made of the popular radio and television stars and they could surely have mixed and chatted with the visitors, signing autographs, etc. One hears that the German Radio Exhibition at Dusseldorf held the same week was considerably better organised in many ways.—A. J. SWEENEY (Gloucester).

## THE NATIONAL RADIO SHOW

(Continued from page 670)

areas to elaborate "trees" for fringe conditions.

A factor of great assistance is that the dimensions of aeriels for both the two "new" bands are quite small.

The single-band aeriels are obtainable for solo mounting and for attachment to existing aeriels. For television there were two-band aeriels in two types, those for where it is known that the two transmitters will be in the same general direction, and those where the aeriels must point in different directions and be adjustable, one to the other.

V.H.F. aeriels (F.M.) were obtainable for attaching to television masts, and at least one combined TV-V.H.F. aerial is made.

Simplest of all, apart from indoor aeriels, were the clip-on elements that adapt a Band I aerial for two-band reception, where the Band III signal is good.

### Excellent Work by Services

I cannot conclude without a mention of the excellent shows put on by the three Services. Visitor-

participation was the keynote. There was a Forces Broadcasting studio relaying music and messages to men throughout the world. The programmes were introduced by celebrities. You could work a gun-turret or experience the sensations of high-speed flight. And you could play parlour-games against the Navy's electrical gadgets—and lose every time!

The Navy had a model ship in a water-tank to demonstrate the explosion of a magnetic mine and the film-set of the submarine control-room in "Cockleshell Heroes." For the Army, the Royal Corps of Signals showed the latest "walkie-talkies" and a whole transmitting station on a one-ton truck, together with models of some of the headquarters in the network. The R.A.F. had a model airfield showing a typical air-traffic control layout and the cockpit of a Canberra to demonstrate the principles of "blind" landing.

By no means less fascinating were the recordings of airport-controller-to-pilot at London Airport, together with a display of the equipment used. This Show was put on by the Ministry of Civil Aviation in collaboration with the Radio Industry Council.

Editorial and Advertisement Offices:

"Practical Wireless," George Newnes, Ltd., Tower House, Southampton Street, Strand, W.C.2. Phone: Temple Bar 4363.

Telegrams: Newnes, Rand, London.

Registered at the G.P.O. for transmission by Canadian Magazines Post.

The Editor will be pleased to consider articles of a practical nature suitable for publication in "Practical Wireless." Such articles should be written on one side of the paper only, and should contain the name and address of the sender. Whilst the Editor does not hold himself responsible for manuscripts, every effort will be made to return them if a stamped and addressed envelope is enclosed. All correspondence intended for the Editor should be addressed: The Editor, "Practical Wireless," George Newnes, Ltd., Tower House, Southampton Street, Strand, W.C.2. Owing to the rapid progress in the design of wireless apparatus and to our efforts to keep our readers in touch with the latest developments, we give no warranty that apparatus described in our columns is not the subject of letters patent. Copyright in all drawings, photographs and articles published in "Practical Wireless" is specifically reserved throughout the countries signatory to the Berne Convention and the U.S.A. Reproductions or imitations of any of these are therefore expressly forbidden. "Practical Wireless" incorporates "Amateur Wireless."

# UNDECIDED?



**TO BE SURE GET THE RODING 22-circuit HOME**



"If you want to save time and money!"

## CONSTRUCTOR'S HANDBOOK

Our latest issue is beautifully printed on glossy art paper with a full colour cover! It is packed with technical data, set building and servicing hints, facts and formulae, resistance colour code, soldering hints, etc., together with full descriptions, parts lists and circuits of outfits as listed below. Send 2/6 (plus 3d. post). (Also obtainable through W. H. Smith branches, Foyles, Booksellers and Component Stockists).

- \* 3-valve Superhet Feeder Unit
- \* 4-valve Feeder unit (R.F. stage), with hi-fi and gram. switching
- \* Amplifier/Power pack for both above
- \* 5-valve superhet A.C. with gram.
- \* 5-valve superhet A.C./D.C.
- \* 6-valve superhet A.C. (R.F. stage)
- \* 6-valve superhet A.C./D.C. ( ... )
- \* Simple Continuity Tester
- \* Magic Eye Unit
- \* Modified 40 Feeder Unit Circuit
- \* "P.W." Coronet AC4 Superhet
- \* "P.W." Coronet A.C./D.C. 4 Superhet
- \* "P.W." Coronet Battery 4 Superhet
- \* Tape Recorder
- \* 3in. Oscilloscope
- \* 8-valve Communications Receiver
- \* Signal Tracer
- \* 5-watt quality amplifier
- \* 10-watt high-fidelity push-pull amplifier
- \* Signal Generator
- \* Crystal Set
- \* Local station high-fidelity T.R.F. feeder unit

Our famous "Easy-as-A.B.C." FULL SIZE Construction Sheets are available for most of the above enabling even the beginner to get first-class results first time! Coil Packs and I.F.T.'s pre-aligned. We can supply ALL parts.

**NEVER BEFORE HAS THERE BEEN A BOOK SO VALUABLE TO NOTICE AND EXPERT ALIKE! DON'T DELAY SEND TODAY!**

## RODING LABORATORIES

(Dept. TC3), Bournemouth Airport, Christchurch, Hants.

## VALVES

### SAME DAY SERVICE

#### All Guaranteed New and Boxed

1.4v. midget, 1R5, 1S5, 1T4, 1S4, 3S4, DAF91	DF91, DK91, DL92, 7/3; any 4 for 28/6
1A7GT	6L6G 9/6, 50L6GT 8/6, EL41 11/8, 6LD20 9/8, 80 8/6, EL91 5/-, 6P25 14/6, AZ31 10/6, EY51 12/-, 11/6, 6P23 19/6, CL33 12/6, E240 8/6, 1D5 11/-, 6QTGT 9/-, DL 3/6, GZ32 15/-, 1H5GT 6SN7GT DAC32 KT63 7/6
1N5GT	11/6, 6U4GT 11/6, DCC90 10/6, IN78 14/6, 11/6, 8V6G 7/6, DF33 8/6, P61 3/6
1R5	7/3, 6V6GT 7/6, DH77 8/6, PCC84 10/8, 1S5 7/3, 6X4 7/6, DK32 11/6, PCF90 10/-, 1T4 7/3, 6X5GT 6/9, DK92 7/6, PEN46 8/6, 3A5 10/6, 7B7 8/6, DL33 11/6, PL33 11/6, 3Q5GT 7C5 8/6, DL35 11/6, PL81 11/6, 354 7/3, 7H7 7/6, EB91 6/6, PL42 9/6, 3V4 8/6, 7S7 8/6, EBF40 10/-, PY80 9/6, 5U4G 8/6, 7Y4 8/6, EBF50 10/-, PY81 10/-, 5Y3GT 7/9, 10C1 12/6, 10/6, PY82 7/9, 5Z4G 9/-, 10P1 10/-, ECC40 15/6, GZ30 17/-, 6AK5 6/6, 10P13 10/-, ECC41 9/-, T41 13/-, 6AL5 6/3, 10P14 12/6, ECC33 U24 17/6, 6AM5 5/-, 12AT7 9/-, 10/6, U25 12/-, 6AM6 6/3, 12AU7 9/-, ECC91 7/-, U50 7/9, 6AT6 8/6, 12J7GT ECH35 U78 8/6, 6BA6 7/6, 10/6, 11/9, U261 10/-, 6BE6 6/6, 12K7GT ECH42 10/-, U404 9/-, 6BW6 7/6, 9/6, ECH81 10/-, UBC41 9/-, 6BX6 7/6, 12K8GT ECL80 9/6, UBF80 10/6, 6C4 7/6, 10/6, EBF37A 11/6, UCH42 9/9, 6C9 8/6, 12Q7GT 9/8, 11/6, UCH43 9/9, 6F1 13/6, 6/6, EBF39 6/6, U44 8/6, 6F6G 7/6, 20P2 11/6, EBF40 17/6, UF42 13/6, 6F14 12/-, 20L1 10/9, EBF41 8/6, U441 9/9, 6J6 7/-, 20P1 15/-, EBF42 17/6, U08 10/9, 6J7GT 7/6, 25L6GT EBF50 7/6, U08 17/-, 6KTG 8/6, 8/9, EBF90 10/-, UY41 9/-, 6KTGT 9/-, 25Z4G 7/6, EBF95 17/6, WTT 5/-, 6K9C 8/6, 35L6GT 7/6, EBF91 6/3, Y63 7/6, 6K8GT 9/-, 35Z4GT 7/6, EBF92 5/-, Z66 19/6, 6K25 11/9, 35Z5GT 7/6, EBF95 10/6, Z77 8/3

Postage 4d. per valve extra.

**READERS RADIO**  
24, COLBERG PLACE, STAMFORD HILL, LONDON, N.16. STA. 4587

**Trace the Trouble in a Trice**

**PIFCO ALL-IN-ONE RADIOMETER**

- \* Circuit Test
- \* L.T. & H.T. Test
- \* mA Test
- \* Valve Test

Use the PIFCO All-in-one RADIOMETER for the practical testing of all types of radio and electrical apparatus. You can carry out continuity and resistance tests, check

H.T., L.T. and G.B. voltages, also Household Appliances, Car Lighting Systems, Bell Circuits, etc. May be used on A.C. or D.C. Mains.

Obtainable from your local dealer. ONLY **32/6** COMPLETE  
Write for informative folder to:—  
**PIFCO LTD., WATLING ST., MANCHESTER 4**  
and 36-37, UPPER THAMES ST., LONDON, E.C.4.

## G2AK This Month's Bargains G2AK

**ABSORPTION WAVEMETERS.**—3.5, 7, 14, 21 and 28 mc/s Ham bands marked on scale. Complete with indicator bulb. A MUST for any Ham Shack. ONLY 15/- each. P. & P. 1/-.

**TEST METER.**—7 ranges as follows: 1.5 v., 3 v., 150 v. 6 mA., 60 mA., 5,000 ohms, 25,000 ohms 2 1/2 in. dia. scale M.C. meter. Rotary selector switch. Black bakelite case, 6 x 4 1/2 x 4 1/2 fitted with removable lid, also provision for internal batts., ranges can be easily extended. Bargain price 30/-, plus 1/6 post.

**VALVES.**—B7G base. IT4, 1S5, 1R5, 1S4, 3S4, 3V4, 7/6 ea., or 4 for 27/6. Most of the 1.4 v. B7G range available at 8/6 ea.

**HEADPHONES.**—Low resistance type CLR No. 3, 9/6. DLR No. 2, 13/6. High resistance and the most sensitive of all DHR, No. 5B, 18/6 per pair, P. & P. 1/- pair.

**FISK SOLARISCOPEs.**—Complete with charts. Give World time, light and darkness paths. Invaluable to the DX man. List 2/-, our price 7/6, post free.

**PANL Home Crackle.**—Black, Brown or Green, 3/- tin. P. & P. 8d.

**FOR THE NEW MOBILE.**—12 v. Miniature Rotary Transformers. Output 360/310 v., 30 mA., C.S. or 70 mA. I.C.A.S. Only 4 1/2 in. x 2 1/2 in. overall. Only 17/6 ea., or 30/- for 2. P. & P. 1/6.

### UNREPEATABLE VALVE OFFER

Genuine American 807's. 7/6 ea. or 4 for 25/- . Photo-multipliers. Type 931A. 35/- ea. or 2 for £3.

Postage free on all orders over £1 except where specifically stated. **PLEASE PRINT YOUR NAME AND ADDRESS.**

## G. H. YOUNG, G2AK

All callers  
110, Dale End,  
Birmingham 4 (CEN 1635)

Mail Orders to Dept. "P"  
102, Holloway Head,  
Birmingham 1 (MID 3254)

**RECEIVERS & COMPONENTS**

**ELECTROLYTICS**, capacity, voltage, size, type of mounting, price, post paid. 400, 6v, lin. x 2in., lug. 1/8; 250 + 250, 6v, lin. x 2in., lug. 1/8; 1,000 + 2,000, 6v, 1 x 3. clip. 3/6; 250, 12v, 1/2 x 1 1/2, clip. 1/9; 500, 12v, 1/2 x 1 1/2, W.E. 2/-; 10, 25v, 1/2 x 1 1/2, clip. 1/3; 25, 25v, 1/2 x 1 1/2, W.E. 1/6; 500, 50v, 1 x 3, clip. 3/6; 13, 100, 50v, 1/2 x 1 1/2, W.E. 2/3; 50 + 50, 150v, 1 1/2 x 2, clip. 2/9; 40 + 40, 275v, 1 1/2 x 2, clip. 3/3; 100 + 275/350v, 1 1/2 x 3, clip. 3/3; 24, 275v, 1 1/2 x 2, clip. 3/-; 60 + 250, 275/350v, 1 1/2 x 4 1/2, clip. 6/3; 32 + 32, 275v, 1 x 3, W.E. 3/3; 24, 275v, 1/2 x 2, clip. 3/-; 16 + 16 + 8, 350/425, lug. 4/3; 32 + 32, 350/425v, clip. 1 1/2 x 2, 4/3; 16 + 16, 350/425v, clip. 1 1/2 x 2, clip. 3/9; 8 + 8, 350v, 1 x 2, clip. 3/3; 16 + 32, 350v, 1 x 2, clip. 3/9; 8, 450v, 1 x 2, clip. 1/9; 15 + 15, 450v + 20, 25v, 1 x 3, lug. 4/3; 64 + 120, 275v, 1 x 4 1/2, clip. 5/6; 20 + 10, 450v, 1 x 3, clip. 4/6; 16 + 16, 450v, 1 x 2 1/2, clip. 4/3; 100 + 200, 350/425v, 2 x 4 1/2, clip. 6/9; 8, 500v, 1 1/2 x 2 1/2, clip. 2/6; 8 + 8, 500v, 1 1/2 x 2, clip. 4/-; all All Cans. some with sleeves. all voltages, w.g.k., surge where marked: new stock, guaranteed. Television Chassis, cadmium plated, steel, size 14 x 13 x 2 1/2in., complete with 13 valveholders (9-B9A Pax, 1-B9A Cer., 2-B7C Cer., 1-Int. Oct. Amp.), 20 various tag strips, cut away for metal rec. line trans., etc. 9/11 each, post paid; front and rear tube mounts to fit above chassis, 3/- pair, post paid. P.M. focus Magnets, wide angle, tetrode tube, fully adjustable, 12/-, post paid. Scanning Coils, wide angle, with mounting lugs, 19/6, post paid. Line Trans. to match these coils, gives 12Kv. E.H.T., complete with width and line linearity coils, 19/6, post paid. Mains Trans. PRI. 0-210-240 SEC. 250-0-250v, 8ma, 6.3v. 2.5a. 6.3v. 0.6a. 12/-. **RADIO CLEARANCE LIMITED**, 27, Tottenham Court Road, London, W.1. (Telephone: Museum 9188.)

**MAKING YOUR OWN?** Telescopes, Enlargers, Binoculars, Microscopes, Projectors, or, in fact, anything that needs lenses. Then get our booklets, "How to use Ex-Gov. Lenses & Prisms," Nos. 1 & 2, price 2/6 each; also our stereo book, "3-D Without Viewers," price 7/6. Comprehensive lists of lenses, optical, radio and scientific gear, free for s.a.e. **H. W. ENGLISH**, Ryleigh Road, Hutton, Brentwood, Essex.

**LOUDSPEAKERS** repaired promptly. **MODEL LOUDSPEAKER SERVICE**, Bullington Rd., Oxford.

**AMERICAN RADIO** Plans and Devices. Now available. Hundreds of new and startling devices you can make. Only designs of this type available in UK. Receivers, walkie talkies, amplifiers, recorders, magic eye alarms, etc., etc. Full lists, data, illustrations free of stamp. Send to-day—A.P.S. (PW), Sedgford, King's Lynn.

**OSMOR** for really efficient Coils. Coilpacks and all Radio Components as specified for many "Practical Wireless" circuits. See advert. on page 658 for free circuits offer or send 5d. (stamps) to **OSMOR RADIO PRODUCTS LTD.** (Dept. FC12), 418, Brighton Road, South Croydon. (Tel.: Croydon 5148/9.)

**MIDDLESBROUGH**. Largest stocks on N-East coast. Radio/TV components. FM Kits, Grams, Cabinets, Tape Decks, Leak Amplifiers, Valves, etc. Callers only. **PALMERS**, 106, Newport Road. (Phone: 3096.)

**R.F. UNITS**, Types 25 at 27/6, 25 at 12/6, 24 at 11/-; brand new with valves; post 2/6. **E.W.S. CO.**, 69, Church Road, Moseley, Birmingham.

**RATES**: 5/6 per line or part thereof, average five words to line, minimum 2 lines. Box No. 3/- extra. Advertisements must be prepaid and addressed to **Advertisement Manager, "Practical Wireless," Tower House, Southampton St., Strand, London, W.C.2.**

**RADIO UNLIMITED** offer: Teletron Band 3 Coilsets, 15/-; c/plete Kit, incl. coils, valves, chassis, etc. 50/-, with p/pack. 67/6; Cleveland Converter from stock, £7/10/-; Band 3 Loft Aerials, 19/-; Dual, 25/-; Amplifiers, AC or AC/DC, this month only; Kit, incl. valves, 40/6, wired 59/6; Mullard 5-10, exact to spec., Kit, incl. valves, £10, wired £11/5/-; G/mans 5in. P.M., 17/6; Plessey 12in. P.M., 31/-; New bargain valve list. Stamp, please. **RADIO UNLIMITED**, Elm Road, London, E.17 (KEY 4813); also at 50, Hoe Street, E.17 (LAR 6377).

**ALUMINIUM CHASSIS** made to your requirements, 16 & 18 gauge; any quantity, large or small. We will be pleased to quote. **MACHINE CONTACTS**, Building 336, Hurn Airport, Christchurch, Hants.

**SERVICE SHEETS**, TV and Radio, over 2,000 models, sale or hire; Valves and Components; S.A.E. with enquiries. **W. J. GILBERT**, 24, Prithville Gardens, London, W.12.

**HRO RACK MOUNTING**; Collins TCS-10, 25 watt Trans/Receiver, mobile, Avo Testmeter; Taylor 60-tiger Generator; Taylor 45A Valve Tester; Morse Teacher with tapes; 1132A and 1481 Receivers; Type 3 Power Unit, Condensers, Resistors, etc. Low price to clear surplus gear. List free. **THE ELECTRIC METER COMPANY**, 123, Hele Road, Torquay.

**F.M. HI-FI**. New A2 Receiver, £8. **BEL**, Marlborough Yard, N.19. (ARC 5078.)

**AUTUMN CLEARANCE SALE**. Bargains for everyone! Stock Parcels value 9/10 times at 25/- and 50/-, post free. List Examples: Z17, 5/8; N77, 6/-; 0.1/350v\* Metal pack, etc. 7/6 doz. Stamp for list. **MELSON RADIO**, 315, Ewell Rd., Tolworth, Surrey.

**WALNUT** Radiogram Cabinets of distinction; stamp details. **R. SHAW**, 69, Fairlop Rd., E.11.

**REAL BARGAINS**: T.R.F. S.W. recon. for all bands, set, spread, etc., excel.; Tape Rec. Amp., new, unused, in case, half orig. price; M.W. Tuner and 8 w. pp. Amp., all excel. cond., very lowest prices. S.A.E. full details. Box No. 259, c/o **PRACTICAL WIRELESS**.

**NEW MULTIMETERS** 100 Avo Model 8, £18/5/-; 200 Taylor 88A, £12/2/6. Apply **JOHN LIONNET & COMPANY**, 62/63, Queen Street, London, E.C.4. (City 7167.)

**2-GANG CONDENSERS**, 1/9, std. size .0005, surplus, guaranteed, post 9d. Condensers, 2/6 per 100, new, mixed; a good standby for any amateur, post 9d. **DUKE & CO.**, 621, Romford Road, Manor Park, E.12.

**FOR SALE**

**SALE, COPIES P.W.**, Jan. 48 to Dec. 54 and P.T., Aug. 50 to Sept. 52, 16, Coniston Rd., Tettenhall.

**THE HIWAYMAN**. A new super Portable Radio for the home constructor: all-dry 4-valve superhet with Ferrite rod aerial; easy wiring diagrams and instructions, 1/6 (post 3d.). **RADIO EXPERIMENTAL PRODUCTS LTD.**, 33, Much Park St., Coventry.

**SITUATIONS VACANT**

The engagement of persons answering these advertisements must be made through a Local Office of the Ministry of Labour or a Scheduled Employment Agency if the applicant is a man aged 18-64, inclusive, or a woman aged 18-59, inclusive, unless he or she, or the employment, is exempt from the provisions of the Notification of Vacancies Order, 1952.

**REQUIRED** to fill immediate vacancies—Radar Mechanics with experience of Army, Mark 3 employment as Testers. **AIRTECH LIMITED**, Aylesbury & Thame Airport, Haddenham, Bucks. (Telephone: Aylesbury 1163.)

**RADIO INSPECTOR** required to cover the overhaul and testing of modern aircraft Radio and Radar equipment. The post is both permanent and pensionable. Free transport to local towns. Canteen facilities. Write fully stating experience and qualifications. **AIRTECH LIMITED**, Aylesbury & Thame Airport, Haddenham, Bucks. (Telephone: Aylesbury 1163.)

**AIRCRAFT RADIO MECHANIC REQUIRED** for maintenance and overhaul work at Croydon. Apply **MORTON ENGINEERING SERVICES**, Croydon. (Tel.: CRO 7171.)

**TESTERS REQUIRED** for Radio Production Line. Apply in writing giving details of experience and rate required to Personnel Manager, **MCMICHAEL RADIO LTD.**, Wexham Road, Slough, Bucks.

**DENCO (CLACTON) LIMITED**, due to expansion, require the services of an Engineer able to design coils and coil packs in keeping with modern technical requirements. Permanent employment and participation in pension scheme is offered to a first-class designer, 357/9, Old Road, Clacton-on-Sea, Essex.

**DENCO (CLACTON) LIMITED**, due to expansion, require the services of a Foreman skilled in setting Douglas Wave and other Coil Winders and the intelligent control of labour. Permanent and pensionable employment is offered to a man between the ages of 25 and 50 years, 357/9, Old Road, Clacton-on-Sea, Essex.

**WIRELESS STATION SUPERINTENDENT** required for the Posts and Telegraphs Department, Nigerian Federal Government, for one tour of 18 to 24 months in the first instance. Option of appointment (a) on temporary terms with salary scale (including expatriation pay) £264 rising to £1,392 a year with gratuity at the rate of £100/£150 a year, or (b) with prospect of pensionable employment with salary scale (including expatriation pay) £750 rising to £1,175 a year. Outfit allowance £60. Free passages for officer and wife. Assistance towards cost of children's passages or grant up to £150 annually for maintenance in U.K. Liberal leave on full salary. Candidates must have had wide practical experience of modern radio technique and equipment in particular V.H.F. equipment, and preferably also V.H.F. multichannel equipment. Write to the **CROWN AGENTS**, 4, Millbank, London, S.W.1. State age, name in block letters, full qualifications and experience and quote M2C/30086/PU.

**TELEVISION OFFERS CAREERS** for young men, previous experience not necessary as training is given. Apply in writing to the Personnel Officer, **PYE LTD.**, St. Andrew's Road, Cambridge.

**ELECTRONICS**—First-class openings for young men with service or amateur radio experience on work which introduces them to television technique. Apply in writing to the Personnel Officer, **PYE LTD.**, St. Andrew's Road, Cambridge.

**INSTALLATION ENGINEER** required, preferably with experience of carrying out microwave field surveys and installation. As the post will involve a considerable amount of travelling it is essential that applicants be able to drive. Apply, giving fullest details of experience, etc., and quoting ref. IEY/3, to the **PERSONNEL MANAGER, Pye Telecommunications Ltd., Ditton Works, Cambridge.**

**HEARING AID** Service Mechanics reqd. at once. Knowledge of L.F. amplification and miniature circuits essential. Good wages and conditions. Apply Box No. 260, c/o **PRACTICAL WIRELESS, of 'phone W. J. S., Welbeck 8247.**

**VALVES**

**VALVES**, new, tested and guaranteed: Matched pairs, 6V6G and EG1, 17/- per pair; EF92, 7V7, 4/6; EB91, 6AL5, 6/6; 6F12, EF91, 6AM6, 6V6G, 6V6GT, 5763, 7/6; 6BE6, 6BW6, 6K2G, 6SL7GT, 6SN7GT, 6X4, 6X5GT, 8/-; 5U4G, 12AX7, 12AT7, EBC41, UL41, UY41, X65, 8/6; PL82, PY82, 10/6; ECH42, UCH42, EP80, EP85, 11/6; ECL80, EY51, 12/6. Coax Cable, 75 ohm, 1in. stranded, 7d. yd., p. and p. 6d. R. J. COOPER, 32, South End, Croydon, Surrey (CRO 9188.)

**WANTED** Valves, EY51, ECL80, KT61, 6U4GT, PL81, 35ZA, etc., etc., prompt cash. **WM. GARVIS LTD.,** 103, North Street, Leeds, 7.

**ALL TYPES** of Valves required for cash. State quantity and condition. **RADIO FACILITIES LTD.,** 38, Chalcot Road, N.W.1. (PRImrose 9090.)

**BOOKS**

**I.P.R.E. TECHNICAL PUBLICATIONS.** 6,500 Alignment Peaks for Super-heterodynes, 5/9, post free. Data for constructing TV Aerial Strength Meter, 7/6. Sample copy. The Practical Radio Engineer, quarterly publication of the Institute, 2/-; membership and examination data, 1/-; Secretary, I.P.R.E., 20, Fairfield Rd., London, N.8.

**AMERICAN MAGAZINES**—One-year "Audio Engineering," 35/-, specimen copy, 3/3; "Popular Science," 43/-; "High Fidelity," 50/-; specimen copy 4/6. Free booklet quoting others. **WILLEN LTD.,** Dept. 40, 101, Fleet Street, London, E.C.4.

\* \* \* \* \*

**The "TYANA"**

Standard Soldering Iron



- Adjustable Bit.
- Weight approx. 4 oz.
- Heating Time 3 min.
- 40 Watt economy Consumption.
- Standard Voltage Ranges. 14/11

Replacement Elements and Bits always available.

**"DIPLOMA" HEADPHONES**



lightweight  
High Resistance (4,000 ohms). Complete with cord. 17/6

Ideal for CRYSTAL SETS

**KENROY LIMITED**  
152/297 UPPER ST., ISLINGTON, LONDON, N.1.

Telephone: Canonbury 4905-4663

**WANTED**

**PROMPT CASH** offered for your surplus brand new Valves, Loud-speakers, Components, etc. Send list and prices to **R.H.S. LTD.,** 155, Swan Arcade, Bradford, 1.

**WANTED.** Communications Wireless Sets 19 (Canadian) Mark III, T/R21 and New Zealand type ZCI. R. **GILPILLAN & CO. LTD.,** 1, High Street, Worthing. (Tel.: Worthing 8719.)

**EDUCATIONAL**

**BUILD YOUR OWN TV** and learn about its operation, maintenance and servicing. Qualified engineer-tutor available whilst you are learning and building. Free Brochure from **E.M.I. INSTITUTES, Expt. P.W.58, London, W.4.** (Associated with H.M.V.)

**A.M.I.Mech.E., A.M.Brit.I.R.E.,** City and Guilds, etc., on "no pass—no fee" terms; over 95% successes. For details of exams, and courses in all branches of engineering, building, etc., write for 144-page handbook, free. **B.I.E.T. (Dept. 242B),** 29, Wright's Lane, London, W.8.

**WIRELESS.** See the World as a Radio Officer in the Merchant Navy; short training period; low fees; scholarships, etc., available. Boarding and Day students. Stamp for prospectus. **WIRELESS COLLEGE, Colwyn Bay.**

**FIRST-CLASS  
RADIO COURSES**

**GET A CERTIFICATE!  
QUALIFY AT HOME—IN SPARE TIME**

After brief, intensely interesting study—undertaken at home in your spare time—**YOU** can secure your professional qualification. Prepare for **YOUR** share in the post-war boom in Radio. Let us show you how!

**FREE GUIDE**

The New Free Guide contains 132 pages of information of the greatest importance to those seeking such success-compelling qualifications as **A.M.Brit.I.R.E., City and Guilds Final Radio, P.M.G. Radio Amateurs, Exams., Gen. Cert. of Educ., London B.Sc. (Eng.), A.M.I.P.E., A.M.I.Mech.E., Draughtsmanship** (all branches), etc., together with particulars of our remarkable Guarantee of

**SUCCESS OR NO FEE**

Write now for your copy of this invaluable publication. It may well prove to be the turning point in your career.

**FOUNDED 1885—OVER  
150,000 SUCCESSES**

**NATIONAL INSTITUTE OF  
ENGINEERING**

(Dept. 461), 148, HOLBORN,  
LONDON, E.C.1

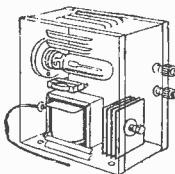

**"AUTOMAT"** Pool-proof Car Charger Kit, 6v/12v 2 amp. Selenium Rectifier, 50 watt impedance transformer or 210v/240v, ballast/indicator bulb, data-sheet, as sold by us 14 years, 31/6, handsome test case 9/6 extra, p.p. 2/-, ammeter model add 12/6. **Champion Products, 43, Uplands Way, London, N.21 Phone LAB 4137**

**FREE!** Brochure giving details of Home Study Training in Radio, Television, and all branches of Electronics. Courses for the Hobby Enthusiast or for those aiming at the **A.M.Brit.I.R.E., City and Guilds, R.T.E.B.,** and other Professional examinations. Train with the college operated by Britain's largest Electronics organisation; moderate fees. Write to **E.M.I. INSTITUTES, Dept. P.W.28, London, W.4.**

**T/V AND RADIO.**—**A.M.Brit.I.R.E., City and Guilds, R.T.E.B. Cert.,** etc., on "no pass—no fee" terms. Over 95% successes. Details of exams, and home training courses in all branches of radio and T/V; write for 144-page handbook—free. **B.I.E.T. (Dept. 242G),** 29, Wright's Lane, London, W.8.

**MERCHANT NAVY.** Train as Radio Officer. The big liners are open to you, but you must qualify for the **P.M.G. Certificate, Day, Evening and "Radiocerts" Postal Courses.** Est. 36 years. **S.A.E.** for prospectus from Director, **THE WIRELESS SCHOOL, 21, Manor Gardens, London, N.7.**

**CITY AND GUILDS** (Electrical, etc.) on "no pass—no fee" terms. Over 95% successes. For full details of modern courses in all branches of Electrical Technology, send for our 144-page handbook—free and post free. **B.I.E.T. (Dept. 242A),** 29, Wright's Lane, London, W.8.

**MERCHANT NAVY** Wireless School, Overseas House, Brooks' Bar, M/cr 16.

**THE INSTITUTE** of Practical Radio Engineers Home Study Courses are suitable coaching text for **I.P.R.E.** and other qualifying examinations. Fees are moderate. Syllabus of seven modern courses post free from **SECRETARY, I.P.R.E., 20, Fairfield Road, London, N.8.**

**WIRELESS.**—Day and Evening Class instruction for **P.M.G. Certificate of Proficiency** and **Amateur Wireless Licence.** Morse instruction only if required, also postal courses. Apply **B.S.T. LTD., 179, Clapham Rd., London, S.W.9.**

**BROOKS (Radio)**

4 Charles St., Morecambe,  
LANCASHIRE.

**Brand New Valves Guaranteed**

1R5	...	7/-	12K7	...	8/6
1T4	...	6/6	12Q7	...	8/6
1S5	...	6/6	12K8	...	9/-
354	...	7/6	25Z4	...	8/-
3V4	...	7/6	35Z4	...	8/-
5U4G	...	8/6	35L6	...	8/6
5Z4G	...	8/6	80	...	8/6
5Y3	...	7/6	VU39	...	8/6
6X5	...	6/6	UY41	...	8/-
6V6	...	7/-	UL41	...	9/6
6K7	...	5/6			
6Q7GT	...	9/-			
6K8GT	...	9/-			
757	...	8/6	EY51	...	12/6
7B7	...	8/-	EF80	...	10/-
7Y4	...	7/6	ECL80	...	11/-
7C5	...	8/6	PL81	...	11/6
7C6	...	8/6	6AM6	...	7/-
			6AL5	...	6/6
			6SN7	...	8/-

Add 6d. per valve p. & p.

**GOLD SPRAYED** expanded metal speaker fret: 12in. x 12in., 4/6; 12in. x 9in., 3/6; 8in. x 6in., 1/6. Special sizes up to 24in. x 24in. at 1/4. per sq. inch. Add 1/- towards p. & p.

### SOUTHERN RADIO'S WIRELESS BARGAINS

**TRANSRECEIVERS.** Type "38" (Walkie-Talkie). Complete with 5 Valves. In Metal Carrying Case. Ready for use. Less external attachments, 30/- per set. **ATTACHMENTS** for use with "38" **TRANSRECEIVER**: HEADPHONES, 15/6; THROAT MICROPHONE with Lead & Plug, 4/6; JUNCTION BOX, 2/6; AERIAL, 2/6; SPECIAL OFFER of used "38" **TRANSRECEIVERS** less valves but complete with ALL COMPONENTS. Excellent for SPARES, 11/6 per set. P. & P. 2/-.

**TRANSRECEIVERS.** Type "18" Mark III. TWO UNITS (Receiver & Sender) contained in Metal Case. Complete with Six Valves, Microammeter, etc. LESS EXTERNAL ATTACHMENTS, £4/10/-.

**RECEIVERS.** Type "109". 8-Valve S.W. Receiver with VIBRATOR PACK for 6 Volts. Built-in Speaker, METAL CASE, £5.

**BOMBSIGHT COMPUTERS.** Ex-R.A.F. BRAND NEW. A Wealth of Components. GYRO MOTORS, REV. COUNTERS, GEAR WHEELS, etc., etc. Ideal for Model Makers, Experimenters, etc., £3.

**LUFBRA HOLE CUTTERS.** Adjustable 1/2 in. to 3/4 in. For Metal, Wood, Plastic, etc., 6/6.

**RESISTANCES.** 100 ASSORTED USEFUL VALUES. Wire Ended, 12/6 per 100.

**CONDENSERS.** 100 ASSORTED. Mica, Metal Tubular, etc., 15/- per 100.

**PLASTIC CASES.** 1 1/4 in. x 1 1/2 in. Transparent. Ideal for Maps. Display, etc., 3/6.

**STAR IDENTIFIERS.** Type I A-N. Covers both Hemispheres. In Case, 5/6.

**CONTACTOR TIME SWITCHES.** In Sound-proof Case. Clickwork Movement. 2 Impulses per sec. Thermostatic Control, 11/6.

**REMOTE CONTACTORS** for use with above, 7/6.

**MORSE PRACTICE SET** with Buzzer on Base, 6/9. Complete with Battery, 9/6. **MORSE TAPPERS**, Std. 3/6; Midget, 2/9.

**METERS & AIRCRAFT INSTRUMENTS.** Only need Adjustment or with broken Cases. TWELVE INSTRUMENTS, including 3 brand new Aircraft Instruments. 35/- for 12.

**CRYSTAL MONITORS.** Type 2. New in Transit Case. Less Valves, 8/-.

Postage or Carriage extra. Full List of RADIO BOOKS, 2/6d.

### SOUTHERN RADIO SUPPLY LTD.,

11, LITTLE NEWPORT ST., LONDON, W.C.2. GERrard 6653

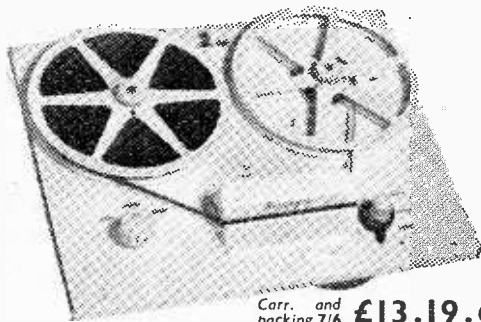

Carr. and packing 7/6 £13.19.6

# Burgoyne

## TWO-SPEED TAPE DECK 3 3/4" & 7 1/2"/sec.

Here is the heart of your Tape Recorder. If you are building or modernising your own equipment you MUST have the latest BURGUYNE Tape Deck giving 2 speeds designed for building into complete recorders.

### EASY H.P. TECHNICAL DATA

**42/- deposit and 12 mthly. payments of 23/1; or any period up to 18 months.** ★ 2 HOURS' PLAYING TIME. ★ Fully automatic speed change. ★ Instantaneous and positive braking. ★ Powered by 3 high-grade motors. ★ Twin track heads. ★ Minimum wow and flutter. ★ Frequency range 50/10,000 c/s at 7 1/2 in./sec. ★ 200/250 v. A.C. mains.

Now exclusively for **NOW IMMEDIATE DELIVERY**

**E. & G. MAIL ORDER SUPPLY CO.** The Radio Centre 33, Tottenham Court Road, London, W.1. MUSEum 6667

### F M and HI-FI Components

DENCO F.M. TUNER circuits 1s. 6d.  
RADIO CONST'R. F.M. " 2s. 0d.  
MULLARD AMPLIFIER " 2s. 6d.  
OSRAM 912 AMPLIFIER " 3s. 6d.

Separate price lists available on request to

**J. T. FILMER MAYPOLE ESTATE, BEXLEY, KENT.**

Tel. Bexleyheath 7267.

### 1-Finger Pianists

Build your own electronic keyboard and play everything! Send for free leaflet. Cuitar, cello, flute and trumpet are all easy. Write now...

**C & S, 10 Duke St., Darlington, Co. Durham**

### TELEKIT SUPPLY

MAIL ORDER DEPT.  
Chantry Lane, Bromley, Kent.  
Please mention P.W. and enclose 6d. postage.

#### VALUES GUARANTEED

O7A	4/-	6BW8	6/6	EF50	5/-
ILN5 (soiled)	6CH6	6/6	W77	5/-	
IS5	3/-	6J5	5/-	1R24	35/-
IU5	6/-	6V6	7/-	6AK6	6/6
3763	6/-	6X4	6/6	6AQ5	8/-
6A8	8/-	6X5	7/-	6U5	6/-
6AL5	6/-	7DS	7/6	12AT6	7/6
6AT6	7/6	7D8	7/6	12D1	7/-
6B3	6/-	7H7	6/-	50C5	7/-
6B6	6/-	9D2	6/-	TT11	6/-
6BA6	6/-	12BE6	6/6	12BH7	7/-
6BE6	6/-	12A6 1299	6/6	6BH6	6/-
6BB7	8/6	(soiled)	5/-	6KT5	5/-
6BS7	7/-	15D2	6/-	7B6	9/-

COMPONENTS FOR F.M. RADIO, T.V. RADIO CONTROL, BAND III, ETC., AVAILABLE AT

104, HIGH ST., BECKENHAM, KENT  
BEC 3729

### RADIO AND TELEVISION COMPONENTS

All parts in stock for:  
**Viewmaster, Soundmaster, Telex, etc.**  
Easy Terms available.  
21d. stamp only for Catalogue.

**JAMES H. MARTIN & CO.,**  
FINSTHWAITE, NEWBY BRIDGE,  
ULVERSTON, LANCs.

### ANNAKIN'S BARGAINS

Control No. 223.—Has 2-4P2W rotaries, 2 knobs, 1-DPST toggle, 1-4W jack, 3-3W jacks, 2/6 ea., 1/6 post. Carbon Mikes, breast-plate type, easy alter to hand mikes, 5/- ea., 9d. post. Small Neons, E. S. base, no resistor, 1/6 ea., 21d. post. Two Low-voltage Toggles in metal box, 1/- ea., 6d. post. Mikes (magnetic), small (small chips on bakelite rim), 1/- each., 4d. post. One-valve Amplifier Unit, P.P. input, transf., etc. (10U/9150), less 220B valve, 2/- ea., 1/3 post. C.W.O. only, 25, ASHFIELD PLACE, OTLEY, YORKS

### Solder with



NOW AVAILABLE WITH THE REMARKABLE NEW



Details of full range now comprising 20 models in folder No. S.P.10 sent on request.

Sole Manufacturers and Distributors:

**LIGHT SOLDERING DEVELOPMENTS LTD.,**  
106, GEORGE STREET, CROYDON, SURREY.  
Tel. CROYdon 8589

The soldering bit which lasts indefinitely, does not become pitted or lose its face and requires no reshaping, filing or maintenance. Fired bit models and replaceable bits available in all sizes.

- NO TRANSFORMER NECESSARY.
- FOR MAINS OR LOW VOLTAGES.

Rapid Heating—Extreme lightness—Twenty models—Bit sizes, 1 1/8 in., 3/16 in., 1/4 in., 5/16 in., 3/8 in.—Prices from 19/6. All voltages from 67 v. to 230/50 v. (State voltage when ordering.)

### F.M. KITS

We can supply complete kits and separate components for all the popular Home Constructor F.M. Tuner Units.

FULLY DETAILED LISTS FREE

H.P. Facilities

### WATTS RADIO,

8, Apple Market, Kingston-on-Thames, Surrey.

Telephone : KINGston 4099.



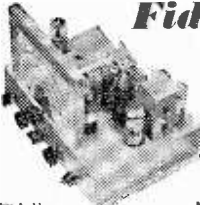

**Fidelia**  
HAND  
BUILT  
RADIO  
UNITS

THE  
FIDELIA  
MAJOR 10

Fidelia AM/FM models give reception of V.H.F. high quality transmissions plus normal wavebands. Major AM FM 12 valves. £42. De-Luxe AM/FM 11 valves. £33. F.M. Tuner. £17.9. Data sheets. 2. Electro Acoustic Developments. 2. Amhurst Road, Tinscombe Cliffs, Scssex.

**STAN WILLETTS**

43, Spon Lane, West Brom'wich, Staffs.

Tel.: WES 2392  
B.S.R. "MONARCH" 3-SPEED MIXER autochange, brand new, boxed. £7.10/-, callers only  
PRE-AMPLIFIER (PACKARD-BELL) brand new with valves 6SL7, 2BD1 and circuit 12/3. P. & P. 1/-  
"TRIPLE T" 1 mA motor rectifiers brand new with circuit. 5/6. P. & P. 4d.  
GERMANIUM CRYSTAL DIODES, G.E.C., 1/- each; 9/6 doz. P. & P. 3d.  
"VALVES" brand new guaranteed. PCL33, 10F1, 9/6; 6J6, EL32, 5/-; 6U4C, CSN7, 6SL7, 6K8G, PEN46, 7/6; 6V6GT, 6/-; ATP4, 3/6; 723A/B, 45/-; 9D2, 15D2, 3/6; 8D2, 4D1, 1/9; SP61, 2/-; 12BE6, 5/6; RM2, 3/9; RM3, 5/-; RM4, 1/-; Set of 4 battery valves, 28/3; IT4, 15S, IR5, 384 or DL84, P. & P. 6d.  
CONDENSERS brand new, 8 mfd, 450 volts, 1/9; 32x32 mfd, 450 volts, 4/9; 24 mfd., 2/-; 100 mfd, 450 volts, 3/9; 64-120 mfd, 275 volts 4/9. P. & P. 6d.  
WANTED: VALVES, BEST PRICE PAID.

**H.A.C. SHORT WAVE EQUIPMENT**

Noted for over 18 years for . . .  
S.W. Receivers and Kits of Quality.

Improved designs with Denco coils:  
One-Valve Kit, Model "C" Price, 25/-  
Two " " " " " " " " 50/-

All kits complete with all components, accessories, and full instructions. Before ordering call and inspect a demonstration receiver, or send stamped, addressed envelope for descriptive catalogue.

"H.A.C." SHORT-WAVE PRODUCTS  
(Dept. TH), 11, Old Bond Street, London, W.1.

**CASCADE TYPE**

**T/V PRE-AMPS**

NOW PROVING VERY POPULAR  
Manufactured specially to suit fringe and ultra-fringe conditions. In use 140 miles north of Kirk o' Shotts (check our position) and in many other distant locations and difficult reception areas. Complete in crinkled steel case with built-in power-pack 275-250 A.C., £5.5-. Also available, less power-pack, for inclusion in .15 or .3 amp heater chains.

**£2.17.6**

State heater current and channel used, or send 6d. stamp for illustrated details and some interesting fringe data.

**ELECTRO-ACOUSTIC LABS.,**  
TAIN-ROSS-SHIRE-SCOTLAND

**FREE CATALOGUE**

New, guaranteed components by the leading makers. 58 pages illustrated on fine art paper. Over 2,000 items listed with over 100 photographic illustrations. Special features for service work. Orders dealt with day received.

**SOUTHERN RADIO & ELECTRICAL SUPPLIES**  
SORAD WORKS, REDLYNCH SALISBURY

Telephone : Downton 207

**CABINETS**

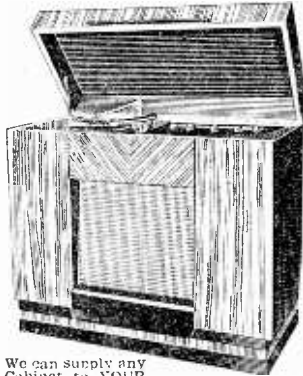

We can supply any Cabinet to YOUR OWN SPECIFICATION. The one illustrated can be obtained in Walnut, Oak, or Mahogany for £19.15.0 or as a COMPLETE RADIOGRAM. Send 1/- for complete Catalogue of Cabinets, Chassis, Autochangers and Speakers (refunded on receipt of order).

**Lewis Radio Co.,**

120 Green Lanes Palmers Green, London, N.13

**A SIX RANGE RES/CAP BRIDGE AT 35/- ONLY**

Checks all types resistors and condensers. Complete instructions and diagrams for easy assembly. Ready calibrated for immediate use.

**P.K. UTILITIES**  
6, Raleigh Street, Nottingham

**TELETRON SUPER INDUCTOR COILS**

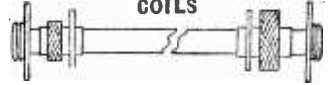

**FERRITE ROD AERIALS**

Wound on high permeability Ferroxcube rod. MW.8/9. Dual wave. 12/3.

**BAND III CONVERTER COILSET.** 15/-  
Wiring diagram, circuit and constructional information 3d. (free with coilsets). Selective Crystal diode coil, Type HAX, 3/-  
For tape and quality amplifiers. Dual wave T.R.F. Coils, matched prs., 7/-  
Transistor coils, IFT's etc., available from leading stockists. Stamp for complete list and circuits.

**THE TELETRON CO. LTD.**  
266, Nightingale Road, London, N.9  
HOW 2527

**Are You Making Your Own Radio or Television ?**

We can make the cabinet for you in any shape, design or finish you require. Work executed by expert craftsmen.

Call or send drawings for quotation.

**B. KOSKIE (Dept. C)**  
72-76, Leather Lane, HOLEORN, E.C.1.

Phone : CHAncery 67911/2.

**RADIO VALVE SUPPLY**

GLAZEBURY, NR. MANCHESTER

**VALVES GUARANTEED**

EAS0	2/-	PY82	7/3	6H6GT	2/6
EBF80	10/6	SP41	3/-	6H6M	3/6
KC91	7/-	SP61	2/3	6L6GT	5/-
ECC31	5/-	11Z3	10/-	8J5M	5/-
ECL80	10/-	5Y4M	5/-	6AQ5GT	2/-
EF50	5/-	5Y4G	9/3	8L6C	9/3
EF91	6/6	5Z4G	8/-	6S4UGT	6/-
EF92	6/-	5Z4M	8/-	6SL7GT	8/-
EF81	10/-	6AC7M	6/3	6SN7GT	8/-
EY51	11/-	6AL5	6/-	6V6GT	7/6
EY31	7/-	6C33	8/-	6X5GT	6/6
KT3C	9/-	6C1	7/3	7D3	2/6
KT61	9/-	6F3	8/-	8J7	7/-
PT31	9/8	6F33	9/-	953	3/8
PY81	10/-	6AQ3	1/3	9011	5/-

Prompt Dispatch. Please enclose 6d. postage.

**KENDALL & MOUSLEY LTD.**

(Technical Book Dept.)

OFFER THE FOLLOWING

**BOOKS**

Practical T.V. Aerial Manual for Bands I and III (R. Laidlaw).  
T.V. Pre-amplifiers Bands I and III (B. L. Morley).  
Television Circuit Refinements (C. H. Banthorpe).  
Unit Constructed T.V. Receivers (E. N. Bradley).  
We can supply all parts for the Single-Ended Direct Couple Amplifier.  
The "Univertor" Converter for Band III T.V. (Anderson and Torrance).  
WE CAN SUPPLY ANY GOOD COMPONENTS, VALVES, TRANSFORMERS, ETC. AS WELL AS 1". RESISTORS AND CONDENSERS From Stock.  
18, MELVILLE ROAD, EDGBASTON, BIRMINGHAM 16

**HANNEY of BATH offers:—****COMPONENTS FOR F.M.**

DENCO 'MAXI-Q' F.M. Feeder Unit. Instructors' Manual, 1/9. P.F. : Chassis 7/6 : Coliset 11/9 : ten 7 Mc/s I.F.s 6/- each : Ratio discrim. trans. R.D.T.1 12/6. Scale and drive complete for assembly 9/-.

MULLARD F.M. TUNER COILS (Deneco). 510/IFF 2/6 each : 510/AE 4/6 : 510/RFC 2/- : 510/RF 2/6 : 510/OSC. 4/6 : 510/IFT1 7/6 : 510/IFT2 7/6 : 510/RDT12/6 : All Chassis punched with all holes. 12/-.

OSRAM F.M. TUNER COMPONENTS (Deneco). O/T1 2/9 : OL1 2/6 : OL2 2/- : I.F.s 6/- each : O/T2 with crystals 19/6. Chassis complete with printed dial, front panel and drive mechanism 37/6. OSMOR F.M. COILS. QAFM 7/- : QRFM 5/- : QOPM 7/6 : QICD with crystals 25/- : QIFM 7/-.

OSRAM 912 Erie resistor-pot kit with ceramic tube resistors. very highly recommended. 29/6 : Lab. resistor kit, 32/4 : T.C.C. condensers. 55/- . PARTRIDGE Components, with loose lead terminations. Mains trans. 44/- : Smoothing Choke, 29/6 : Output trans. 78/9. Price includes Partridge carriage/packing charge.

W.B. OUTPUT TRANS. 32/- : W.B. smoothing choke. 18/9.

DENCO 16 s.w.g. All-chassis. 14/6 : Bronze finished printed panel. 6/6 : 912 Plus printed front panel. 7/6 : 912 Plus pre-amp chassis. 6/-.

MULLARD 5 VALVE 10 WATT AMPLIFIER. T.C.C. Condensers. 45/- : Erie resistor-pot kit. 37/6 : Elstone Mains trans. 36/- : Elstone Output trans. 45/- (both types) : Denco chassis. 14/6 : Printed bronze panel 14in. x 5in. 6/6. Small parts as per our list. Matched valves available for both the above designs.

HIGH FIDELITY SPEAKERS. W.B. HF810, 60/6 : W.B. HF912, 87/3 : W.B. HF1012 (3, 7.5 and 15 ohm coil), 97/6. G.E.C. type FR metal cone. 28 15/- . Goodmans "Orlin 111," 29/15/-.

COILPACKS. DENCO. CP 4/L and CP 4/M, 33/4 : CP 3/370 p.f. and CP 3/500 p.f. 42/8. OSMOR "Q" HO, 48/- : LM, 40/- : Batt., 50/- : TRF, 40/- : HF stage for HO pack, 20/- . We stock COILS by Weymouth, Osmor, Wearite, Denco, R.E.P.

WIDE ANGLE COMPONENTS. ALLEN. Teleking Chassis, 50/- : Coilsets (TK and Super-Visor), 44/6 : LO.308, 40/- : FO.305, 21/- : DC.300c, 39/6 : FC302, 31/- : GL.16 and 18, 7/6 each : SC.312, 21/- : AT.310, 30/- : OP.117, 9/- : BT.314, 15/- : DENCO Chassis Magnaview, 37/6 : Chassis Super-Visor, 51/6 : Coilsets Magnaview, 41/2 : WA/FCAL, 43/- : WA/FCAL, 31/- : WA/LCL and WCL, 7/6 each : WA/FMAL, 1/- : WA/LOT1, 42/- : WA/FBT1, 18/-.

HAND 3. Teletron Coilset, 15/- with circuit : Punched chassis 3/9.

Send S.A.E. for our General List. Please add 2/- postage to orders under £3 (excess refunded).

**L. F. HANNEY****77, LOWER BRISTOL ROAD, BATH**

Tel.: 3811

- T/V TECHNOLOGY
- RADIO ENGINEERING
- ELECTRONICS
- RADIO SERVICING

There's a big future in T/V and Radio. Act now ! Increase your knowledge. Back up experience with a sound theoretical background. I.C.S. offer courses of instruction in—

T/V TECHNOLOGY

T/V SERVICING

ADVANCED SHORT-WAVE RADIO

RADIO ENGINEERING

RADIO SERVICE ENGINEERING

RADAR

ELECTRONICS

FREQUENCY MODULATION

I.C.S. will also coach you for the following

examinations:—

B.I.R.E.; P.M.G. Certificate for Wireless

Operators; Radio Servicing Certificate

(R.T.E.B.); C. &amp; G. Telecommunications, etc.,

etc.

**DON'T DELAY—WRITE TO-DAY** for free descriptive booklet, stating which subject or examination interests you. Fees include all books needed. Examination students coached until successful. Reduced terms for H.M. Forces.

Dept. 170D, I.C.S., 71, Kingsway, W.C.2.

**INTERNATIONAL CORRESPONDENCE SCHOOLS.**

(Dept. 170D), International Buildings, Kingsway, London, W.C.2.

Please send booklet on.....

Name..... Age.....

(Block letters, please)

Address.....

**RADIO/RADIOGRAM CHASSIS****BUILT TO****HIGHEST TECHNICAL STANDARDS****NEW RANGE OF MODELS WITH LATEST FEATURES****FERRITE ROD AERIAL****MINIATURE (BVA) VALVES, STEEL CHASSIS****3 WAVEBANDS, A.C. MAINS, 200/250 VOLTS****ASSEMBLED AND READY FOR USE. FULLY GUARANTEED**

Model F.3. 5 Valves chassis, 4 watt output. Wide range tone control.

Model F.3. Push-Pull chassis. 7 valves, 6 watt output, separate bass and treble controls.

Size 12" x 7" x 7" high.

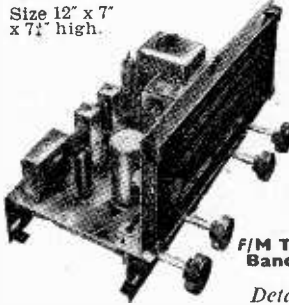

Negative feedback applied from output transformer secondary. Gram switching on wave-change switch. Plug-in connections for pick-up, speaker, gram motor.

**Manufacturers of Tape Recorders, Amplifiers for Tape Recorders, Crystal Receivers as Tuner Units, F/M Tuners (Self powered) Band III T.V. Converters.**

*Detailed list and dimensions***DIRECT FROM THE MANUFACTURER****THE DULCI CO. LTD.**

99 VILLIERS ROAD, LONDON, N.W.2

Telephone: WILlesden 6878

**We're Happy and Proud to report . . . .**

THE GOLDRING VARIABLE RELUCTANCE CARTRIDGE NO. 500 WAS RATED

**"BEST CARTRIDGE"****"BEST BUY"**

Tested against 25 competitive cartridges including those of variable reluctance, magnetic, ceramic, moving coil, crystal and capacitance types.

By a leading consumer product testing organization in the U.S.A.

The **Goldring Manufacturing Co. (Great Britain) Ltd.**  
49-51A, DE BEAUVOIR ROAD, LONDON, N.1  
Telephone: CLIssold 3434

## Practical Wireless BLUEPRINT SERVICE

### PRACTICAL WIRELESS

*No. of  
Blueprint*

#### CRYSTAL SETS

1/6d. each	
1937 Crystal Receiver ...	PW71*
The "Junior" Crystal Set ... ..	PW94*
2s. each	
Dual-Wave "Crystal Diode" ... ..	PW95*

#### STRAIGHT SETS

##### Battery Operated

One-valve : 2s. each	
The "Pyramid" One-valver (HF Pen) ...	PW93*
The Modern One-valver ... ..	PW96*
Two-valve : 2s. each.	
The Signet Two (D & LF) ... ..	PW76*

3s. each	
Modern Two-valver (two band receiver) ...	PW98*
Three-valve : 2s. each	
Summit Three (HF Pen, D, Pen) ... ..	PW37*
The "Rapide" Straight 3 (D, 2 LF (RC & Trans)) ... ..	PW82*
F. J. Camm's "Sprite" Three (HF, Pen, D, Tet) ... ..	PW87*

3s. each.	
The All-dry Three ...	PW97*
Four-valve : 2s. each.	
Fury Four Super (SG, SG, D, Pen) ... ..	PW34C*

##### Mains Operated

Two-valve : 2s. each.	
Selectone A.C. Radiogram Two (D, Pow) ...	PW19*
Three-valve : 3s. 6d. each.	
A.C. Band-Pass 3 ...	PW99*
Four-valve : 2s. each.	
A.C. Fury Four (SG, SG, D, Pen) ... ..	PW20*
A.C. Hall-Mark (HF Pen, D, Push Pull) ...	PW45*

#### SUPERHETS

Battery Sets : 2s. each.	
F. J. Camm's 2-valve Superhet ... ..	PW52*
Mains Operated : 3s. 6d. each.	
"Coronet" A.C.4 ...	PW100*
AC/DC "Coronet" Four	PW101*

*No. of  
Blueprint*

#### SHORT-WAVE SETS

##### Battery Operated

One-valve : 2s. each.	
Simple S.W. One-valver	PW88*
Two-valve : 2s. each.	
Midget Short-wave Two (D, Pen) ... ..	PW38A*
Three-valve : 2s. each.	
Experimenter's Short-wave Three (SG, D, Pow) ... ..	PW30A*
The Perfect 3 (D, 2 LF (RC and Trans)) ...	PW63*
The Band-spread S.W. Three (HF, Pen, D, (Pen), Pen) ... ..	PW68*

#### PORTABLES

1s. 6d.	
The "Mini-Four" All-dry (4-valve superhet)	*

#### MISCELLANEOUS

2s. each.	
S.W. Converter-Adapter (1 valve) ... ..	PW48A*
(2 sheets), 7s. 6d.	
The P.W. 3-speed Autogram ... ..	*
The P.W. Electronic Organ (2 sheets), 7s. 6d.	*

#### TELEVISION

The Practical Television Receiver, (3 sheets), 10/6	
The "Argus" (6in. C.R. Tube), 2/6*	
The "Super-Visor" (3 Sheets), 7/6*	
The "Simplex" ... .. 3/-*	

All the following blueprints, as well as the PRACTICAL WIRELESS numbers below 94 are pre-war designs, kept in circulation for those amateurs who wish to utilise old components which they may have in their spares box. The majority of the components for these receivers are no longer stocked by retailers.

### AMATEUR WIRELESS AND WIRELESS MAGAZINE

#### STRAIGHT SETS

##### Battery Operated

One-valve : 2s.	
B.B.C. Special One-valver ... ..	AW387*

##### Mains Operated

Two-valve : 2s. each.	
Consoelectric Two (D, Pen), A.C. ... ..	AW403

#### SPECIAL NOTE

THESE blueprints are drawn full size. The issues containing descriptions of these sets are now out of print, but an asterisk denotes that constructional details are available, free with the blueprint.

The index letters which precede the Blueprint Number indicate the periodical in which the description appears. Thus P.W. refers to PRACTICAL WIRELESS, A.W. to *Amateur Wireless*, W.M. to *Wireless Magazine*.

Send (preferably) a postal order to cover the cost of the Blueprint (stamps over 6d. unacceptable) to PRACTICAL WIRELESS, Blueprint Dept., George Newnes, Ltd., Tower House, Southampton Street, Strand, W.C.2.

*No. of  
Blueprint*

#### SHORT-WAVE SETS

##### Battery Operated

One-valve : 2s. each.	
S.W. One-valver for American ... ..	AW429*
Two-valve : 2s. each.	
Ultra-short Battery Two (SG, det Pen) ... ..	WM402*
Four-valve : 3s. each.	
A.W. Short Wave World-beater (HF Pen, D, RC, Trans) ... ..	AW436*
Standard Four-valver Short-waver (SG, D, LF, P) ... ..	WM383*

##### Mains Operated

Four-valve : 3s.	
Standard Four-valve A.C. Short-waver (SG, D, RC, Trans) ... ..	WM391*

#### MISCELLANEOUS

Enthusiast's Power Amplifier (10 Watts) (3/-)	WM387*
Listener's 5-watt A.C. Amplifier (3/-) ...	WM392*
De Luxe Concert A.C. Electrogram (2/-) ...	WM403*

#### QUERY COUPON

This coupon is available until Nov. 7th, 1955, and must accompany all Queries, sent in accord with the notice on page 713.

PRACTICAL WIRELESS, Nov., 1955.

Published on the 7th of each month by GEORGE NEWNES, LIMITED, Tower House, Southampton Street, Strand, London, W.C.2. and printed in England by W. SPEAIGHT & SONS, Exmoor Street, London, W.10. Sole Agents for Australia and New Zealand: GORDON & GOTCH (Asia), LTD, South Africa: CENTRAL NEWS AGENCY, LTD. Subscription rate including postage, for one year: Inland and Abroad 13s. 6d. (Canada 13s.). Registered at the General Post Office for the Canadian Magazine Post.

## Electrical Interference?

IF YOUR RADIO RECEPTION  
IS MARRED BY NOISE FIT AN

### EDDYSTONE

## MAINS FILTER



Cat. No. 732, specially designed for use with receivers covering short and medium wavelengths, this well screened Filter Unit is most effective in suppressing mainsborne electrical interference. Finished ripple brown and supplied complete with flexible lead and socket.

**£2 15s. 0d.**

For address of nearest stockist please write :

**STRATTON & CO. LTD.**  
ALVECHURCH ROAD, BIRMINGHAM 31

*CONSTRUCTORS build these at*

## DOWN-TO-EARTH PRICES

### PERSONAL PORTABLE RADIO 30/-

This little set was designed to give you a real personal portable radio that you can enjoy anywhere without disturbing others. Use it on camping trips, in bed, in your office, or just anywhere.  
Send 2/- for layout, Wiring diagram and Components Price List.



### 1v SHORT-WAVE RADIO

★ Covers 10-100 metres.

★ World-wide reception.

★ Low drain valve.

★ Picture diagram and instructions for beginners.

★ Assembling time 1 hr.

### 30/-



This 1 valve S.W. receiver can be built from our list of components for 30/-, including valve and 1 coil covering 20-40 metres. Provision is made to increase to 2 or 3 valves if required. All components can be purchased separately and are colour-coded so that the beginner can build this set quite easily.

Send 2/- for specification, wiring diagram, layout and price list to :—

**R.C.S. PRODUCTS (RADIO) LTD**  
11 OLIVER ROAD, LONDON, E.17. Mail order only.

## REPANCO HIGH GAIN COILS

DUAL RANGE MINIATURE CRYSTAL SET COIL, with circuit. Type DRX1, 2/6.

DUAL RANGE COIL with reaction. With 2 mains and 2 battery circuits. Type DRR2, 4/-.

MATCHED PAIR DUAL RANGE T.R.F. COILS, with reaction; with battery and mains circuits. Type DRM3 8/- pair.

STANDARD I.F. TRANSFORMERS. Type S.E. 1½in x 1in. x 2½in. Pre-aligned, 465 kc/s., 13/6 pair.

MINIATURE I.F. TRANSFORMERS. Type M.S.E. 13/16in. x 13/16in. x 1½in. Pre-aligned, 465 Kc/s., 12/6 pair.

FERRITE ROD AERIAL. Type FR1. Long and medium wave. Complete with fixing brackets, 12/6.

- ★ All coils wound on low loss formers.
- ★ Individually tested and guaranteed.
- ★ Post 3d. on all orders. ★ Trade supplied.



(Regd. Design)

Distributed by :  
**RADIO EXPERIMENTAL PRODUCTS LTD.**  
33, MUEL PARK STREET, COVENTRY  
Telephone : Coventry 62572

## Finest Soldering? Always specify ERSIN MULTICORE to be precise

Wherever precision soldering is essential, manufacturers, engineers and handymen rely on MULTICORE. There's a MULTICORE SOLDER just made for the job you have in hand. Here are some of them.

**SIZE 1 CARTON**

4 specifications for radio enthusiasts.

**5/-**



**HANDYMAN'S  
CARTON**  
Sufficient for 200 average joints.  
**6d.**

**TAPE SOLDER**

MELTS WITH A MATCH!

Real tin/lead solder containing cores of Ersin Flux. Needs no soldering iron or extra flux.

**1/-  
PER CARD**



**Bib RECORDING TAPE SPLICER**

These nickel-plated brass Splicers enable recording tape to be jointed easily and accurately so that no breaks or "clicks" occur in the recording. A comprehensive leaflet is supplied with every splicer. 18/6 each (subject).

MANUFACTURERS ARE INVITED TO

WRITE FOR DETAILS OF BULK PACKS AT BULK PRICES

## MULTICORE SOLDERS LTD.

MULTICORE WORKS, HEMEL HEMPSTEAD, HERTS (BOXMOOR 3636)