

Making a Set Analyser

PRACTICAL

WIRELESS

OCTOBER
1955
EDITOR: F. J. CAMM

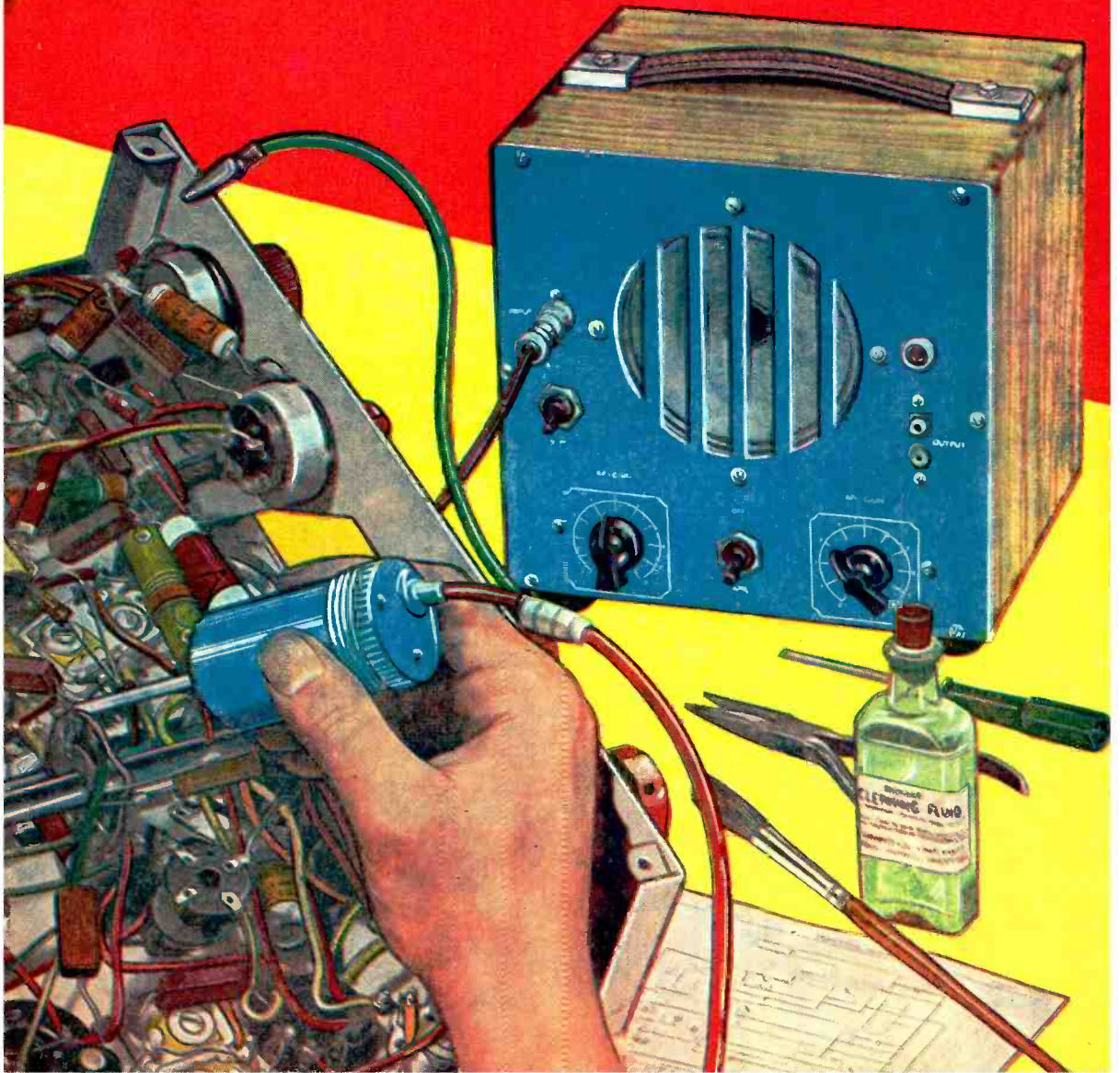

WEYRAD

COMPONENTS FOR RADIO, TELEVISION AND F.M. RECEIVERS, AM/FM COIL PACK—TYPE B.60

A complete unit covering Long-wave, Medium-wave and the FM Band. Consistent performance at V.H.F. is assured as all wiring to the valve holders and their associated components is completed and the pack is ready for installation into the receiver chassis. The B.60 has been designed for use with the 6BE6 frequency changer which provides excellent performance on all Bands. The 4-position wave-change switch has an extra wafer for the automatic selection of the appropriate detector stage output. A special 2-gang, 2-section Tuning Condenser is employed and is supplied as an additional item.

TUNING SCALE—TYPE TS.60

Printed upon glass in 3 colours. Suitable for standard drive units with horizontal pointer travel of seven inches.

AM/FM I.F. TRANSFORMERS AND RATIO DETECTOR—P21/1 AND P21/2

Designed for AM operation at 470 kc/s and FM operation at 10.7 Mc/s. The coils are wound on moulded formers and the cores are accessible from opposite sides of the screening can. It is recommended that two I.F. stages should be employed (valves 6BA6) while the detector stage uses a triple-diode-triode such as the EABC80. The ratio detector has been selected after careful tests showing very definite advantages over other arrangements. It is comparatively simple to construct and can be aligned without the aid of an FM signal generator.

10.7 Mc/s I.F. TRANSFORMERS AND RATIO DETECTOR—P20/1 AND P20/2

For FM Receivers—wound on moulded formers, core adjustment at top and bottom of transformer. Ratio detector simplifies receiver construction and alignment without sacrificing performance.

SEND STAMP FOR DETAILS AND PRICES.

WEYMOUTH RADIO MANUFACTURING CO., LTD.
CRESCENT STREET, WEYMOUTH, DORSET

BACK AT LAST

CIRCUIT TEST
L.T. TEST
H.T. TEST
M.A. TEST
VALVE TEST

PIFCO ALL-IN-ONE RADIOMETER
FOR ALL ELECTRICAL TESTS

All in One RADIOMETER AC and DC

With internal battery and multi-scale the PIFCO All-in-One Radiometer tests everything electrical, Radio and P.A. Equipments, Household appliances of all kinds, Car Lighting Systems, Bell and Teleprinter Circuits. May be used on AC or DC mains

Obtainable from your local dealer
If any difficulty, write direct to :—

29/6d.
COMPLETE

PIFCO LTD., WATLING ST., MANCHESTER 4
and at 36-37 UPPER THAMES ST., LONDON, E.C.4

Finest Soldering! Always specify **ERSIN MULTICORE to be precise**

Wherever precision soldering is essential, manufacturers, engineers and handymen rely on MULTICORE. There's a MULTICORE SOLDER just made for the job you have in hand. Here are some of them.

SIZE 1 CARTON
4 specifications for radio enthusiasts.

5/-



HANDY IN A'S CARTON
Sufficient for 200 average joints. **6d.**

TAPE SOLDER
MELTS WITH A MATCH!
Real tin/lead solder containing cores of Ersin Flux. Needs no soldering iron or extra flux.
1/- PER CARD



Bib RECORDING TAPE SPLICER
These nickel-plated brass Splicers enable recording tape to be jointed easily and accurately so that no breaks or "clicks" occur in the recording. A comprehensive leaflet is supplied with every splicer. 18/6 each (subject).

MANUFACTURERS ARE INVITED TO WRITE FOR DETAILS OF BULK PACKS AT BULK PRICES

MULTICORE SOLDERS LTD.

MULTICORE WORKS, HEMEL HEMPSTEAD, HERTS (BOXMOOR 3636)

!! HOME CONSTRUCTORS !!

You can assemble the *Stern's Fidelity* Tape Recorder for only £40 !!! IT ONLY NEEDS CONNECTING UP !!!



This 2-speed Twin Track Recorder although supplied at a Genuinely Low Price, provides absolute Fidelity Recordings, and in addition to being completely dependable has a performance at least equal to Recorders marketed at a far higher price. The actual assembly of the Recorder is simple, and only involves a few connections. The Truvox Tape Deck and the Quality Amplifier are supplied tested and ready for use, and all that is required to complete the Recorder is to connect the two together (a connection chart is supplied for this purpose) and secure them by the screws provided into the Attache Case. The items illustrated and described below form the complete equipment.

SEND S.A.E. FOR DESCRIPTIVE LEAFLET INCLUDING PRICE DETAILS & H.P. TERMS

TRUVOX TAPE DECK MODEL MK. III/TR7u

This is Truvox's new "small" design being only 1 1/4 in. x 1 3/4 in. The whole instrument is built to close engineering limits resulting in the minimum of "wow" and "Flutter" values. It will play the NEW tapes up to 1,200ft.

PRE-RECORDED TAPES and takes all standard tapes up to 1,200ft.

SCOTSBOY MAGNETIC RECORDING TAPE
Supplied complete with a 1,200ft. reel of Scotsboy Tape. In addition, the Recorder will take all standard makes of tapes.

PORTABLE ATTACHE CASE

This, as may be judged from the illustration above, is a neat, compact and attractively finished case, being covered with maroon rexine and having an ivory coloured speaker escutcheon. It contains concealed pockets to accommodate the Microphone, Mains Lead and a spare 1,200ft. reel of tape.

MODEL TRF QUALITY AMPLIFIER

This amplifier has been expressly designed to meet the requirements of enthusiasts for fidelity reproduction, and in particular to CORRECTLY operate the above TRUVOX DECK. It is supplied complete with a matched Elliptical 3 ohm P.M. Speaker. It incorporates an efficient Tone Control arrangement and has a Magic Eye Level Indicator (Operative on Record). It can also be used as a general purpose Amplifier for high quality reproduction of gramophone records direct from a Gram Unit.



MODEL MC33/1 ACOS CRYSTAL MICROPHONE
A highly sensitive Mike which accurately matches the input arrangement of the Amplifier.

It can be supplied complete and ready for use for £43. H.P. Terms available.

STERN RADIO LTD.

109 & 115, FLEET STREET, E.C.4
Tel.: CENTRAL 5812-3-4.

Osram nine·one·two

the most successful amplifier design

now...

Osram

nine·one·two PLUS

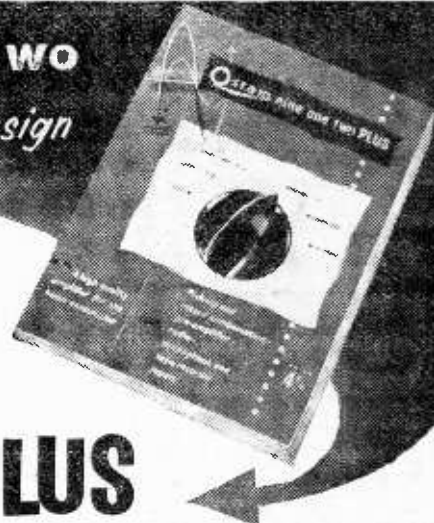

Six position fully screened Selector Switch, with or without pre-amplifier, to cater for all types of record, various types of pick-up, radio and microphone inputs.

This book gives details of how to modernise this popular Amplifier. Stage by stage wiring instructions are included for the improved '912', and there are many additional valuable features. By purchasing this book, you can read how to bring up-to-date your existing Osram '912' or obtain full details for constructing this versatile and remarkable Amplifier for High Quality Sound Reproduction. It costs 4s. 0d. from your dealer or by post 3d. extra from Osram Valve & Electronics Dept.

THE GENERAL ELECTRIC CO. LTD.; MAGNET HOUSE, KINGSWAY, LONDON. W.C.2.

PREMIER RADIO COMPANY

B. H. MORRIS & CO.. (RADIO) LTD.

OPEN TILL
6 P.M. SATURDAYS

(Dept. P.W.) 207, EDGWARE ROAD, LONDON, W.2

Telephone :
AMBASSADOR 4033
PADDINGTON 3271-2

BUILD THESE NEW PREMIER DESIGNS

3-BAND SUPERHET RECEIVER

MAY BE BUILT FOR **£7.19.6** Plus 2/6 Pk. & Carr.

Latest type Superhet Circuit using 4 valves and metal rectifiers for operation on 200/250 volts A.C. mains. Waveband coverage — short 16-50 metres, medium 180-550 metres, and long 800-2,000 metres. Valve line-up 6K8 freq. changer, 6K7, 1F, 6C7 Detector AVC and first AF, 6V8 output. The attractive cabinet to house the Receiver size 12in. long, 6 1/2in. high, 3 1/2in. deep can be supplied in either WALNUT or IVORY BAKELITE or WOOD. INSTRUCTION BOOKS 1/- each, (post wiring diagrams, also a detailed Stock



TRF RECEIVER

MAY BE BUILT FOR **£5.15.0** Plus 2/6 Pk. & Carr.

The circuit is the latest type TRF using 3 valves and Metal Rectifiers for operation on 200/250 A.C. mains. Wave band coverage is 180/550 metres on medium wave and 800/2,000 metres on 'ong wave. The dial is illuminated and the Valve line-up is 6K7 H.F. Pentode 6J7 Detector and 6V6—Output. (free) which includes Assembly and List of priced components.

4-WATT AMPLIFIER

MAY BE BUILT FOR **£4.10.0** Plus 2/6 Pk. & Carr.

Valve line-up 6SL7, 6V6 and 6X5. FOR A.C. MAINS 200/250 VOLTS. Suitable for either 3-ohm or 15-ohm Speakers. Negative feedback. Any type of pick-up may be used. Overall size 9 x 7 x 5in. Price of Amplifier complete, tested and ready for use, £5.5.0 plus 3/6 pkg. and carr.



CABINETS—PORTABLE

Model PC/1
Brown Rexine covered, 15/11.
Overall dimensions 15in. x 13 1/2in. x 5in.
Clearance under lid when closed 2 1/2in.
Model PC/2
Grey Lizard Rexine covered, 45/-.
Overall dimensions 15in. x 13in. x 6in.
Clearance under lid when closed 3in.
Model PC/3
Rexine type covering in various colours, 69/6.
Overall dimensions 16 1/2in. x 14 1/2in. x 10 1/2in.
Clearance under lid when closed 6 1/2in.
All the above Cabinets are supplied with P.A. n.e.l. Carrying Handle and Clips. Packing and Postage 2/6.
Send for details of the Premier Wide angle Television design which may be built for £80.

ALL-DRY BATTERY PORTABLE RADIO RECEIVER

MAY BE BUILT FOR **£7.8.0** Plus 2/6 Pk. & Carr.

4 miniature Valves in a Superhet Circuit covering medium and long waves. Rexine covered Cabinets 11 1/2in. x 10in. x 5 1/2in. in two contrasting colours. Wine with Grey Panel, or Blue with Grey Panel, please state choice when ordering. **THE SET MAY BE USED EVERYWHERE—home, office car or holidays.** INSTRUCTION BOOK, 1/6 (Post free) which includes Assembly and wiring diagrams, also a detailed Stock List of priced components.



DECCA MODEL 37A DUAL SPEED RECORD PLAYER Includes turn over crystal pick-up with sapphire stylus and a light-weight, plastic, spring-balanced arm. Heavy gauge pressed steel case with brown enamel finish in good quality for operation on A.C. mains 200/250 v. 50 c.p.s. Supplied complete, £6.19.6. Plus pkg. and carr. 5/-.

★SEND 2/-d. STAMP FOR OUR 1955 CATALOGUE

NEW!

THE PRACTICAL WAY of learning RADIO · TELEVISION · ELECTRONICS



Power Supply unit



2-stage receiver



3-stage T.R.F. Receiver



Special units



Complete 5 valve Superhet 3-wave band receiver suitable for A.M. or F.M. reception



Instructional lesson manuals



COMPLETE EXPERIMENTAL COURSE in RADIO ENGINEERING and SERVICING

An entirely new series of courses designed to teach Radio, Television and Electronics more quickly and thoroughly than any other method. Specially prepared sets of radio parts are supplied and with these we teach you, in your own home, the working of fundamental electronic circuits and bring you easily to the point when you can construct and service radio receivers, etc.

Whether you are a student for an examination; starting a new hobby; intent upon a career in industry; or running your own business — these Practical Courses are ideal and may be yours at very moderate cost.

With these outfits, which you receive upon enrolment and which remain your property, you are instructed how to build basic Electronic Circuits (Amplifiers, Oscillators, Power Units, etc.) leading to designing, testing and servicing of complete Radio and Television Receivers.

NEW TELEVISION COURSE including a complete set of equipment dealing with the design, construction and servicing of a high quality television receiver.

COURSES FROM 15/- PER MONTH

EMI INSTITUTES

An educational organisation serving the E.M.I. Group of Companies which include
His Master's Voice, Marconiophone, Columbia, etc

SEND COUPON FOR FREE PROSPECTUS

To E.M.I. Institutes
Dept. 32X, Grove Park Road, London, W.4
Please send me your FREE book on Practical Courses

Name _____
Address _____
October _____ IC.68



FOR VALVES—GUARANTEED NEW AND BOXED

* AC7F1	6/-	EL22	12/6	MB PEN	5/-	UT41	11/6	185	7/6	B4	6/-	6V7M	6/9	7B7	8/-	12K7	9/-	
AC7P	6/6	EL22	12/6	PCV84	12/6	UY41	10/6	171	7/6	B4C	7/-	6K8C	8/-	7Q7	8/-	12K7	9/-	
* AC6, PEN	8/6	EL22	12/6	PCV82	12/6	VP22	8/-	175	8/-	6RA6	8/-	6K8GT	9/6	7B7	8/6	12K7GT	10/6	
AT4	6/6	EL24	12/3	PCV75	8/-	VR16	4/-	220V-SS	6/9	6BR7	9/6	6L9	12/6	7Y1	8/6	12Q7GT	9/-	
DI620	7/6	EL29	8/-	PEN46	8/6	VR150	30/-	2A5	6/9	6BV6	8/6	6L6G	9/-	75	10/-	12R17	5/6	
DI14	4/-	EM64	9/-	PC181	14/6	VT22	(EJ.32)	2X2	5/-	6BV6	12/6	6Z7M	7/6	77	8/-	12R17	5/6	
* DI73M	10/-	EL39	13/6	PC182	10/-	VT35	(KT4)	3/6	5/-	6C4	9/-	6Q7G	9/6	807	8/6	12S17	9/-	
DEN	10/4	EL39	7/6	PC183	12/-	VT35	(KT4)	3/6	9/-	6C4	9/-	6Q7G	9/6	807	8/6	12S17	9/-	
EA5-4	2/-	EZ40	10/-	PM12M	10/-	VE501	(TT1)	2/6	10/-	6C6	6/6	6R7G	8/-	812	2/6	12S47	8/6	
EB4	11/-	EL11	2/-	PM22B	5/6	VT39	(MU12)	2/6	8/6	6C8	6/6	6R7GT	8/-	9002	5/6	20F4	7/6	
EB23	7/6	GZ32	2/-	PV39	7/6	VT39	(MU12)	2/6	8/6	6C10G	12/6	6R7G	8/-	9003	5/6	20F3	12/6	
BPC41	11/-	H20	5/-	PY80	9/6	VC111	3/6	42	8/-	6D3	8/-	6S17	6/6	9004	5/6	20F4	10/-	
EP50	6/6	H22	7/6	PY11	10/6	VC129A	3/-	5C4 (U52)	8/-	6D6	7/6	6S7GT	8/-	9006	6/-	20F1	11/-	
EC91	7/6	HL120	3/9	SL29	8/6	W01	10/6		8/6	6F6M	7/6	6S7	6/6	954	2/6	20F3	11/6	
EC73	7/6	HL210	6/6	SL61	3/9	W6M	10/6	LY3GT	8/6	6F8M	7/6	6S7GT	8/-	955	4/6	20F4	11/-	
EC45	6/6	HL216	7/6	SL73	3/6	W75	9/6	5Z5	9/6	6F13	13/6	6S7GT	8/-	10F13	11/6	25L6GT	8/6	
EC42	10/6	K12	5/-	TP25	9/-	W77	8/6	5Z4G	8/6	6F14	12/6	6S87	8/-	10F1	10/-	25L6GT	12/-	
* EC150	11/6	K182	10/-	TP19	9/-	W81	10/6	CA7	10/6	6F15	11/6	6S87	7/6	10F9	13/-	25Z4G	9/-	
EP8	6/6	KTC30	11/6	TP22	8/6	X78	14/-	6ASG	10/6	6G6G	6/6	6U1	14/-	101D11	11/-	25Z5	7/6	
EP36	6/6	KTC30	11/6	TP22	8/6	OZ4	6/-	6AC7	6/6	6H6	3/6	6V15	8/6	10F13	11/6	25L6GT	8/6	
EP30	6/6	KTC30	11/6	TP22	8/6	LA3	8/-	6AG5	7/6	6J6A	6/6	6V15	8/6	10F14	11/6	25L6GT	10/6	
EP41	10/-	KTC61	7/9	L401	10/-	1A7	11/6	6AK5	9/-	6J6M	6/6	6V15	15/-	12A8	6/6	32Z4GT	8/6	
																	50L6GT	8/6

AMERICAN INDICATOR UNIT TYPE BC929A

Brand new incorporating 5in. tube 3BP1, with mu-metal shield, 2-5557471 2-6H6GT, 6X4, 5X2, 6001, 9 potentiometers, 24 v. aerial switch motor, transformer, and a host of small components. The whole unit which measures only 8 1/2in. x 5 1/2in. x 12 1/2in. is brand new, enclosed in black crackle box, and can be supplied at 85/-, plus 5/- p. & p.

B.S.R. MONARCH AUTOMATIC RECORD CHANGER

These units will autochange on all three speeds, 7in., 10in. and 12in. They play MIXED 7in., 10in. and 12in. records. They have separate supplies for L.P. and 75 r.p.m., which are moved into position by a simple switch. Minimum baseboard size required 14in. x 12 1/2in., with height above 5 1/2in., and height below baseboard 2 1/2in. A bulk purchase enables us to offer these BRAND NEW UNITS at this exceptional price. These units are beautifully finished in cream enamel with cream bakelite arm. COMPLETE WITH FULL INSTRUCTIONS, 29.19.6.

ANOTHER ALPHA KIT FOR YOU TO BUILD

3 valve (6K7, 6J7, 6V6GT) plus Metal Rectifier, 2 waveband Receiver. Complete in every detail, 15/10/-. Post 2/6. Circuit Diagram, Detailed Drawings and full List of Components, 1/- each.



MAINS TRANSFORMERS 2-WAY MOUNTING TYPE

MT1	200-220-240 v.	MT2	200-220-240 v.
Primary:	250-0-250 v. 50 in. A.	Primary:	350-0-350 v. 80 mA.
Secondaries:	0-6.3 v. 4 amp. 0-5 v. 2 amp.	Secondaries:	0-6.3 v. 4 amp. 0-5 v. 2 amp.
	Both tapped at 4 v. 17 8 ea.		tapped at 4 v. 17/8 ea.

WHEN ORDERING PLEASE QUOTE "DEPT. P.W."

CHASSIS

Aluminium Undrilled with Reinforced Corners. Available in the following sizes.

6in. x 4in. x 2 1/2in.	4/6 ea.	12in. x 8in. x 2 1/2in.	8/6 ea.
8in. x 6in. x 2 1/2in.	6/3 ea.	14in. x 8in. x 2 1/2in.	9/6 ea.
10in. x 7in. x 2 1/2in.	7/3 ea.	16in. x 9in. x 2 1/2in.	12/- ea.

All are four sided—ideal for radio receivers—amplifiers—powerpacks, etc.

PENCIL RECTIFIERS

K3/25, 5/8; K3/40, 7/8; K3/47, 8/2; K3/50, 8/8; K3/60, 9/8; K3/100, 14/8.

HEATER TRANSFORMERS

250 v. Input	2 volt .5 amp.	4/6
250 v. Input	2 volt 2.0 amp.	7/9
250 v. Input	4 volt 1.5 amp.	5/-
250 v. Input	4 volt 2.0 amp.	10/-
250 v. Input	5 volt 2.0 amp.	10/-
250 v. Input	6.3 volt .5 amp.	6/-
250 v. Input	6.3 volt 1.5 amp.	9/-
250 v. Input	6.3 volt 3.0 amp.	8/6
250 v. Input	12 volt 7.5 amp.	6/-

EK GOVERNMENT AND SURPLUS CONTROLS

This popular range is suitable for all Television constructors, etc. Keep your costs down when building the "Argus" or "Simplex" receivers.

- Available 500 Ω, 600 Ω, 1,500 Ω double type, 2 K Ω, 5 K Ω, 10 K Ω, 20 K Ω.
- 25 K Ω, 50 K Ω, 200 K Ω, 500 K Ω, 1 meg. Ω, 2 meg. Ω, 5 meg. Ω double type. All 1/2 each.

LOUDSPEAKER UNITS

P. & A. 10in. unit	...	25/6 ea.
Plessey 6in. lightweight unit	...	16/6 ea.
Rola 6in. standard type	...	17/6 ea.
Electrona 6in. with transformer	...	18/- ea.
Triplex 6in. water type	...	20/- ea.
Plessey 8in. lightweight unit	...	17/6 ea.
Mains energised 8in. unit, 1,000 Ω	...	21/- ea.
Mains energised 6in. unit, 600 Ω	...	17/6 ea.
Rola 8in. unit	...	17/6 ea.
Goodmans 8in. unit	...	18/6 ea.
Plessey 12in. lightweight unit	...	37/6 ea.

TRAIN SET RESISTORS

Variable Resistors. Mounted in metal case with on/off switch. 50 Ω, 8/8 ea., post 1/-.

LOUDSPEAKER CABINETS

This attractive walnut finished cabinet is available for 6in. or 8in. speaker units. Metal speaker feet complete with back and rubber feet.

6in. type: Measures 8 1/2in. x 8 1/2in. x 4 1/2in. at base. Price 16/6 each.

8in. type: Measures 10 1/2in. x 10 1/2in. x 5 1/2in. at base. Price 20/6 each.



TERMS: Cash with order or C.O.D. Postage and Packing charges extra, as follows: Orders value 10/- add 9d.; 20/- add 1/-; 40/- add 1/6; £5 add 2/- unless otherwise stated. Minimum C.O.D. fee and postage 2/3.

MAIL ORDER ONLY



5/6 VINCES CHAMBERS VICTORIA SQUARE LEEDS.

HOME RADIO OF MITCHAM

187, LONDON ROAD, MITCHAM, SURREY. MIT. 3282.

The full range of **EDDYSTONE** short wave components in stock. Eddystone catalogue price 1/-.

BAND III TV CONVERTER

Complete kit of parts including valves, ready wound TELETRON coils, punched chassis, down to the last nut and bolt. Suitable T.R.F. or superhet receivers. PRICE £2 15s. 0d. Circuit details, 6d. post paid.

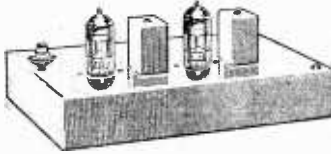

DEMONSTRATION MODEL WORKING.

FREQUENCY MODULATION TUNERS

All parts in stock and demonstration models working. Denco full constructional details, 1/6. JASON (Radio Constructor), details, 2/-. OSMOR F.M. coils, etc., in stock.

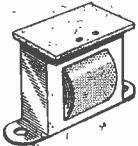
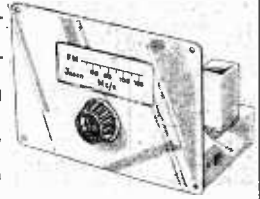

SPECIAL OFFER L.F. CHOKES

- 10H. 50 mA. 330 ohms, 2/6.
- 6H. 80 mA. 150 ohms, 2/6.
- 12H. 60 mA. 300 ohms, 3/6

All Plus 9d. Postage.

POWER UNIT. Ideal for F.M. tuners, etc. For A.C. mains. Output 250 v. 50 mA. 6.3 v. 1.5 a. Complete kit with wiring diagram, etc.

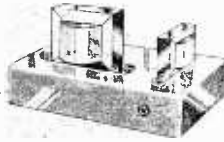

PRICE £2.

Send 6d. for latest lists.

THE "PRE-SET 3" A new really inexpensive Radio for Bedroom, Kitchen, Workshop, etc.

- ★ Fully A.C. Mains—no live chassis.
- ★ Uses EF50 (VR91) valves in T.R.F. circuit.
- ★ All parts available separately and Chassis ready punched.
- ★ 3 Pre-set M.W. stations. Easily adjusted to your choice.
- ★ Can be assembled in a few hours.

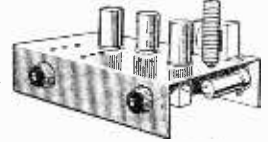

Complete Kit £3-17-6. Full details of Circuit, Point-to-Point Wiring Diagram and Parts Price List. Price 6d.

PRACTICAL TV AERIAL MANUAL For Bands I and III. PRICE 4/6.

MEDIUM WAVE DIALS High grade white ivory, 7in. x 3 3/4in. Price 2/-.

THE "BUY" OF THE YEAR

JUST LOOK WHAT THEY CONTAIN

A fine 6 valve superhet containing:— 2 EF39, 2 EF36, 1 EK32, 1 EBC33 and 2 400 IF Transformers.

AN EXCELLENT 3 VALVE TRANSMITTER

Containing:—TT1 (ideal for 2 meters), EL32, EF50. GENERATOR UNIT with smoothing, etc. Also the outfit contains relays, standard condensers, resistors, transformers and a host of useful components.

U.S.A. ELECTRO-VOICE MOVING COIL MICROPHONES

The demand for these microphones has been exceptionally heavy. We still have a few left. Send your order now to avoid disappointment. Price £2 ea., postage 1/6.

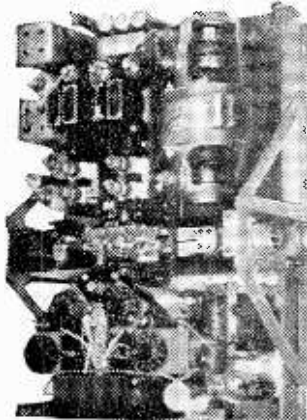

We are offering AS NEW, COMPLETE TR.1196 TRANCEIVERS, as illustrated. Outfit comprises, 6 valve Superhet, 3 Valve Transmitter, Power Unit and Relay Unit. All complete on Chassis. Present range 4-6.5 mc/s and output 2 watts. Can be easily converted to cover 1.5 mc/s-7 mc/s and power output up to 8 watts. It has a most versatile Receiver which can be easily adapted to cover any band of frequencies from medium broadcast to 30 mc/s. The Transmitter range can also be easily extended and by simply adding 200 pF condenser to tank circuit will cover 1.5 mc/s. Circuit and conversion details included with each unit. Each outfit is despatched in transit case at the amazing low price of £3, plus carriage 10/-. If despatched without Transit Case, £2/10/-, plus 8/6 carriage.

Large Quantities of Our Unused Component Bargains still available at Prices below Manufacturing Costs.

- Ceramic Variable Condensers split stator 15/15 Pf., 2/8 each. Ceramic Trimmers 22 Pf., 5/- per doz. Variable Condensers 100 Pf. ceramic insulation, 2/- each.
- Variable Condensers in screening case 50 Pf., 1/- each. Permanoid Steeving coils of approx. 1 gross yds. 1 mm. and 1.5 mm. 8/6 per coil. Ferranti M'amp. Meters Boxed 0.5 M/A flush square 2in., 9/- each.
- Wave Change Switches 2 wafer 6 pole 3-way standard 1 spindles, 1/3 each. Pots 100 K and 1 meg. 1 spindle and 3-gang each 70 K all at 1/- each. Humdinger Pots 100 ohm. miniature wire wound and Colvern do. 200 ohm 5 w., 2/- each. 100 K Miniature Pots 1in. long spindle, 1/- each. Erie Resistors 47K, 2 w. boxed in 50's and 5's. do. 33K. 2 w. 70K. 1 w. Price: 2 w., 3d.; 1 w., 2d. Wire Wound Vitreous 10 w. wire ends 500Ω, 9d. ea. Zenith 50 w. 500Ω, 2/- ea.

Add sufficient for postage to cover all items above.

WOOLLEYS. RADIO & ELECTRICAL SUPPLIES LTD.
615 BORDESLEY GREEN, BIRMINGHAM, 9. Phone: VIC 2078

LASKY'S PAGE OF MONEY-SAVING OFFERS

B.S.R. MONARCH 3-SPD. AUTO-CHANGERS



Latest 1955 model. New and Unused in Maker's Cartons. Takes 10 records of all sizes (mixed) in one loading. HGP.37 crystal turnover pick-up. Handsome cream finish. List 13 Gns.

LASKY'S PRICE £7.19.6
Carr. 3/6

SPECIAL OFFER

THE TWO

3-spd. Auto-changer and 6 valve Radiogram Chassis.

£18.19.6 Carr. Free.

Suitable Radiogram Cabinets available. You can build a complete Radiogram for **£28.12.0.**

SAVE POUNDS ON THIS FINE 6-VALVE RADIOGRAM CHASSIS Complete with valves

Famous Maker's Surplus Brand New and Complete. 6 valve, 3-wave Superhet. 13-50 m. short 200-550 m. medium. 1,000-2,000 m. long. Brand new Mullard valves: ECH42, EF41, L83, EB41, 6V6, g.t., EZ40, and finest quality components. Gram. switch, 465 Kc/s I.F., tone control, 3-colour dial. Overall size: 13 1/2 x 5 1/2 height 12 1/2 in. Aperture required for dial and controls. 11 x 3 1/2 in. Complete with valves, output trans., knobs, etc.

LASKY'S PRICE £10.19.6
Carr. & pkg., 7/6 extra.

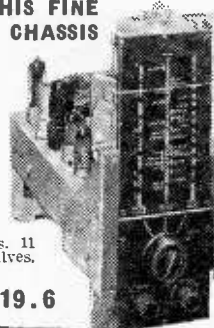

PORTABLE CASES

As illustrated Sept. advt.

Solidly made of laminated wood. Inside dim. 17 1/2 x 14 x 6 1/2 in. deep. Originally made for portable radiogram, with space (14 x 5 x 5 in.) for radio or amplifier and speaker. Motor board size 14 x 12 1/2 in. Takes any standard size gram unit. Rexine type finish in various colours. Fitted handle. 2 keys supplied.

LASKY'S PRICE, 25/-
Post. 3/6.

TELETRON BAND III CONVERTER COIL SET

For use with T.R.F. and superhet Band I receivers. Uses two Z719. Circuit, practical wiring diagram, alignments, full details, enclosed with each set.

15/-

SPECIAL PURCHASE OF PICK-UPS. Standard play. Offered at ALMOST HALF PRICE.

Goldring Bantam magnetic 25/-
Acos Crystal, type GP10. Post Free. 25/-

CYLDON 5in. SPOOLS for recording tape, each 1/6

MAGNETIC RECORDING TAPE. 1,200ft. on Cyldon Metal Spool. Kraft base. Post 1/-. **12/11**

IGRANIC JACK PLUGS, standard type, each 2/6

GERMANIUM CRYSTAL DIODES, each 1/6

AGOS CRYSTAL CARTRIDGES

Turn-over type GP29, complete with sapphire stylus. List 42/11. **LASKY'S PRICE,** Post. 1s. **21/-**
Type GP9, 78 r.p.m. Post. 1s. **17/6**

LASKY'S RADIO CONSTRUCTOR PARCELS

PARCEL No. 1

Contains everything to build a 4-valve, 3-wave superhet for 200-250 A.C. mains. Uses 6K3, 6K7, 6B7, 6V6 valves. Attractive wood cabinet, walnut veneer, or plastic cabinet. Size 12 x 6 1/2 x 5 1/2 in. deep. **CAN BE BUILT FOR £7.19.6.** Carr. and pkg. 2/6.

PARCEL No. 2

Contains everything to build a T.R.F. 3-valve set for 200-250 A.C. mains, med. and long wave. Uses 6K7G, 6B7, 6V6, and metal rectifiers. Neat plastic cabinet, walnut or ivory finish, or wood cabinet. Size 12 x 6 1/2 x 5 1/2 in. deep. **CAN BE BUILT FOR £5.10s.** Carr. and pkg. 2/6.

PARCEL No. 3

4-WATT A.C. AMPLIFIER.— Uses 1 each 8S17, 6V6 and 5Z4. All components, chassis, valves, output trans., mains trans. **LASKY'S PRICE, £4.5.0.** Post & pkg. 2/6 extra. Instruction Book, 1/- post free.

12 CHANNEL TV TUNER



Famous make. Covers Bands I and III. Complete with Valves EF90 and ECC81. Ceramic valve holders, finest quality components, precision made. Switch and fine tuning. I.F. output 20-25 and 40-50 Mc/s. Freq. coverage 60-87 Mc/s. and 175-215 Mc/s. Supplied with full details and circuit diagram. **LASKY'S PRICE, 39/6**
Post & pkg., 3/6. Knobs 2/9 extra.



SPECIAL PURCHASE RADIOGRAM CABINETS

Solidly made of 1/2 in. laminated wood, finished beautiful Walnut veneer. Panel (3in. x 16in.) for dial and controls, battle for 8in. speaker, gold finish metal grille, fully hinged lid. Overall size: 18in. deep, 18in. wide, 13in. high. Slightly soiled. **LASKY'S PRICE, 79/6**
Carriage 7/6.

FULL RANGE OF F.M. COMPONENTS

Denco, Osmor, Allen, Jason, Gortler, etc. Write for list.

EX-GOVT. ACCUMULATORS

2 volt, 10 a.h. Size: 1 1/2 in. square x 5 1/2 in. high. Made by Canadian Exide. **LASKY'S PRICE 4/6**
3 for 13/- post free.
12 for 40/- post free.

HIRE PURCHASE

Terms available on certain items. Write stating your requirements.

ELECTROSTATIC H.F. "TWEETERS"

Freq. response 3-20 Kc/s. Type LSH75. Size 3 x 3 x 1/2 in. Handles up to 7 watts, 12/6. Type L5100 Size 5 x 3 x 1/2 in. Handles up to 20 watts, 21/- post free.

3-WATT MIDGET AC/DC AMPLIFIER

PUSHPULL, VERY HIGH GAINS 4 valves: 2 U41 in push pull, 1 UCH42 and 1 UAF42. Input voltage 100/100 AC/DC. Very easily converted to 230 volts. Supplied with circuit diagram and full details. Size: 9 x 4 x 1 1/2 in. Uses 2 metal rectifiers, 1 each RM2 and RM3. Ideal for ships record players, tape recorders, home record players, baby alarms, etc., etc. Supplied complete fully assembled and wired, with 4 valves.

LASKY'S PRICE 65/-
Carr. Free.

ALUMINIUM CHASSIS

18 S.W.G., undrilled, 4 sides, reinforced corners. Depth 2 1/2 in. 6 x 4 1/2 - 12 - 8 7/8 - 16 x 10 8/9 - 8 x 6 5/8 - 14 - 9 7/16 - 12 - 3 4/9 - 10 x 7 6/8 - 16 - 9 8/8 - 12 - 6 6/8 Post 1/- per chassis extra.

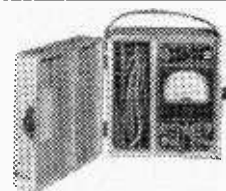

SPECIAL OFFER! MULTI-TEST METERS

1,000 ohms per volt. Basic movement 400 micro-amp. 3in. A.C. D.C. 0-5,000 v., 0-1 amp. 11 switched ranges: 100,000 ohms (using 3 v. battery supplied). Also decibel range. In polished wood carrying case (6 x 6 1/2 x 4 in. closed), with leather handle and space for test leads. Made in U.S.A. **LASKY'S PRICE, 95/-**
Post & Insur. 3/6. **TEST LEADS, 3/6 extra.** Battery, 6d. extra.

LASKY'S RADIO

LASKY'S (HARROW ROAD) LTD.,

42, TOTTENHAM COURT ROAD, W.1.
Between T.C.R. and Goudge St. Stms. MCS 2605
370, HARROW ROAD, PADDINGTON, W.9.
Opposite Paddington Hospital. CUN 1979 & 7214
Open all day Saturday, early closing Thursday

ALL MAIL ORDERS TO HARROW ROAD PLEASE



'AVO'

Registered Trade Mark.

Precision
**ELECTRICAL
TESTING
INSTRUMENTS**

A dependably accurate instrument for testing and fault location is indispensable to the amateur who builds or services his own set.

The UNIVERSAL AVOMINOR

(as illustrated) is a highly accurate moving-coil instrument, conveniently compact, for measuring A.C. and D.C. voltage, D.C. current, and also resistance; 22 ranges of readings on a 3-inch scale. Total resistance 200,000 ohms.

Size: 4 1/2 ins. x 3 1/2 ins. x 1 1/2 ins.
Net weight: 18 ozs.

Complete with leads, interchangeable prods and crocodile clips, and instruction book.

Price: £10 : 10 : 0

The D.C. AVOMINOR

Is a 2 1/2-inch moving coil meter providing 14 ranges of readings of D.C. voltage, current and resistance up to 600 volts, 120 milliamps, and 3 megohms respectively. Total resistance 100,000 ohms.

Size: 4 1/2 ins. x 3 1/2 ins. x 1 1/2 ins.
Net weight: 12 ozs.

Complete as above
Price: £5 : 5 : 0

D.C. Voltage	A.C. Voltage
0-75 millivolts	0-5 volts
0-5 " "	0-25 " "
0-25 " "	0-100 " "
0-100 " "	0-250 " "
0-250 " "	0-500 " "
0-500 " "	
D.C. Current	Resistance
0-2.5 milliamps	0-20,000 ohms
0-5 " "	0-100,000 " "
0-25 " "	0-500,000 " "
0-100 " "	0-2 megohms
0-500 " "	0-5 " "
	0-10 " "

GUARANTEE: The registered Trade Mark "Avo" is in itself a guarantee of high accuracy and superiority of design and craftsmanship. Every new Avominor is guaranteed by the Manufacturers against the remote possibility of defective materials or workmanship.

Sole Proprietors and Manufacturers —
AUTOMATIC COIL WINDER & ELECTRICAL EQUIPMENT CO., LTD.
Avocet House, 92/96, Vauxhall Bridge Rd., London S.W.1. 'Phone: VICtoria 3404-9

R.S.C. MAINS TRANSFORMERS (FULLY GUARANTEED)

Interleaved and Impregnated. Primaries 200-230-250 v. 50 c/s. Screened TOP SHROUDED DROP THROUGH

250-0-250 v. 70 mA, 6.3 v. 2.5 a. 13/9
250-0-250 v. 70 mA, 6.3 v. 2 a, 5 v. 2 a. 16/9
350-0-350 v. 80 mA, 6.3 v. 2 a, 5 v. 2 a. 18/9
250-0-250 v. 100 mA, 6.3 v. 4 a, 5 v. 3 a. 22/9
300-0-300 v. 100 mA, 6.3 v. 4 a, 5 v. 3 a. 22/9
350-0-350 v. 100 mA, 6.3 v. 4 a, 5 v. 3 a. 22/9
350-0-350 v. 100 mA, 6.3 v. 4 a, C.T. 0-4-5 v. 3 a. 23/9
350-0-350 v. 150 mA, 6.3 v. 4 a, 5 v. 3 a. 29/9
350-0-350 v. 150 mA, 6.3 v. 2 a, 6.3 v. 2 a, 5 v. 3 a. 31/8

FULLY SHROUDED UPRIGHT

250-0-250 v. 60 mA, 6.3 v. 2 a, 5 v. 2 a, Midget type 24-33in. 17/6
350-0-350 v. 70 mA, 6.3 v. 2 a, 5 v. 2 a. 19/9
250-0-250 v. 100 mA, 6.3 v. 4 v. 4 a, C.T. 0-4-5 v. 3 a. 26/9
250-0-250 v. 100 mA, 6.3 v. 6 a, 5 v. 3 a, for R1355 conversion 31/-
300-0-300 v. 100 mA, 6.3 v. 4 v. 4 a, C.T. 0-4-5 v. 3 a. 27/9
350-0-350 v. 100 mA, 6.3 v. 4 a, 5 v. 3 a. 23/9
350-0-350 v. 100 mA, 6.3 v. 4 v. 4 a, C.T. 0-4-5 v. 3 a. 27/9
350-0-350 v. 150 mA, 6.3 v. 4 a, 0-4-5 v. 3 a. 33/9
425-0-425 v. 200 mA, 6.3 v. 4 a, C.T. 6.3 v. 4 a, C.T. 5 v. 3 a. Suitable Williamson Amplifier, etc. 49/9
450-0-450 v. 250 mA, 6.3 v. 6 a, 6.3 v. 6 a, 5 v. 3 a. 69/9

E.H.T. TRANSFORMERS

2,500 v. 5 mA, 2-0-2 v. 1.1 a, 2-0-2 v. 1.1 a for VCR97, VCR517, etc. 36/6

ELIMINATOR TRANSFORMERS

Primaries 200-250 v. 50 c/s, 120 v. 40 mA 130 v. 50 mA, 6 v. 3 a. 14/9

MIDGET MAINS TRANSFORMER. Manufacturer's Surplus. Primary 220/240 v. Secs. 230-0-230 v. 60 mA, 6.3 v. 2 a. Only 11/9.

FILAMENT TRANSFORMERS

All with 200-250 v. 50 c/s primaries 6.3 v. 1.5 a, 5/9; 6.3 v. 2 a, 7/8; 0-4-6.3 v. 2 a, 7/9; 12 v. 1 a, 7/11; 6.3 v. 3 a, 8/11; 6.3 v. 6 a, 17/6; 12 v. 3 a or 2.4 v. 1.5 a, 17/6.

CHARGER TRANSFORMERS

All with 200-230-250 v. 50 c/s Primaries: 0-9-15 v. 1 1/2 a, 11/9; 0-9-15 v. 3 a, 18/9; 0-9-15 v. 5 a, 19/9; 0-9-15 v. 6 a, 22/9.

SMOOTHING CHOKES

250 mA 5 H 100 ohms ... 11/9
150 mA 7-10 H 250 ohms ... 11/9
100 mA 10 H 175 ohms Potted ... 8/9
80 mA 10 H 350 ohms ... 4/8
60 mA 10 H 400 ohms ... 4/11

OUTPUT TRANSFORMERS

Midget Battery Pentode 66 : 1 for 354, etc. 3/9
Small Pentode 5,000 Ω to 3 Ω ... 3/9
Standard Pentode 5,000 Ω to 3 Ω ... 4/9
Standard Pentode 7,800 Ω to 3 Ω ... 4/9
Standard Pentode 10,000 Ω to 3 Ω ... 4/9
Multi-ratio 40 mA 30 : 1, 45 : 1, 60 : 1, 90 : 1, Class B Push-Pull ... 5/6
Push-Pull 10-12 watts 6V6 to 3 Ω or 15 Ω. Sectionally wound ... 16/9
Push-Pull 10-12 watts to match 6V6 to 3-5-8 or 10 Ω ... 16/9
Push-Pull 20 watts, sectionally wound 6L6, KT68, etc., to 3 or 15 Ω 47/9
Williamson type exact to spec. ... 85/-

SILVER MICA CONDENSERS. 5, 10, 15, 20, 25, 30, 35, 40, 50, 100, 120, 150, 200, 230, 300, 400, 500, 1,000 (.001 mfd.), 2,000 pfd. (.002 mfd.), 6d. each; 3/9 doz. One type.

H.T. ELIMINATOR AND TRICKLE CHARGER KIT. Input 200-250 v. A.C. Output 120 v. 40 mA. Fully smoothed and rectified supply to charge 2 v. accumulator. Price with covered metal case and circuit, 29/6. Or ready for use, 8/9 extra.

EX-GOVT. TRANSFS, 230/250 v. 50 c/s. 8.8 v. 4 a, 9/9; 48 v. 1 a, 9/9; 480 v. 200 mA, 6.3 v. 5 a, 27/9; 325-0-325 v. 150 mA, 6.3 v. 4-6 a, 5 v. 2-3 a, 27/9; Carr. on following types, 5/- extra. 7.7 v. 7 a, C.T. 4 times, 25/9; 400 v. C.T. 150 mA, 4 v. 6 a, 6.3 v. 6 a, 6.3 v. 0.6 a, 4 v. 6 a, 4 v. 3 a, 4 v. 3 a, 5 v. 2 a, 22/9.

EX-GOVT. AUTO TRANSFORMERS 50 c/s. Double wound 10-0-200-220-240 v. to 10-0-275-295-315 v. 1,000 watts. Suitable for 110 v. to 230-250 v. or reverse if windings series connected, 59/6. Single winding 15-10-5-0-195-215-235 v. 500 watts, 27/9.

EX-GOVT. SMOOTHING CHOKES 250 mA, 10 H 50 ohms ... 14/9
150 mA, 10 H 100 ohms ... 11/9
100 mA, 6-10 H 150 ohms Trop. 6/9
100 mA, 10 H 150 ohms Trop. 3/11
L.T. type 1 amp. 2 ohms ... 2/9

EX-GOVT. METAL BLOCK (PAPER) CONDENSERS 4 mfd. 500 v., 2/9; 4 mfd. 1,500 v., 4/9; 6-6 mfd. 400 v., 5/11; 8-8 mfd. 500 v., 6/9; 4 mfd. 400 v., plus 2 mfd. 250 v., 1/11; 8 mfd. 500 v., 5/9; 15 mfd. 500 v., 6/9.

EX-GOVT. E.H.T. SMOOTHERS .02 mfd. 8,000 v. cans, 1/11; .25 mfd. 4,000 v. Blocks, 4/9; .5 mfd. 2,500 v. Blocks, 3/8; .5 mfd. 3,500 v. cans, 3/3; 1.5 mfd. 4,000 v. Blocks, 5/9.

EX-GOVT. VALVES (NEW)

Each	Each	Each
1T4 7/9	6V6GT 6/9	6AT6 8/9
1R5 7/9	6X5GT 7/9	EL32 3/9
1S5 7/9	6U7 7/11	EF36 4/9
5Y3G 9/6	12A6 7/9	EB91 8/9
5Z4G 9/6	15D2 4/9	EF91 7/9
6KT7 5/11	25Z4G 9/9	KT68 11/9
6K8G 9/9	35Z4GT 10/6	SP41 1/11
6SN7GT 8/9	6L6G 11/9	SP61 2/9

RF26 UNITS BRAND NEW, CARTONED. Only 39/6. Carr. 2/6.

RADIO SUPPLY CO. (Leeds) LTD.
32, THE CALLS, LEEDS, 2 (For Terms see full page advert.)

For maximum reliability

'LECTROPACK'

ETCHED FOIL ELECTROLYTICS

The Constructor depends upon the reliability of the components he uses. The fact that so many designers specify T.C.C. Condensers is evidence of their supremacy.

T.C.C. "Lectropack" Dry Electrolytic Condensers are robust yet compact and employ ALL-ALUMINIUM non-corrosive internal construction. The range below is a useful guide to the types available.

Capacity [μF.	D.C. Volts		Ripple Current Max. M.A	Dimensions in inches		T.C.C. Type No.	List Price
	Wkgs.	Surge		L	D		
60 - 100	275	325	450	4 1/2	1 1/2	CE 37 HE	16/-
60 - 250	"	"	530	4 1/2	1 1/2	CE 60 HE	28/-
100 - 200	"	"	650	4 1/2	1 1/2	CE 60 HEA	28/-
100	350	400	450	2 1/2	1 1/2	CE 10 LE	13/6
200	"	"	770	4 1/2	1 1/2	CE 36 LE	24/-
60 - 100	"	"	500	4 1/2	1 1/2	CE 36 LEB	23/-
60 - 250	"	"	500	4 1/2	1 1/2	CE 60 LEB	34/-
100 - 100	"	"	550	4 1/2	1 1/2	CE 36 LEA	26/-
100 - 200	"	"	700	4 1/2	1 1/2	CE 60 LEA	33/-
60	450	550	450	3 1/2	1 1/2	CE 38 PE	14/-
60 - 100	"	"	500	4 1/2	1 1/2	CE 60 PE	29/-



List 140c contains the extended range.



THE TELEGRAPH CONDENSER CO. LTD

RADIO DIVISION: NORTH ACTON · LONDON · W3 · Telephone: ACOrn 0061

HENRY'S

(RADIO LTD.)

CRYSTAL MICROPHONE INSERTS

CATHODE RAY TUBES

(Brand New)

- VCR97 (slight cut-off) 15-
- VCR97 guaranteed full T.V. Picture 40-
- VCR517C, guaranteed full T.V. Picture 35-
- VCR139A, guaranteed T.V. Picture 35-
- 3BP1, guaranteed full T.V. Picture 30/-
- Carr. & packing on all tubes, 2/-.

B.S.R. 3-SPEED AUTO-CHANGERS

These are brand new in original cartons. Plays mixed records. Cream finish. List price £15.19.9 Our Price £7.19.6, carr. 3/-.

WALKIE-TALKIE SETS TYPE 3F

Complete with 5 valves, 4 VP23 and ATP4. Throat Microphone, Junction Box and Whip Aerial, all in good condition. All sets air tested and guaranteed. 59/6, carr. 5/- (Suitable new batteries and leads, £1.2.6 set.)

AN APA-1 CATHODE RAY INDICATOR AMPLIFIER UNIT.

Complete, comprising 3BP1 C.R.T., 7-6SN & gts., 1-61B6, 1-6C6, 1-2X2, 1-6X5, valves. Brand new, £4.19.6, plus carriage 7/6.

"R.F. 26" F.M. CONVERTER UNIT

88-100 Mc/s

We can now offer this self-contained Unit comprising 6 valves: 2-6BA6, EB91, VR137, EF54, EF54. Two I.F. stages and separate local oscillator, also Muirhead Graduated Vernier Drive ensuring easy tuning.

Components offered to Complete F.M. Unit New RF "26" Unit with 3 valves, VR137, EF54, EF54. Chassis stamped out for easy conversion £1.15.0

Complete set of all components for conversion including 2-6BA6 and EB91, tuning condenser, I.F.Ts and Osc. coils, resistors and fixed condensers, plugs, wire and tag strips... £4.12.6 Instruction Book with technical circuit and complete lay-out diagrams ... 2.0

Special offer of all above items and RF26, including circuit, postage 3/- 26.5.0 Charge for alignment when completed ... 7.6 Assembled, aligned and ready for use ... £8.10.0 All items sold separately.

VIBRATOR PACKS, ETC.

- Input 12 v., output 244 v., 44 mA..... 25/-
- Input 6 v., output 180 v. at 40 mA..... 21/-
- Vibrator Transformers 6 v. 180 v. 40 mA..... 7/6
- Vibrator Transformers 6 v. 250 v. 80 mA..... 8/6
- Vibrator Trans-formers 12 v. 250 v. 80 mA 8/6
- Vibrators 6, 12 or 24 v., 4 pin 5/-
- Vibrators 6 v. 7 pin synchronous 12/6
- Vibrators 12 v. 7 pin synchronous 12/6
- Vibrators 2 v. 7 pin synchronous 7/6

PYE 45 Mc/s STRIP TYPE 3583 UNITS

Size 15in. x 8in. x 2in. Complete with 45 Mc/s Eye Strip, 12 valves 30 EF50, EB34 and EA50, volume controls and hosts of Resistors and Condensers. Sound and vision can be incorporated on this chassis with minimum space. New condition. Modification data supplied. Price 69/6. Carriage paid.

VALVES - VALVES - VALVES

WE HAVE OVER 50,000 AMERICAN AND ENGLISH VALVES IN STOCK AT VERY LOW PRICES. SEND 3d. FOR 28-PAGE ILLUSTRATED CATALOGUE.



POST FREE POST FREE

Ideal for tape recording and amplifiers. No matching transformer required.

EF50 (VR91A)
The selected EF50, Red Sylvania, original boxes, 10/- each, 90/- for ten.

82A INDICATOR UNIT
Containing VCR97 with Mu-Metal Screen 21 valves - 12-EF50, 4-SP61, 3-EA50, 2-EB34. Plus Pots., Switches, H.V. Cond., Resistors, Muirhead S.M. Dial, Xtal, Double Deck Chassis. BRAND NEW. ORIGINAL CASES, 67.6 carr. 7.6.

U.S.A. INDICATOR UNIT Type BC929A

These Units are in absolutely new condition. In black crackle cabinet 14 1/2in. x 9in. x 9in. Complete with 3BP1 C.R. Tube, Shield and Holder, 2-4N7GT; 2 6H6GT; 1 6X5CT; 1 2X2; 1 6C6; V controls, condensers, etc. Ideal for scope. 65/-, Carr. Pd.

SAVE £££'s!

BUY DIRECT FROM A FAMOUS MANUFACTURER

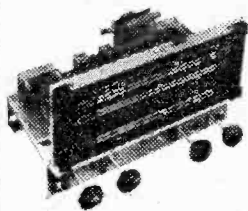

Packing and
Carriage for
either chassis 12/6

RADIO RECEIVER CHASSIS

Built to the highest specifications, these chassis offer the finest value to the enthusiast. Supplied with set of selected knobs. Socket panels for aerial, earth, speaker, Pick-up and Gram motor. 200/250 v. 50 cycles only.

Type A : 5 valves 3-wavebands Superhet with full negative feedback and A.V.C. Built-in Ferrite antenna. Full range tone control
£9.19.6.

Type B : 7 valves 3-wavebands Superhet with specially designed Push-pull output stage. Separate Bass and Treble control
£15.4.6.

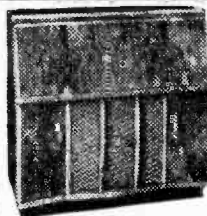

CABINETS

The magnificent Bureau type Cabinet illustrated is in specially selected walnut veneered exterior with light Sycamore interior with matching Rexine lining. Two full-sized compartments. Overall measurements : 34in. 17in. x 33in. high.

Price £17.0.0.

Other high quality cabinets are available at prices ranging from 10 gns.

Packing and Carr. 15/-.

UNBEATABLE VALUE! TAPE RECORDER

In a superbly fitted Moroccan grained carrying case, this instrument is the very finest of its class, regardless of price. Latest type TRUVOX twin-speed Tape-deck. Input for Radio, Gram and Microphone. Built-in, selected elliptical speaker of the very finest quality. Recording (with Recording level indicator) or Playback. 200/250 v. 50 cycles, A.C. only. Supplied complete with selected Microphone and Recording Tape.

42 gns.



SPECIALLY RECOMMENDED

DISC PLAYER

Specially designed for the amateur builder, these Disc Players consist of the latest three-speed Automatic Record Changers, complete with crystal turn-over pick-up head for long-playing and standard records, mounted on Sycamore lined base. Supplied complete with fitted Mains lead and screened pick-up lead, ready for connecting up.

£10.16.0.

Packing and Carr. 7/6.

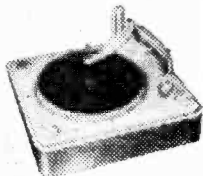

Write now for fully illustrated catalogue of the complete range of equipment which contains full details of our generous Hire Purchase Terms applicable to all goods above £15.

**ALL FULLY GUARANTEED
GENEROUS HIRE PURCHASE TERMS**

**DOMESTIC DIRECT SALES LIMITED
36, SOUTHAMPTON ST. STRAND LONDON W.C.2**

Brenell

—best value
in quality
Tape Decks

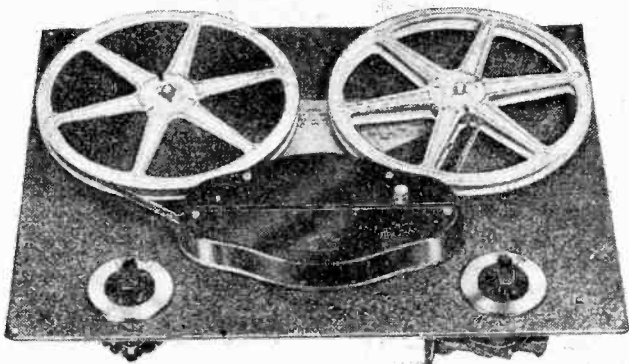

WITH ALL THE FEATURES — at a price anyone can afford **18 GNS**

- Heavy Duralumin Baseplate 15" x 11½"
- Three independent motors
- Three speeds: 3½, 7½ and 15 i.p.s.
- Twin-track recording, 7" reels (1,200 ft.)
- Foolproof "drop in" tape loading
- Instant stop without tape spill
- High efficiency mechanical braking system
- Two-knob control with interlocked switching
- Visual playing time indication
- Fast forward or reverse in 45 seconds
- Plays all makes of pre-recorded Tapes
- Azimuth adjustment to Record/Playback Head

BRENELL RECORDING AMPLIFIER NOW AVAILABLE AT 16½ GNS

From your Wireless Dealer or in case of difficulty write to sole manufacturers:

BRENELL ENGINEERING CO. LTD., 2 NORTHINGTON ST. LONDON, W.C.1 • Tel: HOLborn 7358



Corner Console. A massive cabinet but being corner fitted is not out of place even in a modern small living-room. Overall dimensions of this cabinet are 47in. wide x 31in. (deep to corner) x 50in. high. Made to house "15" Television, Radio Unit, Amplifier, Tape Deck, etc. Originally £18—our price, £10, plus 30/- carriage.

TUNING CONDENSER

.0035 mfd. 2 gang. Ceramic insulation.
Price 4/-
Post 9d.

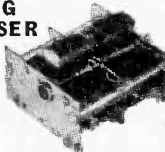

THIS MONTH'S SNIP

MAINS TRANSFORMER 9/6

Post 2/-
Fully shrouded—standard 300-250 v. primary. Sec. 230-0-230 at 80 mA., 6.3 v. at 3 amp., 5 v. at 2 amp.



THREE-SPEED GRAM MOTOR
200-240 A.C. mains-operated, complete with turntable, plays 33, 45 and 78 r.p.m. records.



226 FLUORESCENT LIGHTING
40 WATT
Kit comprises battery control unit, starter lamp, lamp holder, clips and wiring diagram. Price, less tube, 22.6, plus 1.6 post. With tube, 30/-, plus 3.6 carriage and insurance.

5-VALVE SUPERHET YOURS FOR ONLY 40/- DOWN

Chassis size approx. 9" x 7" x 6". First-class components. A.C. mains operation. Three wave (medium and short). Complete with five valves, ready to work. New and unused. Cash price £5-19.6. or N.P. terms (carr. and ins. 7.6).

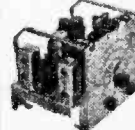

THE CLEVELAND F.M. TUNER

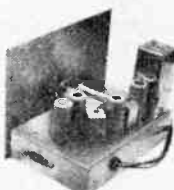

This tuner is based upon the very successful circuit published by Data Publications—it is sometimes incorrectly known as "Jason" circuit. We have made up models at all branches and will gladly demonstrate. Stability is extremely good and making and aligning most simple. With only a simple indoor aerial this tuner works very well at Eastbourne (over 60 miles from London) and we await reports from even greater distances. Cost of all parts including valves, prepared metal chassis, wound tuning knob, in fact everything needed is £8/12.6. Data is included free with the parts or is available separately, price 2/-. Extra parts for fringe area model, 20/-.

COMMERCIAL T.V. KIT 42/6

One of the most successful circuits for Band III conversion was published in the "Wireless World," May, 1954. The results we have received in our Eastbourne laboratory have been more than satisfactory and we consequently offer a complete kit of parts including the specified EF80 valves, wound coils, drilled chassis—in fact, everything and a copy of the circuit diagram. Price only 42.6, post 2/6 extra. Mains components it required 25/- extra.

IMPORTANT NOTE

Customers, old and new, please note our post order and enquiry department is now being run from Eastbourne, and we can promise a much better service than of late. Please send S.A.E. with enquiries.

CABINETS FOR ALL

We undoubtedly hold the largest stock of cabinets in the country. All are made of the finest plywood, veneered and polished, and all radio and motor boards are left uncut to suit your own equipment. The top one is The Bureau,

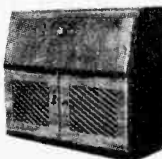

walnut finished and highly polished, size approximately 30in. high, 32in. wide, and 16in. deep. Price 16 guineas or H.P. terms available carr. 12/6. The centre one is The Empress, our most popular cabinet, size 32in. high, 36in. wide, and 16in. deep, walnut finished, lined sycamore. Price 15 guineas, or H.P.

MAKING A SOLDER GUN



A 7-second solder gun of the type costing £1-4, as described in the August issue of "Practical Mechanics." Only two essential parts are required: (a) the transformer and (b) the push switch. These we can supply at 13/8, plus 2/- post. The rest of the parts you will have in your own "junk" box. Copy of the article concerned given free with the kit.

THE SENSITIVE TWO VALVER

The circuit and constructional details of a small but useful portable high-gain all mains receiver appeared in the August issue of Practical Wireless. We will supply all parts listed on pages 481 and 482 at a special price of 57/6, plus 2/6 post.

GRAMOPHONE AUTO-CHANGER

The latest model by very famous manufacturers. 3-speed with "Hi-G" crystal turnover pick-up, brand new and perfect. In original cartons. Price £9/17.6, carriage, etc., 7/6.



THE TWIN 20

This is a complete fluorescent lighting fitting. It has built-in ballast and starters—stove enamelled white and ready to work. It is an ideal unit for the kitchen, over the work-bench, and in similar location. It uses two 20-watt lamps. Price, complete less tubes, 29/6, or with two tubes, 39/6. Post and insurance 2/6. Extra 20-watt tubes, 7/6 each.



MAINS-MINI

Uses high-efficiency coils—covers long and medium wavebands and fits into the neat white or brown bakelite cabinet—limited quantity only. All the parts, including cabinet, valves, in fact, everything, £3/19.6, plus 2/- post. Constructional data free with the parts, or available separately 1/6.

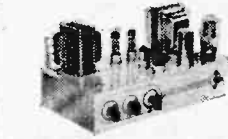

MULLARD AMPLIFIER "510"

A Quality Amplifier designed by Mullard. Power output exceeds 10 watts. Frequency response almost flat from 10 to 20,000 C.P.S. For use with the Acos "Hi G" and other good pick-ups. Made up and ready to work is £12/10/- or 85/- deposit, plus 10/- carr. and insurance. Available in kit form. Send for Mullard Shopping List.

FREE

THIS MONTH



To encourage customers to use our post service, we are giving a set of 2, 4 and 6 B.A. folding spanners free with all post orders of 10/- and over this month.

ELECTRONIC PRECISION EQUIPMENT, LTD.

Post orders should be addressed to Dept. 7, 123, Terminus Road Eastbourne.

Personal shoppers, however, can call at:

- 42-46, Windmill Hill, Ruislip, Middx. Phone: RUISLIP 5780 Half day, Wednesday.
- 152-3, Fleet Street, E.C.4. Phone: FLEET 2833 Half day, Saturday.
- 29, Stroud Green Road, Finsbury Park, N.4. Phone: ARCHWAY 1049 Half day, Thursday.
- 249, High Road, Kibbory, Maidstone. Phone: MAIDA VALE 4921, Half day, Thursday.

What's all this about Hi-g?



"g" is the symbol for acceleration which, to the technical, is defined as the differential of velocity with respect to time. More simply this means the rate of change of speed.

When "g" is too great, damage will be done. A locomotive leaves the rails when it takes a curve too fast. At only 6 "g" a pilot blacks out when he pulls out of a dive; at 20 "g", which is very much more than any plane can possibly encounter, the plane would disintegrate.

The stylus tip of a pick-up is subjected to the same acceleration but to an infinitely greater extent. The undulations of a record groove cause the stylus to vibrate as much as 10,000 times per second or more. It moves to one side of the groove, stops, moves to the other, stops again and so on throughout the record. **The accelerations acting upon the stylus tip are measured in "g" and with modern recordings may be well over 1000 "g".**

Obviously a light freely suspended stylus will follow rapid changes of direction in record grooves more easily than a heavy, stiffly mounted one. On a heavily recorded record a "stiff" pick-up will tear through record grooves or even jump right out of them. Result: rapid record and stylus wear and poor reproduction.

Correct tracking of modern electrical recordings with their great musical and dynamic range calls for pick-ups specially designed to cope with very high "g". They are available, after much patient research and development, under the name "Hi-g". **ACOS "Hi-g" pick-ups perform perfectly at any multiple of "g" they are called upon to meet,** representing a truly revolutionary advance in pick-up design. If you want your valuable records to reproduce as well as the makers intended—and to go on doing so for a long time — use an "ACOS Hi-g" pick-up.

(Write for a free copy of the new Cosmocord booklet "The ABC of Hi-g".)



... always well ahead



ACOS devices are protected by patents, patent applications and registered designs in Great Britain and abroad.

COSMOCORD LIMITED • ENFIELD • MDDX • Tel: ENField 4022

PRACTICAL WIRELESS

EVERY MONTH
VOL. XXXI No. 588 OCT., 1955

EDITOR: F. J. CANN

23rd YEAR
OF ISSUE

COMMENTS OF THE MONTH

BY THE EDITOR

"The Practical Householder"

DETAILS OF OUR NEW COMPANION MONTHLY

AS announced last month the first issue of our new companion journal, *The Practical Householder*, will be published on September 8th, and an illustration of its three-colour cover appears below. It will deal with every practical household topic from decorating and painting, wallpapering, making pelmets, and garden furniture, overhauling the hot-water systems and repairing the plumbing, making furniture, laying brickwork, to overhauling the lawn mower, the sewing machine, refrigerator and washing machines, and it will even tell you how to build your own house.

The first issue contains a valuable 24-page *Practical Householder's Booklet*, packed with information for everyday use. You may judge the "Do it Yourself" policy of the newcomer from the contents of the first issue which include Paperhanging Made Easy; A Simply-made Table Lamp; Interior Decorating; Repairing Simple Plumbing Faults; Making an Electric Gas-lighter; Making Your Own Loose Covers; Enamelling a Bath; Uses for Repair Plates; Laying Linoleum; Reglazing and Painting on Glass; An Electric Water Heater; A Household Ozoniser; An Automatic Draught Excluder; Making Rugs; Building Your Own Bungalow; Concrete Paths and Floors; An Ash-pan Improvement; Making Pelmets; Legal Notes—Landlord's Fixtures; Checking Over Your Vacuum Cleaner; Passing It On; Making a Hall Lantern; Painting, Staining and Varnishing Floors, etc.; A Reliable Folding Table; Letters to the Editor; and The Home Mechanic's Shop Window.

This journal is a "must" for everyone

who takes an interest in the home. You will only make certain of obtaining it month by month by placing an order for its regular delivery with your newsagent. Remember the date *September 8th* and order your copy now.

SPACE TRAVEL AND RADIO

A great deal of experimental work is now in progress in connection with radio apparatus for the artificial satellites which will be launched as a prelude to trips to the moon.

This is bound to lead to great improvements in radio apparatus, but we do not share the view held in some quarters that trips to the moon are imminent. No doubt the very first landing will be by guided rockets piloted by robots. The important point, however, is that such a trip, whether man-powered or otherwise, will depend on radio equipment for its success so that contact can be maintained with the earth.

The apparatus required for such a venture must be delicate, complicated and accurate. In this connection we record with pleasure that the Mullard Company has offered to provide the University of Cambridge over a period of 10 years with the sum of £100,000 to continue and co-ordinate the work in radio astronomy now undertaken in the Cavendish Laboratory. The new observatory will be known as the Mullard Radio Astronomy Observatory and it will probably be located near Cambridge. It will be remembered that work in connection with radio astronomy commenced simultaneously in Cambridge and Manchester soon after the war. Cambridge has already produced a special radio telescope and other special apparatus is already under construction.

—F. J. C.

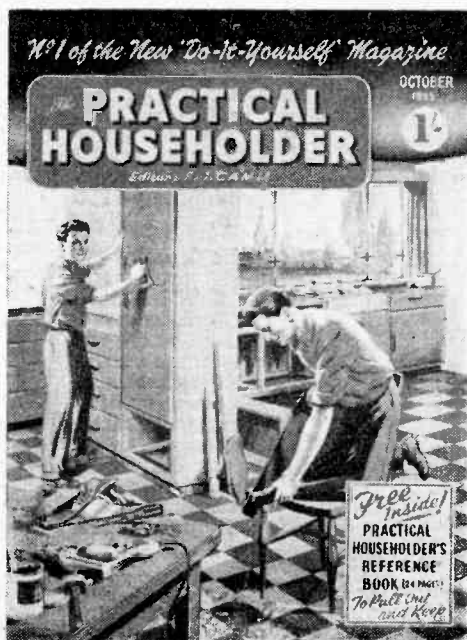



Round the world of WIRELESS



Broadcast Receiving Licences

THE following statement shows the approximate number of broadcast receiving licences in force at the end of June, 1955. The grand total of sound and television licences was 14,035,567.

Region	Number
London Postal	1,450,057
Home Counties	1,398,479
Midland	1,126,525
North Eastern	1,493,319
North Western	1,146,432
South Western	933,595
Wales and Border Counties	584,117
Total England and Wales	8,132,524
Scotland	1,007,213
Northern Ireland	219,408
Grand Total	9,359,145

Retirement

MISS MARY SOMERVILLE, O.B.E., Controller of BBC Talks Division, is to retire on

By "QUESTOR"

December 31st after thirty years' service with the BBC.

Miss Somerville, who was appointed a Controller in 1950, is the only woman to hold such a post with the BBC, and has been associated with broadcasting for Schools since she joined the Corporation in 1925.

"British Band Box"

JACK PAYNE'S Sunday afternoon record series "British Band Box," featuring dance music recorded by leading British bands, is to continue until mid-December.

Radar Scanner

THE London Forecasting Section of the Meteorological Office is experimenting with the Decca Type 41 storm-warning radar scanner.

It is expected that the apparatus, installed at a cost of £5,000, will help to increase accuracy in weather forecasting. It records echoes of heavy rain or storms up to a radius of approximately 150 miles.

Cable Capacity

INCREASE operation carried out recently in the Channel on one of the two submarine cables directly linking Porthcurno, near Land's End, with Gibraltar, on the eastern cable route to Australia and the Far East, is expected to increase its word-carrying capacity by 50 per cent.

A submarine telegraph-repeater, or valve amplifier in watertight container, was inserted in the cable by Cable and Wireless, Ltd. It was the first telegraph repeater to have been put in operation in any of the company's submarine cables.

Radio Amateurs' Examination

CLASSES for the above examination and the Post Office Morse Test are to be held this winter at Wembley Evening Institute, Copland School, High Road, Wembley, beginning Monday, September 19th.

Both Morse and radio theory will be covered in the syllabus, classes being held each Monday, Morse from 7 to 8 p.m. and radio theory from 8 till 10 p.m. Enrolment takes place each evening from Monday, September 12th, to Thursday, September 15th.

S. African Trawler Installation

THE new steam trawler *Groote Schuur*, built at Beverley by Cook, Welton and Gemmell, Ltd., for Irvin and Johnson (South Africa), Ltd., has been fitted with the latest radio and echometer equipment by technicians of the Hull depot of The Marconi International Marine Communication Co., Ltd.

Speech communication facilities are provided by a "Gannet" radiotelephony transmitter-receiver.

S.W. Transmitters

STANDARD TELEPHONES AND CABLES, LIMITED, have been awarded an important contract for the supply of twenty-three 30 kW short-wave transmitters to the British Post Office.

They will be installed at three of the British Post Office Radio Transmitting Stations and are to be employed for point-to-point multi-channel telephone and telegraph services between the United Kingdom and all parts of the world.

Staff Change

MR. F. G. ROBB, having reached retirement age, has relinquished his position as chief of

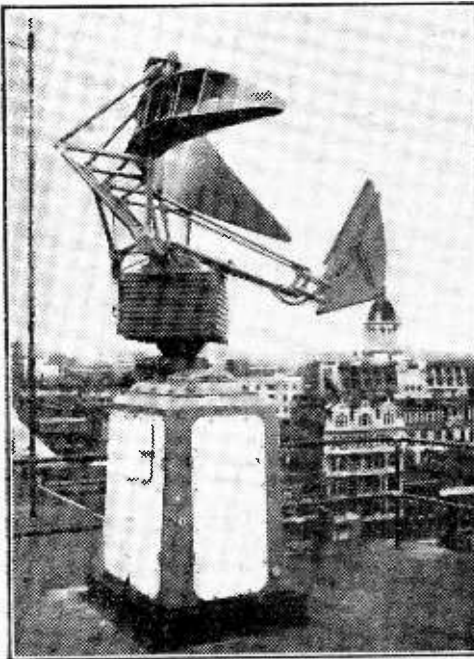

The Decca type 41 radar scanner on the roof of the Meteorological Office in Kingsway. (See "Radar Scanner.")

the test division of Marconi Wireless Telegraph Co., Ltd., and is succeeded by Mr. E. H. Evans.

Mr. Robb was with Marconi's for thirty-six years and Mr. Evans first joined the company in 1913.

Pioneer's Memorial

THE Signal Corps Museum of the United States Army at Fort Monmouth, New Jersey, has been dedicated to the memory of radio pioneer Major Edwin H. Armstrong. A plaque inscribed with the words "Armstrong Hall" has been unveiled.

Training For Iranians

THE Government of Iran is to modernise its radio communications system to Europe and overseas countries by setting up a high quality independent sideband radio telephone and telegraph service.

Marconi are to supply and install the complicated receiving equipment and also train Iranian engineers in the use of it. Some of this training will take place at Chalmers Works in Essex and at the Marconi College.

"Miss Stentorena"

AT the Sports Club Garden Fête of Whiteley Electrical Radio Co., Ltd., Miss Valerie Dean was proclaimed "Miss Stentorena" for 1955 by Mrs. A. H. Whiteley. Miss Dean, who is also Maid of Honour to the Area Coal Queen, is a press-drill operator with the firm and was presented with a prize of five guineas by Mr. A. H. Whiteley.

The fête was attended by more than 500 guests.

V.H.F. in Austria

ONLY 15 per cent. of radio listeners in Austria are able to receive transmissions on V.H.F.

This low proportion is partly due to the lack of adequate transmitters. The Austrian Broadcasting Corporation is, however, preparing a second plan to develop the service and 10 new V.H.F. transmitters are to be constructed by the end of 1957.

Cable Across the Ocean

A TELEPHONE cable which is being laid across the Atlantic Ocean will commence operation next year.

Two submarine cables will stretch 2,250 miles between Newfoundland and Scotland and amplifiers of original design and structure will be placed at intervals along the line.



Mrs. A. H. Whiteley crowns Miss Valerie Dean at the Whiteley Electrical Radio Company's garden fête. (See "Miss Stentorena.")

Boom in Germany

A SUBSTANTIAL increase in German radio exports is reported. This is probably due to the fact that import restrictions are unknown in many European countries.

Over 100 V.H.F. transmitting stations have been completed in Western Germany.

Breakdown Service by Radio

THE Automobile Association has announced the extension of its radio-controlled breakdown service to Liverpool and the surrounding area.

A special transmitter has been erected on the roof of the Cunard building, where the A.A. has its Area Office, enabling constant contact to be maintained with radio-equipped breakdown vehicles working by night within a radius of about 15 miles from Liverpool. Initially, the A.A. breakdown vehicles will operate daily after office hours and until midnight.

Coverage of Party Conferences

THE BBC Television Service will present three reports from the Conservative Party Conference at Bournemouth on the evenings of October 6th, 7th and 8th. The team will be headed by E. R. Thompson, the Parliamentary Correspondent, and will also supply material to the Sound domestic and Overseas Services for News and Radio Newsreel.

The BBC has made a similar offer to the Labour Party for its Margate Conference. The Labour

Party has agreed to coverage on the second day's open session on October 11th on an experimental basis.

L.C.C. Ambulances

THE London County Council is to experiment with a radio-telephone service for its ambulances.

A central station will be the nucleus controlling six ambulances and a staff car fitted with two-way radio. The cost will be just under £3,000.

Ultrasonic Generator

A LOW-FREQUENCY ultrasonic generator, Type E7696, has been developed by Mullard, Ltd., and is a new general-purpose equipment with an output power of 2 kW in the frequency range 10 kc/s to 30 kc/s. It has been designed as a power source for magnetostrictive transducers used for ultrasonic cleaning, degreasing, soldering, tinning and drilling.

Robust construction, automatic protection circuits and simple controls make the generator suitable for everyday industrial use.

Radar Traffic Control

A PATENT has been filed in America for a radar traffic control, especially applicable to underground and similar congested systems. Block systems ordinarily keep trains well spaced regardless of their speed. This radar system takes into account the speed of a train as well as its distance behind another.



ALTHOUGH at the time of going to press nothing startling or revolutionary has been announced it is quite clear that there will be certain well-defined sections at this year's show. The emphasis will undoubtedly be on the forthcoming ITA television transmissions, and accordingly a vast array of special aerials and converters will be seen, and these will be dealt with in our companion paper *Practical Television*. On the radio

side emphasis will be on the forthcoming F.M. transmissions on V.H.F., and high-fidelity reproduction. Associated with these features will be the special aerials which are necessary to pick up the F.M. signals, and the various speakers and speaker enclosures designed to go with the amplifiers.

SPECIAL NOTE

This review has been compiled from information supplied by exhibitors, as we go to Press with this issue before the show opens. The omission of certain exhibits is, therefore, explained by the fact that the manufacturers concerned have not, at the time of going to Press, supplied us with the information. Further reports appear next month.

The trend to better quality is very marked this year, and associated with the improvements are the various transistors and other "cold valves."

These are now available in a variety of types, and although the cost is somewhere in the region of 30s. each there is a saving in cost of the power supply. To offset this the sensitivity is lower so that a number of the components have to be used, and, furthermore,

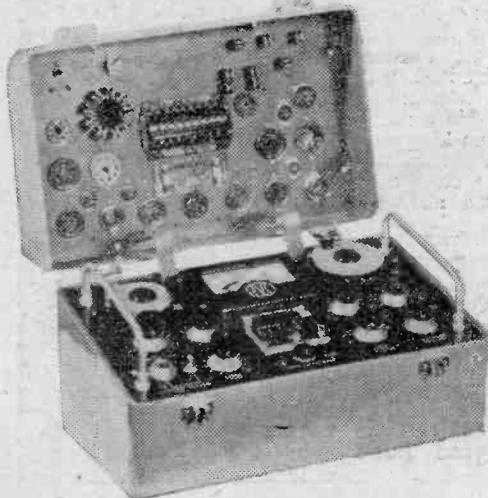

A comprehensive valve-tester from the AVO range.

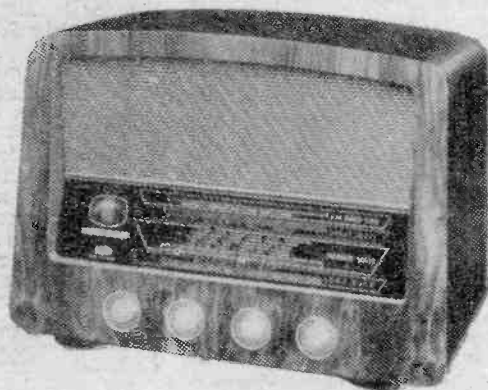

This Alfa receiver includes an F.M. band.

they are very easily damaged in wiring them into a receiver. There do not appear to be many receivers on show in which these are included, although various firms such as Mullard, G.E.C., Ferranti, etc., will be

frequency response than gramophone records also have a complete absence of background or surface noise, and as a result again give the listener much higher quality of reproduction than hitherto.

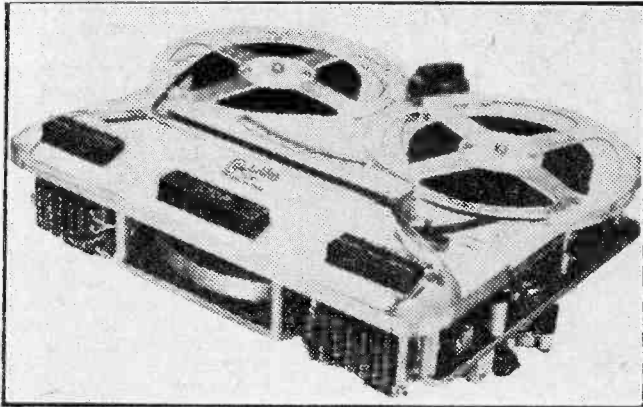

A tape transcriber by the well-known Collaro factory.

exhibiting their complete ranges.

High Fidelity

Dealing with the quality of reproduction first, there are some newcomers in the "Hi-Fi" market. Whiteley Electrical, makers of the well-known W.B. Stentorian loudspeakers, are now supplying a complete amplifier with tone-control unit, illustrated on page 595. This is a 12-watt unit and follows the pattern of many similar types of equipment, the tone control (with self-contained valve or valves) being totally enclosed and intended for mounting on a motor board or cabinet front, with the amplifier itself placed away in the lower part of the cabinet.

This W.B. unit costs £25. Another new item will be the G.E.C. 912-Plus, a modified version of the 12-watt amplifier which they produced some time ago. The new model has alternative inputs to accommodate radio signals on F.M., and improved compensating circuits for various pick-ups. Pick-ups will also be shown in some new models, designed again to give much better quality from the long-playing discs which are now on the market. In association with these radio units and amplifiers are the various tape recorders, which whilst giving much better

Loudspeakers

To do justice to these new amplifiers and improved quality, loudspeakers have been improved, and an increasing use is now being made of high-note reproducers. In addition to the W.B. tweeter, others will be seen, and the G.E.C. metal-cone speaker again comes into this class. At last year's show a number of firms were demonstrating speakers and speaker cabinets in which two speakers were included, one intended for the ordinary range of frequencies and the other for high notes. This year it would appear that this has been taken a stage further and three speakers are now the recognised "best." The large 12in. or 15in. model is used as a "woofer," or low-note reproducer, with a small electrostatic "tweeter" for the high notes (above 3,000 c.p.s.). A third 8in. model (a "squawker") is then included

for the middle range of frequencies, and thus, provided a suitable cabinet is employed, a much more even response is obtained. Certain speaker manufacturers, such as Goodmans, supply constructional data for the cabinets, whilst others, such as Whiteley Electrical, supply complete cabinets for their speakers. An important point for the amateur to bear in mind is that it is

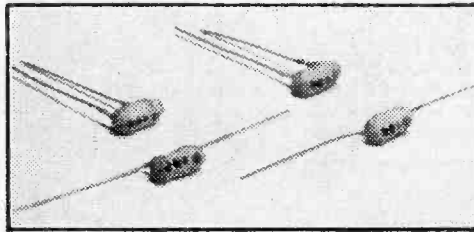

Some high "Q" and high "K" ceramic capacitors by Hunts.

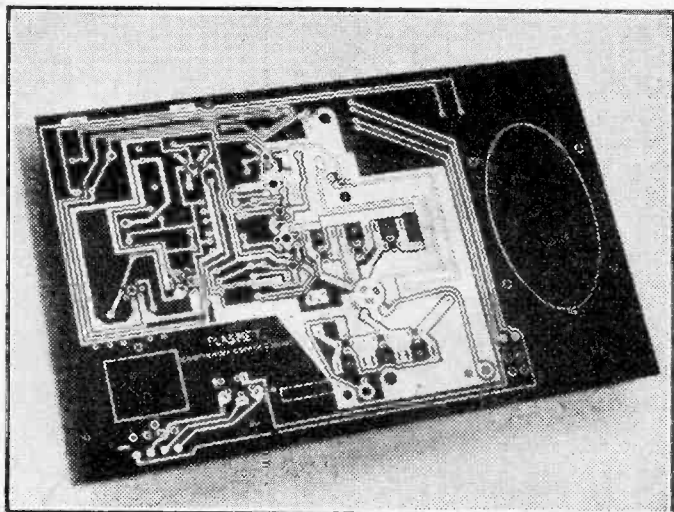

Typical printed circuit using the "Delaron" copper-clad material by De La Rue.

not generally satisfactory to buy one make of speaker and make up a cabinet design suggested by another maker. The fundamental resonance of the speaker is usually taken note of in designing the cabinet, and if these are indiscriminately mixed reproduction will probably be worsened instead of improved. The usual demonstration rooms, with suitable inputs from L.P. records, etc., enabled certain makers to illustrate the importance of these points. Apart from the electrostatic speakers and the fabric cone of the W.B. speakers, there does not appear to be any drastic change in the design of the loudspeaker, other than the use of a smaller magnet, which, with the improved materials now available, gives even greater field strength than older materials.

• Unfortunately, it does not appear that set makers have gone to any trouble to improve reproduction in the ordinary type of receiver, although in one or two cases emphasis is laid on the fact that the set is designed to take full advantage of the proposed new

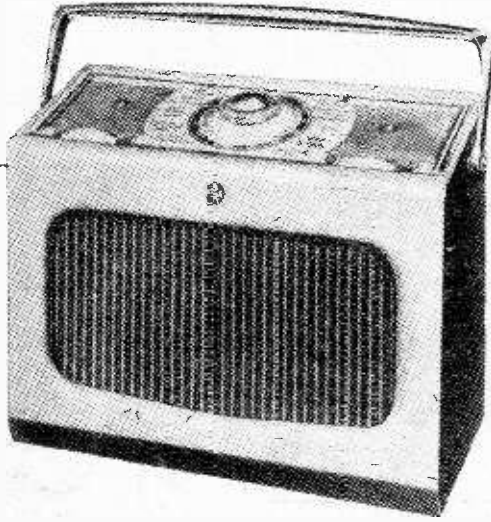

The "Vicki" portable by Invicta Radio, Ltd.

for the V.H.F. band. We have not yet had an opportunity of hearing any of these so cannot say whether they do justice to the higher quality of F.M. Portables appear in many new designs, and the A.C./D.C. battery arrangement appears to be standardised in these, with the Ferrite rod aerials giving better pick up of local signals and avoiding the necessity of turning the set around on its base. Coloured plastics are apparently being used more in the cabinet design of this type of receiver, and some very smart designs have been produced.

A very important new feature in many receivers is the use of printed circuit wiring. Two examples accompany this article,

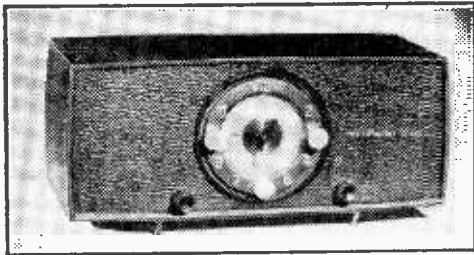

This is the clock-controlled radio, Model 1,127 by H.M.V.



An unusual design for a radiogram. This is H.M.V. Model 1,507.

F.M. transmissions. As these are, at the moment, available only to listeners in a limited area, this may account for the fact of fewer receivers with F.M. being available than will be the case when more stations are opened on V.H.F.

It is noticeable that several firms are producing table receivers in which the F.M. band is included, and most of these appear to employ a specially made gang condenser, having normal sections for the medium and long waves and a special small unit

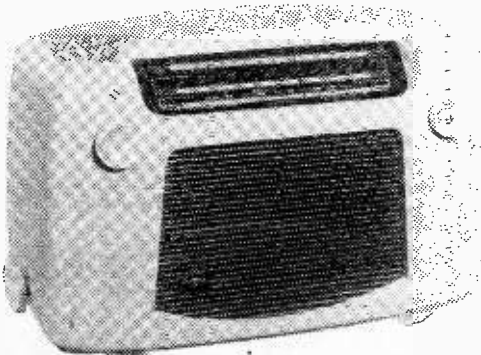

This K.B. receiver also includes the V.H.F. band for F.M. in addition to long and medium waves.

one on page 591 and another on page 594. The latter is a complete 4-valve battery portable, in which a T.C.C. printed circuit plate is used. The latter company is specialising in this class of work and some very novel samples are to be shown. Whilst this technique leads to compactness, it also prevents many servicing troubles which arise as a result of poor connections, although the serviceman will find that repairing such receivers will call for special care,

not only in the use of the soldering iron, but also in the selection of solder and fluxes. In the latter connection the makers of the well-known Multicore solder will be demonstrating some of their special products for the use of amateurs as well as the Trade.

In the "miniaturising" of receivers some inter-

vision receiver. A shelf underneath to take suitable books makes this a very useful piece of furniture.

A notable tendency is the more tasteful control knobs which are now being used. These are generally larger, and it would appear that the majority are in white. The contemporary design is carried farther in certain larger models by the use of some kind of material right across the cabinet front. Thus the elaborate use of figured woods appears to be on the

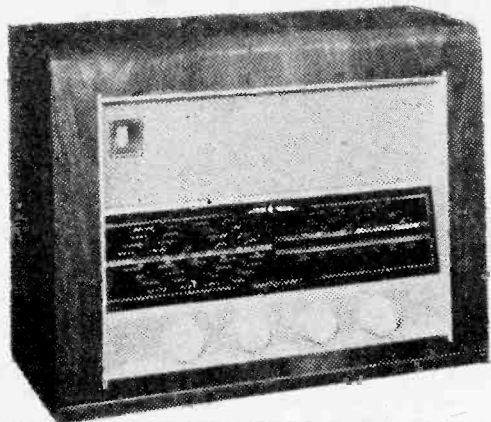

Another F.M. receiver. This is in the Bush range.

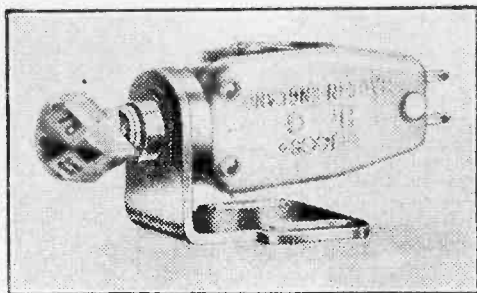

A Cosmocord turn-over 33-78 head.

esting developments will be shown. On page 592, for instance, is an H.M.V. table radiogram, the gramophone section being at the rear of the radio set, and in the closed position the general dimensions being no greater than the average table radio receiver. Regentone, too, have managed to crowd a gramophone, radio receiver and record storage cabinet all in the space normally occupied by the normal receiver, whilst in the field for space saving McMichael have produced a two-band receiver in the form of a table (page 595) designed to accommodate on top a normal table model tele-

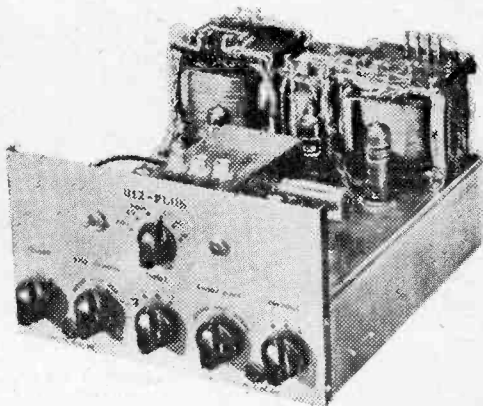

The latest model of the G.E.C. 912 amplifier to be known as the 912-Plus.

way out, and apart from the general reduction in size the use of plainer feet or legs, with the use of fabric-covered front, makes the modern receiver much less conspicuous and more suitable for modern house furnishings. Unfortunately this type of design is marred in many cases by the retention of the large tuning scale, and we would like to see a return to the mechanical selection of stations—either by a rotary switch or modern push-button units. When the I.T.A. programmes are available, and F.M. is general, one will have a choice of seven or eight

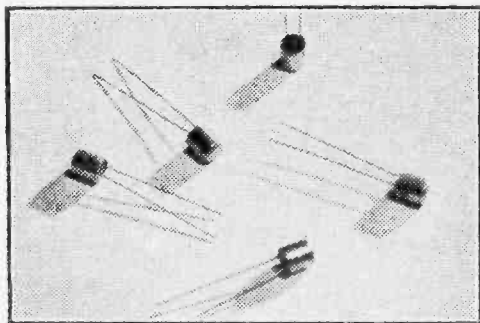

A group of silicon junction diodes by Ferranti.

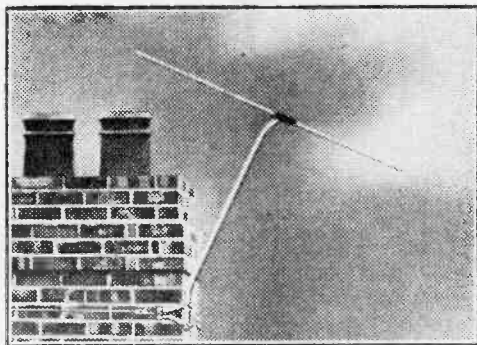

A dipole for F.M. transmissions. A Belling-Lee product.

programmes at any time, and it would appear that the normal domestic need for "station searching" will vanish, leaving that for the enthusiast who would use a receiver specially designed for the purpose.

Aerials

With the introduction of the F.M. transmissions a new aerial is required in the majority of situations. This signal is horizontally polarised, and calls for a horizontal aerial, in its simplest form, a dipole. Typical of these is the Belling-Lee shown on page 593, and for those in a fringe area a more elaborate assembly will be needed such as the Wolsey shown on the right.

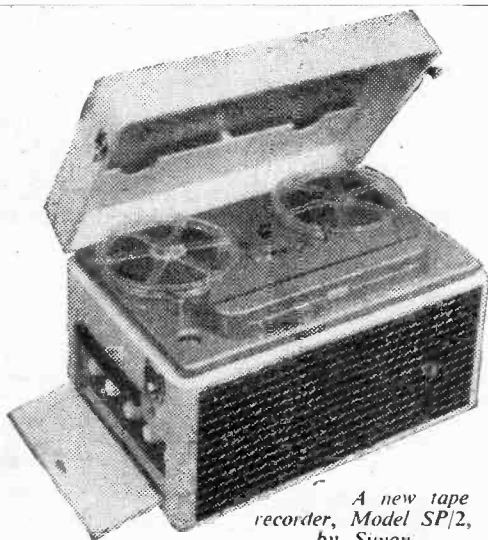

A new tape recorder, Model SP/2, by Simon.

The difficulty of housing this multiplicity of aerials has been tackled by the aerial manufacturers and some novel combined arrays are to be shown by Belling-Lee, Aerialite, Wolsey and others. Steps to make the aerial resonant to either Band I or Band III have already been taken, and the horizontal F.M. aerial may be placed in the centre of such an array. Where, of course, the BBC television transmission is also horizontally polarised additional difficulties will arise, but some novel aerial arrays will certainly be seen in some districts.

Components

Finally we come to the main interest of the home-

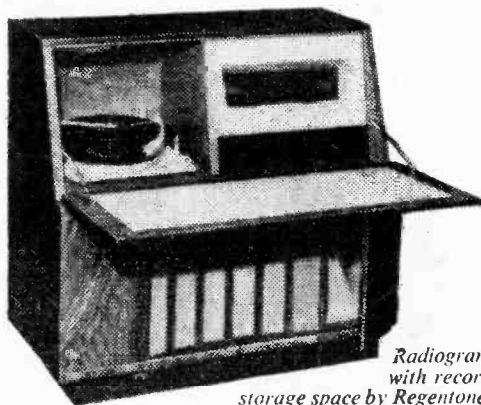

Radiogram with record storage space by Regentone.

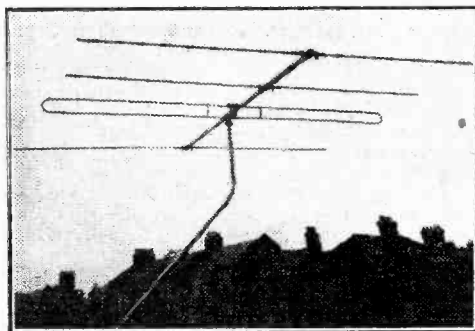

A Wolsey Yagi array for F.M. reception in fringe areas.

Unfortunately, the new ITA television transmissions also call for a different aerial, and this means that in some districts a house will be adorned with a separate Yagi array for each of Band I, Band III and F.M. These cannot all be sited on one chimney stack, and whilst in some districts one or more may be stowed away in a loft without any loss in other places it will be essential to retain them out in the open and as high as possible.

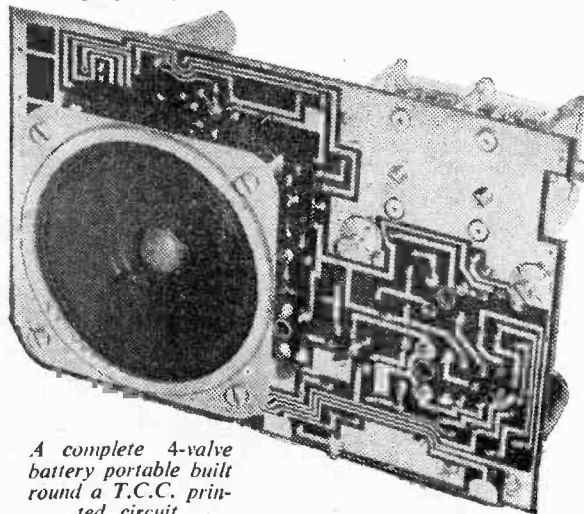

A complete 4-valve battery portable built round a T.C.C. printed circuit.

constructor, namely components. Unfortunately, as in recent years, the components stands have dwindled to a minimum. There are left only a few firms who specialise in components only, although a number of general manufacturers include separate parts among their many products. Bulgin, of course, still remain as the principal supplier of small parts, although they do not now include certain items which are used by the constructor.

Switches, plugs and jacks, and control knobs do, however, form the main part of the Bulgin exhibit and there is sufficient variety to enable any constructor to make up just the combination he desires. The all-important fixed condensers are now available in some most interesting types, which have enabled the overall size to be reduced to minute dimensions. These are available from T.C.C., Hunts and Eric, amongst others, and a most important feature of these small components is the inclusion of negative temperature coefficient condensers to prevent variations due to heating of chassis or air surrounding them. These firms also supply electrolytics

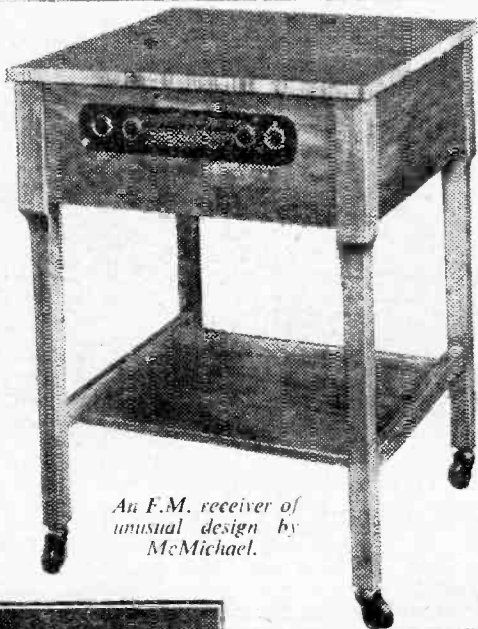

An F.M. receiver of unusual design by McMichael.

deners have also been produced to accommodate the surge which takes place on switching on some types of equipment. This is a very important point and is often overlooked by amateur set builders. A power pack utilising a 350-0-350 transformer with a valve rectifier can put out a voltage of 500 or more when first switched on and before the valves in the equipment have reached emitting temperature, and these "surge proof" condensers will assist in saving burnt-out rectifiers and other troubles.

Another interesting product is the range of rectifiers by Westinghouse (shown here) which are intended for bolting to a chassis, so that the large

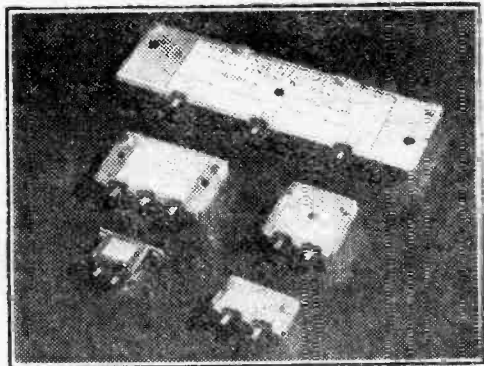

Contact-cooled rectifiers from the Westinghouse range.

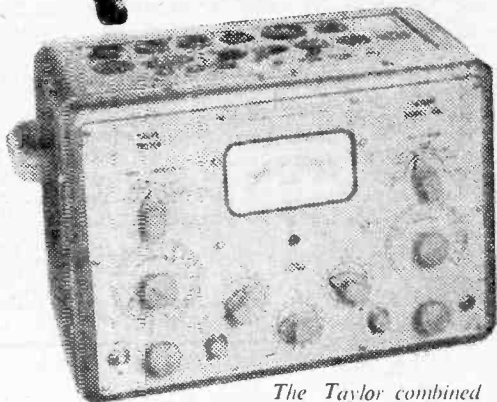

The Taylor combined valve tester and sweep oscillator.

of all types, and it is noteworthy that this year the overall dimensions of some of these have been reduced by the use of different materials for the plates. Quite small tubular electrolytics are now available, very little larger than some of the ordinary small capacity tubulars of former times, and special con-

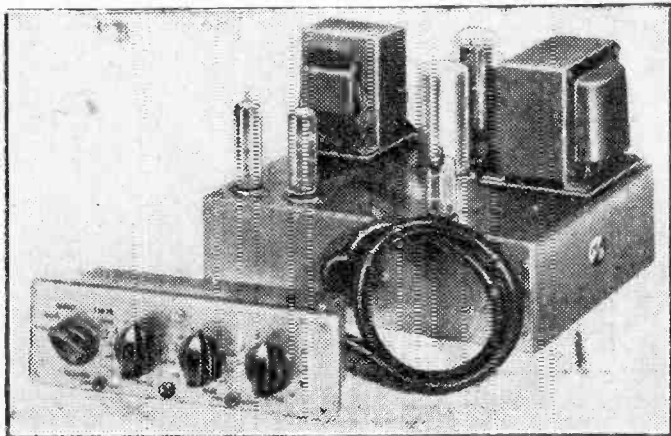

The new W.B. high-fidelity amplifier, WB12.

metal surface of the latter aids in keeping the rectifiers cool in use and thus avoiding the large fins to which we have become accustomed. Coils for the set maker will be shown by Wright & Weaire, who also supply various other components such as I.F. transformers, vibrators and mains transformers, etc.

Servicing Radio Receivers



5.—DOUBLE DECCA SERIES 51

By Gordon J. King, A.M.I.P.R.E.

SINCE its introduction before the war this most popular receiver has been manufactured in various forms, though mainly differing only from the circuit aspect. It is designed for use on either battery (these being self contained) or A.C./D.C. mains supplies; it features a built-in frame aerial and a short-wave band, making it an all-wave portable.

Apart from several circuit modifications, the series 51 differs from its older style counterparts by using the miniature type "all-dry" valves; formerly the octal type "all-dry" valves were employed.

On the battery position it obtains its power from an Ever Ready type B107, 90 volts high-tension, and an Ever Ready type all-dry 31, 7.5 volts low-tension. On the mains position both L.T. and H.T. are obtained from a half-wave selenium type metal rectifier.

The Circuit

The full circuit of the 51 series is shown in Fig. 1.

The section comprising the frame aerial L1, L3, L4 and associated capacitors, including trimmers T1 and T2 and the aerial and earth sockets, is built on the frame aerial support, which can be readily detached from the main chassis by unplugging. This section, showing the positions of the coils and trimmers, is depicted at Fig. 2. The connecting points A, B, C, D and E on the circuit indicate where the frame aerial section is connected to the aerial circuit through plugs and sockets; the plugs concerned are shown on Fig. 2.

The required aerial inductance is selected by switch S1A. On long-wave both loading coils L3 and L4 are included in the frame aerial circuit, whilst on medium-wave coil L4 is shorted and coil L3 by itself serves to load the frame aerial. On short-wave L1, L3 and L4 are shorted and the short-wave aerial coil L2 is brought into circuit. On this band, therefore, it is necessary to use an external aerial which is coupled to L2 through the 40 pF capacitor.

Switches S1B and S1C serve to select the required oscillator coils and need no further comment. It will be seen that the first and second grids of V1 heptode (DK91) are connected to the oscillator coils through 500 pF capacitors to form a conventional parallel-fed oscillator circuit.

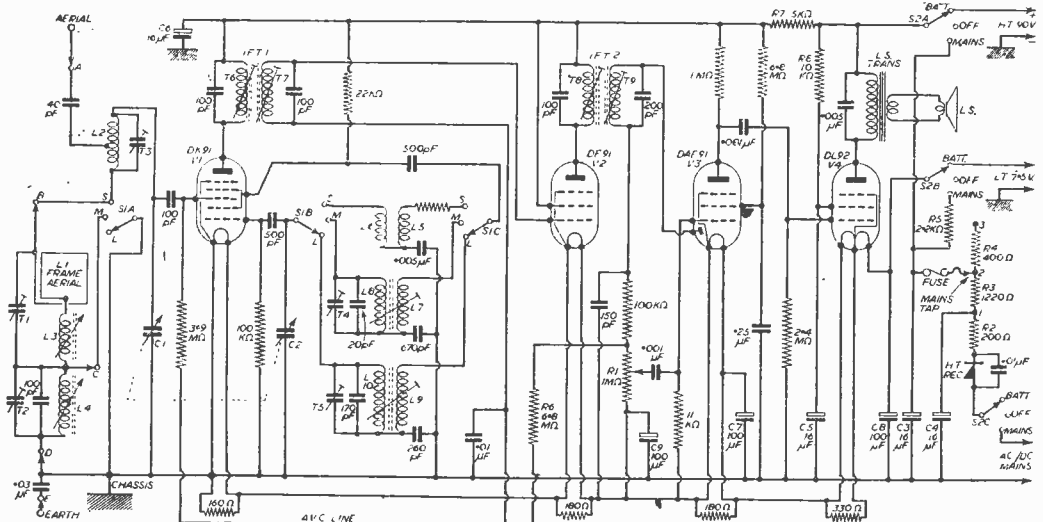

Fig. 1.—Circuit diagram of the Double Decca 51 series.

The aerial and oscillator circuits are variably tuned by the two-gang capacitor C1 C2, which is mechanically coupled to a slow-motion tuner.

The 380 kc/s I.F. signal developed in the anode of V1 is amplified by V2 (DF91) and fed to the signal diode of V3 (DAF91). The demodulated signal is thus fed in A.F. form from across the volume control R1 to the control grid of V3. The amplified A.F. in the anode is then passed on to the control grid of V4 (DL92). This valve being a power amplifier has the loudspeaker circuit connected in its anode.

A portion of the rectified I.F. signal is taken through R6 and used as an A.V.C. control bias for valves V1 and V2.

The filaments of the valves are connected in series to facilitate energising from a 50 mA D.C. line (each valve filament, of course, being rated at 50 mA) or a 7.5 volt battery. The various shunt resistors are included across the filaments to maintain correct voltage balance throughout the chain.

Switch S2 functions as battery-mains change-over and on/off. On the battery position, as shown, the L.T. and H.T. batteries are connected to the appropriate circuits in a straightforward manner. In the off position the H.T. and L.T. circuits are isolated. When positioned on mains switch S2C makes a connection from the mains to the H.T. rectifier, S2B connects the heater circuit to the top of R5, and S2A connects the H.T. line to the bottom of R5.

The value of R5 is chosen to provide a correct current in the valve filaments when the mains tapping is adjusted to correspond to the applied mains voltage: resistors R3 and R4 serve this purpose. Under this condition the correct H.T. line voltage will also exist at the bottom of R5. Tappings 1, 2 and 3 correspond to input voltages of 100-120, 200-220 and 230-250 respectively. It can thus be seen that R2 acts mainly as a limiter resistor and provides the desired voltage drop when the receiver is used on 100-120 volts.

H.T. smoothing is catered for by C3, C4, C6 and R7. Additional filtering is also provided by R3 and R4 when the mains tapping is set to the higher voltage position. The screen resistor R8 and capacitor C5 also aid in reducing the hum voltage in the output stage.

Since the all-dry type valves are directly heated, a residual H.T. line hum fed to the filaments would be extremely undesirable and would tend to give rise to a very disturbing hum from the loudspeaker. In order to avoid such an effect, therefore, substantial smoothing is applied to the L.T. circuit by the three 100 μ F capacitors C7, C8 and C9.

Servicing Notes

During the winter months particularly, one of the chief symptoms occurring on nearly all mains-battery portables when used on a mains supply is a gradual fade-out soon after the receiver is switched on. Routine testing quickly reveals that the oscillator has failed: this is proved, apart from employing more "classic" testing techniques, by the receiver exhibiting plenty of life (crackles) when the grids and anodes of the early valves are touched with a test prod.

After a while it is decided to try the receiver on batteries and all is well. The receiver is then probably again switched to mains and it may be decided to try substituting the DK91. This is a good move and likely to result in success. In a lot of cases, however, the success is not permanent, and often provokes a second examination at a later date.

Finally the H.T. rectifier is replaced and all seems well.

This symptom is unfortunately born of three factors. In the first place, the mains voltage, particularly during the winter months, when the system is heavily loaded, tends to fluctuate and reflects a reduction of current in the filament circuit and a consequent fall of voltage across the valve filaments. Secondly, the H.T. rectifier does tend to deteriorate progressively, but may not give rise to any undue effect provided the mains voltage is fairly stable. And thirdly, as will all valves, the DK91 also loses efficiency, probably aggravated by a fluctuating filament current, but rarely reveals its defect as a gradual loss of volume as is common with indirectly heated valves: in the case of the DK91 a sudden cut off generally indicates that its emission is insufficient to sustain oscillations.

Clearly, then, it is feasible that correcting only one of these factors may be sufficient to bring the set to life. It is a good idea to check the mains voltage both on site and in the workshop, and also to make sure that the mains voltage tapping corresponds to the applied voltage. It often happens that the receiver cuts off (i.e., stops oscillating) only at certain times (when the mains system is heavily loaded?). In most cases this means that either the mains tapping is incorrect or that the H.T. rectifier is in need of replacement. Not very often is it necessary to replace both the rectifier and the frequency changer (i.e., DK91).

In a similar respect it will be seen that the value of R5 is very important: this rarely increases in value, however; nevertheless, if it does the current in the filament circuit will probably be insufficient to sustain oscillation.

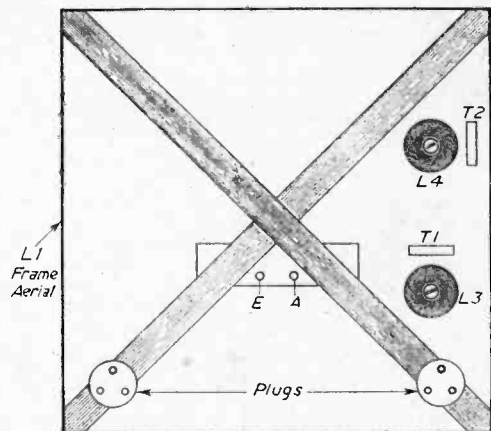

Fig. 2.—The frame aerial section, showing coils and trimmers.

Excessive distortion frequently crops up on this model; in the main it is caused either by the 0,001 μ F A.F. coupling capacitor becoming leaky or by the DAF91 anode load resistor (11 megohm) increasing in value. Less frequently the screen resistor of the same valve goes high in value and gives rise to a similar effect.

Low overall sensitivity is sometimes caused by one (or more) of the fixed I.F. transformer tuning capaci-

tors altering in value. The capacitor responsible is, however, quickly brought to light during the process of I.F. alignment, it being discovered that one or more of the I.F. tuning cores fail to peak within the range of normal adjustment.

Alignment Procedure

Initially, C2 on the tuning gang should be shorted and the gang set to maximum capacitance. The top core of the first I.F. transformer (I.F.T.1) should be completely removed.

The second I.F. transformer cores should be adjusted for maximum output (maximum indication on the output meter which may be connected across the primary of the speaker transformer) in virtue of a 380 kc/s modulated signal applied from the generator to the signal grid (pin 6) of V2. The lowest possible signal consistent with an output indication must be used.

Next, the tuning core should be replaced in I.F.T.1 and the generator signal applied to the signal grid (pin 6) of V1. The I.F. alignment is concluded by adjusting the cores in I.F.T.1 (T7 and T6) for maximum output, progressively reducing the signal input as the circuits approach alignment.

R.F. Alignment

Before adjusting the R.F. and oscillator trimmers it is essential to make certain that the tuning pointer is accurately positioned and coincides with the scale cursor line.

Inject a 15 Mc/s signal into the aerial and earth sockets and tune the receiver over the short-wave band until it is indicated on the output meter. Adjust the short-wave aerial trimmer T3 (Fig. 3) for maximum output while adjusting the receiver's tuning slightly either side of the signal (this process is generally known as "rocking the gang").

Adjust the receiver to 500 metres (medium-wave), tune the generator to 600 kc/s and very loosely couple its output to the frame aerial (do not make an electrical connection). Tune the core in the medium-wave oscillator coil L7/8 (Fig. 4) for maximum output.

Retune the receiver and generator to 200 metres and 1,500 kc/s respectively and tune the medium-wave oscillator trimmer T4 (Fig. 3) for maximum output.

Adjust the medium-wave aerial trimmer T1 (Fig. 2) for maximum output. Finally, repeat the above process until maximum sensitivity and minimum tracking error exist.

Adjust the receiver to 2,000 metres and the generator to 150 kc/s and tune the core of the long-wave oscillator coil L9/10 (Fig. 4) for maximum output.

Tune the core of the long-wave loading coil L4 (Fig. 2) for maximum output.

Retune the receiver and generator to 1,200 metres and 250 kc/s respectively and adjust the long-wave oscillator trimmer T5 (Fig. 3) for maximum output.

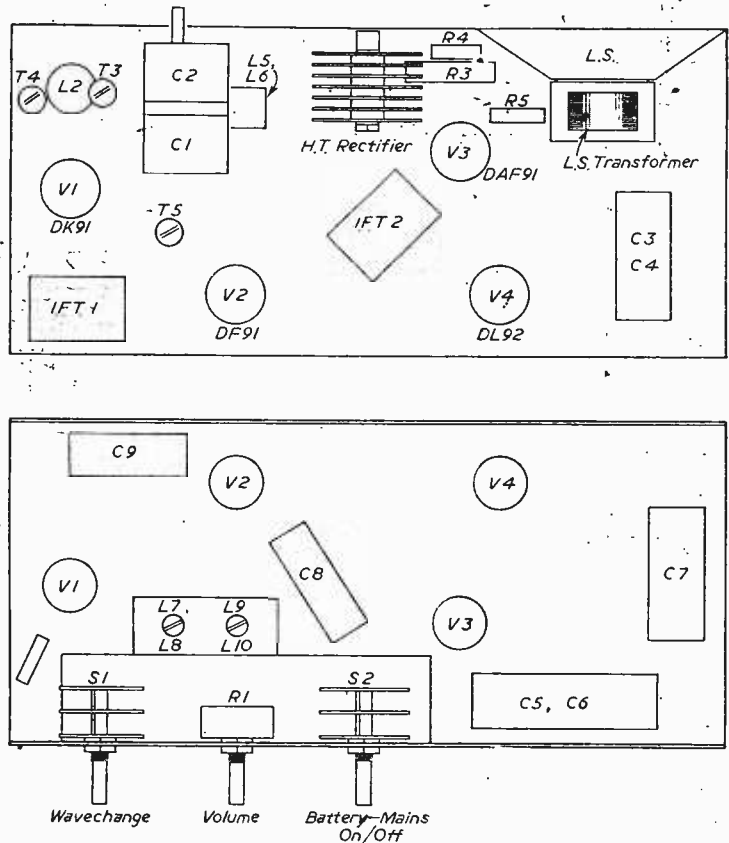

Fig. 3 (above).—Top view of the chassis, showing the positions of the valves, etc. Fig. 4 (below).—Underside view of the chassis.

Tune the long-wave aerial trimmer T2 (Fig. 2) for maximum output.

Finally, repeat the process for optimum sensitivity and minimum tracking error.

Notes

In order to avoid alignment error as the result of the action of the A.V.C. system the generator output voltage should be kept to the minimum possible to provide readable deflection on the output meter.

If low sensitivity at the low-frequency end of the medium-wave band is experienced the core in L3 (Fig. 2) should be adjusted for maximum output at 500 metres (600 kc/s).

PIFCO RADIOMETER

The price of the Pifco All-in-One Radiometer has been increased to 32/6d. complete.

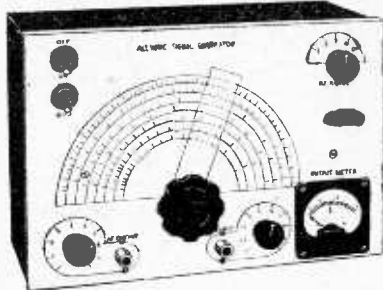

COMpletely BUILT SIGNAL GENERATOR

Coverage 120 Kc/s-320 Kc/s, 300 Kc/s-900 Kc/s, 900 Kc/s-2.75 Mc/s, 2.75 Mc/s-8.5 Mc/s, 8 Mc/s-28 Mc/s, 16 Mc/s-56 Mc/s, 24 Mc/s-84 Mc/s. Metal case 10in. x 6 1/2in. x 4 1/2in. Size of scale, 6 1/2in. x 3 1/2in. 2 valves and rectifier. A.C. mains 230-250 v. Internal modulation of 40% c.p.s. to a depth of 30 per cent., modulated or unmodulated R.F. output continuously variable 100 milli-volts. C.W. and mod. switch, variable A.F. output and moving coil output meter. Black crackle finished case and white panel. Accuracy plus or minus 2%. £4/19/6 or 34/- deposit and 3 monthly payments 25/- P. & P. 4/- extra.

Heater Transformer. Pri. 230-250 v. 6 v. 1 1/2 amp., 6/-; 2 v. 24 amp., 5/-.

Three-speed automatic changer, B.S.R., current model. Will take 7in., 10in. or 12in. records mixed. Turn-over crystal head, cream finish. VERY LIMITED QUANTITY A.C. mains 200/250. £7/19/6. P. & P. 4/6.

T.V. CONVERTER for the new commercial stations, complete with 2 valves. Frequency can be set to any channel within the 180-196 Mc/s band. I.F. will work into any existing T.V. receiver between 42-68 Mc/s. Input arranged for 80 ohm feeder. EF80 as R.F. amplifier, ECC81 as local oscillator and mixer. The gain of the first stage, R.F. amplifier 10DB. Required power supply of 200 D.C. at 25 mA., 6.3 v. A.C. at 0.6 amp. Input filter ensuring freedom from unwanted signals. Simple adjustments only, no instruments required for trimming. Will work into any T.R.F. or Superhet. Size 4 1/2 x 2 1/2 x 2in. P. & P. 2/6. £2/19/6.

Double Wound Mains Transformer, 200/250 v. metal rectifier, and smoothing condenser to suit above, 18/6.

Extension Speaker cabinet in polished walnut, complete with 8in. P.M. P. & P. 3/-, 24/6.

8in. P.M. Speakers, removed from chassis, fully guaranteed. All by famous manufacturers. P. & P. 1/6. 12/6.

Volume Controls. Long spindle less switch, 50 K., 500 K., 1 meg., 2/6 each. P. & P. 3d. each.

Used A.C. Mains 200/250 volts, 4-valve plus Metal Rectifier, medium wave superhet in polished walnut cabinet, size 14 x 9 1/2 x 7 1/2in., complete with valves 6X8, 6X7, 6Q7 and 6F6, 6; PM speaker. Fully guaranteed. P. & P. 7/6. £3 15/-.

Constructor's Parcel: Medium & Long-Wave A.C. Mains 230/250 2-valve plus Metal Rectifier, 22/6. Comprising chassis 10 1/2 x 4 1/2 x 1 1/2in., 2 waveband scale, tuning condenser, wavechange switch, volume-control, heater trans., metal rectifier, 2 valves and w/holders, smoothing and bias condensers, resistors and small condensers, and medium- and long-wave coil, Iitz wound. Circuit and point-to-point, 1/3. Post and Packing, 2/6 extra.

Volume Controls. Long spindle and switch, 1, 1 1/2, 1 and 2 meg., 4/- each, 10 K. and 50 K. 3/6 each. 1 and 1 meg., long spindle, double pole switch, miniature, 5/-.

Standard Wave-change Switches, 4-pole 3-way, 1/9; 5-pole 3-way, 1/9. Miniature 3-pole 4-way, 4-pole 3-way, 2/6. 2-pole 11-way twin wave, 5/-; 1-pole 12-way single wafer, 5/-.

40-Watt Fluorescent Kit, A.C. Mains 230-240. Comprising choke, power-factor condenser, 2 tube holders, starter and starter-holder. P. & P. 3/-, 17/6.
20 watt A.C. or D.C. 200/250 v. fluorescent kit, comprising trough in white-stoved enamel, two tubeholders, starter, holder and barretter. P. & P. 1/6. 12/6.

1200ft. High impedance recording tape on aluminium spool, 12/6 post paid.

Polishing attachment for electric drills. Quarter-inch spindle, chromium-plated, 5in. brush, 3 polishing cloths and one sheep-skin mop, mounted on a 3in. rubber cup. P. & P., 1/6. 12/6. Spare sheep-skin mops, 2/6 each.

Potato & Vegetable Peeler, by famous manufacturer, capacity 4 1/2lbs., complete with water pump. All aluminium construction, white stove-enamel finish. Originally intended for adaptation on an electric food-mixer, can easily be converted for hand operation. 39/6. P. & P. 3/-.

R. & T.V. COMPONENTS (ACTON) LTD.

23, HIGH STREET, ACTON, LONDON, W.3

PERMEABILITY TUNED T.V. CONVERTER
for new commercial stations



Input 300 ohm balanced line or 80 ohm coax. Coverage 180-200 Mc/s-Vision I.F. —10.7 Mc/s. Valve line-up 6AK5 R.F. amplifier, 6AK5 mixer, 6C4 separate oscillator. This is a high gain unit, ideal for fringe areas. Can also be used as **FM TUNER**. Frequency coverage 80-100 Mc/s. I.F. 10.7 Mc/s. Size 9in. wide, 6 1/2in. deep, 4 1/2in. high, 9in. scale, width including overlap 14in. Complete with 3 valves. P. & P. 3/-, 24/9/6.
10.7 Mc/s I.F.'s to suit above, 4/6 each.



Complete A.C. Mains 3 Valve plus metal rectifier T.R.F. kit. In the above cabinet, £3/15/0, plus 3/6 P. & P.

PLASTIC CABINET as illustrated, 11 1/2 x 6 1/2 x 5 1/2in., in walnut or cream. ALSO IN POLISHED WALNUT, complete, with T.R.F. chassis, 2 waveband scale, station names, new waveband, back-plate, drum, pointer, spring, drive spindle, 3 knobs and back, 22/6. P. & P. 3/6.

As above with Superhet Chassis, 23/6. P. & P. 3/6.
As above complete with new 5in. speaker to fit and O.P. trans., 40/-, P. & P. 3/6. With Superhet Chassis, P. & P. 3/6. 41/-.

Used Metal Rectifier, 230 v. 50 mA., 3/6; gang-with trimmers, 6/6; M. & L. T.R.F. coils, 5/-; 3 Govt. valves, 3 v/h and circuit, 4/-; heater trans., 6/-; volume control with switch, 3/6; wave-change switch, 2/-; 32 x 32 mfd., 4/-; bias condenser, 1/-; resistor kit, 2/-; condenser kit, 4/-.

Single speed player, A.C. mains 200/250 volt, complete with needle armature pick-up in a really wonderful polished walnut cabinet, will take up to 12 inch record. Pull-out drawer on steel runners. Original list price £8/17/6, our price £4/19/6, post and packing 10/-.

P.M. SPEAKERS, 6 1/2in. closed field, 18/6, 8in. closed field, 20/6, 10in. closed field, 25/-, 3 1/2in., 16/6. P. & P. on each, 2/-.

Valveholders, Paxolin octal, 4d. Moulded octal, 7d. EF50, 7d. Moulded BTG, 7d. Loctal amphenol, 7d. Loctal pak, 7d. Mazda Amp., 7d. Mazda pak, 4d. 8BA, 8BA amphenol, 7d. BTG with screening can, 1/6. Duodecal packin, 9d.

Twin-gang, .0005 Tuning Condensers, 5/-, With trimmers, 6/6.

CUB one-sixth h.p. A.C. 220/230 v. by Brook Motors. Reversible for continuous running, £4/9/6. Post & Pkg., 7/6.

Primary, 200-250 v. P. & P. 2/-.
500-0-500 120 mA. 4 v. C.T. 4 a. 4 v. C.T. 2.5 a., 27/6.
500-0-500 250 mA. 4 v. C.T. 5 a. 4 v. C.T. 5 a. 4 v. C.T. 4 a., 39/6.
300-0-300 100 mA., 6 v. 3 amp., 5 v. 2 amp., 22/6.
Drop thro' 350-0-350 v. 70 mA., 6 v. 2.5 amp., 5 v. 2 amp., 14/6.
Drop thro' 250-0-250 v. 80 mA., 6 v. 3 amp., 5 v. 2 amp., 14/6.
230-0-230, drop through, 80 mA., 6 v. 3 amp., 5 v. 2 amp., 14/6.
250-0-250, 80 mA., 6 v. 3 amp., 14/-.
Drop thro' 270-0-270 60 mA., 6 v. 3 amp., 4 v. 1.5 amp., 13/6.
Drop thro' 270-0-270 60 mA., 6 v. 3 amp., 11/6.
Auto Trans. Input 200/250. H.T. 350 v. 350 mA. Separate L.T. 6.3 v. 7 a., 6.3 v. 1 1/2 amp., 5 v. 3 amp., 25/-, P. & P. 3/-.

32 mfd., 350 wkg.	2/-	16 + 16 mfd., 350 wkg.	3/3
16 x 24 350 wkg.	4/-	60 + 100 mfd., 280 v. wkg.	7/-
4 mfd., 200 wkg.	1/3	50 mfd., 180 wkg.	1/8
40 mfd., 450 wkg.	3/6	65 mfd., 220 wkg.	1/6
16 x 8 mfd., 500 wkg.	4/6	8 mfd., 150 wkg.	1/6
16 x 16 mfd., 500 wkg.	5/9	50 mfd., 12 wkg.	11d.
16 x 16 mfd., 450 wkg.	3/9	50 mfd., 10 wkg.	1/9
32 x 32 mfd., 350 wkg.	4/-	Miniature wire ends	
25 mfd., 25 wkg.	11d.	moulded 100 pl., 500 pl.,	
250 mfd., 12 v. wkg.	1/3	and 001 ea.	7d.
16 mfd., 500 wkg. wire	1/3	280-0-280 80 mA. 4 v. 4 a.,	
ends....	1/3	4 v. 2 a.	14/6
8 mfd., 500 v. wkg., wire	2/6	250 v. 350 mA. 6.3 v. 4 a.	
ends....	2/6	twice, 2 v. 2 a.	19/6
8 mfd., 350 v. wkg., tag	1/6	Auto-trans. Input 200/250	
ends....	1/6	HT 500 v. 250 mA. 6 v.	
100 mfd., 350 wkg.	4/-	4 a. twice 2 v. 2 a.	19/6

Where post and packing charge is not stated, please add 1/6 up to 10/-, 2/- up to £1 and 2/6 up to £2. All enquiries S.A.E. Lists 5d. each.

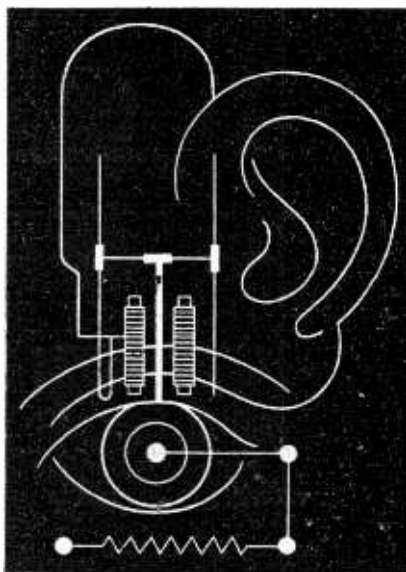

SMITH'S FOR TECHNICAL BOOKS

Books on radio theory, practice and maintenance for the beginner and books on new developments in circuit design, new components, methods of application, and the established text books can be obtained through your local Smith's shop or book-stall. Books not in stock at the branch can be quickly obtained from Head Office.

★ Your stationery and printed matter can also be supplied through our local branch.

W. H. SMITH & SON

FOR BOOKS ON ELECTRONICS

Head Office: STRAND HOUSE, LONDON, W.C.2

RADIO/RADIOGRAM CHASSIS

BUILT TO
HIGHEST TECHNICAL STANDARDS
NEW RANGE OF MODELS WITH LATEST FEATURES
FERRITE ROD AERIAL
MINIATURE (BVA) VALVES, STEEL CHASSIS
3 WAVEBANDS, A.C. MAINS, 200/250 VOLTS
ASSEMBLED AND READY FOR USE. FULLY GUARANTEED

Model F.3. 5 Valves chassis, 4 watt output. Wide range tone control.

Model F.3. Push-Pull chassis. 7 valves, 6 watt output, separate bass and treble controls.

Size 12" x 7"
x 7 1/2" high.

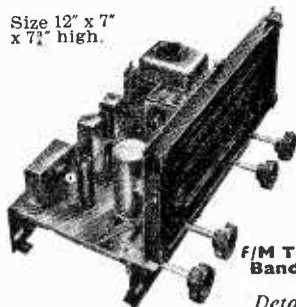

Negative feedback applied from output transformer secondary. Gram switching on wave-change switch. Plug-in connections for pick-up, speaker, gram motor.

**Manufacturers of
Tape Recorders.
Amplifiers for Tape
Recorders.
Crystal Receivers as
Tuner Units.
F/M Tuners (Self powered)
Band III T.V. Converters.**

Detailed list and dimensions

DIRECT FROM THE MANUFACTURER
THE DULCI CO. LTD.

99 VILLIERS ROAD, LONDON, N.W.2.
Telephone: WILlesden 6678

A fine selection from

The Walk-around Shop

JUST RELEASED. 2 METRE RECEIVER

Type 1392. Air Tested 15 Valve Superhet. Frequency 95-150 Mc/s (2-3 metres). Slow-motion tuning over 95-150 Mc/s or can be Crystal controlled. Power supply required: 240-250 v. at 80 mA, 6.3 v. at 4 a. Size: 19in. x 10in. x 10in. Standard rack mounting. **PRICE £6.19.6.** Complete with valves and circuit diagrams. Pkg. & Pstg., 17/6. 10/- returnable on packing case. Note: Type 234 Power Pack for above is available. **Price £3.10.0.** Pkg. & Pstg., 7/6.

RECEIVER Type 1132. 11 Valve Superhet. Frequency coverage 100-125 Mc/s. Switchable A.G.C. & A.V.C. Variable B.F.O. Circuit diagrams with units. Easily converted to cover Wrotham Band. No alteration to wiring required. Conversion Slugs and instructions 5/- extra. Size: 19in. x 10in. x 10in. Standard rack mounting. **PRICE £3.7.6.** Pkg. & Pstg., 15/-. 10/- returnable on packing case. Note: Type 3 Power Pack is available for above. **Price £2.5.0.** Pkg. & Pstg., 7/6.

INDICATORS Type 62a. Ideal for conversion to Oscilloscopes, T.V. Units, etc. Containing VCR97, 12 VR91 (EF50), 2 VR54 (EB34), 3 VR92 (EA50), 4 CV118. Slow-motion dial. 13 pots and scores of useful components. Size: 8 1/2in. x 11 1/2in. x 18in. New. In wooden packing case, **PRICE £3.10.0.** Crg., 7/6.

DINGHY TRANSMITTERS BC788. American manufacture. In new condition. Comprising: 12A6, 12SC7 valves. Excellent hand generator (can be used as a Mains A.C. motor) with extensive change of gears, plus a quantity of useful radio components. Bargain **PRICE £1.** Pkg. & Pstg., 10/-.

F.L.8a FILTERS. Splendid value. **Price 10/6.** Pkg. & Pstg., 1/6.

R.F. UNITS. RF24, 20-30 Mc/s. RF25, 40-50 Mc/s, both valved and with switched tuning. **Price 9/6 each.** Pkg. & Pstg., 2/-.

RF26, 50-65 Mc/s variable tuning. (Dials damaged) **Price 15/-.** Pkg & Pstg., 2/-.

NOTE: Orders and enquiries to Dept. "P."

PROOPS BROS. LTD. Telephone LANGham 0141
52 Tottenham Court Road, London, W.1.
Shop Hours: 9-6 p.m. Thursday: 9-1 p.m. Open all day Saturday.



On Your Wavelength

BY THERMION

Midget Sets

MY paragraph inviting readers to send in details of any really midget receivers they have made has brought forth a design from Mr. E. R. Beney, of Neatishead.

It really is a midget, and makes use of three Mullard Junction type P.N.P. transistors. His aim was to produce a small personal earphone receiver for use out of doors, and to give comfortable listening output signals on the Midland Medium wavelength and the Light Long wavelength. The set does fulfil this limited aim and very much more. Its size including phone jack, but excluding earphones and batteries, is 4½ in. by 4 in. by ¾ in. deep. It is permanently tuned to each of the two wavelengths, the choice of which is by means of a changeover switch, but trimming to allow for variations of aerial-earth system in use is by means of adjustable coil cores. Adequate signal strength is given on both wavelengths with a short earth wire only, and no aerial wire, the telephone leads apparently providing sufficient pick-up.

With a normal size aerial and earth system, good loudspeaker results are obtained, and a midget variable resistance is included in the aerial circuit to control this output which at times, he tells me, is strong enough to produce distortion. These midget transistors are, of course, easily overloaded.

Because the total current consumption is under 1 mA, the battery (4½ volts with 4½ volts bias) can be of quite minute dimensions, but because so far as is known the makers of the layer-type hearing aid batteries have not yet marketed one containing six cells only (which is all that is wanted), Mr. Beney made up his battery from six U-16 dry cells and its dimensions including a Clix three-pin socket is 3 in. by 1½ in. by ½ in., a negligible bulk for pocket use. All components are standard equipment except the coils, which Osmor wound specially for him.

I should still be interested to have details of any other midget receivers which have been constructed and successfully demonstrated by readers.

Radio and Space Travel

THE interest now being shown in space travel as a result of the announcements by America, Great Britain and Russia, has created an interest in the special equipment which will be necessary for the artificial satellites to transmit messages back to the earth. Radio is bound to play a large part in interplanetary travel and it is possible that the technical data which results from its use will have a beneficial effect on radio design.

It seems likely that the first journeys to the moon will be made by robots and not by human beings. The robots, who will be the mechanical passengers, will, by means of radio transmission, keep the earth informed of what is happening and they will also guide the craft.

It seems reasonably certain that such craft will land on the moon within the next 20 years. Such a

project is far less fantastic than the idea of television was thought to be in its early days. Indeed, the main difficulty seems to be to find the money.

Radio-controlled Models

INTEREST in radio-controlled models of all descriptions continues to advance. The hobby now has an important and well-conducted association to co-ordinate interest in the subject, and members are contributing valuable articles on the subject to *Practical Mechanics* each month.

The International Radio Exhibition

IN 1922, on September 2nd to be precise, the International Radio Exhibition and Wireless Convention was opened at the Central Hall, Westminster, almost exactly 33 years ago. The method of opening was then considered to be unique. A mile away at the Air Ministry Brig.-Gen. Sir W. S. Brancker gave the opening speech which was radiated by wireless and then broadcast throughout the Hall. In the course of his speech he said that "wireless had come into its own and was largely responsible for the upkeep of the British Empire."

Major L'Estrange Malone, M.P., in the course of his reply, advised the radio trade not to overdo the boom in wireless. He suggested that manufacturers should take care that no monopoly was set up for the providing of apparatus, and that they should form some kind of protection society to look after their interests, so as to get the maximum benefit for the trade.

A speaker proposing the success of the Exhibition said that he hoped it was the first of many more to come. This was, of course, the very first Radio Show and I often wonder what some of those early pioneers must think when they visit the Radio Exhibition at Earls Court to-day.

The control of mechanism by wireless was demonstrated at that exhibition by Major Raymond Phillips, who prophesied then that it "would undoubtedly lead to a big thing."

"On Your Wavelength"—33 Years Old

THIS feature first saw the light of print in *Amateur Wireless*, dated November 18th, 1922. It regularly appeared until the paper died and became merged with PRACTICAL WIRELESS, which for a time appeared under the title *Practical and Amateur Wireless*.

Thus, "Thermion" has continuously appeared for 33 years. His postbag to-day is as large and as varied as ever, brickbats and bouquets being regularly received in assorted quantities. I can fairly claim to be the first radio journalist properly so described for I was contributing articles on radio to "Hobbies," "Everyday Science," "Work" and other journals many years before there were any radio journals.

There have been many speculations during these years as to my identity, which has been a well-preserved secret.

TRANSMITTING TOPICS

LOADED AERIALS FOR TOPBAND

By O. J. Russell, B.Sc.(Hons.), G3BHJ

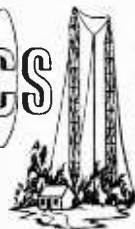

CORRESPONDENCE has shown that there is a very great interest in the question of loaded aerials for topband use. This interest is not unnaturally greatest among the citybound amateurs who are anxious to improve the radiation efficiency of their installation upon topband. In view of the fact that a 10-watt topband transmitter may be reduced to the level of a transistor QRP rig by an inefficient aerial, attention to the topband aerial system is in order. As previously stated, the actual earth resistance is an integral part of the Marconi system, and every effort to obtain a really low resistance earth is necessary, including the provision of multiple earth rods spaced over the ground area available. It will be assumed that a really low-resistance earth system can be achieved. An earth resistance of 10 ohms represents a good earth effective resistance, and this value will be assumed.

Where multiple earths are in existence, the amateur can readily determine the resistance value by measurements. The use of a resistance meter, such as an AVO meter on the low-resistance range is satisfactory, if only a brief reading is taken. The meter should not be connected longer than is necessary, as polarisation effects may occur due to soil electrolysis. The simple A.C. bridges available will enable resistance readings to be taken without trouble from polarisation effects. However, a "spot" reading with the usual multimeter on its resistance range will enable sufficiently accurate measurements to be made.

Fig. 1 shows the set-up necessary for earth resistance measurements. Three separate earth connections are required, as the return connection to any earth rod can only be effected by using a

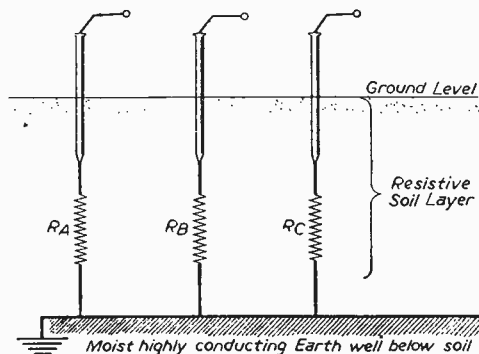

Fig. 1.—The arrangement necessary for measuring earth resistance.

further earth rod as the return. As the resistance of the earth rod is, initially, unknown, the actual earth resistance must be calculated from cross measure-

ments made on the three earthed rods. Four or more earthed rods may be employed, and in this case alternative checks can be obtained from the resistance figures.

Earth Rod

Referring to Fig. 1, it is assumed that each earth rod has an unknown resistance connected to an ideal buried earth under the soil of zero resistance. Thus the resistance of Rod A is R_A , of Rod B is R_B and of Rod C, R_C . The resistance measured from Rod A to Rod B is thus R_A plus R_B , and so on for the three possible pairs of earth rod connections. Let the measured values of resistance be X , Y and Z , so that we have:—

$$\begin{aligned} X &= R_A + R_B \\ Y &= R_A + R_C \\ Z &= R_B + R_C \end{aligned}$$

The following simple algebraic manipulation enables the values of all the resistances to be determined. First of all add X and Y . This gives us $X + Y = 2R_A + R_B + R_C$. However as $Z = R_B + R_C$, we have only to subtract Z to determine R_A . Thus $X + Y - Z = 2R_A$. In other words we have now $R_A = \frac{1}{2}(X + Y - Z)$. Thus having determined R_A , we can find the values of the other resistances in turn by using the value of R_A to find R_B , and then using the value of R_B to determine R_C .

A numerical example may help those whose algebra is a little rusty. Thus in one case X was 25 ohms, Y was 30 ohms and Z 35 ohms. Hence R_A was $\frac{1}{2}(25 + 30 - 35)$ ohms, that is $\frac{1}{2}(55 - 35)$ ohms = $\frac{1}{2}(20)$ ohms = 10 ohms. As Y is R_A plus R_C and we now know R_A is 10 ohms, clearly as Y is 30 ohms, then R_C must be 20 ohms. Similarly as $Z = R_B$ plus $R_C = 35$ ohms, and we now know R_C is 20 ohms, then clearly R_B must be 15 ohms in value. As earth resistance values from 10 ohms up to 50 ohms may be encountered in practice, figures of the above order will be obtained on resistance meter tests. Three average-to-good garden earths of say 30 ohms apiece, if paralleled, will give a final effective earth resistance of 10 ohms, so that it really is necessary to employ at least three widely spaced garden earth rods if a satisfactorily low earth resistance is to be achieved! To make a reasonable earth, several feet of copper rod or tube should be driven into the soil. Six to 10ft. is about the minimum, and even greater depths are desirable. It should be noted that the efficiency of an earth connection to the waterpipes can be readily checked by the resistance method. All that is needed is the provision of two auxiliary earths, so that the requisite three resistance readings can be taken. A few tests with a resistance meter may provide a few shocks for those amateurs who have assumed that their earth connections are above suspicion. It may also provide a clue to those missing topband contacts, and the solution is obvious!

While it may seem paradoxical to devote attention to the *earth* as a part of the aerial system, it should be noted that generally this is a very much neglected part of the Marconi type of topband aerial. Moreover it represents a major source of loss that must be attended to if improvements elsewhere are to be worth-while. Thus an 8ft. whip aerial on topband has a radiation resistance of 1/10 of an ohm, so that even with an earth resistance of 10 ohms.

ohms, so that with an earth resistance of 10 ohms, the radiation resistance of 1/10th of an ohm now represents an efficiency of less than 1/100 of 1 per cent. Should we build a coil with a Q of 100, this will have a resistance of 40 ohms, so that our overall figure would become one fifth of 1 per cent.

The contention that "every foot of height counts" is borne out by the fact that a 40ft. vertical only requires a coil of about quarter the inductance, and hence (for the same Q value) of one quarter the effective series resistance. Thus, with a Q of 300 this means approximately 3 ohms of coil resistance. Also the radiation resistance of the 40ft. vertical is 2 ohms, so that with a coil resistance of 3 ohms, and an earth resistance of 10 ohms, we have 13 ohms of wasteful resistance in series with the 2 ohms of useful radiation resistance of the aerial. Thus, 2/15th of the total R.F. power will be radiated, an efficiency of some 13.3 per cent. This is a vast improvement over the 1/10 per cent. possible with an 8ft. whip using the best coil we can make!

The lesson is obvious. After we have installed multiple earths to reduce earth resistance to the lowest practicable level, we must think in terms of ceramic coil formers and thick wire. Number 14 or even 12 gauge wire, spaced by approximately the wire diameter on a low-loss former, or self supported, is necessary for obtaining high values of Q. Optimum Q values are obtained when the length to diameter ratio is approximately two, and long coils of small diameter should not be used.

Fig. 2 shows the typical base-loaded antenna set-up, and Fig. 3 gives the approximate radiation efficiency with coils of various Q values, with an assumed earth resistance of 10 ohms. What is startling, is that efficiency may vary over a range of some 300 to 1 when considering aerials ranging from an 8ft. whip loaded by a coil of Q=50, up to a 64ft. aerial with a high Q coil of Q=300. However, even a change from a 16ft. vertical to a 24ft. vertical can make nearly an S point (four-to-one power change) difference. This is a welcome bonus for a mere 8ft. of height increase. While the curves are derived from approximate calculations they should serve to highlight the necessity for extreme care in loading up an aerial for topband. Obviously a makeshift aerial system is unlikely to be efficient. Also, of course, the actual aerial wire itself is relatively unimportant in view of the huge losses that can be introduced by the earthing system and by the loading coil system. Moreover, these losses are "hidden" losses, as even a high-resistance earth and a poor loading coil will tune up in what appears to be a normal fashion.

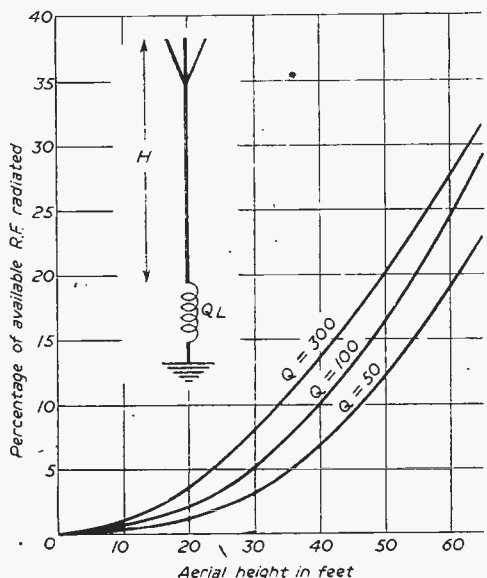

Fig. 3.—Efficiency of vertical aerials on topband. The curves show the percentage of R.F. radiated for loading coils of various Q values, and a ground resistance of 10 ohms.

and with a perfect loading coil the efficiency is only 1 per cent., so that a typical 10-watt rig supplying 7 watts of R.F. to the whip would actually result in the radiation of only .07 watts of R.F., that is 70 milliwatts! Even in the case of a 32ft. vertical, the radiation resistance is only 2 ohms or so, so that with a 10 ohm earth resistance, only 17 per cent. of the R.F. available is radiated, so that our typical 10-watt rig would only radiate about 1.2 watts. However, this is a vast improvement, some 12 db, or two S points above the 8ft. whip case. Increasing the aerial to a 60ft. vertical would add another S point.

Loading Coil

However, these figures assume a perfect loading coil of zero resistance. Practically, of course, a loading coil has a definite R.F. resistance. As shown in the April, 1955, issue of this journal, the aerial radiation resistance, the earth resistance and the loading coil resistance are all in series, so that the reduction of earth and coil resistances is essential for efficiency. Unfortunately, in the case of coils we are unlikely to exceed a Q figure of 300 even by using 14 gauge wire on a ceramic former. For the 8ft. whip, a base loading coil of 350 microhenries (approximately) is required. A really high Q design of loading coil with a Q of 300, has an effective R.F. resistance of 14

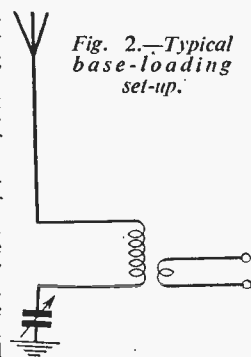

Fig. 2.—Typical base-loading set-up.

Base-loading Coil

As explained previously, the function of the base-loading coil is to tune the effective capacity of the aerial to resonance, so that power may be loaded into the aerial. The capacity of the aerial varies with the wire diameter slightly. Thick aerials have slightly

more capacity than thin wires. Fig. 4 shows the approximate capacity of short vertical aerials made of wire, that is "thin" aerials. The approximate inductance required to load these aerials at the base for resonance in the topband is shown in Fig. 5. In practice, of course, a series aerial tuning condenser is often employed to adjust the "effective inductance" of the loading coil to exact resonance. This obviates any difficulty with taps on the coil, or with unused turns. Even with the low power of 10 watts, high circulating currents and high R.F. voltages are developed across the loading coil and the loading condenser. It is, in fact, the high currents circulating that cause appreciable losses with even high Q loading coils. The fact that a neon lamp lights brightly when placed on the loading coil or series resonating condenser is heart-warming to the true amateur. Unfortunately, it is also literally a "red light" warning of the high losses inevitable with Marconi-type systems, unless every precaution is taken to reduce sources of R.F. loss in every element of the aerial system.

An Example

A true story illustrates this. In the shack of a well-known topband exponent, an emergency loading coil was wound with enamel wire on a cardboard former. After some tinkering to load up the aerial system on topband, satisfactory results were obtained. After an interval for tea and refreshment, a return was made to the shack, where it was found that the aerial current was greatly down, and a local contact reported a much-reduced signal strength. In the course of the QSO, the aerial current slowly crept back to its original value, and the signals were reported increasing in signal strength. The cardboard former was then found to be appreciably warm. The solution was that the cardboard had

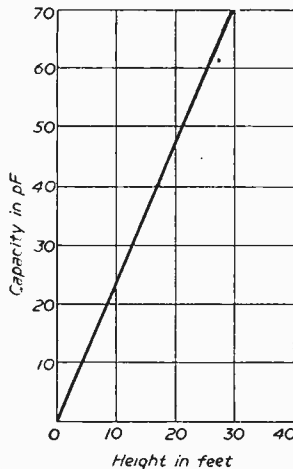

absorbed atmospheric moisture, and its R.F. losses had sharply increased during the interval for tea. The heat dissipated due to

Fig. 4.—Approximate capacity of vertical wire aerials.

the losses automatically dried out the cardboard during the QSO, so that the losses decreased, with a consequent rise in aerial current and radiated signal! It is needless to add that the temporary coil was rapidly substituted by a coil wound with thicker wire on a ceramic former!

While a cardboard former is unlikely to be used for a permanent topband loading coil, it is a graphic example of the dramatic improvement possible by the reduction of losses. While it may seem reminiscent of 1920 practice to use heavy wire and large ceramic formers, it should be remembered that the topband

is truly the "long-waveband," and to amateurs in restricted locations it offers a severe problem from the aerial point of view. Those fortunate enough to

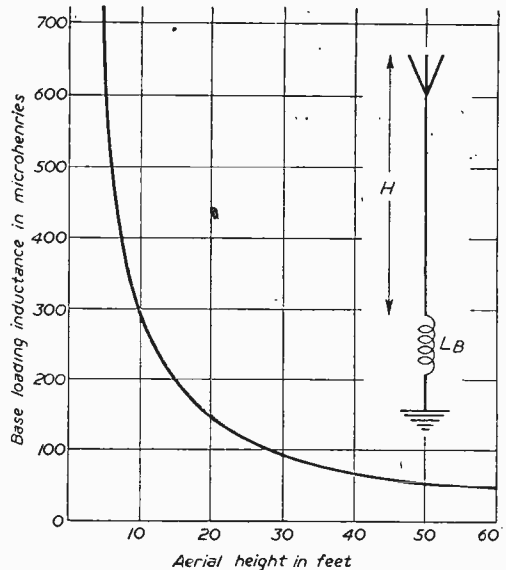

Fig. 5.—Approximate inductance values for resonating vertical aerials to the topband. In practice, slightly larger coils should be used and resonated by the usual series condenser.

have ample space for long wires and high masts are the fortunate few indeed as far as topband is concerned. Even here, however, if a Marconi system, such as a 132ft. against ground is used, the earth resistance is still important. Radiation efficiency with a 30 ohm ground resistance means only 40 per cent. of the power is radiated. Also if most of the 132 ft. is horizontal, efficiency may be much lower still, a factor that may be considered in a later article, as height rather than length is the important factor in topband aerials.

"PRACTICAL TELEVISION" SEPTEMBER ISSUE

Now on Sale, Price 1/-

The September issue of *Practical Television* contains details for making a Fringe Area Band III Converter and also the third article in the short series on "Receiving the I.T.A."

Also contained in the issue is a preview of some of the exhibits at the National Radio Show, an article entitled "Inlay and Overlay" which deals with the interesting transmission technique for producing "fake" effects on "live" broadcasts, constructional details for Band III aerials and a method of testing line output transformers.

The subjects of this issue's article on "Servicing Television Receivers" are the Philips projection receivers, covering models 704, 1700 and 1800. Other articles included are "V.H.F. Mixers" and "High-Q Interference Rejectors." Other features include world television news, letters from readers and answers to readers' TV problems by our panel of experts.

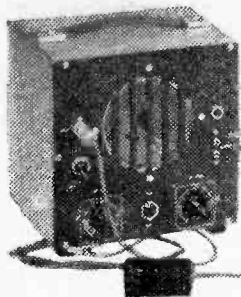

A Set Analyser

AN AID TO SERVICING AND A STAND-BY RECEIVER

By P. D. Cook

No actual wiring diagram is given with this article, but the layout is not critical, and the two accompanying photographic illustrations will show the form of layout which was adopted in the original, and these

THERE may appear to be a great deal in the circuit for this circuit analyser, but the object of using two R.F. stages plus A.F. stages, instead of the normal detector plus A.F. stages, was that it can be used as a receiver when need be, and will trace broadcast signals from the first tuned circuit to the loudspeaker under test. It was found that broadcast signals were not strong enough when living some distance from the transmitter to work the normal signal tracer on a simple circuit, but with the extra two stages there is sufficient gain in hand.

Circuit

The input signal is fed via S1 to either R.F., where it passes through two R.F. stages, detector and finally two A.F. stages, or to A.F., where it passes through only two A.F. stages. The first R.F. valve is a variable μ , and we are thus able to insert an R.F. gain control in its cathode. The second R.F. valve is a high-gain valve, working at full amplification. The signal is fed from this valve to the detector as shown in the circuit. The valve used was a 6AL5, but any R.F. detector may be used. The next two stages are a conventional A.F. amplifier, a further gain control being incorporated.

Construction

As long as leads are kept fairly short, and the power supply is kept to one side of the chassis, no trouble will be encountered.

The size of the chassis used in the original was 7.5in. by 8in., with a front plate of 8.5in. by 8in. By painting the chassis and front plate a very professional appearance will be obtained.

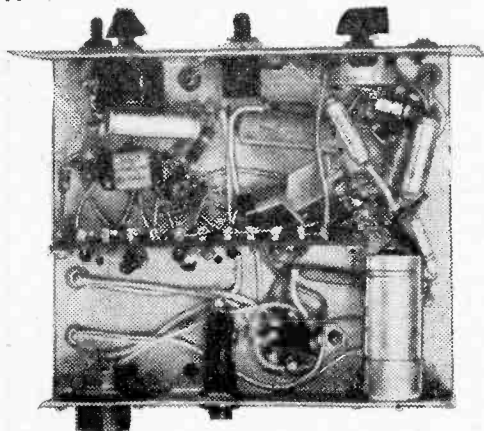

Under-chassis view of the original.

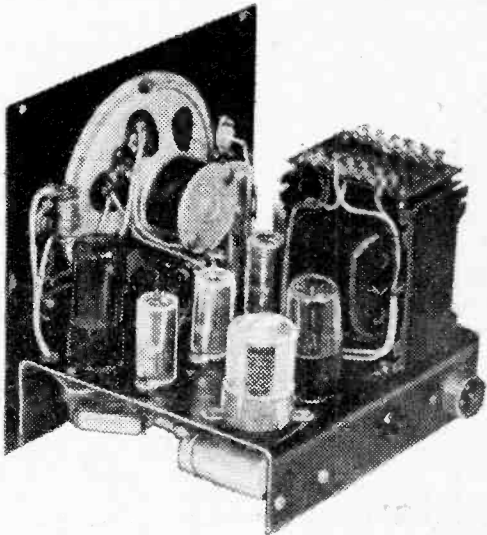

Three-quarter rear view of the prototype. The cabinet is of wood.

can easily be followed if it is desired to duplicate this exactly. The containing cabinet was of wood, polished, and the illustration at the top of the page gives an idea of the appearance which was obtained in the original. It should be emphasised, however, that any desired form of construction may be adopted in this type of unit.

Probe

By inserting a capacitor in the input lead we safeguard the first valve from D.C. voltages, but as this unit is intended to be used for a receiver as well as a test "rig," it was found convenient to insert the condenser in a probe. We can thus withdraw the probe plug and insert any tuned circuit, without the tuning being altered.

Use

The analyser shown has been in use for the past year mainly as a receiver. The tuned circuit is an Osmor coil in parallel with a 0.0005 μ F variable condenser. The only aerial being a few feet of wire.

When in use as a signal tracer the receiver being serviced does not require a signal generator but only needs to be connected to an aerial during broadcasting hours.

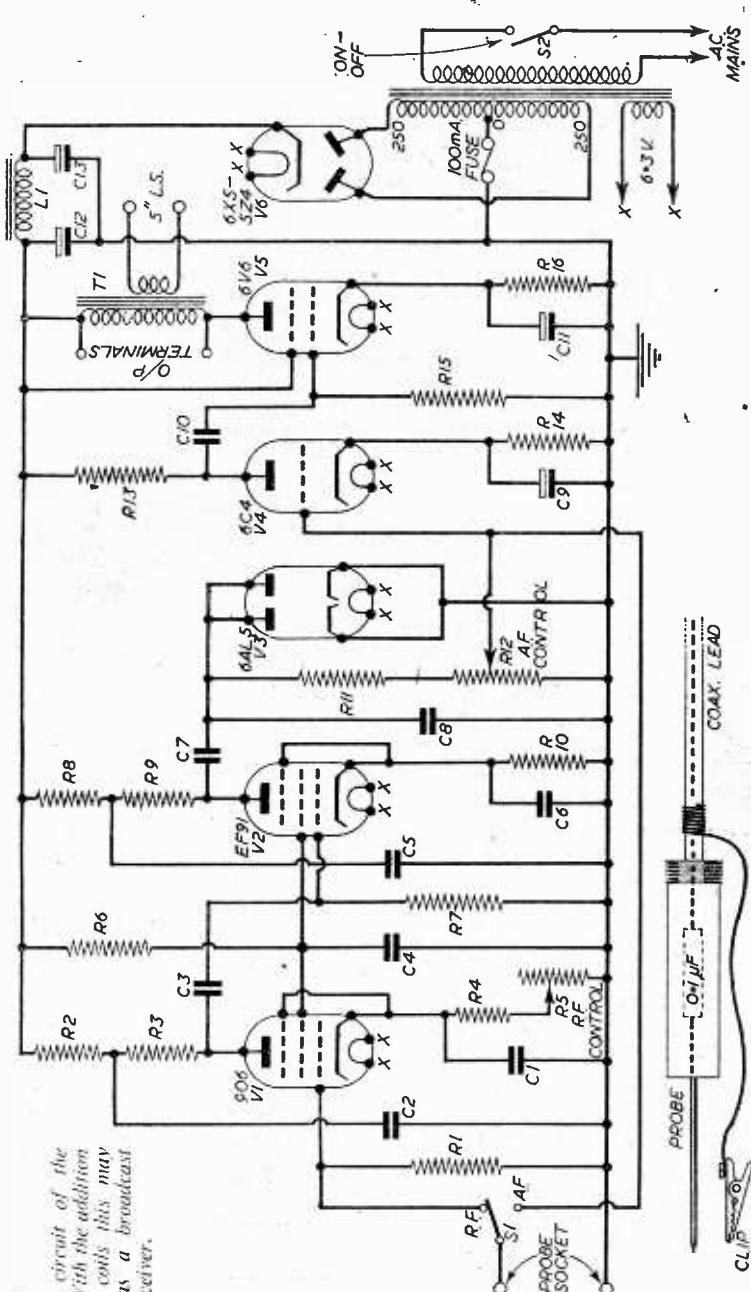

Theoretical circuit of the analyzer. With the addition of suitable coils this may be used as a broadcast receiver.

LIST OF COMPONENTS

- R1—1 Mg Ω.
- R2, R8—4.7 K Ω.
- R3—47 K Ω.
- R4—250 Ω.
- R5—5 K Ω pot. (wire-wound).
- R6—33 K Ω.
- R7—200 K Ω.
- R9—22 K Ω.
- R10—160 Ω.
- R11, R13—200 K Ω.
- R12—1 M Ω. potentiometer.
- R14—800 Ω.
- R15—100 K Ω.
- R16—270 Ω.
- C1, C6—0.01 μF.
- C2, C5, C4, C10—0.1 μF. (350 volt working).
- C3, C7—500 pF mica.
- C8—100 pF.
- C9, C11—25 μF, 25 volt.
- C13, C12—16 x 32 μF, 400 volt.

- V1—9D6.
- V2—EF91.
- V3—6AL5.
- V4—6C4.
- V5—6V6.
- V6—6X5 or 5Z4.
- One Mains Transformer—250-0-250 80 mA, 6.3 volt, 3 amp. (5 volt if 5Z4 is used).
- One smoothing choke 80 mA.

- One O/P transformer with speaker to match (5in.).
- One 1 pole 2-way switch.
- One 2 " " " " " "
- Four B7G valve bases with screens.
- Two international octal bases.
- One fuseholder.
- One coax plug and socket.
- Two sockets for O/P terminals.

ADVERTISER'S ANNOUNCEMENT

FREE! Send 5d. (stamps) for fully descriptive literature including Circuit and Practical Drawings. "The really efficient 5-valve Superhet," 6-valve s'het., 3-valve (plus rectifier) T.R.F. circuit. Battery portable Superhet circuit. Coil and Coilpack leaflets, and full radio and component lists, and interesting miniature circuits, etc.

SPECIAL EDITION
Osмор
News

OSMOR
RADIO PRODUCTS
LIMITED
(Dept. P.64)
415 BRIGHTON ROAD,
SOUTH CROYDON,
SURREY.
CROYDON 5148/9.

PUBLISHED MONTHLY

Vol. 1, No 6.

OCTOBER, 1955

NEW TECHNICAL DEVELOPMENTS IN COIL MANUFACTURE ENSURE PEAK PERFORMANCE!

Osмор are justly proud of the reception given to their products by technical experts and amateurs alike. Osмор's aim, by constant experiment and advanced techniques has always been to provide trouble-free reception and flawless reproduction—coupled with simplicity of construction. Their coils have played a major part in establishing the success of Frequency Modulation and Osмор now offer in addition to many interesting circuits—a free F.M. Tuner Circuit, point-to-point wiring diagram and constructional details, together with full list of components required (just send 5d. in stamps.)

OSMOR 'Q' COIL PACKS

Size only 1 1/2 x 3 1/2 x 2 1/2 with variable iron-rod cores and Polystyrene formers. Built-in trimmers. Tropicalised. Preadigned Receiver-tested and guaranteed. Only 5 connections to make. All types for Mains and Battery Superhets and T.R.F. receivers. Ideal for the reliable construction of new sets, also for conversion of the 21 Receiver. TR1196, Type 18, Wartime Utility and others.



The NEW OSMOR "SWITCH PACK"

Complete and Preadigned full circuit included. State which station required. 2 M.W. 1 L.W. or 3 M.W. **48/-** P. Tax.

ULTRA-SMALL 1/2w INSULATED RESISTORS for V.H.F. etc. 6d. each

10	±10%	390	±20%	15K	±20%	470K	±20%
12	..	470	..	18K	..	560K	..
15	..	560	..	22K	..	680K	..
18	..	680	..	27K	..	820K	..
22	..	820	..	33K	..	1 meg.	..
27	..	1K	..	39K	..	1.2m	..
33	..	1.2K	..	47K	..	1.5m	..
39	..	1.5K	..	56K	..	1.8m	..
47	..	1.8K	..	68K	..	2.2m	..
56	..	2.2K	..	75K	..	2.7m	..
68	..	2.7K	..	82K	..	3.3m	..
82	..	3.3K	..	100K	..	3.9m	..
100	..	3.9K	..	120K	..	4.7m	..
120	±20%	4.7K	..	150K	..	5.6m	..
150	..	5.6K	..	180K	..	6.8m	..
180	..	6.8K	..	220K	..	8.2m	..
220	..	8.2K	..	270K	..	10m	..
270	..	10K	..	330K
330	..	12K	..	390K

ULTRA-SMALL CERAMIC NEG. TEM. CO-EFF. CAPACITORS for V.H.F. etc. 10d. each

1nF	±0.5%	47pF	±20%	560pF	±20%
2pF	..	56pF	..	680pF	..
3pF	..	68pF	..	820pF	..
4pF	..	70pF	..	1,000pF	..
5pF	±20%	82pF	..		±100%
6pF	..	100pF	..	2,000pF	20%
7pF	..	150pF	..	2,500pF	..
10pF	..	200pF	..	3,000pF	..
15pF	..	270pF	..	4,700pF	..
22pF	..	330pF	..	6,800pF	..
33pF	..	390pF	..	10,000pF	..
39pF	..	470pF

OSMOR STATION SEPARATOR

The Separator may easily be tuned to eliminate any one station within the ranges stated and fittings takes only a few seconds. Aerial Sharp tuning is effected by adjusting the brass in here screw provided.



7/6

Type Metres	Type Metres	Type Metres
1-141-350	4-319-405	7-1450-1550
2-216-283	5-335-492	8-410-550 kc/s.
3-267-341	6-455-567	

Special Separator to clear Radio Luxembourg, 10/6 each.

READERS' QUERIES!

Dear Sirs,
I am thinking of making the "Sensitive Two-Valver" ("P.W." Aug.). Please say which coils I should use for best results. For M.W. cup type Q4B1. For LW Q491. Travler Q4A.

Dear Sirs,
The F.M. blessings to some are a nuisance to me because I get considerable interference on my T.V. Can anything be done, please?
This is an easy one which we have already solved. Write to the P.O. or send direct to us for full information.

Dear Sirs,
I am thinking of building an F.M. with the chance of receiving Wrotham at medium strength. When an F.M. Station is working in my area shall I have to make changes?
No changes will be necessary to receive the Station in your area. You should be able to receive Wrotham. Write to us for "V.H.F. explanation" giving areas of reception.

Dear Sirs,
I have recently wound a Ferrite Rod aerial for M. & L. wavebands. Either band works well on its own, but when I connect the two coils the efficiency drops to nothing.
If you use the M.W. coil and switch in a loading coil in series to form the L.W. aerial coil, you will find the efficiency will be maintained. The coils should be loosely fixed to facilitate adjustment. Rod size 8m. x 5/16m.

Calling all amateurs!

Have you a problem involving circuits in which Osмор Coils or Coil Packs are used, or intended to be used? Let our Technical Team solve it—just write us a letter. We're right up to date—we build the various circuits given in "Wireless World," "Practical Wireless," "Radio Constructor," etc., and we stock the components specified. Most Technical Colleges, Universities, etc., use Osмор Coils for research.

"PRACTICAL WIRELESS"

Coronet Four; Beginners' Superhet; An Economical Quality Receiver. A Six Valve A.C. Superhet; Attache Case Portable; RL155 Converter; A.C. Band-Pass 3; Modern 1-Valver; A 2-Valve Feeder; Fury Four, Standard A.C. Power Pack; 3-speed Autogram; modern reflex, etc.

"WIRELESS WORLD"

DESIGN FOR F.M. TUNER, "No Compromise" T.R.F. Tuner, "Midget 3-valve A.C. Mains Receiver," Sensitive 2-valve Receiver, Reflex Push-Pull 3-valve Receiver, Miniature Bedside Receiver, Midget sensitive T.R.F., etc. Trade enquiries invited

"RADIO CONSTRUCTOR"

Converting the TR1196 receiver to a general purpose s'het. receiver simple crystal diode set. Radio feeder units. Economy 8 W.P.P. Amplifier. Whistle Filter Circuit and details available for adding push-pull to the 5/6 valve Osмор superhet, a progressive receiver.



FOR ALL RADIO PARTS . . .

AERIAL RODS
Copper Plated Tubular Rods 12in. long. Will plug into one another to make any length Rod Aerials. 4d. ea.

CHOKES
H.F. Pile Wound Chokes... 1/- ea.
COIL FORMERS
Alladin Coil Formers 2in. complete with Iron Dust Cores 9d. ea.
Alladin Coil Formers 1in. complete with Iron Dust Cores 6d. ea.
Ceramic Coil Formers 2in. dia. (1in. long, 4 Ribs.....) 5d. ea.

PUSH BACK WIRE
7/0076 size. Colours available: White, Blue, Green 21. vul.

MAGNETIC PICK-UP HEAD
For conversion of Acoustic gramophone to Electric reproduction. Fitted with Universal Adaptor for any type of Tone Arm. For use with Standard Size Needles. Highly polished plastic, brown finish. Type 112, 2,000 ohm resistance. Output 0.3 volts. Special Price 17/6 ea.

MICRO SWITCHES
Micro Switch type 5C/1910 Ball type. Interrupted Switch. 3/8 ea.

FLEX MAINS TYPE
Twin 14/0076. P.V.C. covered. 3d. v.d.
CONDENSERS HIGH VOLTAGE
T.C.C. 1 mfd. 250 v. A.C. Condenser with Flying Leads. Metal Case. 1/3 ea.

LINE CORD
3 Amp. 3 Core 60 ohms per foot. 1/6 yd.
2 Amp. 3 Core 60 ohms per foot. 1/6 yd.

ION TRAPS
Type 176 for Tubes with 35 mm. neck diameter. 2/0 ea.

AMPLIFIER OR CHARGER CASE
Brown crackle cabinet with removable chassis, and bakelite front panel. Size 9 1/2in. width x 7 1/2in. height x 6 1/2in. deep. 8/6 ea.

NUTS & BOLTS
Box of nuts, bolts and washers. 4BA countersunk and round head. Over 100 items. 1/- box.

EXTENSION SPEAKERS
Defiant extension loudspeaker in attractive pale green cabinet. Volume control fitted. 6 1/2in. speaker unit. 4/2 ea.

YAXLEY SWITCH 1 pole 3-way 1/6 ea.

HEAVY DUTY OUTPUT TRANSFORMER
Suitable for PX4 or 6L6 valves in push pull. 12/- ea.

MICROPHONE STAND
Folding microphone floor stand, adjustable. 2/- ea.

HEADPHONES
CLR Low resistance type 120 ohms. 7/6 pr.
CHR High resistance type 4,000 ohms. 13/6 pr.

WESTINGHOUSE 1 mA. Rectifier wire ends. 9d. ea.

PERSPEX IMPLISSION GUARD
Incorporating brown esutchouan and grey filter, drilled ready to fit to cabinet. 12in. type 11/- 16in. type, 12/6.

EX-MINISTRY BAKELITE DOUBLE-POLE TOGGLE SWITCH Single hole fixing. 1/8 ea.

9 volt VIBRATOR PACK complete with 4 pin Vibrator. 15/- ea.

GOOD QUALITY, Maroon cotton covered .2 amp. 3 core line cord. 1/8 per yd.

MORPHY RICHARDS type Replacement Iron Elements. 8/8 ea.

PLIERS and Side Cutters, 3/- pr.

CHOKES
Wavox choke, max. current 100 mA. D.C. resistance 125 ohms. 6/- ea.

SILVER MICA CONDENSERS
Dozens of sizes available, including 30 pF, 50 pF, 15 pF, 100 pF, 200 pF, 300 pF, 500 pF, 1,000 pF, etc., etc. Price 3 1/2d. ea.

MOULDED MICA CONDENSERS
All by well-known makers. T.C.C., Dufilier, Hunts etc. .0001 (100 pF), .0002 (200 pF), .0003 (300 pF), .0005 (500 pF), .001 (1,000 pF), .01 (10,000 pF), etc. All 4 1/2d. each.

PRESET CONTROLS (Carbon). Fully insulated. 50K ohms, 1 meg. 1 meg. 2 meg. 3/6 ea.

MAINS TRANSFORMER
Input 300/250 v. output 325-0-325 v. 20 mA. 6.3 v. 3 a. 11/- ea.

DRYDIEK TORCHES AT BIG REDUCTIONS

2PT5 Penlight, chrome, clips into pocket like a pen.....17 ea.

2N3 Handrite (coloured) suitable for ladies' handbags17 ea.

N15 Candlelike (coloured) ideal for child's bedroom.....3/6 ea.

Prices include bulb but exclude batteries.

COLLARO High Fidelity Pick-up for standard records. Listed 46/5. Our Price 35/- ea.

METAL TUBULAR CONDENSERS (WIRE ENDS)

Sprague 1 mfd. 350v. ...	9d. ea.
" .01 .. 1,000v. ...	8d. ea.
" .02 .. 750v. ...	9d. ea.
" .05 .. 500v. ...	9d. ea.
" .001 .. 1,000v. ...	4 1/2d. ea.
T.C.C. .01 .. 750v. ...	8 1/2d. ea.
Mallory 1 .. 500v. ...	1/- ea.
T.C.C. Metalplate .02 mfd. 350 v.	8d. ea.
Sprague, 5 mfd. 350 v. ...	6d. ea.

Mail Order only. For terms see our advertisement on Page No 579. WHEN ORDERING PLEASE QUOTE "DEPT. P.W."



5/6 VINCES CHAMBERS VICTORIA SQUARE LEEDS I.

FREE! to YOU! - if you seek SUCCESS!

Train your mind to SUCCESS

WHAT'S YOUR LINE ?

Building	Accountancy Exams.
Carpentry	Auctioneer's Exams.
Commercial Art	Book-keeping
Diesel Engines	Civil Service
Draughtsmanship	Costing
Electrical Eng.	English
Locomotive Eng.	General Education
Mechanical Eng.	Journalism
Motor Engineering	Languages
Quantity Surveying	Mathematics
Radio Engineering	Police Subjects
Surveying	Salesmanship
Telecommunications	Secretarial Exams.
Television	Shorthand
Textiles	Short Story Writing
Wireless Telegraphy	and many others

GENERAL CERT. OF EDUCATION

If you lack the qualifications which would get you a better job; more pay and quicker progress; if you wish to know how The Bennett College can guarantee to teach you up to qualification stage by one of the easiest, quickest and soundest methods of mind training; if you wish to learn how Personal Postal Tuition can prove that you are cleverer than perhaps you think you are — if you like the idea of studying in your own time, at your own pace, with your own tutor guiding you, helping you, teaching you by post— send at once for this recently published important book—"Train your mind to SUCCESS". It is quite free. Just fill in the coupon below and name the subject you are interested in (some of the many Courses available are listed here). Then send in the coupon to us TODAY. You will never, never regret it. But do it today. Act NOW!

BENNETT COLLEGE (DEPT. J104F), SHEFFIELD

Please send me, without obligation, a free copy of "Train your mind to SUCCESS" and the College Prospectus etc.

SUBJECT _____

NAME _____

ADDRESS _____

_____ AGE (if under 21) _____

Please write in Block Letters

THIS DAY COULD BE THE TURNING-POINT IN YOUR LIFE.

THIS COUPON COULD BE YOUR PERSONAL PASSPORT TO SUCCESS. Send it NOW!

TV CHASSIS 97/6

T.V. 12in. CHASSIS. 97/6. Complete chassis by famous mfr. R.F. E.H.T. unit included. Drawing 2/6 or free with order. Easily fitted to table or console model owing to this chassis being in three separate units (Power, Sound and Vision. Time base) interconnected. This chassis is less valves, speaker and tube, but see our catalogue for cheap valves. Our £5 Tube fits this chassis. Carr. 5/- London, 10/- Provinces.

T.V. TIME BASES. 10/6. Containing scanning coil, focus unit, line trans., 10 controls, etc.; famous mfr. Drawing FREE. Post 2/6.

POWER PACK. 29/6. 5KV. EHT. 325V. 250 mA. smoothed H.T. heaters 6V. 5 amp., 4 v. 5 amp., 4 v. 5 amp., with extra winding for 2- or 4-volt tubes. Carr. 4/6.

T.V. SOUND AND VISION. 27/6. 5'net, complete sound and vision strip, 10-valve holders. Post 1/6.

V.H.F. 1125 RECEIVER. 7/9. Complete with valves. New X.W.D. Post 2/3.

V.H.F. 24 RECEIVER. 10/6. New X.W.D. Complete with valves. Post 2/3.

DENCO RADIOGRAM CHASSIS. £5/17/6. 5'net. Famous turret coil pack. Modern international octal valves included. Front controls. 5 valve 4 w/band. 8in. P.M. speaker with O.P. trans. to match 12/6 extra. Post 4/6.

TELE: GRA 6677

MONEY BACK GUARANTEE

DUKE OR COD

621 ROMFORD RD. LONDON. E.12.

IMPROVING AMPLIFIER PERFORMANCE

MODIFICATIONS WHICH MAY BE MADE TO ALMOST ANY AMPLIFIER TO GIVE IMPROVED RESULTS

By W. J. Delaney

(Continued from page 542 September issue)

WE now come to the most important parts of the amplifier, namely the input and driver stages. It is here that the most interesting improvements may be applied. Fig. 7 shows the two most commonly employed driver stages, the first (a) using a single triode with outputs taken from anode and cathode, and the other (b) using two valves for two halves of a double-triode, with the necessary second signal at opposite phase obtained by what is commonly known as the "tapped grid" connection. Both of these produce two signals at exactly opposite phase, but in other respects the two signals are very dissimilar. In the first case the effective output resistance is different for the two outputs, the anode operating with current feedback and the cathode with voltage feedback. The anode signal is, therefore, much stronger than the cathode signal, and it is difficult to balance the two volumes. The output capacity is also different and consequently the high-note response in the two halves is not identical. In the second circuit the signal emerges from the upper valve and is passed direct to one of the output valves (or the following stage). Part of the signal is tapped off the grid leak and fed to the lower valve, the output of which forms the other half of the signal for the subsequent stage. Thus this part of the signal has passed through two valves which will affect the quality, as well as the actual strength. There are various effects on the two signals in these forms of driver, but sufficient has been said to show that although two out-of-phase signals are obtained they are considerably different in their actual form. The principal difference is that the signal is unbalanced at high and low frequencies. Whilst it is possible by taking elaborate precautions to reduce this unbalance to very low proportions it is almost impossible to eradicate it completely, and in any case the ordinary amplifier is not designed to do this.

Cross-coupled Amplifier

These difficulties are overcome by what is known as the cross-coupled amplifier, and although in its complete form it calls for four valves (or two double-triodes) it undoubtedly gives very much better quality than other schemes and is well worth the trouble of setting up. This is rather tedious, and is one of the drawbacks, the other being that it requires

checking every month or so if maximum performance is to be obtained. On top of this, the testing should really be carried out with a valve voltmeter, and although a very good, high-resistance meter can be used, it does not permit of optimum results.

The basis of the cross-coupled stage is shown in Fig. 8, in which it will be seen that the input is taken to the grids of two valves (instead of the customary grid and cathode of a single valve). In addition the two grids are connected to the cathodes of their opposite number thus giving an input between grid of one valve and cathode of another. If an earth is tacked on to the lower valve in this illustration, that valve will be acting as a grounded grid amplifier with cathode input, thus calling for a low impedance input. The signal thus becomes applied to two valves in opposite phase and a push-pull output is available from the two anodes. Unfortunately, there are a number of complications in the skeleton circuit as shown, principally concerning the application of bias and H.T. and certain modifications have to be made to convert this into a practical arrangement. The latter is shown in Fig. 9, and from this it will be seen that if a push-

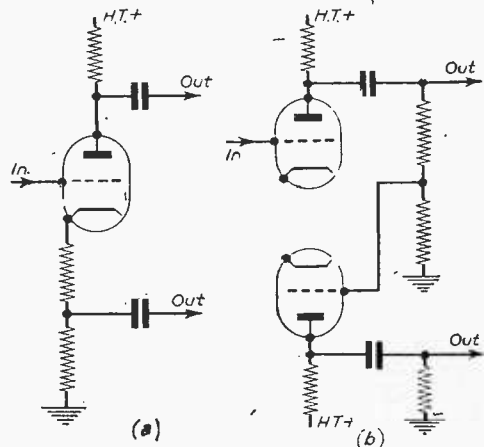

Fig. 7.—The two commonest forms of push-pull driver stage.

pull stage is added there will only be the two coupling condensers shown on the right in the entire circuit, thus reducing phase shift and reproduction difficulties. The second (double) valve in this circuit acts as the valve in Fig. 8 (treating these as double-triodes), and the first stage in Fig. 9 is added to facilitate D.C. connections. In this circuit, the variable resistor providing bias for the two sections of first stage also

this in an amplifier of the type of the Williamson (which has been taken in this short series as a standard) a normal driver stage is added with the omission of the condensers shown in Fig. 9. This calls for a biasing arrangement as shown in Fig. 5 of the series, and the push-pull stage in Ultra-linear operation follows. Thus the final change in such an amplifier consists of the addition of a 9-pin valveholder with a double-triode valve of the ECC82 (12AU7) type, and the changes in circuit which have been mentioned. With suitable values it will be found that greatly improved transient response, as well as a considerable extension in the frequency range, are obtained and, as good as the Williamson is, in its present form, this change will be found quite noticeable, with the proviso mentioned in the opening article, that a good loudspeaker assembly must be employed or the changes will be inaudible.

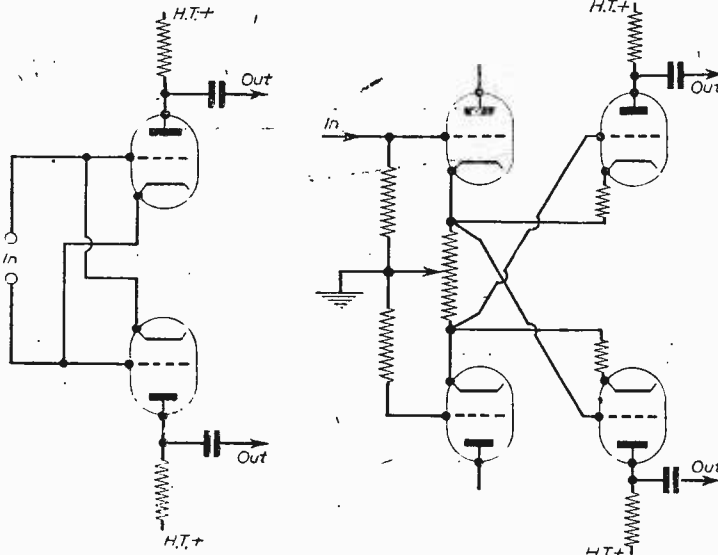

Fig. 8. (left)—A balanced phase-splitter, and Fig. 9. (right)—a full cross-coupled driver stage.

provides a balancing control, the arm being set when the circuit is put into use so that no output results when a pick-up or generator input is applied to the first two grids. As a result this is known as a "Balancing Control." The full manner in which this operates is rather difficult to explain, the signal appearing in the cathode circuit of the upper valve of the first stage and thus automatically in the cathode of the lower valve, and this provides a balanced output applied to the second pair of valves, which brings us back to the arrangement shown in Fig. 8. The first two valves thus become the low-impedance generator which is indicated in Fig. 8, and we are enabled to use any type of input in the Fig. 9 arrangement.

Direct-coupled Amplifier

The first two triodes in the first stage in Fig. 9 are connected direct to the H.T. line, so that this stage is a cathode-output arrangement, and to use

ageing valves. This modification is the neutralisation of the two stages shown in Fig. 9. A very small capacity is connected from the anode of the upper triode in the diagram to the grid of the lower one, and from the anode of the lower one to the grid of the upper. These cross-connected neutralising capacitors, which may be a lin. length of twisted flex, balance out stray capacities, but the average amateur will not have suitable apparatus for adjusting these, and therefore must take a chance on the capacity suggested. Alternatively, a ceramic condenser with a value of 1.5 pF may be used in its place and will be about right for the type of valves mentioned.

Finally, remember that this type of direct-coupled amplifier requires at least a monthly test, or meters should be mounted on the chassis or panel with push-button control, so that the balance and biasing arrangements may be kept correctly adjusted.

Radio-astronomy at Cambridge

THE University of Cambridge has recently received from the Mullard Company an offer to provide over a period of 10 years the sum of £100,000 for the purpose of continuing and extending the work in radio-astronomy which is in progress in the Cavendish Laboratory. With this benefaction it is intended to set up a new observatory to be known as the Mullard Radio-Astronomy Observatory. It is hoped that a site near Cambridge will be available

for this purpose and that there will be space on it for making a number of observations which have not yet been possible.

The investigations which will be made at the Mullard Observatory will be largely complementary to those for which a different type of equipment, the large paraboloid radio telescope at Manchester University, is best fitted. The combination of the two different types of instrument will be important in maintaining the lead of this country in this new field of astronomical research.

A Versatile BENCH POWER SUPPLY

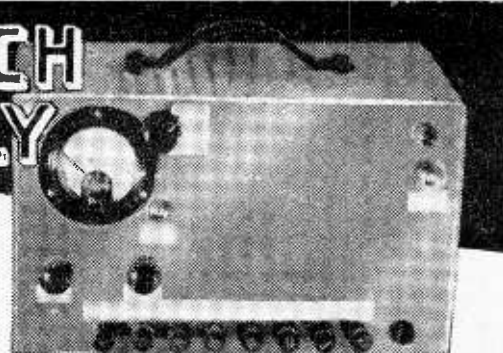

A STABILISED POWER UNIT FOR THE EXPERIMENTER OR SERVICEMAN

By A. Shaw

THE amateur radio enthusiast so often needs a bench power supply that reasons for designing and building such a unit need not be given. To be of maximum value it must be capable of providing all the commonly used H.T.+, heater and filament voltages, including those required by battery powered equipment. The H.T.+ output must, therefore, be variable between approximately 65 volts and 250 volts and sufficiently well regulated and ripple free to apply, in particular, to battery-powered equipment and, to a lesser extent, to mains-powered equipments which demand a high degree of load stability and regulation from their power supplies.

These requirements are readily fulfilled by a voltage-regulated supply; in addition, such a supply offers the further advantages of the H.T.+ output being independent of the load current up to a maximum specified value of load current and being substantially independent of fluctuations in the mains voltage supply. The independence of the H.T.+ output to the load current results in a very low value of output impedance, thereby considerably reducing the possibility of motor-boating in audio amplifiers. The power unit shown at Fig. 2 offers the following performance:

- (a) H.T.+ output variable between 65 volts and 250 volts.
- (b) H.T.+ output load stabilised to 75 milliamps at 230 volts.
- (c) No variation in H.T.+ output for a 16 per cent. variation in mains input.
- (d) 4 millivolts ripple at 230 volts with 75 milliamps load; 4 millivolts ripple at 75 volts with 75 milliamps load; 2 millivolts ripple off load.
- (e) A.C. heater outputs of 12 volts, 6.3 volts, and 4 volts.
- (f) D.C. filaments variable between 7.5 volts and 0 volts.

General

Before discussing the unit shown at Fig. 2 it would perhaps be as well to consider the general principles involved. The commonly used arrangement is that shown at Fig. 1. It will be seen that T1, V1, L1, C1 and C2 comprise a normal rectifying and filtering circuit which delivers an imperfectly regulated D.C. voltage to the

anode of V2, the series regulator. The grid voltage of V2 is primarily determined by the control grid/cathode voltage existing at V3, a sharp cut-off pentode whose cathode is held at a constant reference voltage by the neon N1. Variations in the output will appear at the control grid of V3 in a proportion decided by the values of R4, RV5, and R6, where, by altering the grid/cathode voltage they will cause V3 to pass either more or less current, as the case may be. This, in turn, will modify the anode voltage of V3 and, since V3 is directly coupled to V2 grid, will alter V2 grid voltage in such sense as to restore the output to the value from which it originally varied. Say, for instance, that the output fell. A proportionate fall would appear at the grid of V3, decreasing V3 anode current, increasing V3 anode voltage and thereby V2 grid voltage. Since V2 has no control, within limits, over the load current, a decrease in bias results in a lower series resistance, and the output will rise. In practice the component values are chosen such that the gain of the loop immediately counters a fall in output by an equal rise, so that, to all intents and purposes, the output remains constant. This regulating action applies to variations due to mains input fluctuations, variations due to changing load currents and variations due to ripple.

H.T.+ Supplies (Fig. 2)

T1, V1, L1, C1 and C2 comprise a filtering and rectifying circuit which delivers approximately 380 volts of imperfect D.C. to the regulator section and specifically to the anode of the series regulator,

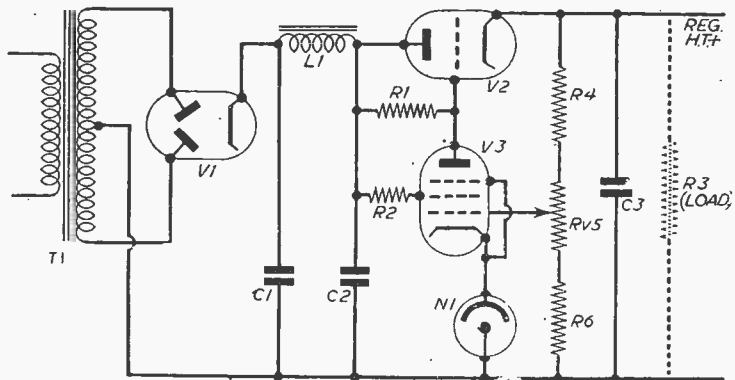
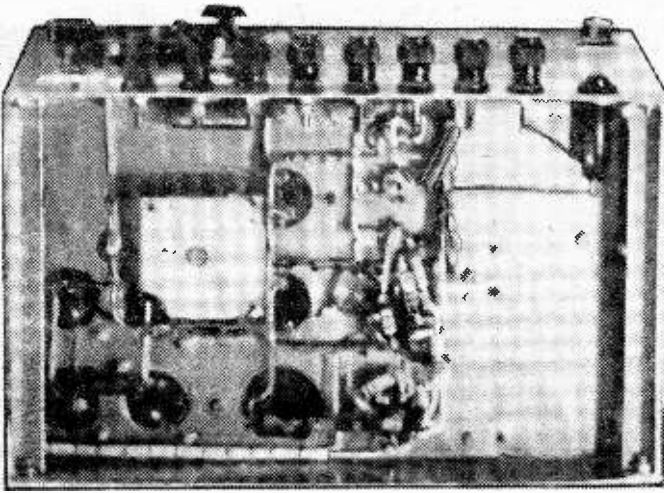

Fig. 1.—The normal arrangement of a stabilised power supply.

a triode connected KT66, through parasitic stoppers, R1 and R2. The control grid voltage of the KT66 is derived from V3, a Z77, essentially as shown in the basic arrangement of Fig. 1. In order that the H.T. +

the series dropper, R11, to the neon, N1. It should be noted carefully that if C4 and C5 are capacitors whose cans are not isolated they must be completely insulated from the chassis. In the writer's unit this was done by mounting these two components on a paxolin base. They must also, of course, have their positive tags earthed. The voltage at the cathode of N1 is thus of the order of -60 volts, which is relatively well regulated and the value of R9 ensures that V3 is adequately biased, while RV8 provides the desired range of H.T. + outputs.



Under-chassis view of the instrument described.

may be set as low as 65 volts, the reference voltage at the cathode of V3 must be lower than is usual in power supplies of this kind. Unfortunately, there is no readily available neon which will maintain ionisation at less than about 60 volts, which is too high, and, therefore, the system has been referenced to earth. This, in turn, requires that the sampling chain, R6, RV8 and R9, is returned to a negative voltage in order that V3 may be adequately biased. This may appear to effect the saving of a neon, but unfortunately this is not so, for it is completely essential that the negative voltage itself be regulated. If this was not the case the regulation of the output (as opposed to the stabilisation) would be no better than that of a normal power supply using only an L.C. filter, in other words, little better than that of the mains. The negative voltage is derived by negatively rectifying one side of the H.T. output from T1; the additional current thereby drawn from one side of the 350/0/350 volt winding is only some 6 milliamps, which will not unbalance the transformer to any significant extent. About -350 volts thus exists at the strapped anodes of V4, a 6X4, which after smoothing by R10, C4 and C5, is applied through

Unfortunately, C4, C5 and R10 do not deal efficiently with 50 c/s ripple, which has a marked effect on the output ripple content. For this reason C3 and R7 have been included to feed the output ripple back on to the control grid of V3, which reduces ripple in the output to the tolerable level of 4 millivolts on load. C6 ensures complete load decoupling.

A.C. Heater Supplies

The A.C. voltages brought out for bench heater use are largely determined by what heater windings

COMPONENT LIST (FIG. 2)

- | | |
|----------------|------------------|
| R1—1 k. | R11—68 k. 2 w. |
| R2—47 | R12—6.8 5 w. |
| R3—470 k. | R13—250 5 w. |
| R4—18 k. 2 w. | R14—10 5 w. |
| R5—1 k. | R15—3.3 k. |
| R6—150 k. 2 w. | C1—8 μF 500 VDCW |
| R7—1 m. | C2—4 μF 500 VDCW |
| R8—100 k. w.w. | C3—1 μF 500 VDCW |
| R9—47 k. 2 w. | C4—4 μF 500 VDCW |
| R10—33 k. | C5—8 μF 500 VDCW |

All resistors 1/2 watt unless otherwise noted.

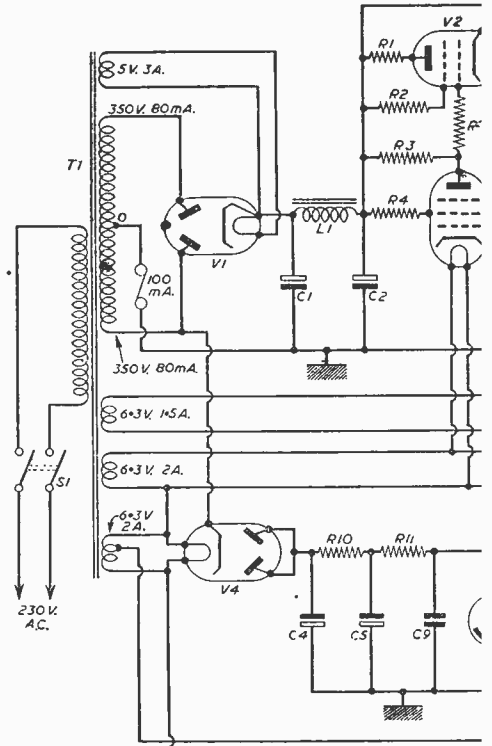
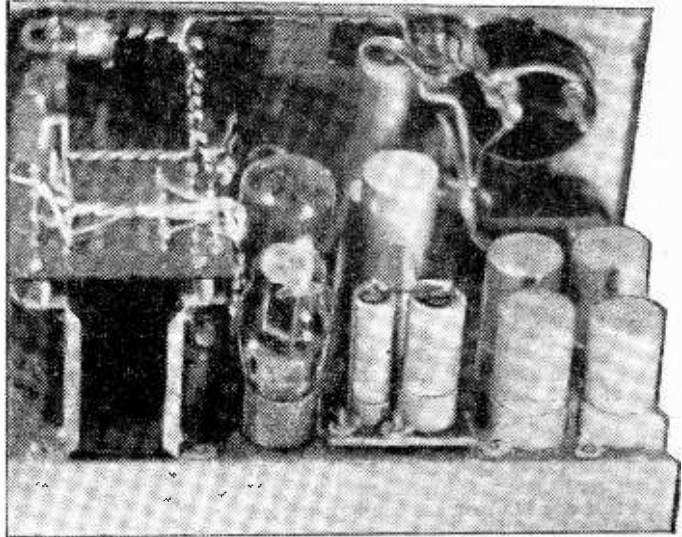

Fig. 2.—Theoretical circuit

are available at T1. In the writer's case T1 had three separate 6.3-volt windings, two of which were tapped at 4 volt. It was, therefore, possible to obtain 12 volt, 6.3 volt and 4 volt outputs. The only 5-volt winding had to be used for V1 and was, therefore, at a high D.C. potential. In consequence, it was definitely not available for bench use. This leads to a point which it is well to keep in mind. The cathode of the KT66 is also at a high D.C. potential and its heater supply must, therefore, be referenced to its cathode. Hence, under no circumstances whatever can any other use be made of the heater supply for the KT66. On the other hand the cathode of the Z77 is at earth; heaters supplies for this valve, therefore, may also be used to supply the 6X4 and/or for bench use. By much the same token it is not advisable to reference bench supplies to earth; this can on occasions be most inconvenient and, in any case, can always be done at the front panel if desired. Finally, and with due deference, do make sure that if you intend to connect two

6.3-volt windings in series to obtain 12 volts you do connect them in series. This can also be inconvenient — and expensive.



Above-chassis view of the unit.

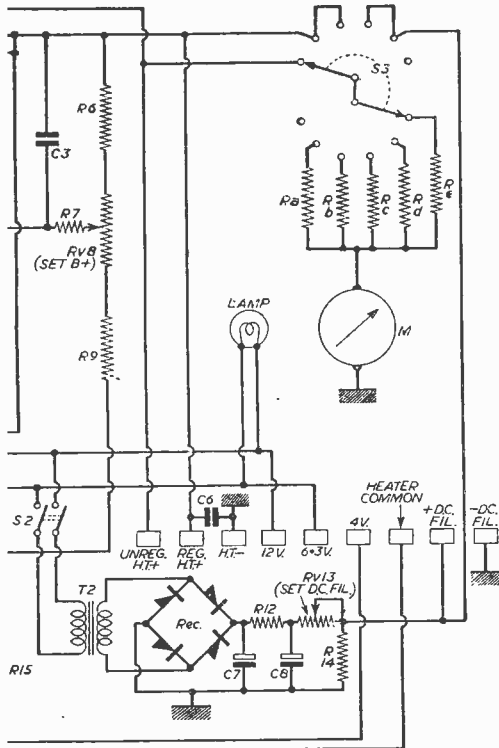

the bench power supply unit.

D.C. Filament Supplies

The highest filament voltage likely to be required is 7.5 volts at 50 milliamps. The lowest is generally 1.4 volts at 250 milliamps. These voltage and current requirements are modest enough, but in between the two limits lies the old enemy, five 2-volt valves each consuming 0.2 amps. The worst current drain likely to be encountered is thus 1 amp., and the supply circuit components must be rated accordingly. The F.W. bridge-type rectifier, Rec, requires an A.C. input in the order of 12 volts. This may be obtained from a commercial type of heater transformer; or from the 12-volt bench output; or, as in the writer's case, from a rewound output transformer, which at least has the merit of being cheap. In the event that poor and needy individuals wish to rewind an old output transformer the following data are given for reference:

(a) The minimum cross-sectional area of the centre limb of the laminations used must not be less than 0.25 sq. in. It is very advisable to use the largest it is possible to obtain.

COMPONENT LIST, Continued

- C6—1 μ F 350 VDCW
- C7—1,000 μ F (2..500) 25 VDCW
- C8—3,000 μ F (2 x 1,500) 15 VDCW
- C9—.1 μ F 350 VDCW
- S1—DPST (Bulgin)
- S2—DPST (Bulgin)
- S3—2-pole, 6-way rotary
- L1—10 H. at 150 mA
- T1—350/0/350 at 80 mA (see text)
- T2—See text
- Rec—FW Bridge 15 v. at 1 A.
- V1—To suit T1
- V2—KT66 or 6L6
- V3—Z77, 6J7, 6S, J7, etc.
- V4—6X4 (see text)
- N1—See text
- One 6-v. bulb and holder
- Nine panel mtg. insulated terminals
- Meter (see text)

(b) The turns per volt that must be wound on for both primary and secondary windings is given by :

$$T_{pv} = \frac{10^8}{13.32A}$$

where A is the cross-sectional area of the centre limb of laminations.

(c) Since the maximum secondary wattage (2) is known, the corresponding primary current can be calculated from Ohm's Law. Reference to wire tables will give the correct gauges of wire with which the secondary and primary windings must be wound. In all respects the D.C. filament section is entirely conventional. The writer used a 6.8Ω resistor in place of a smoothing choke, only because no choke was available, or wire to wind one, but it cannot be denied that the choke is a superior arrangement. A suitable choke can be constructed by winding about 300 turns 18 or 20 s.w.g. wire on some suitably sized laminations, or at worst merely round and round a cardboard tube without laminations. The important point is, however, that it must have as low a resistance as possible, certainly less than 6.8Ω , and preferably of the order of 2 or 3Ω .

Metering

M1 was included to avoid the necessity of having external meters hanging all over the place; it is so connected that any D.C. output can be observed by suitable switching of S3. Five voltage ranges are provided by the switching of the five series resistors. These are: 0/1.5 volts; 0/15 volts; 0/150 volts; 0/300 volts; and 0/500 volts. The values of the series resistors depend entirely upon the basic movement of M1 and they have not, therefore, been given; they also depend, of course, upon the voltage ranges that each individual constructor desires. In general:

$$R, \text{ the series resistor} = \frac{V}{I} - R_m$$

where: V = the full scale voltage desired;

I = the current giving F.S.D.;

R_m = the internal meter resistance.

S3 is connected in such a way that only low voltages can be applied to the low voltage ranges and only high voltages to the high voltage ranges.

Components and Layout

A full component list is given on pages 612 & 613. In a unit of this type many substitutions are possible, but should not be too liberal.

In particular the current ratings of T1, L1, V1 and V2 should be adhered to closely. The load stabilisation will only be as good as the H.T. current rating of T1 and adequate stabilisation and regulation will be achieved only if the H.T. from T1 is sufficiently high to maintain a reasonable P.D. across V2 with Rv8 set to the highest H.T. + output it is possible to obtain. V2 must be a valve that is capable of passing comfortably the highest current it is proposed to draw from the unit and either a KT66 or a 6L6 will pass 80 milliamps. On the other hand, if individual requirements are more modest, there is no reason why T1 and V2 should not be less highly rated components. V1 may be any adequately rated rectifier, while V4, which has to pass at worst only 10 milliamps, may be either thermionic or metal. V3 can be any sharp cut-off pentode, a Z77 happens

to be conveniently small and the neon, N1, must be such that it maintains a P.D. across itself in the order of 60-65 volts. M1 and the associated series resistors will depend on individual holdings and requirements.

Fundamentals of Iron-selenium Cells

By E. G. Bulley

THIS type of cell is really a development from the selenium rectifier, and falls into the semiconductor category. It consists of an iron plate which is either circular, rectangular or square. The iron plate can be considered as the basis of the cell, on to which a layer of pure selenium is applied. This layer is processed by heat treatment and annealed, as a result of which it produces a

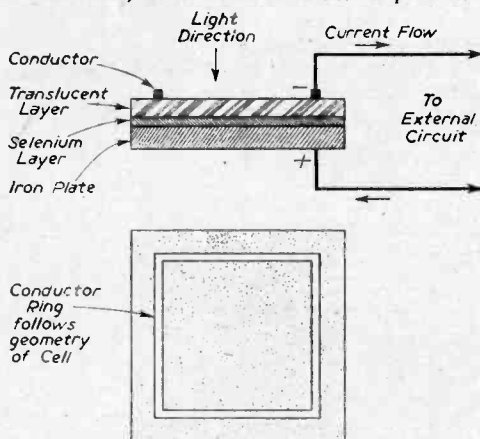

light-sensitive surface. The sensitive area is then sputtered with a translucent metal coating and the whole area is sometimes encased within a silver frame. This usually follows the geometry of the iron plate as shown above.

The translucent coating forms one electrode, the purpose of which is to collect the negative electrons that are emitted from the sensitive surface, namely, the selenium coating. This phenomenon is the result of the action of light being directed on to the sensitive area via the translucent coating, thus causing electrons to be emitted and collected by the negative electrode, which in turn are transferred either direct or from the conducting ring to external circuitry and back to the iron base plate, thus completing the circuit.

One will, therefore, appreciate that unless such cells are exposed to light, no current output from the cell is possible.

These cells have many uses, the main ones being in exposure meters and light meters, the former being used mainly for photography purposes.

Iron-selenium cells are more or less linear when exposed to medium light intensities, but when exposed to light of very high intensity they have a tendency to be less linear. Furthermore, at the higher intensity, leakage occurs between the two electrodes, the reason being that large currents result in the internal resistance of the cell being reduced.

STERN'S AMAZING BARGAIN OFFER!!

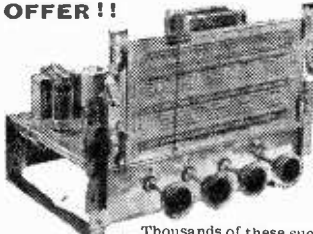

Modernise your old Radiogram

WE HAVE BOUGHT THE ENTIRE STOCK OF THE FAMOUS MODEL B3 PP RADIO OR RADIOGRAM CHASSIS. A 6-VALVE 3-WAVE-BAND SUPERHET WITH PUSH-PULL OUTPUT.

Thousands of these successful and very popular Receiver Chassis have been sold for £15.15.0 each. WE CAN NOW OFFER THEM FOR **£11/19/6** (plus 7/6 carriage and insurance).

H.P. Terms: Deposit £4.0.0 and 9 Monthly Payments of 19/11. These Receiver Chassis have proved to be about the most popular and successful yet offered. Designed to most modern specification, with great attention given to quality of reproduction, giving excellent clarity of speech and music on both Radio and Gram.

They are the ideal replacement chassis for that "Old Radiogram." etc. ALL CHASSIS ARE BRAND NEW AND GUARANTEED FOR 12 MONTHS (B.V.A. VALVES 30 DAYS).

A BULK PURCHASE ENABLES US TO OFFER THIS "PUSH-PULL" 7-VALVE

SUPERHET RECEIVER

for only £12.19.6. (Plus 7/6 carr. and ins.) H.P. Terms £4.0.6 Dep. 10 Months at 19/4. Model AW3-7 Receivers are made by a well-known manufacturer and incorporate the latest Osram Valve line-up, having two N78's in Push-Pull for approx. 7 watts output.

They cover 3 wavebands and are for operation on A.C. mains. They make an excellent replacement radiogram chassis. THEY ARE BRAND NEW AND FULLY GUARANTEED.

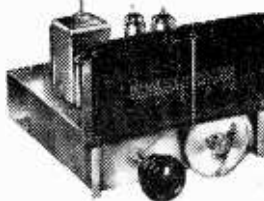

THE DENCO F.M. FEEDER UNIT INCORPORATING AN R.F. STAGE

A 5 VALVE SUPERHET DESIGN having a frequency coverage of 88 to 100 mc/s. This F.M. Receiver is designed to operate with any type of Amplifier and most Radio Receivers. It incorporates R.F.—F.Changer and two I.F. Stages followed by a Ratio Discriminator, the valve line-up being 6AM5—12AH8—two 6BA6s and 6AC5. Overall size of assembled Chassis 7in. x 5 1/2in. x 4 1/2in. high excluding power supply, or 7in. x 8in. x 4 1/2in. high with power supply.

The CONSTRUCTOR'S MANUAL, containing Circuit Diagram and Component Lay-out, etc., is available for 1/6, and WE CAN SUPPLY ALL SPECIFIED COMPONENTS including Valves and Drilled Chassis for **£6/13/6** (plus 7/6 carriage and ins.)

- or for £7.2.6 with Dial Assembly as illustrated. WE WILL ALSO SUPPLY IT ...
- (a) Assembled and Ready for use, excluding Dial Assembly £9/17/6.
- (b) Assembled and Ready for use, including Dial Assembly (as illustrated), £9/10.0.
- (c) Assembled and ready for use, with Dial Assembly and "Magic Eye" Indicator mounted in centre of Dial, £10/10.0.
- (d) We can also supply (a), (b) and (c) with and including an H.T./L.T. Power Supply for an additional £2/17.6. The Supply Unit is also available as a separate Unit, size 6 1/2in. x 3 1/2in. x 5in. high. Provides 250 volts at 50 mA., and 6.3 volts at 2 amps.

TWO COMPLETE Hi-Fi AMPLIFIER KITS

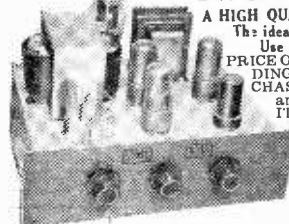

A HIGH QUALITY 8-10 watt AMPLIFIER

The ideal Amplifier for General Home Use and for Small Halls etc

PRICE OF COMPLETE KIT INCLUDING VALVES AND DRILLED CHASSIS £7/10.0. (Plus 2/6 carr. and ins.) WE WILL SUPPLY IT COMPLETELY BUILT FOR £9/10.0 (plus 5/- carr. and ins.). H.P. terms £3.3.6 dep. 9 months at 18/-. Designed for high quality reproduction up to an output level of 10 watts, having 6V6s in Push-Pull and incorporating

negative feed-back. Suitable for use with all types of Pick-ups and most types of microphones and the output transformer provides for use of 3 and 15 ohm speakers. BRIEF FEATURES:

- Valve line-up 6J5, 6SN7, 5Z4, with 6V6s in push-pull. • First-class reproduction of radio (where a tuning eye is used) and record playing. • Separate Bass Boost and Treble controls provide an excellent range of frequency control. THE ASSEMBLY MANUAL is available for 1/- and includes detailed layouts and component Price List.

A 12-Watt "HIGH FIDELITY" Push-Pull AMPLIFIER

Comprising a Main Amplifier Chassis and a Remote Control Pre-Amplifier/Tone Control Unit. The remote control unit measures only 7in. x 4in. x 2in. and contains four controls, being: Bass-Treble-Volume and a Radio, Gram, Microphone Switch control. It incorporates its own feed-back circuit on the Bass Channel. Loop negative feed-back is employed on the Main Amplifier which has a valve line-up of 6J5-6SN7-5U4 with two 6X25s in push-pull and 6J5 and 6SN7 are used in the remote control unit. THE COMPLETE UNIT ASSEMBLED AND READY FOR USE £17/0.0. (Carr. and ins. 5/- extra.) H.P. Terms £4.5.0 Dep. 12 Months at £1.35. This Amplifier compares well with the Williamson and similar designs at a fraction of their cost. The complete set of assembly instructions is available for 2/-.



THE COMPLETE KITS AVAILABLE FOR £14.0.0. (Carr. and ins. 3/- extra.)

A GENUINE SPECIAL OFFER!

This THREE SPEED AUTOCHANGER is by a famous manufacturer and is offered for **£9. 19. 6.** (Plus 7/6 carr. and ins.) Normal price £13.10.0. H.P. Terms

- 13.6.6. Dep. and 9 months at 16/11.
- Complete with High Fidelity Crystal "Turnover" Head which incorporates separate stylus for L.P. and 78 r.p.m. records.
- A "MIXER" Unit that will auto-change on 7in., 10in. and 12in. records.
- Brand New in Maker's Cartons, complete with instructions.

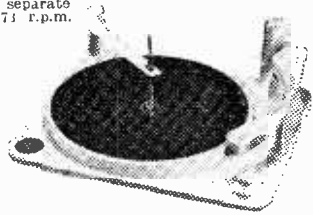

The "SUPER-SIX." A DESIGN FOR HOME CONSTRUCTORS

A compact and highly efficient superhet Radiogram chassis of outstanding quality for operation on A.C. mains. YOU CAN BUILD IT FOR £10.7.6. This receiver can be made to incorporate the new B.V.A. miniature valve line-up or the Octal valve line-up, and is designed to the very latest specification. Great attention has been paid to the quality of the reproduction of both Radio reception and Record playing, and excellent clarity of music is obtained. • Covers 3 wavebands. • Employs 6 valves having PUSH-PULL for 5-5 watts output. • Control operates on both Radio and Gram. THE INSTRUCTION & ASSEMBLY MANUAL is available for 1/6.



We can supply from Stock THE COLLARO 3-SPEED "Transcription" Players



MODEL 2010 with the NEW LIGHTWEIGHT "STUDIO P" CRYSTAL PICK-UP. PRICE £18.5.3 (plus 7/6 carriage and insurance). H.P. TERMS: Deposit £6/1.0 12 monthly payments of £1.2.4.

Send S.A.E. for our illustrated and descriptive leaflet

STERN RADIO LTD. 109 & 115 FLEET ST., E.C.4.

Telephone Central 5812/3/4

BUILD IN A BJ ARM

AND add fidelity to your installation

TANGENTIAL TRACKING MEANS —

- ☆ LESS WEAR
- ☆ EXTENDED response in both the high and lower frequency scale

"Practical Wireless" August issue says— test records appeared to sound even better than with our hitherto standard equipment, "rumble" which was previously audible on an organ test record, appeared non-existent. Every serious "hi fi" enthusiast should try to make this part of his installation.



BJ arm 44/11
Pur. Tax 15/-
BJ plug-in shell 17/3
Pur. Tax 5/9

Manufactured by

BURNE-JONES & CO., LTD., London, England

COMMUNICATIONS RECEIVER R.1155. Another purchase from the Air Ministry enables us to once again offer this superlative Communications Receiver at prices to suit every pocket. A World Station Getter, this covers 5 wave ranges: 18.5-7.5 mc/s, 7.5-3.0 mc/s, 1,500-800 kc/s, 500-200 kc/s, 200-75 kc/s, and is easily and simply adapted for mains use, full details with circuits of receiver being supplied. New in Maker's Cases and aerial tested. £11.19.6.
Dicto but slightly used for demonstration purposes. £9.19.6.
A.C. MAINS POWER PACK OUTPUT STAGE.—In black metal case enabling the receiver to be operated immediately without any modification, can be supplied as follows:—Less Speaker, £4.10.0; with 6in. P.M. Speaker, £5.5.0.
DEDUCT 10/- IF PURCHASING RECEIVER & POWER PACK TOGETHER.
 Please add carriage costs of 10/6 for Receiver and 3/6 for Power Pack.

POCKET VOLTMETERS, not ex-Govt.—Read 0.15 v. and 0-300 v. A.C. or D.C. BRAND NEW & UNUSED. ONLY 18/6.
CRYSTALS.—British Standard 2-pin 500 kc/s. 15-. Miniature 200 kc/s and 465 kc/s. 10/- each.
SPRAGUE.—1 mfd. 600 v. metal tubulars, 10d. ea. 9/6 dozen (add post).
R.F. UNITS TYPE 26 & 27.—For use with the R1355 or any receiver with a 6.3 v. supply. These are the Variable tuning units which use 2 valves EF54 and 1 of EC52. Type 26 covers 65-60 mc/s (5-6 metres) and Type 27 covers 85-65 mc/s (3.5-5.0 metres). Complete with valves and BRAND NEW IN MAKER'S CARTONS. ONLY 29/6 each.
CHOKES.—10H 60 mA, 4-, 5H 200 mA, 7/6, 10H 123 mA, 10/6 (post 3/- ea).

R.1132—A RECEIVER as described in the March and July issues for modifying to receive the Wrotham Transmissions. In very good order and complete with valves. ONLY 65/- (carriage, etc., 10/6).

POWER PACK TYPE 3.—Used by the Services with the above receiver, this is for 200/250 v. mains with output of 250 v. D.C. at 100 ma. and 6.3 v. 4 amps. Fitted with H.T. current meter and voltmeter. Tested working before despatch. ONLY 90/- (carriage, etc., 5/-).
 Connecting cable with Jones plugs for receiver and power pack. 10/-.

Amounts given for carriage refer to inland only.

U.E.I. CORPORATION 138, Gray's Inn Road, London, W.C.1
 (Phone: TEMple 7937)
 Open until 1 p.m. Saturdays. We are 2 mins. from High Holborn (Chancery Lane Station) and 5 mins. by bus from King's Cross.

SOLDERING ?

You can't beat a

PRIMAX!

70/-
post free

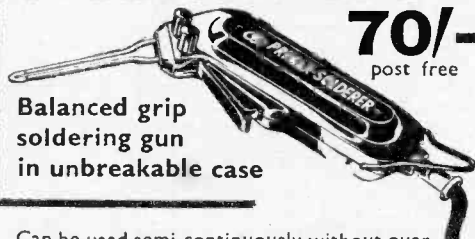

Balanced grip
soldering gun
in unbreakable case

Can be used semi-continuously without over-heating. Easy soldering on hard-to-reach jobs. Ready for action in 6 seconds. Permanent alloy tip—lasts indefinitely with normal use and care. Weighs only 24 ozs. Special loop for hanging. Available in 110, 200/220, 220/250 v. for A.C. only. 50/60 cycles (60 w.).

The ideal tool for any Radio—TV—Telephone Mechanic or Amateur. One Year's Guarantee

Sole Distributors:—

S. KEMPNER LTD.

(Dept. P.W.), 29, Paddington St., London, W.1

Phone: HUNTER 0755

REMOTE CONTROL FROM THE EXTENSION SPEAKER

A USEFUL UNIT FOR OPERATING THE MAIN RECEIVER FROM A REMOTE POINT

By K. V. R. Bowerman

PERHAPS, in addition to more serious listening on the main receiver, the family likes to hear the early morning programmes in the bedroom or the kitchen, and other programmes in the dining-room at meal times. All this can be done without going to the expense of buying a second receiver, and without the inconvenience of rushing from one room to another to change the programme. This system enables the listener to plug in to any extension speaker point and

- (1) Switch the main receiver on or off;
- (2) Select one of two programmes;
- (3) Control the volume of the extension speaker.

As well as the extension speaker lines, two extra leads are required. A length of flat twin flex is suggested.

The remote unit comprises an extension speaker, mounted in a cabinet, together with two push-buttons (bell-pushes would do), one toggle switch (SW1), one 5-ohm wire-wound volume control (VR1) and two 1-watt resistors of 54 K Ω each. At the main receiver (built into the cabinet, if there is room) is a unit comprising three G.P.O.-type 10,000-ohm relays RY1, RY2 and RY3, one further 54 K Ω resistor and a single-pole toggle switch SW2.

The Circuit

Fig. 1 shows a complete circuit suitable for either A.C. only or A.C./D.C. receivers. When used on,

A.C./D.C. receivers, care should be taken to ensure that the wiring, push switches, etc., are properly insulated, and that the remote unit is fully enclosed in a wooden cabinet.

RY1 has two pairs of change-over contacts RY1B and RY1C, and one pair of normally open contacts RY1A. RY2 has one pair of normally closed contacts RY2A. RY3 has two pairs of normally open contacts RY3A and RY3B. RY3 should be mounted, with the trimmer condensers (TC1 and TC2), on a bracket as close as possible to the main tuning condenser, so that the leads from these components can be kept extremely short. The wiring is otherwise quite straightforward.

The system operates as follows: button B1 is pressed and completes the mains circuit via lead 1, contacts RY1C, contacts RY2A, contacts RY1B, and lead 2. Transformer T1 is energised. As soon as H.T. is available from the rectifier, relay RY1 operates. RY1 closes contacts RY1A, which take over from button B1. The set is then switched on and will remain on for as long as RY1 is energised. Contacts RY1B and RY1C are arranged so that they change over immediately after contacts RY1A close. If button B2 is now pressed, relay RY2 operates and opens contacts RY2A, breaking the mains circuit and switching off the set. If the set is left on, operation of switch SW1 energises relay RY3.

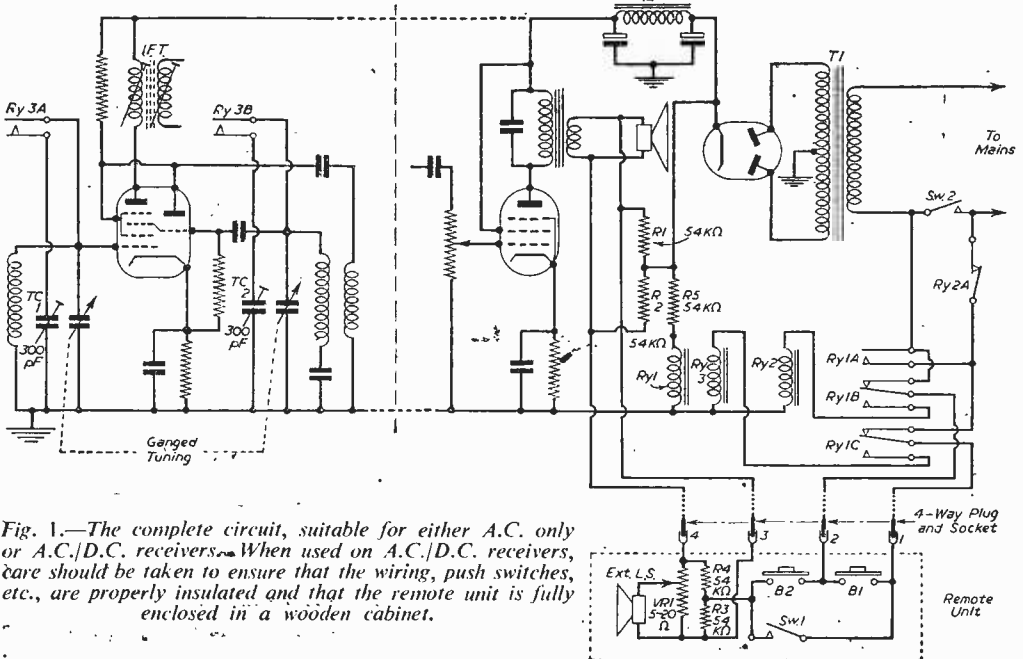

Fig. 1.—The complete circuit, suitable for either A.C. only or A.C./D.C. receivers. When used on A.C./D.C. receivers, care should be taken to ensure that the wiring, push switches, etc., are properly insulated and that the remote unit is fully enclosed in a wooden cabinet.

Contacts RY3A and RY3B close and trimmer condensers TC1 and TC2 (300 pF each) are thus placed in parallel with the main tuning condensers. TC1 and TC2 must be pre-set to add sufficient capacity to change the programme from the lower preferred wavelength to the higher. To set these trimmers, open contacts RY3A and RY3B by operating switch SW1, tune with the main condensers until the preferred lower wavelength (say, the Light Programme on 247 metres) is heard, then switch in the trimmers and adjust these together, a quarter-turn at a time, with a non-metallic trimming tool, until the preferred higher wavelength is heard (say, the Home Service on 330 metres). Re-adjust TC1 and then TC2 for maximum signal. Operation of SW1 will then select one programme or the other without any adjustment of the main tuning control. Switch SW2 disconnects the relay circuit and allows normal receiver operation when required.

It will be found, when tuning the receiver by the main tuning control, that the self-capacity of the relay contact arms and wiring introduces an error in the dial reading. This error, which is proportional to the amount of self-capacity present, can be considerably reduced by removing the standard paxolin wafers from the relay arm assembly and replacing these with wafers made from material of higher dielectric strength, such as Perspex. It is important to keep the contacts RY3A and RY3B clean and free of dust, otherwise crackling will occur. One way to ensure dust-free contacts is to enclose the entire relay in a polythene or cellophane bag.

Note resistors R1, R2, R3 and R4. These form a divider network which serves two purposes. First, in the unlikely event of any stray D.C. from the relay signal circuits finding its way via earth to the speech coils of the speakers, it would arrive at the ends of each coil in opposition and would thus cancel out. Secondly, these resistors together form, in effect, a series voltage-dropping resistor capable of carrying two watts and of total series value of 54 K Ω . This is the value required to limit the coil current of RY2 or RY3 to the correct value. R5 has a similar value and performs the same function for RY1. The value of VR1, the remote volume control, is not critical; 5 to 20 ohms, preferably logarithmic, would do.

When operating the remote control system, the receiver is, of course, left tuned to the lower preferred wavelength and the volume adjusted to normal level.

When the system is first put into operation, some adjustment to the tensioning of the relay contacts may be required. In particular, there may be a tendency to "trembler-bell" action on relays RY1 and RY2. This can easily be put right by ensuring that contacts RY1A close well before contacts RY1B and RY1C change over, and by adjusting contacts RY1A so that they are only lightly sprung against the pull of the relay arm. Make sure that contacts RY2A are also lightly sprung. When adjusting relay contacts, use small snipe-nosed pliers and bend the contact springs only at the root (i.e., where they enter the paxolin strips). Before operating buttons B1 or B2, always turn switch SW1 to the "open" position (lower preferred wavelength).

RUGBY RADIO EXTENSION

THE Postmaster-General, the Rt. Hon. Charles Hill, M.P., recently opened a large extension of Rugby Radio Station in Warwickshire.

The station was opened in 1926 originally, for the transmission of radio-telegraph messages on a wavelength of 18,750 metres, its call-sign being GBR. With the advent of short-wave communications, telephone and telegraph transmitters, working on wavelengths of between 10 and 100 metres, were installed in a new building and beam aerials covered the 900-acre site. For the past twenty-five years, telephone and telegraph messages have been transmitted from Rugby on short wave to all parts of the globe and the demand for these services grew so much that it became necessary to add a considerable extension to the station, in spite of additions made during the war.

The old station and the new station now cover 1,600 acres of land. Twenty-eight high-power radio transmitters are housed in the middle of the site in a specially-designed building, which will eventually be surrounded by about

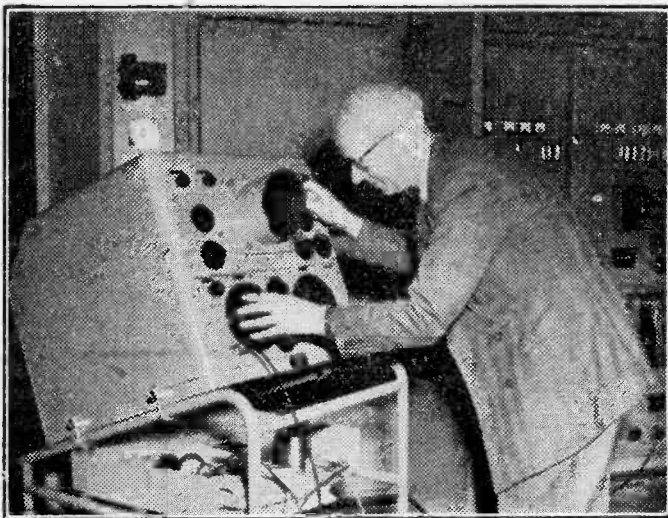

Mr. B. R. Hutton-Penman, an executive engineer, studies a "Spectrum Analyser," an instrument used for checking transmitter performances.

100 aerials radiating signals to all points of the compass. The new extension has involved a great amount of intensive planning and

has taken three years to build. It has been estimated that the final cost will be more than £1,000,000

**Build this
HIGH
QUALITY
LOW COST
AMPLIFIER**

★ Circuit designed by Mullard research engineers.

★ Specified components available from most radio dealers.

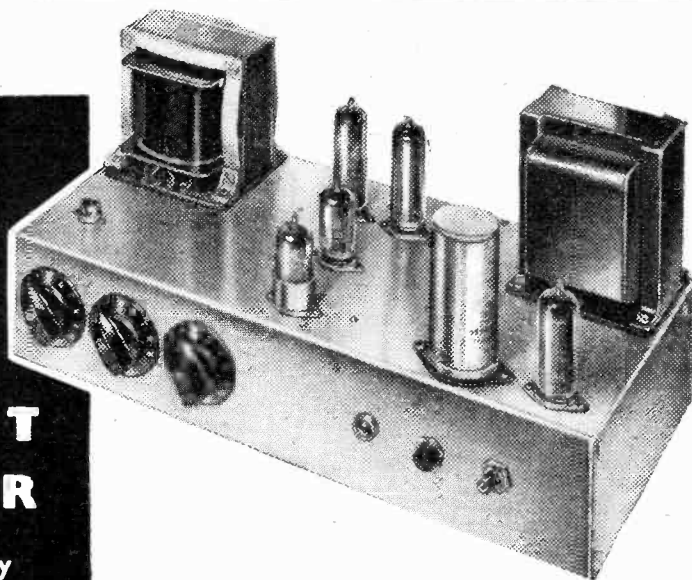

Here's an entirely new amplifier circuit which brings high quality sound reproduction within the reach of thousands more enthusiasts. It has been

designed by Mullard research engineers with special regard for easy construction and low cost.

Full details of the circuit are included in the 2s. 6d. book which is obtainable from radio dealers or direct from Mullard Ltd. Valve Sales Department—2s. 10d. post free. Get your copy now.



EASY TO BUILD AT LOW COST	GOOD TRANSIENT RESPONSE	LOW OUTPUT RESISTANCE	LOW HUM AND NOISE
NEGLECTIBLE DISTORTION AT ALL OUTPUT LEVELS	DESIGNED ROUND FIVE MULLARD MASTER VALVES EF86 ECC83 2 x EL84 GZ30 or EZ80		UNIFORM FREQUENCY RESPONSE IN AUDIBLE RANGE



MULLARD LTD., CENTURY HOUSE, SHAFTESBURY AVENUE, LONDON, W.C.2

MVM3 8C

PRECISION BUILT MATCHED COMPONENTS

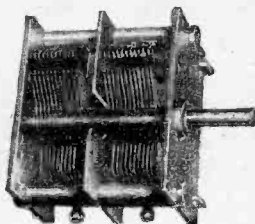
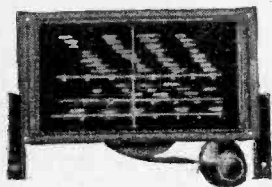

S.L.8 SPIN WHEEL DRIVE

A precision slide rule drive. Complete with 3-band glass scale, 9in. x 4 $\frac{1}{2}$ in. Printed—short, medium and long wave bands with station names. Scale length 7in.

The spin wheel drive gives easy control through a ratio of 24-1. Fitted with constant velocity coupling, eliminating strain on the Condenser, and providing mechanical and electrical isolation from vibration and noise.

Supplied with florentine bronze escutcheon. Price—27/6d. complete.

M.E. GANG CONDENSER

Available as 1, 2 or 3 gang, 490 p.F. nominal capacity, matched and standardised to close limits. Supplied with trimmers if required. Other capacities available—details on request.

Cadmium plated steel frame.
Aluminium Vanes.
Low loss, non-hygroscopic insulation.
Spindle $\frac{1}{8}$ in. dia. projects $1\frac{1}{8}$ in. from front plate.
Front area 2 $\frac{1}{2}$ in. x 2 $\frac{1}{2}$ in. including sweep of vanes.

Length excluding spindle :
1 gang—1 $\frac{7}{8}$ in.
2 gang—2 $\frac{1}{8}$ in.
3 gang—3 $\frac{1}{8}$ in.

Price
9/3d.
14/-d.
18/3d.

★ Write for fully illustrated catalogue

JACKSON

BROS. (LONDON) LTD.
KINGSWAY · WADDON · SURREY

Telegrams:
WALFILCO, SOUPHONE, LONDON
Telephone: CROYDON 2754-5.



L7381

FREE TO AMBITIOUS ENGINEERS!

This 144-page Book

Have you sent for your copy ?

'ENGINEERING OPPORTUNITIES'

is a highly informative guide to the best-paid Engineering posts. It tells you how you can quickly prepare at home on "NO PASS—NO FEE" terms for a recognised engineering qualification, outlines the widest range of modern Home-Study Courses in all branches of Engineering and explains the benefits of our Employment Dept. If you're earning less than £15 a week you cannot afford to miss reading this unique book. Send for your copy to-day—FREE.

--- FREE COUPON ---
Please send me your FREE 144-page "ENGINEERING OPPORTUNITIES"

NAME
ADDRESS

Subject or Exam. that interests me
British Institute of Engineering Technology,
409B, College House, 29-31, Wright's Lane,
Kensington, W.8.

WHICH IS YOUR PET SUBJECT?

Mechanical Eng.
Electrical Eng.
Civil Engineering
Radio Engineering
Automobile Eng.
Aeronautical Eng.
Production Eng.
Building, Plastics,
Draftsmanship
Television, etc.

GET SOME LETTERS AFTER YOUR NAME!
A.M.I.Mech.E.
A.M.I.C.E.
A.M.I.P.E.
A.M.I.M.I.
L.I.O.B.
A.F.R.Ae.S.
B.Sc.
A.M.Bric.I.R.E.
CITY & GUILDS
GEN. CERT
OF EDUCATION
etc., etc.

Electrical Interference?

IF YOUR RADIO RECEPTION IS MARRED BY NOISE FIT AN

EDDYSTONE MAINS FILTER



Cat. No. 732, specially designed for use with receivers covering short and medium wavelengths, this well screened Filter Unit is most effective in suppressing mainsborne electrical interference. Finished ripple brown and supplied complete with flexible lead and socket.

£2 15s. 0d.

For address of nearest stockist please write :
STRATTON & CO. LTD.
ALVECHURCH ROAD, BIRMINGHAM 31

BIET

Tape Erase and Bias Oscillator

USE OF TWIN-T NETWORK FOR DISTORTION-FREE WAVEFORM

By Hugh Guy

ONE aspect of recording on tape that does not receive the attention it merits concerns the source of bias and erasure. Volumes have been written on recording and equalising characteristics in the past few years and the circuits to produce such characteristics are now familiar to the recording enthusiast. Suppression of hum, too, is fully dealt with in the literature, but apart from recommending the use of low-noise valves in the high-gain stages of the amplifiers suggestions on the reduction of noise and recording "hiss" are seldom dealt with.

In recent years tape recording has developed into an art which compares favourably with and in some cases is superior to disc recording, and to the "hi-fi" amateur who desires the best from his recordings the noise problem can be serious.

Bias and Erase Current

It is common practice to provide the bias and erase currents from the same source. The frequency of this source is dependent to a certain extent on the bandwidth of the recording amplifier; if a relatively low frequency were to be used, say, 15 kc/s, then signals from the recording amplifier of about this frequency would "beat" with the 15 kc/s signal, producing an undesirable modulation which could appear as a signal on the tape. Not only would the fundamental note produce these modulated superfluous signals, but harmonics of lower frequencies, if they were of the order of 15 kc/s, would have the same effect. Because of this it is customary to fix the bias source at something greater than the third harmonic of the highest recordable frequency, and in consequence bias frequencies of less than 50 kc/s are seldom encountered.

From an erase current point of view, then, the lower limit is fixed only by the number of excursions it is desirable for any magnetic particle in the tape to make through its demagnetising cycle. Each particle should, of course, make several such excursions to ensure complete removal of any signal. Imagine, for example, that the erase head gap width is 2.5 thousands of an inch, i.e., 0.0025in., and that the tape travels with a velocity of 7½ in. per second. Then the time taken for any particle to cross the gap is $\frac{2.5}{7.5}$ milliseconds. This corresponds to a frequency of 3,000 c.p.s., and therefore for a minimum of 10 erasing cycles a frequency of 30 kc/s would be required.

Within reason, the higher the erase frequency the better, but there is no advantage in exceeding 100 kc/s if the tape speed is 7½ in. per sec., as the losses in the material of the erase head become too high, causing unnecessary heating, etc.

Oscillator Waveform and Noise

Briefly, then, the above considerations determine the frequency of the source. Now, the oscillator producing the bias and erase current must have a perfectly symmetrical sine-wave output. This is essential in order that each particle is carried smoothly through the magnetisation cycle and left with zero remanence; that is, no flux remains in the particles.

A poor waveshape will not produce this effect. In fact, a sine-wave possesses this property only because its rate of change is constant and perfectly smooth, and its mean value is zero.

Any amateur who has used a permanent magnet for erasing will know the effect of asymmetrical erasure. The background noise is very high, and the amount of signal that can be recorded without overloading the tape is considerably lower than the level obtainable when sinusoidal erasure is used. Consequently, a very poor signal-noise ratio results which detracts seriously from pleasurable listening.

To a lesser extent the bulk of the single-stage oscillators normally used in the simpler type of bias and erase oscillator also suffer from the same defect. In this case it is generally the poor waveshape that contributes to the noise.

With single-stage oscillators it is almost impossible to feed bias and erase currents to the respective heads without loading the oscillator circuit elements and distorting the waveform. True, it can be achieved, but an oscilloscope is required to monitor the waveform while the heads are tuned and the oscillator circuit modified to maintain a sine-wave output. And even then the whole procedure must be repeated when a different tape requiring a new optimum value of bias is used.

By far the best kind of oscillator is the type in which one or two stages are devoted to the generation of the sine-wave, followed by a further stage of power amplification to provide the 3-4 watts output at the desired frequency. Certain classes of professional recording apparatus do use such a system.

An even better refinement consists of including the power amplifier in a balanced feedback amplifier, which also includes the oscillator stage. This type of circuit results in greatly increased stability and ease of adjustment.

From a constructor's point of view also it would

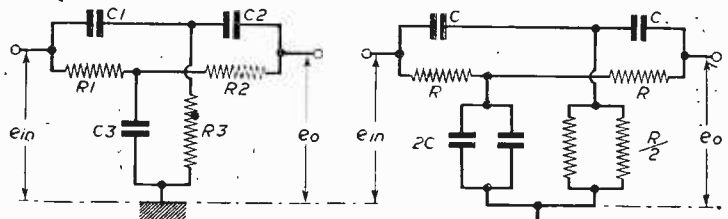

Fig. 1(a) (left).—Twin-T network. Fig. 1(b) (right).—Convenient form of Twin-T.

be far simpler if the coils normally associated with such an oscillator were dispensed with. This saves a great deal of inconvenience and in the long run assists in producing a purer sine-wave, since inductances are inclined to be rather particular about the amount of current they carry.

The frequency conscious elements, or in other words the components which determine the frequency of oscillation of the circuit, should consist therefore

The next problem is how can we use a network with such a characteristic to produce oscillations. The characteristic is completely opposite to, say, a parallel-tuned LC circuit and, therefore, cannot be used in the oscillator of the LC type. In fact, a simple equivalent circuit to the twin-T network is shown in Fig. 3, where it is seen to resemble a series-tuned circuit. At very low frequencies the reactance of the condenser C is high, and the output e_o is, therefore, a large proportion of the input. This is also the case at high frequencies where the reactance of the inductance is high. At some middle frequency, however, the impedance of the LC combination is zero, and here the output will be nothing and the overall transfer characteristic is, therefore, similar to that of the twin-T network in Fig. 2.

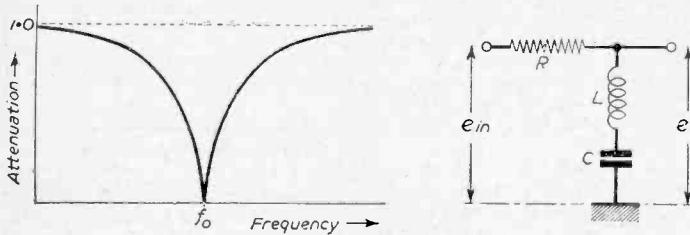

Fig. 2 (left).—Frequency characteristic of the Twin-T network. Fig. 3 (right).—Approximate equivalent circuit.

only of condensers and resistors. A special bridge circuit does exist which can be used for such a purpose and, as this circuit has numerous applications in the A.F. field, it is worth while discussing it separately.

Twin-T Network

Fig. 1(a) shows the circuit of the bridge and, from its general appearance, the name by which it is generally known, the Twin-T network, is rather appropriate.

The transfer characteristic of the network is shown in Fig. 2. Here we see that all of the input signal passes with practically no attenuation to the output, except for the frequencies in one band. In the middle of this band there is zero output and this mid-band frequency is known, somewhat erroneously, as the resonant frequency (symbol f_0) of the network.

Now not any random combination of resistor and condenser will produce this effect; the values of the components must bear a distinct relationship one to the other.

The most general condition is given below:—

If $\omega\omega^2 C_1 C_2 R_1 R_2 = k$, where $\omega\omega = 2\pi f_0$, and k is a constant

$$\text{then } R_z = \frac{1}{k} \left(\frac{R_1 R_2}{R_1 + R_2} \right) \text{ and } C_z = \frac{1}{k} (C_1 + C_2)$$

By happy coincidence, one of those flukes which so rarely happen in the field of radio engineering occurs if we make R_1 and R_2 equal, and C_1 and C_2 equal, and if we put k equal to 1.

This formula then reduces to the following:

$$\omega\omega CR = 1, \text{ where } C_1 = C_2 = C, \text{ and } R_1 = R_2 = R$$

$$\text{Thus } f_0 = \frac{1}{2\pi CR} \text{ and } R_3 = \frac{R}{2} \text{ and } C_3 = 2C.$$

and the beauty of this solution is appreciated when Fig. 1(b) is examined.

In this arrangement R_3 is produced by connecting two of the R value resistors in parallel, giving $R/2$. The same is done with the C value condensers, this time to give $2C$.

Thus, a great deal of trouble is avoided in finding values for R_3 and C_3 , which would otherwise be unobtainable in the standard range of components due to the awkwardness of values invariably resulting from the general formula.

Using the Twin-T

To be of any use this characteristic should be inverted so that at one particular frequency maximum positive feedback could exist and this would determine the frequency of oscillation of any circuit in which the network were connected.

This can be accomplished by having both positive and negative feedback paths in an amplifier (see Fig. 4). The positive feedback path contains no frequency conscious elements and the signal fed back is, therefore, constant in amplitude over the pass-band of the amplifier. The negative feedback, however, is applied via the twin-T network and, therefore, all the output of the amplifier is fed back except that portion of the bandwidth which is attenuated by the network. If a control is incorporated in the positive path to maintain the positive feedback less than the negative feedback, then only when there is no negative feedback, i.e., at the null-frequency of the twin-T network, will that in the positive path gain control and set the circuit oscillating.

What the circuit does, in fact, is subtract a humped negative characteristic from a flat characteristic in a "difference" amplifying circuit, giving a humped positive response to a positive feedback path.

(Continued on page 625)

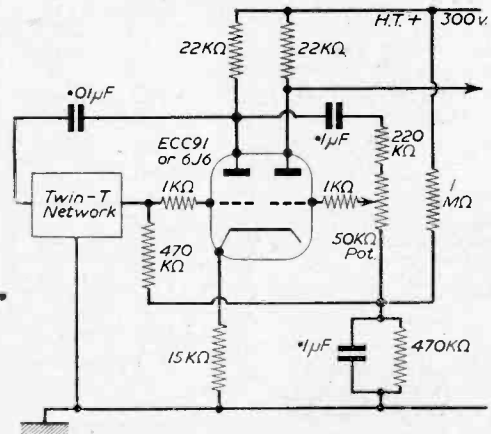

Fig. 4.—Basic Twin-T oscillator.

BAND 3 T/V CONVERTER—186 Mc/s. - 196 Mc/s. £2-5-0 post free.



This Unit, which is a slightly modified version of the circuit shown in Wireless World, May, 1954, has proved itself highly successful—over 1,000 sets sold in one month to buyers all over England. We invite you to visit us and see it in operation for yourselves. Blue print and circuit details will be sent on application by return of post. 1/6, post free.

Kit of parts comprises drilled chassis, 7" x 4" x 2½", valves, wound coils, etc. Supply voltages

200-250 mA H.T. 6.3 v. 1 a. L.T. Suitable for all types of T/V sets, T.R.F. or Superhet and all channels, 42 Mc/s - 68 Mc/s.

Complete set wired and tested ready for use. 15/- extra. Power pack components to fit chassis, 30/- extra.

Full component list available. Drilled chassis and screen, 9/6; four wound coils and knob, 10/-, etc.

Volume Controls

Midget Edlwan type. Long spindles. Guaranteed 1 year. All values 10,000 ohms to 2 Meg-ohms.
No Sw. S.P.Sw. D.P.Sw. 4/- 4/- ... 1/2
3/- 4/- ... 1/2
COAX PLUGS ... 1/2
SOCKETS ... 1/-
COUPLER ... 1/3
OUTLET BOXES ... 4/6

80 ohm COAX

STANDARD 1in. diam. Polythene insulated. GRADE "A" ONLY.

8d. yd.

SPECIAL — Semi-air spaced polythene, 80 ohm Coax 1in. diam. Stranded core. Losses cut 50%.
9d. yd.

BALANCED TWIN FEEDER per yd. 6d. 1/2 80
TWIN SCREENED FEEDER per yd. 1in. dia. 100 pf. 150 pf. 1/3; 250 pf. 1/6; 600 pf. 1/9. PHILIPS Beelive Type—2 to 8 pf. or 3 to 30 pf. 1/3 each. RESISTORS.—Pref. values 10 ohms 10 megohms.

CARBON 20% Type. 1 w. 3d. 1 w. 5d. 1 w. 6d. 2 w. 9d. 10% Type. 1 w. 1/- 1% Hi-Stab. 1 w. 2/-
WIRE WOUND 5 w. 25 ohm—1/3 10 w. 10,000 1/8 15 w. ohms 2/- 3 w. 15,000—1/9 10 w. 33,000 2/3 10 w. ohms 2/3
3w. LAB COLVERN, Etc. Standard Size Pots, 2 1/2in. Spindle. High Grade. All Values. 100 ohms to 50 K., 5/8; 100 K., 6/8. W/W EXT. SPEAKER CONTROL 10 Ω. 3/-.

CONDENSERS—Mica, S. Mica, Ceramics. All pref. values. 3 pf. to 650 pf., 6d. ea. Tubulars, 450 v. Hunts and T.C.C. .0003, .001, .005, .01, .02 and 1.250 v. 9d., .05, 1.500 v. Hunts Moulscel, 1/-, .25 Hunts, 1/6. .5 Hunts, 1/8. 1.500 v. T.C.C. (Simplex), 3/8. .001, 0.5 v. T.C.C., 5/8. .001 12.5 kV. T.C.C., 9/8.

SILVER MICA CONDENSERS—10%. 5 pf. to 500 pf., 1/-, 600 pf. to 3,000 pf., 1/3. 1% 1.5 pf. to 500 pf., 1/8. 315 pf. to 3,000 pf., 2/-.

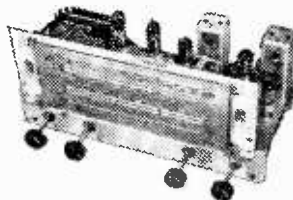

ALL WAVE RADIOGRAM CHASSIS

THREE WAVEBANDS FIVE VALVES
S.W. 16 m.—50 m. B.V.A.
M.W. 200 m.—550 m. B.V.A.
L.W. 600 m.—2,000 m. SERIES.

Brand New and Guaranteed. A.C. 200/250 v. Four position Wavechange Switch. Short-Medium-Long-Gran. Pick-up connections. High Q iron-tube-cored coils. Latest circuit technique, delayed A.V.C. and Negative feedback. Output approx. 4 watt. Chassis size 13 1/2 x 5 1/2 x 2 1/2 in. Glass Dial—10in. x 4 1/2 in. horizontal or vertical type available, lit by 4 Pilot Lamps. Four Knobs supplied. Walnut or Ivory to choice, aligned and calibrated ready for use. Chassis isolated from mains. PRICE £9. 15. 0 Carriage and Insurance, 4/6. £9. 15. 0 8in. or 10in. speakers to match available.

BARGAIN VALUE IN RECORD CHANGERS

Recommended for above chassis
E.S. MONARCH—Latest Model 7 sp. Auto-Changer Mixer Unit. Famous Magdiline, 7, 10 and 12in. Record Selector. Modern Cream Styling Dual Xtal Cartridge Stylus for Hi-FI reproduction. As used by leading manufacturers. Bargain Price.

9 1/2 Gns. post free.

ELECTROLYTICS ALL TYPES NEW STOCK

Tubular Wire ends	1/9	8+10/450 v. Hunts	5/-
25/25 v., 50/12 v.	2/1	16+16/275 v. T.C.C.	4/6
50/50 v., 4/500 v.	2/-	16+16/450 v. B.E.C.	5/8
100 25 v.	2/1	16+16/460 v. T.C.C.	6/-
8/500 v., Dub.	2/6	16+24/350 v. B.E.C.	5/-
8+8 500 v. Dub.	4/6	32/350 v. B.E.C.	4/-
8+8 450 v. Hunts	5/-	32+32/450v. B.E.C.	6/8
16/450 v. B.E.C.	3/6	60/350 v. B.E.C.	6/8
16+16/450 v. T.C.C.	5/6	60+100/350 v.	11/6
32/350 v. B.E.C.	4/-	60+250/275 v.	12/6
32+32/500 v. Dub.	5/-	100+250/273 v. B.E.C.	12/6
32+32/500 v. Dub.	7/6	1000+1000/6 v. B.E.C.	6/6
Can Types, Clips, 3d. ea.		500 mfd. 12 v.	3/-
8+8/450 v. T.C.C.	4/6		

MAINS TRANSFORMERS

—Made in our own Workshops to Top Grade spec. Fully interleaved and impregnated. RADIO AND AMPLIFIER TYPE.—250 v., 60 ma. P.W. sec., 5 v. or 6.3 v. 1 a. rect. 6.3 v. 2.5 a. set Htrn. 21/-, etc. C.R.T. HTR. ISOLATION TYPE.—Low leakage with or without 25% sec. boost voltage. Ratio 1:1 or 1:1.25, 2.5, 10/6; 4 v., 10/6; 6.3 v., 10/6; 15.3 v., 10/6. Ditto with mains primaries 200/250 v., 12/8. Specials to order. SPECIAL TYPES.—To designers spec. Simplex, 35/-; Viewmaster, 35/-; Lynx, 30/-; P/W Tape Deck, 22/6; Soundmaster, 25/-; Mullard Anop., 35/-; Osram 912, 35/-; HEATER TRANS.—Prim. 200/250 v. 6.3 v. 1 a. or 4 v. 2 a., or 12 v. 15 a., 7/6; 6.3 v. 3 a. or 5 v. 3 a. or 4 v. 4 a., 10/8.

10 F. CHOSES—10 H. 65 ma., 5/-; 15 H. 100 ma., 10/6; 10 H. 120 ma., 10/8; 20 H. 150 ma., 15/6; Simplex, 10/6; Soundmaster, 10/6; P/W Q.R. 6/6; P/W Quality 9 Gram., 35/-; Osram 912 -cathionised windings, £3.10.0. Mfrs. surplus types, standard pentode, 4/6; ditto tapped prim., 4/9; small pentode, 3/9; Midget battery pentode (154, 3V4, etc.), 4/8.

SOLENOID SOLDERING IRONS (200-220v. or 230-250v.) 25 watt, instrument type, 19/6; 65 watt, Pencil Bit Type, 25/-; 65 watt, Oval Bit Type, 23/- Comprehensive stock of spares available.

CRYSTAL DIODE—Very sensitive. G.E.C., 2/-.

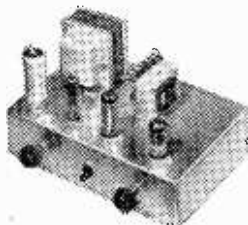

3 VALVE AMPLIFIER

With variable Tone and Volume controls. 3 Midget B.V.A. valves. 4 watts output. Neg. feedback. Chassis isolated from Mains. A.C.200/250 v. A quality amplifier at an economical price. PRICE £3.19.8. Carr. 2/6. Wired and tested, 7/6 extra. Blueprint, circuit and instr. 1/6 (free with kit).

NEW VALVES GUARANTEED ALL BOXED

1R5	7/6	6Q7	8/8	EF41	10/8	MC14	8/6
185	7/6	68N7	9/-	12F59	10/-	PCCS4	12/6
1T4	7/6	8V4	7/6	Multard	10/-	PCF80	12/6
1A4	7/6	6X4	8/6	EF50	10/-	PCF82	12/6
384	8/-	6X5	8/-	Equip.	5/6	PLS1	12/6
3V4	8/-	EA50	2/-	EF80	10/6	PLS2	10/-
3D6	3/6	EB41	10/6	EF86	13/6	PLS3	12/6
5Z4	8/6	EB91	7/6	EP91	8/6	PS80	11/-
6AM6	8/6	EB33	8/6	EL41	11/6	PS82	10/-
6AT6	8/6	EX383	12/6	EL84	12/6	SP41	5/6
6CH6	10/6	EX42	10/6	EM80	12/6	SP61	6/6
6H6M	3/6	EX48	12/6	EY81	12/6	U22	5/6
6K7	6/6	ECL80	12/6	EZ40	10/-	U25	12/6
6X8	9/-	EF39	7/6	LY24	4/-	etc.	etc.

SPECIAL PRICE PER SET
1R5, 1T4, 185, and 384 or 3V4... 27/6
6K6, 6K7, 6Q7, 8V4, 2Z4 or 3Z4... 35/-
SPEAKER FRET—Expanded Bronze anodised metal 8in. x 8in., 2/3; 12in. x 8in., 3/-; 12in. x 12in., 4/3; 12in. x 16in., 6/-; 24in. x 12in., 8/6, etc.
TYGAN FRET (Murphy pattern).—12in. x 12in., 2/-; 12in. x 16in., 3/-; 12in. x 24in., 4/-; etc., etc.

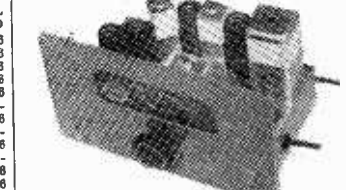

F.M. TUNER-UNIT (87 mc/s—105 mc/s), by Jason. —As tested and approved by Radio Constructor. Complete kit of parts to build this modern highly successful unit, drilled chassis and J.B. dial, coils and cans. 4 BVA miniature valves and all components etc., for only 26.10.0, post free. SUPERIOR TYPE GLASS DIAL.—Calibrated in Mc/s and edge lit by 2 pilot lamps, 12/6 extra. Illustrated handbook with full details, 2/-, post free.



RADIO COMPONENT SPECIALISTS (THO. 2188) 70 BRIGSTOCK ROAD, THORNTON HEATH, SURREY

Buses 130A, 133, 159, 166 & 190

Send 3d. stamp for Bargain Lists Hours: 9 a.m.—6 p.m. 1 p.m. Wed. OPEN ALL DAY SAT

S.B.—Terms C.W.O. or C.O.D. Post/Packing up to 1 lb. 6d., 1 lb. 1/-, 3 lb. 1/6, 5 lb. 2/-, 10 lb. 2/6.

Turn SPARE time to CASH!

PROFESSIONAL 3 VALVE MAINS SET IN SUPERB CABINET FOR ONLY . .

A straight T.R.F. A.C. or A.C./D.C. Mains Set—requires no radio knowledge to assemble. Easy to read Diagram takes you step by step. Only tools needed are pliers, Screwdriver and Soldering Iron. ALL parts in stock NOW. Order AT ONCE stating which type of set is required A.C. or A.C./D.C. Mains—these are the sets to SHOW to FRIENDS!

Wiring Diagram and Parts List, 1/-, Post FREE

97/6
PLUS 2/6 FOR Postage & Packing.

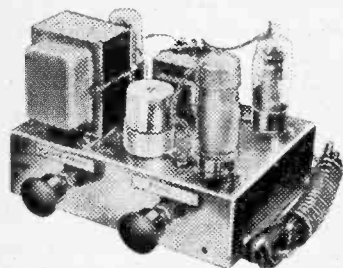

63/-
ONLY

PLUS 2/ FOR Postage & Packing.

EASY TO READ WIRING CHART AND PARTS LIST 6d. (Post Free.)

FOR THIS MULTI-PURPOSE AMPLIFIER UNIT KIT!

The CHEAPEST 3-Valve Amplifier on the market—can be built in 2-3 hours WITHOUT previous radio experience! High Gain. Negative Feedback and Ready-drilled Chassis which is not "live." Ideal for amplifying Grams, small P.A. Equipment, Baby Alarms, Office Intercom Sets, etc. An ABSOLUTE BARGAIN at this price—get YOUR order in NOW to avoid disappointment!

SATISFACTION OR CASH REFUNDED!

WRITE NOW TO B'HAM'S LARGEST WALK-AROUND RADIO STORES!

NORMAN H. FIELD MAIL ORDERS: 97, STRATFORD RD., BIRMINGHAM, 11. Tel. 3619
CALLERS: 68, HURST STREET, BIRMINGHAM, 5. Mid 3619

Rylee

- T/V TECHNOLOGY
- RADIO ENGINEERING
- ELECTRONICS
- RADIO SERVICING

There's a big future in T/V and Radio. Act now! Increase your knowledge. Back up experience with a sound theoretical background. I.C.S. offer courses of instruction in—

- T/V TECHNOLOGY
- ADVANCED SHORT-WAVE RADIO
- RADIO ENGINEERING
- RADIO SERVICE ENGINEERING
- RADAR
- ELECTRONICS
- FREQUENCY MODULATION

I.C.S. will also coach you for the following examinations:—
B.I.R.E.; P.M.G. Certificate for Wireless Operators; Radio Servicing Certificate (R.T.E.B.); C. & G. Telecommunications, etc., etc.

DON'T DELAY—WRITE TO-DAY for free descriptive booklet, stating which subject or examination interests you. Fees include all books needed. Examination students coached until successful. Reduced terms for H.M. Forces.

Dept. 170D, I.C.S., 71, Kingsway, W.C.2.

INTERNATIONAL CORRESPONDENCE SCHOOLS—
(Dept. 170D), International Buildings, Kingsway, London, W.C.2.

Please send booklet on.....
Name..... Age.....
(Block letters, please)
Address



REPANCO HIGH GAIN COILS

DUAL RANGE MINIATURE CRYSTAL SET COIL, with circuit. Type DRX1, 2/6.

DUAL RANGE COIL with reaction. With 2 mains and 2 battery circuits. Type DRR2, 4/-.

MATCHED PAIR DUAL RANGE T.R.F. COILS, with reaction; with battery and mains circuits. Type DRM3 8/- pair. (Regd. Design)



STANDARD I.F. TRANSFORMERS. Type S.E. 1 1/2 in x 1 in. x 2 1/2 in. Pre-aligned, 465 kc/s., 13/6 pair.

MINIATURE I.F. TRANSFORMERS. Type M.S.E. 1 3/16 in. x 1 3/16 in. x 1 1/2 in. Pre-aligned, 465 Kc/s., 12/6 pair.

FERRITE ROD AERIAL. Type FR1. Long and medium wave. Complete with fixing brackets, 12/6.

- ★ All coils wound on low loss formers.
- ★ Individually tested and guaranteed.

★ Post 3d. on all orders. ★ Trade supplied.

Distributed by:
RADIO EXPERIMENTAL PRODUCTS LTD.
33, MUCH PARK STREET, COVENTRY
Telephone: Coventry 62572

The circuit has no option, therefore, but to oscillate and that of Fig. 4 responds in this manner. Before describing this circuit though it is worth while mentioning one or two other uses to which the network may be put.

Filter

Its most obvious use is as a filter, particularly for the removal of mains hum. The twin-T network

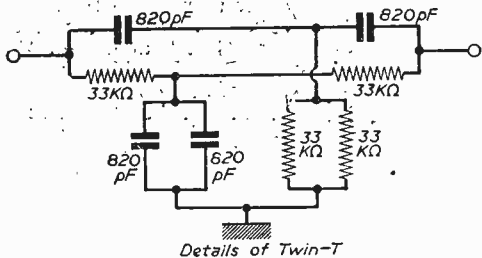

Details of Twin-T

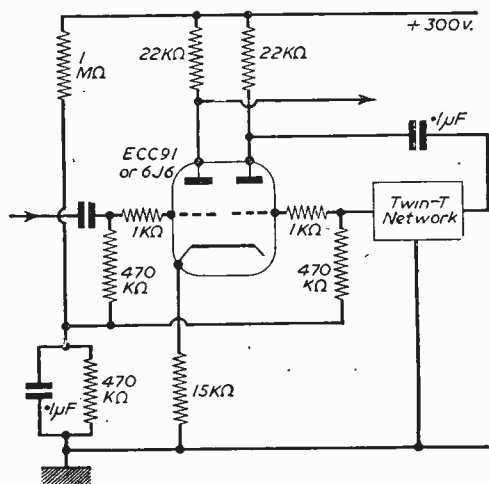

Fig. 5(a).—Twin-T treble equaliser for tape recorder.

may be connected in series with the output from the rectifier of a normal power supply. The regulation will be worsened as a result, but the hum reduction provided makes the arrangement particularly advantageous if the power pack is to be used as a bias supply.

In this connection, if full-wave rectification is to be used, then the resonant frequency will be 100 c.p.s.

and consequently $f_0 = \frac{1}{2\pi CR} = 100$. Thus, if C is in μF and R in k Ω then the product CR=1.6. The best practical values to produce this product are C=0.5 μF , and R=3.3 k. giving a resonant frequency of 96.5 c.p.s. The attenuation at 100 c.p.s. is still, nevertheless, 35 dBs, despite the use of inexact values.

For half-wave rectification CR=3.2 and suitable values, once again compromising, are C=1 μF , and R=3.3 k. It must be remembered that, in each case, the vertical arms of the "T" consist of two resistors of value R in parallel, and two condensers, value C, in parallel.

A second frequently used application of the network is in tone control and compensation networks. The

treble response of the recording characteristic of tape can be improved in the playback amplifier by the type of circuit shown in Fig. 5(a). Assuming the resonant frequency needs to be 6 kc/s, then CR = 0.0265, and the improved characteristic is shown in Fig. 5(b). This circuit again subtracts two characteristics to give a boost rather than a cut at the resonant frequency and the similarity between the equaliser and that of the oscillator shows the circuit's versatility and should give the enthusiast a very adaptable unit for testing and improving his tape recorder while it is in the process of construction.

The twin-T network is by no means the best sort of equaliser to use for this purpose and its one major disadvantage is that the resonant frequency cannot easily be made variable. Furthermore, the steepness of the "cut" or "boost" is not very great and should a steep characteristic be required then a similar circuit using an inductance and known as the bridged-T circuit is more applicable.

For the oscillator we have considered, however, it is not necessary to vary the frequency and since the circuit avoids the use of inductances and gives a very pure waveform then the twin-T network is ideally suitable.

The Oscillator

The circuit of Fig. 4 provides a very pure sine wave at the right-hand anode when the feedback control (the 50 k. potentiometer) is adjusted so that oscillation just commences. As it stands, however, the stage would be incapable of delivering the necessary power to an erase head and must therefore be followed by a power amplifier.

It would be a simple matter to connect, say, a 6V6 output tetrode to follow the oscillator circuit shown in Fig. 4, and this can in fact be done. The grid of the tetrode should be coupled via a 0.01 μF condenser and a 0.5 M Ω potentiometer, the slide of the latter forming the take-off point for the grid. This control is included to attenuate the 100 volts peak-to-peak output produced at the right-hand anode of the oscillator, approximately 25 volts drive being required for the 6V6.

The output is taken from the anode of the 6V6 via a suitable coupling transformer, the ratio of which will be determined by the impedance of the erase head which should be tuned by means of a suitable coupling condenser. This series tuning permits the maximum amount of current to flow in the erase head, and since the demagnetising field produced by this head is proportional to the current flowing through it, tuning ensures efficient erasure.

The one drawback with this circuit is that distortion occurring in the power amplifier is not corrected, and a good waveshape would only result when the

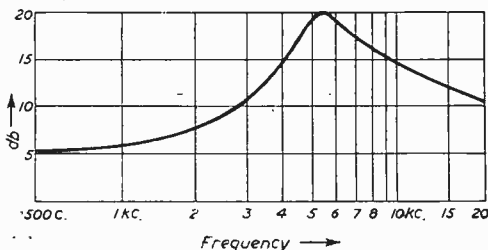

Fig. 5(b).—Measured response of equaliser.

0.5 MΩ potentiometer was set near its anti-clockwise end (i.e., near minimum drive).

To overcome this, the circuit of Fig. 6 was finally developed. The basic circuit of Fig. 4 is still used, but here the output stage is included in the feedback chain. A connection is made to the anode of the 6V6 output tetrode and positive feedback applied through the 330 k. resistor and 25 k. variable control to one grid, whilst negative feedback is applied

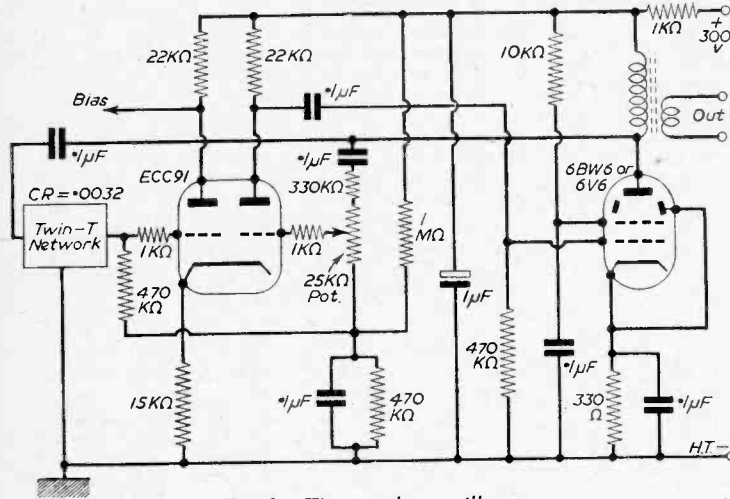

Fig. 6.—The complete oscillator.

through the twin-T network to the other grid of the double-triode amplifier. With this arrangement any harmonics that are present are fed back through the twin-T network and therefore suppressed, providing a pure output waveform.

Construction and Setting Up

The oscillator can be constructed as a self-contained unit and if miniature valves are used, it can be very compact. The double-triode recommended is the ECC91 or 6J6, which can be purchased quite cheaply on the surplus market. It is also known in the CV series as the CV858, and has a B7G base. The 6V6 beam tetrode can also be obtained on the surplus market, this of course being a valve with an octal base. As an alternative to the 6V6 a miniature equivalent, the 6BW6, can be used. This is an all-glass valve on a B9A base and the pin connections for this and the ECC91 are given.

The construction of the output coil will depend entirely on the type of head with which it is to be used. It is preferable to wind the coil on a former with an iron dust core: the coil used with the above circuit was wound on a Mullard Ferroxcube core, the whole transformer thus being enclosed in a neat pot construction.

In this case the primary consisted of 400 turns of 36 s.w.g. enamelled copper wire, pile wound, and the secondary of 36 turns of 30 s.w.g. enamelled copper.

So far as the layout of the circuit is concerned no special precautions need be taken. To prevent pick-up in the other circuitry, should the oscillator be built as an integral part of a tape recorder amplifier,

the oscillator should be housed in a screened compartment and the output leads kept well away from the grids of high-gain stages.

The twin-T network should be wired together as neatly as possible, occupying a minimum of space and the input connections kept clear of the output. Any stray capacities across the circuit render the network less effective as a bridge.

The connection for bias for the recording head can either be made to the anode of the power amplifier or to the "free" anode of the ECC91. In either case a resistor of between 50 k. and 150 k. should be connected in series with the head to limit the bias current, which can be adjusted if the series resistor is a potentiometer.

One final note concerns the setting up. When the valve heaters have warmed up, switch on the H.T. (which can be in excess of the 300 volts shown on the diagrams) and, with a pilot light or low wattage torch bulb connected across the secondary of the transformer, slowly rotate the 25 k. positive feedback control until the lamp just begins to glow. This gives an indication of the commencement of oscillation of the circuit in the absence of

more reliable measuring instrument, and for the best waveshape this lower limit should be adhered to.

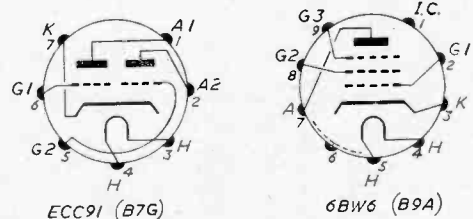

Fig. 7.—Base connections.

Test runs can then be conducted on the tape recorder to set the optimum bias level and adjust the power output for satisfactory erasure.

THE SUPERHET MANUAL

5th Impression

By F. J. CAMM

7/6, by post 7/10

From

GEORGE NEWNES, LTD., Tower House,
Southampton Street, Strand, W.C.2.

Great Britain's Valve



Mail-Order House

Order C.O.D. or remit with order

Postage and packing 9d.

Table listing various vacuum tube types and their specifications, including 6BW7, 6CA, 6C4, 6D6, etc.

Table listing various vacuum tube types and their specifications, including KT76, KT81, KT91, etc.

Table listing various vacuum tube types and their specifications, including U05, U06, U07, etc.

Table listing various vacuum tube types and their specifications, including HBC90, HF93, HK90, etc.



Also ask for Types not listed



And 1000's at Surplus Prices

Great Britain's Valve

Mail-Order House

Two- and Three-valve Superhets

EXPERIMENTAL CIRCUITS USING THE MINIMUM NUMBER OF VALVES WITH MAXIMUM EFFICIENCY

By F. G. Rayer

(Continued from page 550 September issue)

IN valves such as those mentioned, two diodes are generally available. One is used for detection, as shown in Fig. 4, and one for A.V.C., as in Fig. 5.

The degree of A.V.C. action obtained when the diode stage follows the frequency changer will be small. But when an I.F. amplifier is used, the action will be more effective. As A.V.C. is not found in "straight" receivers, and may be unfamiliar, it is not used in the earlier circuits shown. Its purpose is to reduce the gain of the A.V.C. operated stages when the set is tuned to a powerful station, and also to counteract "fading" or variations in signal strength of a station.

For "Gram" Use

When the output stage is the only valve amplifying at audio-frequency, the degree of A.F. amplification is not great. As a result, the volume from a gramophone pick-up would be relatively small. With such circuits, a pick-up with a high output must be used, or volume will be so low that records cannot be played successfully.

These disadvantages may be overcome by using two stages of A.F. amplification. A circuit of this kind is shown in Fig. 6, the number of valves being kept down to three by omitting the I.F. stage. The selectivity and sensitivity of such a circuit is less than with the F.C./I.F./Output type of circuit, but much more A.F. amplification is available. As a result, it gives quite good results on radio, with plenty of volume on gram, with an average pick-up. It lends itself very readily to the subsequent addition of an

I.F. stage. A valve such as the 6K7 could be used, with a S.G. dropper resistor of 50 K., a .1 μ F condenser being wired from S.G. to H.T. negative. No other components would be required, except the valveholder and I.F. transformer. A.V.C. might afterwards be used, as explained.

Power Supplies

Fig. 4 shows the method of arranging power supplies in an A.C./D.C. type receiver. With such receivers, all valves must be of the same heater current rating, with heaters wired in series. A mains dropper is added in series with the heater chain to enable the valves to be operated from the mains.

If the valves are all of the same voltage rating, as in Fig. 6, all the heaters are wired in parallel, and operated from a transformer secondary of suitable voltage—6.3 v. in this instance. This is shown in Fig. 7(a), which also shows how a metal rectifier can be used to obtain H.T. With a 250 v. transformer secondary, the rectifier should be rated at 250 v. 60 mA. It is feasible to take the rectifier to one mains lead, via a 200 ohm resistor, and to connect the other mains lead to point "Y" or H.T. negative. But the use of a transformer enables the receiver to be isolated from the mains, and it is recommended with all A.C. equipment, especially when a pick-up is employed. If a transformer with a 250/0/250 v. secondary is to hand, it can be used by wiring "0" to H.T. negative, and one 250 v. tag to rectifier negative. (In no circumstance should both 250 v. tags be connected together for the rectifier connection.)

Full-wave rectification with a valve is shown at (b)

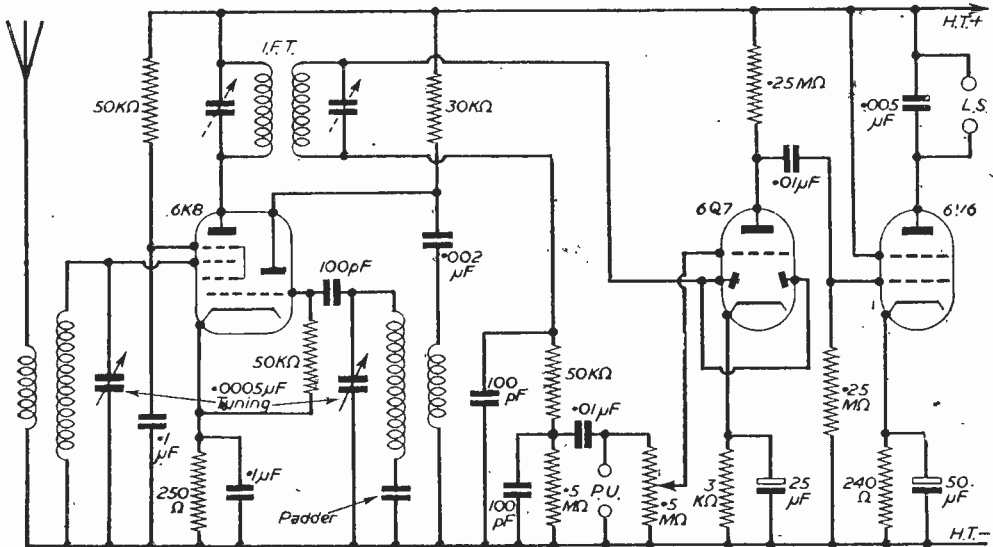

Fig. 6.—A three-valve circuit with two A.F. stages.

in Fig. 7. A suitable valve is the 5Z4G, which requires a 5 v. 2 amp. heater winding, in addition to the heater winding for the other valves. For a given degree of smoothing, hum will be at a lower level with such a rectifier, than if a metal rectifier is employed. With A.C./D.C. type circuits, a valve rectifier can be used, its heater being wired between output valve and dropper. The rectifier cathode is taken to the smoothing choke (point "X") and the anode, via a 100 ohm resistor, to one mains lead. The other mains lead is taken to point "Y."

Reflexing

The circuits shown have not employed any reflex arrangement, because of the complication involved. There is also some chance of instability with reflex circuits, and a good layout is required. If this is kept in mind, however, some additional volume may be obtained with a given number of valves, and a typical reflex circuit is shown in Fig. 8. The frequency-changer circuit would be completed exactly as with any of the circuits so far described.

In Fig. 8, the second valve does duty as both I.F. and A.F. amplifier. The I.F. signal passes to the diode, where it is changed to an audio signal. This returns to the valve grid through the first I.F. transformer secondary, and passes to the speaker through the second transformer primary, as these windings present only a very low impedance to A.F. signals. This circuit may be made up in battery or mains type. If maximum volume from local stations is required, then an output valve is used in the second position. Results are not quite as good as would be obtained from three valves, primarily due to the losses in the filter network which has to be used between diode and valve.

Finally, beginners may have noted that no *one valve* superhet has been shown. This can, however, be made up by using the circuit shown in Fig. 1, the output stage and associated parts being omitted.

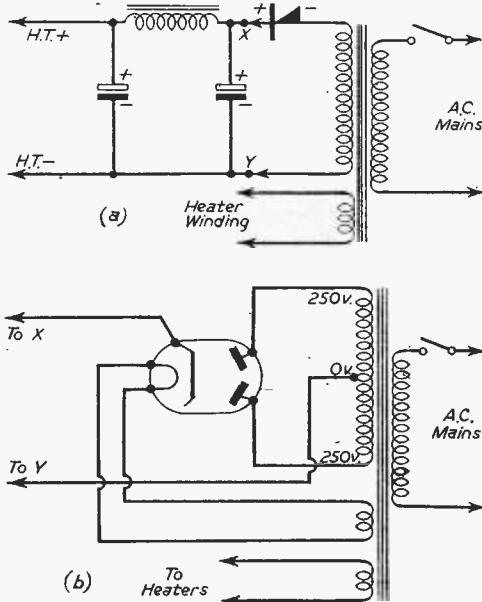

Fig. 7.—Power supply circuits.

Phones should be wired from the diode to H.T. negative, and good local-station results are obtainable.

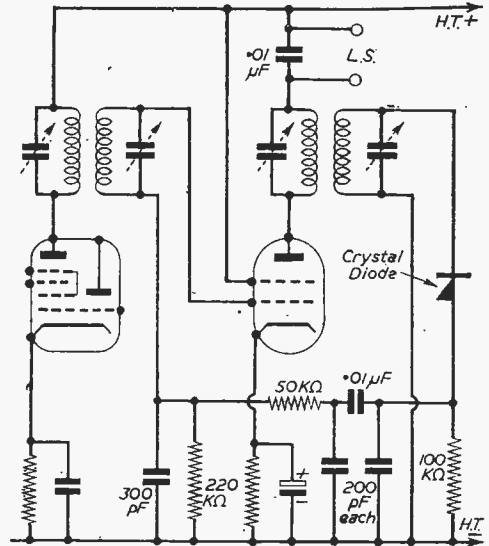

Fig. 8.—A two-valve reflex circuit.

The transformer, 500 ohm bias resistor, and 25 μF bias condenser are all omitted, H.T. negative being wired to L.T. negative.

V.H.F. Communications

AN order has been placed with Marconi's Wireless Telegraph Co., Ltd., by the Gold Coast Posts and Telecommunications Department.

The new contract calls for the supply and installation of a twin-path, 24-channel (per path), V.H.F. radio communications service from Kumasi to Takoradi, via Mpraeso, Koforidua, Mampong (Akwapim), Accra, Winneba and Cape Coast. The terminal at Takoradi will be accommodated in a new telephone exchange which is currently under construction by the Gold Coast P. and T. Authorities.

The equipment to be supplied includes 20 Marconi multi-channel Terminal Units type HM105, and four Marconi multi-channel Repeater Units type HM155, together with power supplies, ancillary equipment and spares. A number of channels of each radio path are to be extracted at three points, namely at Koforidua, Winneba and Cape Coast, so as to enable local telephone lines in those areas to link with the trunk route. At all repeater stations, the equipment will work entirely unattended. The aerials to be used will be mounted on steel towers, which, in some instances, are to be 250ft. in height.

This project will link with a twin path, 12-Channel (per path) service between Tamale (in the north), Palbusi, Salaga, Prang, Abuo, Ejura, Mampong and Kumasi, the supply and installation of which is already being carried out by Marconi's.

The complete scheme will thus provide a valuable aid to the Gold Coast's expanding export market, not only by giving facilities for internal communication, but also by bringing the hinterland into direct radio contact with the capital cities of the world, via the Cable and Wireless stations on the coast.

MONTROSE MULTIMETER MODEL 44A



7 RANGES—Voltage : 0-6-30-150-300 volts
Current : 0-30mA-300mA-3 Amperes
A.C. and D.C.

Circuit Tests—Self-contained, easily accessible
1½ v. cell provides quick continuity testing.

Reliability—Robustly built moving iron
movement, designed to stand up to
everyday use.

Convenient pocket size—Weight 8 oz.

Price £3.30. Prompt Delivery.

NEW TAYLOR Valve Tester.

Measures mutual conductance of over 4,000 up-to-date valves.

Model 45c

PRICE £27.10.0 PROMPT DELIVERY.

HIRE PURCHASE TERMS

*3 months £4. 2. 6 deposit. 3 monthly payments of £8.15.4
10 " £4. 2. 8 " 10 " " £2.12.7
15 " £4. 2. 8 " 15 " " £1.17.0

* Hire Purchase interest refunded if paid within 3 months.

TAYLOR Multirange Meter (1,000 o.p.v.).
A.C. and D.C. Sin. scale. Robust, overload protection.

Model 71A

PRICE £12.10.0. PROMPT DELIVERY.

HIRE PURCHASE TERMS

*3 months £1.17. 6 deposit. 3 monthly payments of £3.19.8
10 " £1. 5. 8 " 10 " " £1. 5. 1
15 " £1. 5. 8 " 15 " " £1. 7. 9

* Hire Purchase interest refunded if paid within 3 months.

TAYLOR T.V. Sweep Generator.

For T.V. and F.M. alignment

Model 92A

PRICE £30.0.0 PROMPT DELIVERY.

HIRE PURCHASE TERMS

*3 months £4.10. 0 deposit. 3 monthly payments of £9.11.3
10 " £3. 0. 5 " 10 " " £3. 0. 4
15 " £3. 0. 5 " 15 " " £2. 2. 8

* Hire Purchase interest refunded if paid within 3 months.

TAYLOR Multirange Meter (20,000 o.p.v.).
Ideal for Radio and T.V. work.

Model 77A

PRICE £15.0.0. PROMPT DELIVERY.

HIRE PURCHASE TERMS

*3 months £2. 5. 0 deposit. 3 monthly payments of £4.15.7
10 " £1.10. 1 " 10 " " £1.10.2
15 " £1.10. 1 " 15 " " £1. 1. 4

* Hire Purchase interest refunded if paid within 3 months.

TAYLOR Signal Generator.

Frequency range 100 kc/s-240 mc/s. Accuracy 1%.

Model 67A

PRICE £22.0.0. PROMPT DELIVERY.

HIRE PURCHASE TERMS

*3 months £3. 6. 0 deposit. 3 monthly payments of £7. 0. 3
10 " £2. 4. 3 " 10 " " £2. 4. 3
15 " £2. 4. 3 " 15 " " £1.11.4

* Hire Purchase interest refunded if paid within 3 months.

TAYLOR Multirange Meter (20,000 o.p.v.).
Most versatile for Radio and T.V. and Electrical work.

Model 88A

PRICE £22.0.0. PROMPT DELIVERY.

HIRE PURCHASE TERMS

*3 months £3. 6. 0 deposit. 3 monthly payments of £7. 0. 3
10 " £2. 4. 3 " 10 " " £2. 4. 3
15 " £2. 4. 3 " 15 " " £1.11.4

* Hire Purchase interest refunded if paid within 3 months.



• ALL Taylor instruments are readily available on Hire Purchase Terms. Write for full details and Catalogue.

ELECTRICAL INSTRUMENTS LTD.

MONTROSE AVENUE, SLOUGH, BUCKS. Tel : Slough 21381. Cables : Taylins, Slough.

THE WBI2 HIGH FIDELITY AMPLIFIER

Already acclaimed by Percy Wilson, F. J. Camm, John Gilbert and many other leading authorities.

Employing the most recently developed valves, it has a low noise input circuit, feeding the double triode phase splitter, and a push-pull output stage, ultra-linear connected, using a specially designed Whiteley Output Transformer. 25 db negative feed back is applied over the main amplifier. Switched pick-up matching is incorporated in an extremely flexible, compact and easily mounted pre-amplifier tone control unit, incorporating a selector switch for tape, radio, 78, ffr, LP and "direct", and sockets for tape input and replay. Both units are attractively styled and finished in hammered gold.

This equipment, when used in conjunction with Stentorian speakers, provides most outstanding reproduction.

Price £25 complete

Detailed specification on request.

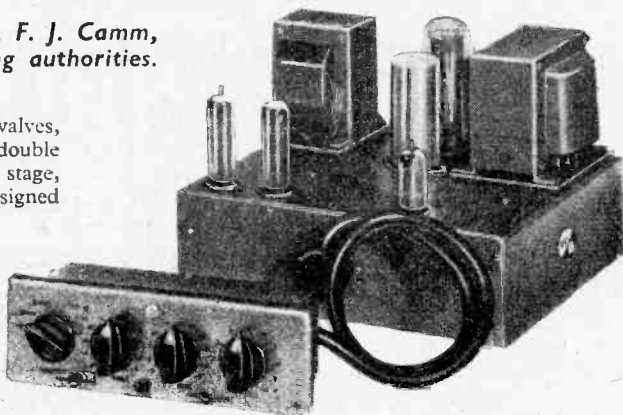

another Whiteley winner!

See it on Stand 25, at the Radio Show. Alternatively this amplifier may be heard, together with Stentorian Hi Fi Units, any Saturday between 9 a.m. and 12 noon at our London Office, 109 Kingsway, W.C.2.



WHITELEY ELECTRICAL RADIO CO. LTD · MANSFIELD · NOTTS

RODING LABORATORIES



—how to avoid this?

GET THE
RODING
"HOME



—here's
the
answer!

CONSTRUCTOR'S HANDBOOK "

The latest issue is packed with technical data, set building and servicing hints, facts and formulae, resistance colour code, soldering hints, etc. In the main, however, the book is devoted to descriptions, full parts lists and circuits of 22 time-tested outfits as listed below. The price? ONLY 2/6 (plus 3d. post). SEND TO-DAY—DON'T DELAY!

- * 3-valve superhet Feeder Unit
- * 4-valve Feeder unit (R.F. stage), with hi-fi and gram. switching
- * Amplifier Power pack for both above
- * 5-valve superhet A.C. with gram.
- * 5-valve superhet A.C. D.C.
- * 6-valve superhet A.C. (R.F. stage)
- * 6-valve superhet A.C. D.C. (")
- * Simple Continuity Tester
- * Magic Eye unit
- * Modified 40 Feeder Unit Circuit
- * "P.W." Coronet AC4 Superhet
- * "P.W." Coronet A.C. D.C. 4 Superhet
- * "P.W." Coronet Battery 1 Superhet
- * Tape Recorder
- * 3in. Oscilloscope
- * 8-valve Communications Receiver
- * Signal Tracer
- * 5-watt quality amplifier
- * 10-watt high-fidelity push-pull amplifier
- * Signal Generator
- * Crystal Set
- * Local station high-fidelity T.R.F. feeder unit

Our famous "Easy-as-A.B.C." FULL SIZE Construction Sheets are available for most of the above enabling even the beginner to get first-class results first time! We can supply ALL parts including pre-aligned Coil Packs and I.F.T.'s

NEVER BEFORE HAS THERE BEEN A BOOK SO VALUABLE TO NOVICE AND EXPERT ALIKE!

(Dept. TC2), Bournemouth Airport, Christchurch, Hants.

BUILD THIS FOR 49/6



Build this exceptionally sensitive twin-tube radio. Uses unique assembly system and can be built by anyone without any radio knowledge whatever in 45 minutes. Handsome black-crackle steel case with specially made black and gold dial with stations printed. Size of radio only 6 1/2 in. x 3 in. x 3 in. Covers all Medium and Long waves—uses one only aldry battery which costs 7s. 9d. and lasts many months, as H.T. consumption is only 1 to 1.5 mA. Ideal for Bedroom, Garden, Holidays, etc. Many un-solicited testimonials. Mr. Norton, of Oxford, writes: "Yesterday evening on the Medium waveband, I counted 32 separate stations; I am very pleased with the set, which is well worth the money. Cost of Complete Kit 49s. 6d. (including all plans, post, etc.). Parts sold separately. Price List, Plans, etc., 2/-. Note: We stock complete range of components and valves, orders despatched by return. Overseas orders welcomed—Regret No C.O.D. abroad.

BRIGHTON RADIO CO. (P.W.C.)
69, Preston Street, Brighton, 1.

Using TEST INSTRUMENTS



Part 10 of a Series of Articles
Dealing with the Practical Application
of Standard Test Equipment



(Continued from page 524 September issue)

The Oscilloscope (33)

PARTLY with the aid of an oscilloscope, bandwidth measurements and response curve checking can be performed in a somewhat less tedious and more interesting manner. An additional piece of test equipment known as a wobulator or F.M. oscillator is also required for tests of this kind, and when an oscilloscope and a wobulator are properly connected to a receiver the actual response curve is portrayed on the screen of the oscilloscope, thereby making it a relatively simple matter to adjust the tuned circuits until the desired response shape and bandwidth are obtained.

Before we consider the wobulator in detail, however, it will be best to find out about some of the very many varied applications of the oscilloscope when it is employed by itself.

We all know, of course, that the basis of an oscilloscope—or 'scope for short—is an electrostatically deflected and focused cathode-ray tube (C.R.T.). For a large number of practical applications the electron beam is made linearly to traverse the screen of the C.R.T. in a horizontal direction (from left to right), while the voltage waveform under examination is arranged to deflect the beam vertically.

A timebase within the 'scope provides the function of horizontal deflection by means of a sawtooth

waveform, and facilities are provided for varying the timebase repetition frequency, and thus the speed of travel of the spot horizontally across the C.R.T. screen. For this purpose, two external controls are frequently used, one providing a "rough" adjustment which alters the timebase (t.b.) frequency in multiples of 10, while the other—a "fine" adjustment—enables the frequency to be adjusted within the limits set by the "rough" adjustment.

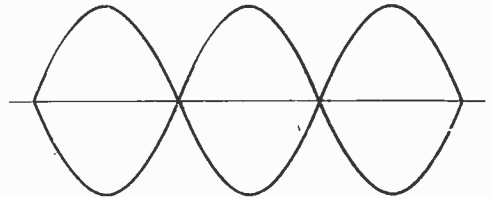

Fig. 40.—The type of pattern which results when the frequency relationship of the "X" and "Y" voltages is between two exact multiples.

The range of t.b. adjustment varies between instruments: the less expensive kind probably have a maximum top speed in the region of 10,000 c.p.s., while the more elaborate laboratory instrument goes up to many times this figure. It must, of course, be remembered that, apart from having an extended t.b. range, it is essential for the electron beam to be deflected from left to right at a constant speed, after which returning to its starting point in the shortest possible time. At high t.b. speeds these often desirable features are not cheaply achieved.

The deflecting plates within the C.R.T. which are subjected to the t.b. voltage are generally referred to as the "X" plates. Nearly all commercial 'scopes have an external means of connection to the "X" plates; and this can be very useful for certain applications as we shall see later in this series. The other set of plates to which the examination voltage is applied are known as the "Y" plates. One of these is sometimes connected to a common earth terminal and the other one is brought out to a terminal on the front of the instrument.

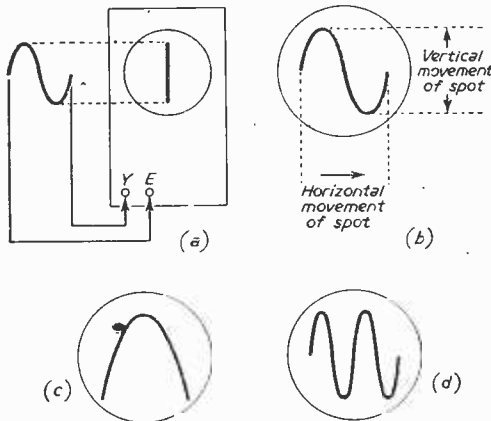

Fig. 39.—(a) The straight vertical line traced on the screen will have a total length corresponding to a value equal to twice the peak voltage of the applied waveform. (b) Showing how a sine-wave is traced on the C.R.T. when the t.b. frequency equals the signal frequency (c) when it is twice the signal frequency, and (d) when it is half the signal frequency.

The Trace (34)

At this point it will be instructive to consider the formation of a simple trace on the screen of the C.R.T. Let us suppose, for example, that a sample of the 50 c.p.s. mains voltage is applied to the "Y" plates and that the t.b. is switched off so that the beam is not being deflected horizontally. The spot on the screen will then follow the rise and fall in voltage

from a maximum in the positive direction to a maximum in the negative direction, as shown at Fig. 39(a). A straight vertical line will thus be traced, the total length of which corresponds to a value equal to twice the *peak* voltage of the applied waveform.

Now, suppose a trace is obtained with a length corresponding to 20 volts, then the peak voltage of the applied A.C. will be half of this, or 10 volts, and the R.M.S. value of the applied A.C. will be 0.707 times 10, or 7.07 volts. Clearly, then, provided we know the deflection sensitivity of the "Y" plates, a simple application of the 'scope is that of measuring A.C. voltages.

The sensitivity of the "Y" plates is generally given, or if not it could easily be calibrated against an accurate A.C. voltmeter. Where it is given, however, it is generally in terms of mm. per volt; thus, with a tube having a sensitivity of, say, 0.2 mm/V. the spot will move 2 mm. per volt applied to the "Y" plates.

When an oscilloscope is used in this way it virtually has the application of a valve voltmeter owing to its extremely high input impedance; moreover, the frequency of the applied voltage does not affect the sensitivity of the tube, but slight errors may occur at very high frequencies as the result of the input capacitance of the tube and associated wiring.

Some instruments feature a calibrated graticule so that the voltage of the applied signal can quickly be computed.

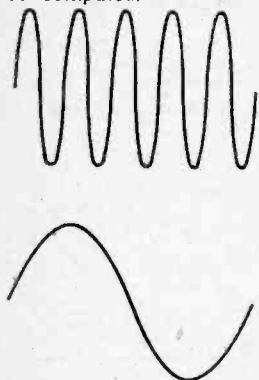

Now let us suppose that with a sample of the

Fig. 41.—Frequency comparison is eased by using a double-beam 'scope, here the top trace is five times the frequency of the bottom standard trace.

50 c.p.s. mains voltage applied to the "Y" plates

we switch on the t.b. so that the spot on the screen is being moved simultaneously across the screen in a horizontal direction. A waveform of similar nature to that shown in Fig. 39(b) will be traced on the screen. It should be noted, however, that in this case the time taken for the spot to travel from left to right across the screen is equal to the time of one complete sine-wave. Clearly, then, the repetition frequency of the t.b. must be equal to the frequency of the mains voltage.

It follows, therefore, that doubling the t.b. frequency will result in one-half of the waveform only being traced on the screen—Fig. 39(c). Halving the t.b. frequency will produce two complete waveforms—Fig. 39(d)—and so on. The same relationship holds good if the sample voltage frequency is halved or doubled, divided or multiplied.

Since the precise number of waveforms or parts of waveforms appearing depends on the relationship between the applied voltage frequency and the t.b. repetition frequency even a simple 'scope can be used as a frequency comparing device.

At Fig. 40 is shown the type of pattern which results when the frequency relationship is between two exact multiples, but as a general rule it is desirable to avoid using this form of pattern for the comparison of frequencies as it is not always possible to say what the frequency ratio is, particularly with the higher multiples.

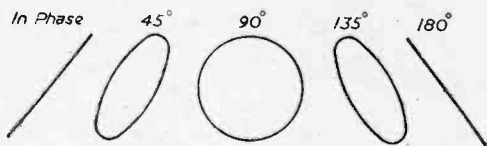

Fig. 42.—A sequence of patterns which are produced by two voltages of equal amplitude and frequency, but differing in phase angle from in phase to 180 degrees out of phase.

Some of the more expensive laboratory type 'scopes are built round a double-beam C.R.T., so that for frequency measurements a waveform of standard frequency can be displayed on the screen at the same time as the waveform being measured. This considerably eases frequency measurements, as may be seen at Fig. 41, where the bottom beam forms one complete wave of a standard frequency and the beam at the top of the tube forms five waves, thereby clearly indicating a frequency ratio of 5 to 1.

Double-beam 'scopes have hosts of other applications, of course, but they are used mainly in the laboratory as opposed to the normal service workshop. Nevertheless, there are occasions when a double-beam instrument, capable of presenting two different traces simultaneously, can be extremely useful, even in the service workshop, and at this stage we would mention that an ordinary 'scope can be arranged to display a pair of separately controllable traces by means of an electronic switch; but more about this later.

Other Methods of Frequency Comparison (35)

If two voltages of the same frequency are applied to the "X" and "Y" plates, the result is either a straight diagonal line or an ellipse. The straight line is produced when the two frequencies are exactly in phase, and provided they are both sine-waves. Should either of the waves not obey the sine law, however, the line will be irregular in appearance.

The ellipse is produced when a phase difference occurs between the "X" and "Y" voltages, but the dimensions of the ellipse will depend on the phase angle and on the relative amplitudes of the voltages. When the amplitudes are the same and there is a 90 deg. phase angle a perfect circle will be displayed. As the phase angle is increased, the ellipse decreases in width until it again collapses to a diagonal line, when the two frequencies are 180 deg. out of phase, but of an opposite slope to the original when the two frequencies were exactly in phase. The same effect occurs, but in an opposite sense, as the phase angle is increased from zero, when the two voltages are perfectly in step to 90 deg., when a circle results. The sequence may be seen from the patterns at Fig. 42.

So far, of course, we have been considering waves of identical frequency and differing only in phase angle. Therefore, it will now be realised that if

(Continued on page 637)

C.R.T. ISOLATION TRANSFORMERS

Type A. Low leakage windings. Ratio 1:25 giving a 25% boost on Secondary. 2 v., 10/6; 4 v., 10/6; 6.3 v., 10/6; 10.8 v., 10/6; 13.3 v., 10/6.
 Ditto with mains primaries. 12.6 each.
Type B. Mains Input 220/240 volts. Multi Output 2, 4, 6.3, 7.3, 10 and 13 volts. Input has two taps which increase output volts by 25% and 50% respectively. This transformer is suitable for most Cathode Ray Tubes. With Tag Panel, 21/- each.
Type C. Low capacity wound transformer for use with 2 volt Tubes with falling emission. Input 220/240 volts. Output 2-21-21-2-3 volts at 2 amps. With Tag Panel, 17/6 each. All Isolation Transformers are individually boxed, labeled and clearly marked with relevant data.

BALANCED TWIN FEEDER. jd. 6d. 80 or 300 ohms. DITTO SCREENED per jd. 9d. 80 ohms.
50 OHM COAXIAL CABLE 8d. per yd. 2in. dia. TRIMMERS, Ceramic, 30, 50, 70 pf. 9d. 100 pf. 150 pf. 1/3; 250 pf. 1/8; 500 pf. 750 pf. 1/9. RESISTORS. All values. 10 ohms to 10 meg. 1 w., 4d.; 1/2 w., 6d.; 1/4 w., 8d. 2 1/2 w., 1/-. HIGH STABILITY. 1/2 w. 1/-, 2/-. Preferred values 100 ohms to 10 meg.

5 watt WIRE-WOUND RESISTORS 1/3
 10 watt 25 ohms-10,000 ohms 1/6
 15 watt 2/-
 15,000 ohms-50,000 ohms. 5 w., 1/9; 10 w., 2/3
WIRE-WOUND POTS, 3 WATT. FAMOUS MAKE Pre-set Min. T.V. Type Standard. POTS, 24in. All values 25 volts to 30. Spindle. All Values. K., 3/- each. 50 K., 4/-, 100 ohms to 30 K., 5/6; 100 K., 6/6.
W/W EXT. SPEAKER 50 K. to 2 meg., 3/-.
CONTROL 100, 3/-
O/P TRANSFORMERS. Heavy Duty 50 mA., 4.6/- ditto, tapped primary, 4/9. Multistage, push pull 6/6. Tapped small pentode, 3/9. Miniature 35d. each, 3/9.
L.F. CHOKES 15/10 H. 60, 65 mA., 5/-; 25/20 H. 300/120 mA., 11/6; 20/15 H. 120/150 mA., 12/6.
MAINS TRANS. 350-0-350, 80 mA., 6/3 v., tapped 4 v., 4.5 v., tapped 4 v., 2a., ditto 250-0-250, 21/-.
MIDGET 250-0-250 v. 30 mA., 6.3 v., 2 a., 12/6.
HIGHER TRANS. Tapped prim., 200/250 v. 6.3 v. 11 amp., 7/6; tapped sec. 2, 4, 6.3 v., 11 amp., 8/6; 6.3 v. 3 amp., 10/6.

CRYSTAL MIKE INSERT. Famous make. precision engineered. Size only 11 x 3/16in. Bargain Price, 6/6. No transformer required.

COPPER PLATED AERIAL RODS. 1/2 x 12in. push fitting, 2/6 Joz., 1/2 p. 3d. Aeriline Earth Rods, 4/-.
ALADIN FORNERS and cone. 1in. dia., 10d. only.
TYANA.—Midget Soldering Iron. 200/220 v. or 220/250 v., 14/11. Triple Three mod. with detachable bench stand, 10/6. Solon Midget Iron, 22/-.
MIKE TRANSF. Ratio 50:1, 3/9 ea., new.
MAINS DROPPERS. 3 x 1 1/2in. Ad. 5/1d., 3 amp. 750 ohms, 4/3; 2 amp., 1,000 ohms, 4/3.
LINE CORD. 3 amp., 60 ohms per foot, 2 amp., 100 ohms per foot, 2 way, 6d. per foot, 3 way, 7d. per foot.
LOUDSPEAKERS P.M. 3 OHM. 5in., 16/6. 6 1/2in., 17/6. Goodmans Elliptical 7 x 4, 18/6. 8in., 19/6. 10in., 25/-. 6 1/2in. Goodmans with trans., 21/-.
 Famous make 10in. 10 watt heavy duty speakers, 3 ohm, Aluminium voice coil, 39/6. 8in. Mains energised 2.5 K. or 2 K. ohm field, with tapped output trans., 24/6; less trans., 21in., 12in. Lightweight Plessey, 30/-.
CRYSTAL DIODES. G.E.C., 3.8. Circuit Book, 1/-.
S. G. BROWN'S. 4,000 ohms, 15/6 per.
COPPER ENAMEL WIRE. 1lb. to 16 to 20 s.w.g., 2/-; 22 to 28 s.w.g., 2/6; 30 to 40 s.w.g., 3/6.
SWITCH CLEANER. Finol, spirit, 3/9.
TWIN GANG TUNING CONDENSER. 2000 p.f. mid. midget with trimmers, 8/8; 375 p.f. mid. less trimmers, 6/6; .0005 Standard size with trimmers and feet, 9/-; less trimmers, 8/-; ditto, sealed, 2/6.
SPEAKER FRET. Woven Plastic 1/4x4in. Walnut tone, 12in. wide, 2/6 per foot. Expanded metal, Gold or Silver, 9 1/2 x 12in., 2/- each.

7/6 VALVE SALE 7/6
 New boxed. All guaranteed.
 1R5, 1R5, 1T4, 1R1, 3R4, 3V1, 6AN6, 6F12, 6BE6, 6BW6, 6CK7, 6K8, 6SA7, 6SL7, 6V6, 6X4, 6X5, 7S7, 7Y3, 12AX7, 807, 8E31, 8E32, 8E33, 8E34, 8E35, 8E36, 8E37, 8E38, 8E39, 8E40, 8E41, 8E42, 8E43, 8E44, 8E45, 8E46, 8E47, 8E48, 8E49, 8E50, 8E51, 8E52, 8E53, 8E54, 8E55, 8E56, 8E57, 8E58, 8E59, 8E60, 8E61, 8E62, 8E63, 8E64, 8E65, 8E66, 8E67, 8E68, 8E69, 8E70, 8E71, 8E72, 8E73, 8E74, 8E75, 8E76, 8E77, 8E78, 8E79, 8E80, 8E81, 8E82, 8E83, 8E84, 8E85, 8E86, 8E87, 8E88, 8E89, 8E90, 8E91, 8E92, 8E93, 8E94, 8E95, 8E96, 8E97, 8E98, 8E99, 900, 901, 902, 903, 904, 905, 906, 907, 908, 909, 910, 911, 912, 913, 914, 915, 916, 917, 918, 919, 920, 921, 922, 923, 924, 925, 926, 927, 928, 929, 930, 931, 932, 933, 934, 935, 936, 937, 938, 939, 940, 941, 942, 943, 944, 945, 946, 947, 948, 949, 950, 951, 952, 953, 954, 955, 956, 957, 958, 959, 960, 961, 962, 963, 964, 965, 966, 967, 968, 969, 970, 971, 972, 973, 974, 975, 976, 977, 978, 979, 980, 981, 982, 983, 984, 985, 986, 987, 988, 989, 990, 991, 992, 993, 994, 995, 996, 997, 998, 999, 1000.

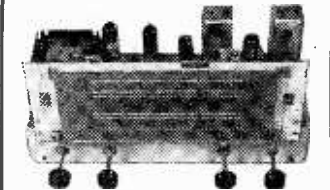

ALL WAVE RADIOGRAM CHASSIS

THREE WAVEBANDS FIVE VALVES
 A.C. 200/250 v. 4-way Switch; Short-Mid-Long-gram. A.V.C. and Negative feedback. 4.2 watts. Chassis 13 1/2 x 2 1/2in. Glass Dial 10 x 4 1/2in., horizontal or vertical available. 2 Pilot Lamps, Four Knobs, Walnut or Ivory, aligned and calibrated. Chassis isolated from mains. PRICE £10/15/-. Without 10in. Speaker, £9/15/-. Carr. & Ins., 4/6.
 12 month Guarantee, with 10in. P.M. Speaker. A.C. 200/250 v. 4-way Switch; Short-Mid-Long-gram. A.V.C. and Negative feedback. 4.2 watts. Chassis 13 1/2 x 2 1/2in. Glass Dial 10 x 4 1/2in., horizontal or vertical available. 2 Pilot Lamps, Four Knobs, Walnut or Ivory, aligned and calibrated. Chassis isolated from mains. PRICE £10/15/-. Without 10in. Speaker, £9/15/-. Carr. & Ins., 4/6.

RECOMMENDED FOR ABOVE CHASSIS



Price Carriage Paid **£9.19.6**

Brand new Plessey 3-speed Autograph Mixer Unit for 7, 10 and 12in. Records. Twin Hi-Fi Xtal Head with Duopoint sapphire stylus. Plays 4,000 records. Sprung mounting. Baseboard required 15 1/2 x 12 1/2in. Height 5 1/2in. Depth 2in. Super Quality.

FAMOUS MAKE. 3-speed Single Record unit with Acos 37 Turnover Head, each Sapphire Stylus plays 2,000 records. Starting Switch Automatically places Pick-up on records, 7in., 10in. or 12in. Auto Stop. Baseplate 12 x 8 1/2in. Height 2 1/2in. Depth 1 1/2in. Price £7/15/6, post free.

B.S.R. MONARCH 3-SPEED MIXER CHANGER ACOS GP 37 XTAL HEADS. Baseboard 14 x 12in. Height 5 1/2in. Brand new in Makers' Boxes. £9/18/6, post free.



£4/19.6. CONVERT YOUR RADIO. Playing £4.19.6. 22-7in. Walnut finish, drawer front with 78 r.p.m. motor, turntable and pick-up. Press lever start places High Impedance Magnetic pick-up on records 10in. or 12in. Auto Stop. Brand new in original makers' boxes. £4/19.6, carr. free.

SUPERB COIL PACK 27/6. Miniature size 2 1/2 x 2 1/2in. High Q. dust cored coils. SHORT, MID., LONG, GRAM switching. Only 27/6 each with connection diagram and circuit.

BAND 3 T.V. CONVERTER KIT
 Ready wound coils, B.V.A. valves, all components, punched chassis, circuit diagram, wiring plans. COMPLETE KIT for mains operation 200-250 v. A.C. £23/10/0.

AS ABOVE LESS POWER PACK. Requires 200 v. 20 mA. H.T. 6.3 v. 1 a. L.T. £25/-.
PUNCHED CHASSIS and WOUND COILS, component list, circuit diagram, wiring plans, only 13/6.

Volume Controls 80 ohm Coaxial CABLE
 Long spindles. Guaranteed. Semi-fur spaced Poly-thene insulated. 1in. dia. 10,000 ohms to 2 Meg. No Sw. N.P.S.W. D.P. 3w. Losses cut 50% 9d. yd. EXT. 3/-. 4/- 4/9
COAX PLUGS 1/- **DOUBLE SOCKET 1/6**
SOCKETS 1/- **OUTLET BOXES 3/6**

TV PRE-AMP. Channel 1. Easily modified for other Channels or Converter use. Midget Chassis 4 1/2 x 4 1/2in. Complete with EF42 or 6F13 valve, coaxial lead, Belling plug and Octal plug. Ready for use. Brand new Mits. Surplus. Listed £3/15/-. Special Clearance Price 21/-, Buy Yours NOW.

PYE Aerial Plug and Socket. 1/8 pr.
CONDENSERS. New stock. .001 mfd. 7 kV. T.C.C., 5/6. Ditto. 12.5 kV., 9/6; 2 pf. to 500 pf. Micres, 6d.; Tubular 500 v. .001 to .01 mfd. 10d.; .05 1/2, 1/-; .1 2/6; .5, 1/8; 1/350 v. 9d.; 1/600 v. 1/3; 1/1,200 v., 3/8.

CERAMIC CONDS. 500 v. 3 pf. to .01 mfd., 1/-.
SILVER MICA CONDENSERS.—10% 5 pf. to 500 pf. 1/-; 600 pf. to 3,000 pf., 1/3. DITTO 1/5. 1.5 pf. to 500 pf. 1/9; 515 pf. to 1,000 pf., 2/-.

TUBULAR CAN TYPES CAN TYPES
 2/450 v. 2/3 16,500 v. 4/- 4+16,450 v. 5/6
 5/450 v. 2/3 5,000/12 v. 3/- 32+32,350 v. 4/8
 16,500 v. 4/- SCREW BASE 32+32/450 v. 6/6
 25/25 v. 1/9 TYPE 512 60+100/350 v. 11/6
 50/50 v. 2/- 8,500 v. 4/- 1,000+1,000/6v. 6/6
 100/25 v. 2/- 10,500 v. 4/- 15,000 v. 4/6

**RECTIFIER RECTIFIERS. E.H.T. TYPE FLY-
 BACK VOLTAGES.** K/25 2 kV. 4/3; K/30 3 kV. 6/-; K/34 3.5 kV. 6/6; K/30 4 kV. 7/3; K/3/100 8 kV. 12/6; K/3/100 14 kV. 18/-. MAINS TYPE. RM1, 125 v., 60 mA., 4/-; RM2, 100 mA., 4/9; RM3, 100 mA., 5/9; RM4 250 v., 275 mA., 16/-.
T.V. AERIALS. Indoor loft type Inv. T., 13/6. Band 3 adaptors, 7/6 pr.

2/6 SPECIAL CLEARANCE 2/6
 BRAND NEW SUB MINIATURE VALVES

Ex Deaf Aid Apparatus
 R.P. Pentodes 1.25 v. Fil. L.P. Pentodes 1.25 v. Fil.
 0.825 v. Fil. 1.25 v. Fil.
 XFW 10 HIVAC XFY11
 XFW 20 HIVAC XFY12
 DF66 MULLARD DL36
 DF70 MULLARD DL72
 505AX RAYTHEON 503AX
 507AX 607AX

COILS. Wearite. "P" type, 2/6 each. Osamor Midget "Q" type adj. dist. core, 3/6 each. All ranges.

ALUMINIUM CHASSIS. 18 s.w.g. Plain, anodized, folded 4 sides and riveted corners lattice fixing holes. Strong and soundly constructed with 2 1/2in. sides. 7 x 4in., 4/6; 11 x 7in., 6/9; 13 x 9in., 8/6; 14 x 11in., 10/6; 18 x 18 x 3in., 18/6.

FULL WAVE BRIDGE SELENIUM RECTIFIERS. 2.5 or 12 v. 11 amp., 8/9; 2 a., 11/3; 4 a., 17/6.
CHARGER TRANSFORMERS. Tapped input 200/250 v. for charging at 2.5 or 12 v. 11 amp., 13/6; 4 amp., 21/-.
ACID HYDROMETER. New Ex Govt. Unbreakable. Packed in metal case 7 x 1 1/2 in. dia., 4/6.
H.F. MIDGET CHOKES. 14 H.F., 2/6 each.

RECORDING TAPE
 1,200 ft. on standard fitting 7" Plastic reels. Brand new boxed 17/6.

F.M. TUNER COIL KIT. 27/6. H.F. coil, Aerial Coil, Oscillator Coil, two I.F. Transformers 10.7 Mc. s. Detector transformer and heater choke. With circuit and component list for popular F.M. Tuner using four 6AM6 valves and standard components.

We have no connection with any other firm. Please address all correspondence correctly as below.
RADIO COMPONENT SPECIALISTS 307 WHITEHORSE RD., WEST CROYDON
 OPEN ALL DAY—(Wed. 1 p.m.) 10 page list S.A.E.
 Tel. THO 1665, after 6 p.m. 4198. Buses 133 or 68 pass door. 48-hour postal Service. P. & P., 6d. £1 orders post free. C.O.D. Service 1/6

SUPERIOR RADIO SUPPLIES

SUPERIOR BUREAU

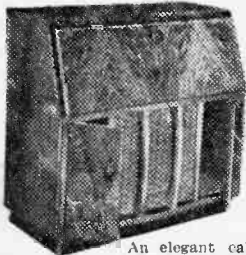

An elegant cabinet in richly figured walnut veneer. Internal panels in polished sycamore. A drop front lid covers a sloping, uncut control panel (14in. long x 10 1/2in. high) alongside which is an uncut baseboard (17 1/2in. long x 13 1/2in. back to front). The inside of the drop front lid is panelled in beige leatherette. In the lower part of the cabinet are two large storage cupboards (13 1/2in. high, 7 1/2in. wide, 16 1/2in. deep). The lid and cupboard handles are in chased Florentine bronze. Overall dimensions (38in. high, 34in. long, 16 1/2in. deep). Price £17.0.0. plus 15/- carr. Send for Cabinet Leaflet.

TERMS: Cash with order or C.O.D. Extra charge for C.O.D. U.K. and N. Ireland only.

(PW/O) 37 HILLSIDE, STONEBRIDGE, LONDON, N.W.10.

DULCI BAND 3 T.V. CONVERTER

★ ★ Type I.K.O. Patents ★ ★

A complete self-contained unit, suitable for converting all makes of T.V. Housed in a polished wood cabinet size 7in. x 10in. x 5 1/2in. All channels are iron core tuned with pre-set adjustments. Input signal equalising is provided. Valves 277, 277, 12AX7, 6X4. Power supply, A.C. Mains 200/250 volts. Service Data available on request. Price £9.9.0. Plus 3/6 post and packing.

★

F.M. & A.M./F.M. CHASSIS

Send for details of the latest types of High Quality V.H.F. Tuners and Amplifiers suitable for Band 2. Also, complete 4 Wave-Band 9 Valve Push-Pull A.M. F.M. Quality Radiogram Chassis.

★

DISC PLAYERS

Specially designed for the HI-FI enthusiast and home constructor. These Disc Players consist of the latest Three-Speed Automatic Record Changer, complete with crystal turn-over pick-up head for long-playing and standard records. This unit is mounted on a Sycamore veneered base which is complete with fitted Mains lead, and screened Pick-up lead, ready for connecting up. Brand new and boxed. Price £10.16.0. Plus 5/- Post and Packing.

THE "SUPEREX 55" ATTACHE PORTABLE

Building Cost £7.15.0, plus 3/6 P.P.



- ★ Really outstanding quality.
 - ★ Four Valve Battery Superhet.
 - ★ Long and Medium Wave-lengths.
 - ★ Perfect Reception in All Areas.
 - ★ Refined Cabinet 10 1/2in. x 8 1/2in. x 5 1/2in.
 - ★ Very Simple Construction.
- Send 1/3 for "Superex 55" Construction Booklet.

Shop open 9 a.m. to 6 p.m. Monday to Saturday. 1 p.m. Thursday.
Personal Shoppers Welcome.

Tel.: ELGar 3644.

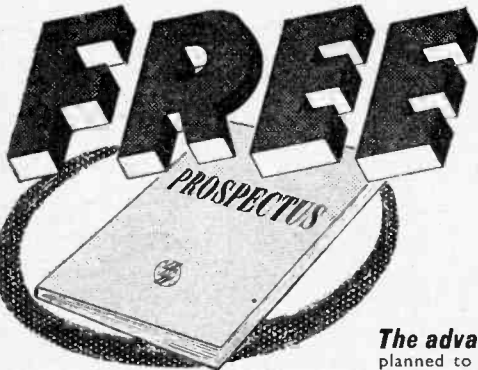

POST THE COUPON TODAY FOR OUR BROCHURE ON THE LATEST METHODS OF HOME TRAINING FOR OVER 150 CAREERS & HOBBIES

PRIVATE AND INDIVIDUAL TUITION IN YOUR OWN HOME

City and Guilds Grouped Certificates in Telecommunications: A.M. Brit. I.R.E. Examination, Radio Amateur's Licence, Radio and Television Servicing Certificates, General Radio and Television Courses, Radar, Sound Recording, etc. Also Courses in all other branches of Engineering and Commerce.

The advantages of E.M.I. training ★ The teaching methods are planned to meet modern industrial requirements. ★ We offer training in all subjects which provide lucrative jobs or interesting hobbies. ★ A tutor is personally allotted by name to ensure private and individual tuition. ★ Free advice covering all aspects of training is given to students before and after enrolling with us.

NEW LEARN THE PRACTICAL WAY

With many of our courses we supply actual equipment. Courses include: Radio, Television, Electronics, Draughtsmanship, Carpentry, Photography, and Commercial Art, etc.

Courses from 15/- per month

POST THIS COUPON TODAY

Send without obligation your FREE book.
E.M.I. INSTITUTES, Dept. 32K
43 Grove Park Road, London, W.4.
Phone: Chiswick 4417/8.

NAME _____

ADDRESS _____

OCT. _____
SUBJECT(S) OF INTEREST _____

EMI INSTITUTES
The only Postal College which is part of
a world-wide Industrial Organisation

TC18

USING TEST INSTRUMENTS

(Continued from page 634)

one of the voltages is not quite of the same frequency as the other it will gradually differ in phase by an increasing amount until it becomes first of all out of phase and then in phase again, and go on like this whilst producing a sequence of patterns as in Fig. 42.

Now, as the difference in frequency between the two voltages becomes greater the pattern sequence will speed up and the patterns will become confused,

but it will be observed that at certain points between the two frequencies other patterns resolve, and simple patterns will result each time an exact multiple of the two frequencies occurs.

Lissajous' Figures (36)

Patterns of this kind which are produced by the combination of two deflecting potentials are known as "Lissajous' Figures," after Professor Lissajous, who first created them by the reflection of light from two mirrors set at right angles to each other and then caused to vibrate. (To be continued)

News from the Clubs

LOTHIAN RADIO SOCIETY

Hon. Sec. : J. Good, 24, Mansionhouse Road, Edinburgh, 9.

At the recent annual general meeting, the following officers were elected:

President : Rev. W. M. Ferrier.

Vice-president : I. Mackenzie.

Treasurer : J. Good.

Meetings during the coming winter will be held at 25, Charlotte Square, Edinburgh, 2. On September 8th, the opening meeting for the season will include a discussion on Dx conditions on the amateur band.

BARNSELY AMATEUR RADIO CLUB

Hon. Sec. : P. Carbutt (G2AFV), 33, Woodstock Road, Barnsley.

THE programme for September will include the annual general meeting of the club on September 9th and a film show on September 23rd. Meetings are held at the King George Hotel, Peel Street, Barnsley.

SPEN VALLEY RADIO AND TELEVISION SOCIETY

Hon. Sec. : N. Pride, 100, Railes Lane, W. Leeds.

HAVING been in operation since 1947, the society now has 30 members and 21 associate members. Forthcoming items include:

September 21st : Supper for members and wives.

September 27th : Joint meeting of Leeds, Bradford and Spen Valley clubs at Cambridge House, Bradford, when a lecture on aerials will be given by M. J. Heoryside, B.Sc.

EDGWARE AND DISTRICT RADIO SOCIETY

Hon. Sec. : E. W. Taylor (G3GRT), 99, Portland Crescent, Stanmore.

MEETINGS are held every Wednesday evening at 8 p.m. at 22, Goodwyn Avenue, Mill Hill. Talks on a wide range of subjects of interest to the radio amateur are given and practical evenings and junk sales are also held regularly.

New members, especially beginners, are always welcome.

WIRRAL AMATEUR RADIO SOCIETY

Hon. Sec. : A. C. Wattleworth, 17, Iris Avenue, Claughton, Birkenhead.

MEETINGS are held on the first and third Wednesday of each month at 7.45 p.m., at the Y.M.C.A., Whetstone Lane, Birkenhead. Visitors and short-wave listeners are particularly welcome.

BRADFORD AMATEUR RADIO SOCIETY

Hon. Sec. : F. J. Davies, 39, Pullan Avenue, Eccleshill, Bradford.

THE Bradford Amateur Radio Society are arranging for classes to be held at the Bradford Technical College during the coming winter in preparation for the next Amateur Radio Examination.

Anyone in the Bradford district who would like to attend these classes is invited to contact the secretary.

CLIFTON AMATEUR RADIO SOCIETY

Hon. Sec. : C. H. Bullivant (G3DIC), 25, St. Fillans Road, Catford, S.E.6.

THE first Clifton transmitting field day, held on Sunday, July 24th, proved so popular that members have requested another contest later in the year. This has been fixed for October 2nd and will take place in the vicinity of Farnborough, Kent. Five stations took part in the first contest and the winner was C. Hatfull (G3HZ1), who used $\frac{1}{2}$ watt on 80 metres. Other contestants were G3DIC, G3FNZ, G3FVG and G3IWL, together with club members who acted as lookers, etc.

A small party of members were entertained at a local R.A.F. station on August 6th and were able to see and hear the V.H.F. air-to-ground communications system.

Programme for October :

2nd : Transmitting field day.

7th : Field day discussion.

14th and 28th : Constructional evening and ragchew.

21st : "Radio Frequency Cables," by Mr. R. J. Slaughter, of Telcon.

Meetings are held every Friday at 7.30 p.m. at the clubrooms, 225, New Cross Road, London, S.E.14. Details of membership can be obtained upon application to the hon. secretary.

RAVENSBORNE AMATEUR RADIO CLUB

Hon. Sec. : J. H. F. Wilshaw, 4, Station Road, Bromley, Kent

CLUB and classes re-open at the end of September at 8 p.m. every Wednesday evening. New club transmitter (G3HEV), a TA1240 watts on 80/40 with R1155 receiver will be in operation.

Committee members include G2DHV and G3FT1. Club exhibition will be held next May in conjunction with the Downham Men's Institute exhibition of work. New members are welcome to join the classes and those interested in amateur radio to join the club at the Science Room, Durham Hill School, Downham Estate.

COVENTRY AMATEUR RADIO SOCIETY

Hon. Sec. : J. H. Whitby (G3HDB), 24, Thornby Avenue, Kenilworth, Warwickshire.

MEETINGS are held at the Society's H.Q., 9, Queens Road, Coventry, starting 7.30 p.m.

The future programme includes :

Sept. 12th.—"Introduction to amateur radio"—G3HDP.

Sept. 26th.—Annual general meeting.

Oct. 10th.—Station descriptions.

Oct. 24th.—Mystery night.

TORBAY AMATEUR RADIO SOCIETY

Hon. Sec. : L. H. Webber (G3GDW), 43, Lime Tree Walk, Newton Abbot.

A MEETING was held at 7.30 p.m., at Y.M.C.A., Torquay, on July 16th, under the chairmanship of G2GK, who announced the programme for the 1955 winter season.

The R.S.G.B. Recorded Lectures have been reserved for the society, and one lecture will be played back each month, commencing on September 17th, with "V.H.F.," by Sir Noel Ashbridge. It is hoped that members will support these recordings in full strength.

We were all glad to hear that our member Bern Symons (BRS19991) was at last progressing favourably after a series of operations in hospital. He has been equipped during his stay there by one of the members, with a B2 receiver, and so has kept up his home practice.

THE GRAFTON RADIO SOCIETY

Hon. Sec. : A. W. H. Wennell (G2CJN), 145, Uxendon Hill, Wembley Park, Middlesex.

ARRANGEMENTS have again been made with the Islington L.C.C. Men's Evening Institutes for an official course of instruction for the Radio Amateurs' Examination to be held during the coming winter months at Grafton School, Eburne Road, Holloway, N.7, in conjunction with the Grafton Radio Society.

This year they have been granted an additional evening, Wednesday, and the full class (for beginners) is as follows:

Mondays : Radio Theory 7.9 p.m. ; Morse 9.10 p.m.

Wednesdays : Practical 7.9 p.m. ; Morse 9.10 p.m.

The full fee is 10s. Classes commence on Monday, September 26th (enrolment week Sept. 19th-23rd) under the instruction of Messrs. A. Perry (G3DKX) and L. Barber.

The Grafton Society also meets on Fridays at 7 p.m. for the usual club activities (including lectures by leading "Hams" and the trade) at which Morse will be available between 9.10 p.m. Application in the first instance should be made to the secretary.

Programme Pointers



Lesson For Younger Dramatists

AUNT BETSY'S BIRTHDAY," produced in *Saturday Night Theatre*, is a remarkable effort by Eden Phillpotts at the long past retiring age of 92. The story of how her covetous nephew and nieces, believing Aunt Betsy to be very wealthy, scheme to get their full whack of her fortune at her death—the old lady is eighty-odd—only to learn, when that event finally takes place, accidentally, that she actually had nothing, is told by Mr. Phillpotts with an amazing clarity of thought and logic that completely belie his great age. The plot, beautifully knit and compact, moves along with skill and adroitness, whilst the dialect is always terse and apt to the characters speaking it. Much wisdom and a rich experience keep coming through all the time.

The piece was very well produced by Owen Reed in the West of England studios and excellently played by Ethel Coleridge, Lewis Gedge, Aileen Mills, George Holloway and Norman Kendall. Younger dramatists in their sixties and seventies take note!

Morning Music

The programmes of early morning light music which regale us as we stir abroad at various times between 6.30 a.m. and 9 a.m. are always pleasant and invariably well played. They could, however, be very much more enjoyable if it wasn't for the BBC's great besetting sin of repetitiousness. When the infant child was born and christened, every god-father and godmother, aunt and uncle and Uncle Tom Cobby and all must have been whispering the same pieces of advice into the poor distracted parents' ears with the result that the child, all unbeknown, overheard and, now grown up, unconsciously executes the pre- and ante-natal gibberings that took place over and around his crib.

If we are weary unto death of certain classic masterpieces that will not take a vacation from our concert programmes for love or money, how much more so do many of us get at the rapid tinklings of nonsense such as the "Messenger Boy," "Siciliano," "The Galloping Major"—symphonically arranged—etc., not to mention more pretentious examples of the genre like Saint-Saens' Algerian Suite, the Ballet Music from Faust or the Perpetual Motion (Perpetual Performance?) of Johann Strauss. The repertoire of this kind of music is so enormous that it should be the easiest thing in the world for each performing combination to arrange that it will not repeat the same work twice in a year. But perhaps it doesn't matter so very much, after all. No good labouring the point when mother is far too busy getting father and the others off to work and to school.

Without ever quite evoking all the wit, gaiety and charm of the novel, Stafford Byrne's radio adaptation of Norman Douglas's brilliant "South Wind," nonetheless made a pleasant and effective Monday Night Theatre. Set on Capri, re-named "Nepenthe,"

Our Critic, Maurice
Reeve, Reviews Some
Recent Programmes

the inconsequential story is little more than a vehicle for some scintillating conversation and observation. Derek Guyler was a perfect Bishop and Alan McClelland, David Garth, Howieson Cuff, Barbara Leake and all the others, moved about the magic island with charm and effect. Barbara Couper as the American-born Duchess had been no nearer Vavasour than I have.

Stimulating Debate

Four recent Presidents of the Oxford and Cambridge Unions, under the chairmanship of an older one, Kenneth Adam, gave a highly stimulating debate on Public Schools under the generic title, "The Old School Tie." How extraordinarily divergent the views are on this interesting and important subject. Many famous men look back on their P.S. days with feelings and emotions ranging from violent hatred and contempt—such as Sir Osbert Sitwell's "educated during the holidays from Eton"—to reverential respect and affection. I liked the programme very much.

In a Saturday morning series of programmes comprising the entire collection of Bach's forty-eight preludes and fugues, Eric Harrison, usually a very good pianist, seemed to practise rather than play six of them. The fast ones, especially the C Sharp Major one, was so slow that it became difficult to believe it was really being played in public. The great C Sharp Minor was better, with the five voices clear and distinct.

Talking of fugues. I am reminded of two short stories. One, an American definition thereof, that it is a piece of music in which the parts enter one by one whilst the people walk out one by one. The other concerns a schoolboy howler. Asked to say something of J. S. Bach, a bright young scholar said, "Born 1685, died 1750, had two wives, seventeen sons and forty-eight preludes and fugues!"

No "Disc Jockey"

"Your Concert Choice," the Sunday morning miscellany of records of musical masterpieces, seems to me easily the best of the many programmes of gramophone records constantly being put over. Chiefly because it is never under the charge of a "disc jockey." Listeners are left to judge and appraise the music for themselves and not as Bob this or Doreen that would like them to. There is no bally-hoo, just a few sober facts given out by someone who knows his job. Alec Robertson presides over these programmes ideally.

R.S.C. A4 HI-FIDELITY 25 WATT AMPLIFIER

1955 Model "Push-Pull" output. "Built-in" Tone Control Pre-amp. stages. Increased sensitivity. Even further improved performance figures. Includes 7 valves, specially designed sectionally wound output transformer, rock paper reservoir condenser and reliable small condensers of current manufacture. TWO SEPARATE INPUTS CONTROLLED BY SEPARATE VOLUME CONTROLS allow simultaneous use of "Mike" and Gram or Tape and Radio, etc. etc. INDIVIDUAL CONTROLS FOR BASS AND TREBLE "Lift" and "Cut." Frequency response ± 3 db. 30-30,000 c/c. Six negative feedback loops. Hum level 66 db. down. ONLY 3 millivolts INPUT required for FULL OUTPUT. Certified harmonic distortion only 0.35% measured at 10 watts. Comparable with the very best designs.

ENTIRELY SUITABLE FOR SMALL HOMES OR LARGE HALLS, CLUBS, GARDEN PARTIES, DANCE HALLS, etc. etc. For ELECTRONIC ORGAN or GUITAR. For STANDARD or LONG-PLAYING RECORDS. FOR ANY "MIKE" or PICK-UP. H.P. TERMS ON ASSEMBLED UNITS. DEPOSIT 26/- and twelve monthly payments of 1/-.

A PUSH-PULL 3-4 watt HIGH-GAIN AMPLIFIER FOR £3.19/6. For mains input 200-250 v. 50 c/s. Assembled ready for use. Amplifier can be used with any type of Picked-Up or Pick-Up. This is not A.C./D.C. with "live" chassis, but A.C. only with 400-0-400 v. trans. (Output is for 2-3 ohm speaker.) Carr. 3/6. Descriptive leaflet, 7d.

COLLARO 3-SPEED AUTO-CHANGER. For standard 200-250 v. 50 c/s mains. Fitted high-fidelity crystal pick-up with separate plug-in heads with sapphire point stylus for long-playing or standard records. 7in., 10in. or 12in. Limited number. Brand New. Guaranteed. £7/10/6. Carr. 7/6.

DEFIANT RECORD PLAYING UNITS Turntable for standard 10in. and 12in. 78 r.p.m. records (fitted auto-stop) and high impedance magnetic pick-up, mounted in attractive polished walnut finish drawer-type cabinet. Exceptional value at £5/10/6 plus 7/6 carr.

B.S.R. MONARCH 3-SPEED MIXER AUTOCHANGER. For standard 200-250 v. 50 c/s mains. Autochanges on all 3-speeds. Plays Ten mixed 7in., 10in. and 12in. records. Separate sapphire stylus for L.P. and 78 r.p.m. High fidelity type crystal pick-up. Minimum baseboard size needed 14in. x 12in. x 5 1/2in. Brand new, cartoned, at 9 gns. plus 5/6 carr. Or Deposit 4 gns. and six monthly payments 21/-.

COLLARO HIGH FIDELITY MIXER AUTOCHANGERS. Latest Model RC/54 Fitted Studio "O" high fidelity pick-up with dual point sapphire stylus for standard or long-playing records. Plays Ten 7in., 10in. or 12in. intermixed at 33 1/3, 45 or 78 r.p.m. For 200-250 v. 50 c/s. A.C. mains. Brand New. Cartoned at less than wholesale price. Only 10 gns. Carr. 7/6 or Deposit 4 gns. and 7 monthly payments 1/-.

BATTERY SET CONVERTER KIT A.A. parts for converting any type of Battery receiver to All Mains. A.C. 200-250 v. 50 c/s. Kit will supply fully smoothed H.T. or 120 v. 90 v. or 60 v. at up to 40 mA. and fully smoothed L.T. or 2 v. at 0.4 to 1 a. Price, complete with circuit wiring diagrams and instructions, only 48/9. Or ready to use, 8/9 extra.

ALL DRY BATTERY RECEIVER MAINS UNIT KIT. A complete set of parts for construction of a Unit (housed in metal case) to replace B series where A.C. Mains supply is available. Input 200-250 v. 50 c/s. For receivers requiring 90 v. 10/20 mA. and 1.4 v. 125-250 mA. fully smoothed. Price, complete with circuit, only 37/9. Or ready for use 45/6. Size of unit, 5 1/4 x 2 1/2in.

Terms : C.A.O. or C.O.D. NO C.O.D. under £1. Post 1/- extra under 10/-; 1/6 extra under 11/-; 2/6 extra under £3. Open 9 to 5.30 : Sat. until 1 p.m. Catalogue 6d., Trade List 5d. S.A.E. with all enquiries.

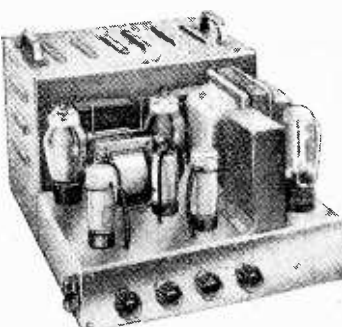

Size approx. 12.9-7in. For A.C. mains 200-250 v. 50 c/s. Outputs for 3 and 15 ohm speakers. Kit is complete to last nut. Chassis is fully punched. Full instructions and point-to-point wiring diagrams supplied. Unapproachable value at 9 gns. or ready for use, 50/- extra. (Carriage 10/- if required, cover as illustrated can be supplied for 17/6.

H.M.V. LONG-PLAYING RECORD TURNABLE WITH CRYSTAL PICK-UP (Sapphire Stylus). Speed 33 1/3 r.p.m. For A.C. mains 200-250 v. Limited supply. Brand New, cartoned. Perfect. Only £3/19/6. Plus carr. 5/- (Normal price £8 approx.)

FOUR STAGE RADIO FEEDER UNIT. Design of a High Fidelity Tuner Unit T.R.F. L. & M. Wave. Full decoupling. Self-contained heater supply. Only 250-400 v. 10-15 mA. H.T. required from main amplifier. Three valves and low distortion Germanium diode detector. Flat-topped response characteristic. Loaded H.F. coils. Two variable-Mu controlled H.F. stages. 3-Gang condenser tuning. Detailed wiring diagrams, parts lists, and illustration. 2/6. Total building cost £3/15/-.

R.S.C. 4-5 WATT A5 HIGH-GAIN AMPLIFIER

A highly sensitive 4-valve quality amplifier for the home, small club, etc. Only 50 millivolts input is required for full output so that it is suitable for use with the latest high-fidelity pick-up heads, in addition to all other types of pick-ups and practically all mikes. Separate Base and Treble Controls are provided. These give full long-playing record equalisation. Hum level is negligible being 71 D.B. down. 15 D.B. of negative feedback is used. H.T. of 300 v. 25 mA. and L.T. of 6.3 v. 1.5 a. is available for the supply of a Radio Feeder Unit, or Tape Deck preamplifier. For A.C. mains input of 200-250 v. 50 c/s. Chassis is not alive. Kit is complete in every detail and includes fully punched chassis (with baseplate), with green crinkle finish, and point-to-point wiring diagrams and instructions. Exceptional value at only £4/15/-, or assembled ready for use 25/- extra, plus 3/6 carr.



R.S.C. MASTER INTERCOMM. UNIT. For Office or Works Intercommunication. High Gain Amplifier with Push-Pull output. Attractive wood walnut cabinet. Provision for 4 individually switched Listen-Talk Back Units can be supplied in walnut veneered cabinets at 35/- each. Master Unit ready for use, 7 gns. Carr. 2/6.

R.S.C. 10 WATT "PUSH-PULL" HIGH-FIDELITY AMPLIFIER A3

Ideal for the quality enthusiast in the home or small hall. Two different inputs can be simultaneously applied and controlled by separate volume controls. Any kind of Pick-up is suitable and most microphones. Tone controls give full Long-Playing record equalisation for uncorrected Pick-ups. Selectivity is very high. Only 130 millivolts required for full output. H.T. and L.T. available for Radio Feeder unit.

Complete with integral Pre-amp. Tone control stage (as A4 amplifier), using negative feedback, giving hump-proof individual bass and treble lift and cut tone control. Six Negative Feedback Loops. Completely negligible hum and distortion. Frequency response ± 3 db. 30-20,000 c.p.s. Six valves. A.C. mains 200-250 v. Input only. Outputs for 3 and 15 ohm speakers. Kit includes 7 gns. of parts complete in every detail. Plus 7/6 carriage. Or ready for use, 45/- extra. Illustrated leaflet 6d. Cover as for A4 is suitable. H.P. TERMS ON ASSEMBLED UNITS. DEPOSIT 23/6 plus 10/- carriage, and nine monthly payments 1 gn. HIGH-FIDELITY MICROPHONES in stock. Keep cash prices or H.P. terms if supplied with amplifier.

P.M. SPEAKERS. All 2-3 ohms, 6 1/2in. Plessey, with 5,000 ohm output trans. 16/9. 8in. Plessey, 16/9. 10in. W.B. "Stentorian" 3 or 15 ohm type HF1012 10 watts, high-fidelity type. Highly recommended for use with any of our amplifiers, £3/17/6.

M.E. SPEAKERS 2-3 ohms, 8in. R.A. Field. 600 ohms, 11/9. 10in. R.A. Field. 1,000 ohms, 23/9.

VOLUME CONTROLS with long (1in. diam.) spindles, all valves less switch, 2/9; with S.P. switch, 3/9; with D.P. switch, 4/6.

COAXIAL CABLE 75 ohms, 1in., 8d. yard. Twin Screened Feeder, 10d. yard.

SELENIUM RECTIFIER

L.T. Types	H.T. Types H.W.
6-12 v. 4 a. H.W.	150 v. 40 mA. 3/9
	250 50 mA. 6/9
F.W. Bridge Type	250 v. 80 mA. 7/9
6/12 v. 1 a. 4/9	RM4 250 v.
6/12 v. 6 a. 10/9	250 mA. 11/9

R.S.C. 3-4 WATT A7 HIGH-GAIN AMPLIFIER

Appearance and Specification, with exception of output wattage, as A5. Complete Kit, with diagrams, £3/15/-, Assembled £1 extra. Carr. 3/6.

PICK-UPS. Collaro high fidelity low impedance magnetic type, with matching transformer. Only 35/-, Goldring high impedance magnetic £23/9. Both types Brand New Boxed.

CHASSIS (Undrilled Aluminium)

18 s.w.g. amplifier (4-sided)	
14in. x 10in. x 3in.	7/11
16in. x 10in. x 3in.	8/3

BATTERY CHARGER KITS For mains 200-250 v. 50 c/s. To charge 6 v. acc. at 2 a., 25/6. To charge 6 or 12 v. acc. at 2 a., 31/9. To charge 6 or 12 v. acc. at 4 a., 48/9. Above consist of transformer, full wave rectifier, fuses, fuseholders and steel case. Any type assembled and tested, 6/9 extra.

THE SKYFOUR T.R.F. RECEIVER. A design of a 3-valve 230-250 v. A.C. Mains receiver with selenium rectifier. It consists of a variable Mu. high-gain H.F. stage followed by a low distortion anode bend detector. Power pentode output is used. Valve line up being 6K7, SP61, 6FG6. Selectivity and quality are well up to standard, and simplicity of construction is a special feature. Point to point wiring diagrams, instructions, and parts list. 1/9. This receiver can be built for a maximum of £4/10/6 including attractive Brown or Cream Bakelite or Walnut veneered wood cabinet 12 x 6 1/2 x 5 1/2in.

RADIO SUPPLY CO. (LEEDS) LTD. 32, THE CALLS, LEEDS, 2

**Decidedly NOT
just an ordinary
receiver!**

The Eddystone '840A'

has a true communications specification ensuring consistent long-distance reception.

**NEW BANDSPREAD DEVICE
LONG OPEN SCALES
34 FEET OF BANDSPREAD
ON EACH OF 4 RANGES
COVERS 30.6 Mc/s - 480 kc/s
(9.8 - 625 Metres)**

- Accurate tuning and station re-setting
- Beat Frequency Oscillator
- Internal loudspeaker
- Special aerial input for 400 ohms twin OR single wire
- High sensitivity
- Rugged "BATTLESHIP" construction, works equally well from AC or DC mains

£49 or on WEBB'S EXTENDED PAYMENTS

Deposit **£16.68** and 12 payments of **£2.19.11** or 18 payments of **£2.1.9.**

You can hear the world on the '840A'... descriptive brochure post free on request from Webb's Radio.

★ ★ ★ ★ ★ ★ ★ ★ ★ ★
and the latest development from the **ROGERS LABORATORY**
ROGERS 'RD Junior'
AMPLIFIER

For **'HI-FI'** at a reasonable price

£26 Complete with Pre-amp.

or on WEBB'S EXTENDED PAYMENTS
Deposit **£8.13.4** and 12 payments of **£1.11.10** or 18 payments of **£1.2.2.**

A POSTCARD BRINGS YOU A 12 PAGE BROCHURE—YOU WILL SEE IT HAS ALL THE FACILITIES GIVEN BY OTHER OUTFITS COSTING DOUBLE.

**WEBB'S
Radio**

14 SOHO ST., OXFORD ST., LONDON, W.1
Telephone: GERrard 2089.

Shop Hours:
9 a.m.—5.30 p.m. Sats. 9 a.m.—1 p.m.

BUILD THIS FOR £5. 7. 6.!

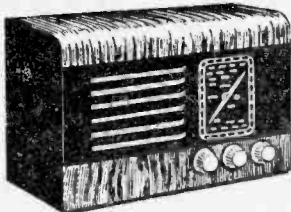

Total building cost including choice of beautiful walnut veneered cabinet or ivory or brown bakelite. This is the lowest possible price consistent with high quality. No radio knowledge whatever needed... can be built by anyone in 2-3 hours, using our very simple, easy-to-follow diagrams. This terrific new circuit covers all medium and long waves with optional negative feedback, has razor-edge selectivity, and exceptionally good tone. Price also includes ready drilled and punched chassis, set of simple, easy-to-follow plans—in fact, everything! All parts sparkling brand-new—no junk! Every single part tested before despatching. Uses standard octal-base valves: 6K7G high-frequency pentode feeding into 6J5G anode-bend detector triode, coupled to 6V6G powerful output beam-power tetrode, fed by robust rectifier. For A.C. Mains, 200-250 Volts (low running costs—approximately 18 Watts!) Size 12in. x 6in. x 5in. Build this long-range, powerful midget NOW. Send 2/- for priced parts list, testimonials, etc., or send **£5.7.6** for all parts and set of plans. (Add 2/6 for packing and post.) C.O.D. 1/6 extra. All orders despatched without carefully packed.
BRIGHTON RADIO CO. (Dept. PK6), 69, PRESTON STREET, BRIGHTON, I.

Television Receiver Servicing Vol. 2.

RECEIVER AND POWER SUPPLY CIRCUITS.

by E. Spreadbury.

The Video Stage Vision A.C.C.
Vision Interference The Sound Channel
Suppression Power Supplies
The Vision Detector Aerials and Feeders
Tuning Circuits Reflections and
Multi-Channel "Ghosting"
Tunners Circuit Alignment
21s. Od. net, postage 9d.

T.V. Precautions for Bands I & II.
by B. L. Morley, 5/-, postage 3d.

Practical Wireless Service Manual,
by F. J. Camm, 17/6, postage 6d.

Basic Radio Course, by J. T. Frye,
18/-, postage 6d.

Radio Valve Data, compiled by "Wire-
less World," 3/6, postage 3d.

The Radio Amateur's Handbook, by
the A.R.R.L. Staff, 30/-, postage 1/-.

THE
MODERN BOOK CO.

BRITAIN'S LARGEST STOCKIST OF
BRITISH AND AMERICAN TECHNICAL
BOOKS

19-23, PRAED STREET
(Dept. P.10), LONDON, W.2.

Phone: PADdington 4185. Open 6 days
9-6 p.m.

Best Buy at Britain's

COMMUNICATION RECEIVER PCR2.—Ex-government surplus manufactured by Pye Ltd. Three wavebands 12-50, 190-570 and 900-2,000 metres. Line-up: RF—EF39, FC—XG1, 2 IF's—EF39, Det., AVC, 1st AF—EB33, Output—6V6. In black case size 17 1/2 in. x 9 1/2 in. x 8 in., with crackle front, illuminated calibrated dial, fly wheel tuning, aerial trimmer. Requires power supply and low impedance speaker. In first class condition, complete with all valves, **£4.19.6.** plus 10/6 carriage. **SPECIAL OFFER**—can be supplied with built in A.C. mains power pack, fully re-aligned and tested for **£3 extra**

RECEIVER R1132A.—Covers 100-124 Mc/s with variable tuning. Ideal for conversion to F.M. Complete with 11 valves and circuit diagram. Brand new, all valves, **£4.19.6.** plus 10/6 carriage. **SPECIAL OFFER**—can be supplied with limited number these are available for callers only. Price 65/-.

COMMUNICATION RECEIVERS TYPE R1155A.—For world-wide reception. Brand new and air-tested. **£11.19.6.** Slightly soiled. **£9.19.6.** Use 10 valves. **£7.19.6.** **R1155B** with super slow motion drive, brand new, **£12.10.0.** Carriage 10/6 extra. Free booklet supplied with each receiver.

A.C. MAINS POWER PACK & OUTPUT STAGE.—These enable the R1155 to be used on the mains WITHOUT ANY MODIFICATION. Three types available: **£4.19.6.** **£5.5.0.** and de-luxe model with 8in. speaker. **£6.10.0.** Carriage 5/-. All Power Packs guaranteed six months. **SAVE £££. DEDUCT 10/- WHEN PURCHASING RECEIVER AND POWER PACK TOGETHER.** Send S.A.E. for full details of Power Packs and Receivers or 1/3 for booklet.

RECEIVER TYPE CR100.—A super communications receiver covering 60 kc/s to 30 mc/s in six bands. Built-in A.C. mains power pack—2 EF39, 3 1/2 F. stages, variable selectivity Xtal Filter, B.F.O., etc. Super condition, complete with new valves and air tested. A bargain at **£30**, plus **£1** carriage.

RECEIVER 25 73 (TR1196).—Superhet receiver with 45 kc/s I.F.s. Complete with all valves: 2 EF39, 1 EK32, 2 EF36, 1 EB33. Brand new with full conversion data. Price 30/-, price 2/6 post.

AVO "ALL DRY" BATTERY ELIMINATOR.—Government surplus. For A.C. mains 200/250 volts, output 1.4 v. at 300 mA, and 65 volts at 10 mA. Employs metal rectifiers and VS70 stabiliser. Size 8 1/2 in. x 5 1/2 in. x 3 1/2 in. Suitable for all personal portable type sets, full instructions supplied. New. In cartons and all tested prior to despatch. Price 39/6, plus 2/6 post.

H.R. HEADPHONES.—Consists of two high-resistance earpieces with adjustable metal headbands. Price, less cord, 6/6.

PACKARD BELL PRE-AMPLIFIERS.—Suitable for conversion to baby alarm, amplifier, etc. Contains miniature relay. Complete with 6S17, 2B17. Circuit, Instruction Book, etc. BRAND NEW. S.A. 12/6 each.

R.C.A. AMPLIFIER.—For A.C. mains operation 190/250 v. 12 watts output into 600/15 7.5/5 ohms, input impedances of 250 and 30 ohm, suitable for mike and gram. Brand new, in handsome case, size 17 in. x 9 in. x 1 1/2 in. deep. Uses 4-6J7, 2-6L6 and 5U4. Price ONLY **£9.19.6.** less valves, or **£12.19.6.** with boxed valves, carriage 10/6.

MINIATURE MODEL MOTORS.—2in. long x 1 1/2 in. diam., 3/16in. diam. spindle, weight 5 ozs. Will work from 6-volt dry battery and are reversible. Ball bearings. 10/6 each. With blower, 12/6 each.

METER BARO-METER.—Projection type. Two ranges, 12 and 120 volts, with multiplier. Brand New and Boxed, 5/9 each.

E.M.I. OUTPUT METER.—Desk Type, consists of 2 1/2 in. 1 mA. meter with full wave bridge rectifier. Range 0-500 milli-watts and 0-5 watts. Brand New and Boxed. ONLY 35/- each, plus 1/6 post.

EDDYSTONE ROTARY POWER UNITS.—In grey metal case. Input 12 v., output 180 v. at 60 mA. Complete with all smoothing and filtering. BRAND NEW, 18.6. plus 2/6 postage.



**CHARLES BRITAIN
(RADIO) LTD.**

11, Upper Saint Martin's Lane, London, W.C.2. TEM 0545

Shop hours 9-6 p.m. (9-1 p.m. Thursday)
— OPEN ALL DAY SATURDAY —

Open to Discussion



How Many Turns?

SIR,—In his most interesting and useful article "How Many Turns?" in your August issue N. F. Back gives two formulæ for the calculation of windings in terms of inductance and dimensions. He later proceeds to use one of these formulæ, but an inspection of his calculation shows immediately that there is something wrong with the formula as quoted, since

$$n = \frac{15 \times 175 (2 + (3 \times 2\frac{1}{2}))}{2}$$

works out to a total of over 12,000 turns, instead of the figure of 80 (approximately), which is given as the result.

On taking a rough check on the other formula (for wave-wound coils), using the dimensions of a commercial coil, and assuming an inductance of 175 μ H for medium wave, there is a similar error, as the result obtained, $n=8,000$ turns (approximately), is again obviously absurd.

I find that in textbooks where formulæ for the calculation of inductance in terms of dimensions and number of turns appear these terms are always "squared," and since such "squarings" do not just disappear when the formula is transposed I imagine that some of them have been omitted from the formulæ quoted.

It is possible to reach the result given by the author for the dimensions quoted by assuming that this is the case, and amending the original formula to read

$$n^2 = \frac{15L(a+3b)}{a^2} \quad \text{or} \quad n = \frac{\sqrt{15L(a+3b)}}{a^2}$$

It will be interesting to know whether this assumption is correct, and whether a similar amendment is necessary to correct the other formula given in the article.—J. K. CONSTABLE (Laboratory Technician, Physics Dept., Coventry Technical College).

(I must apologise to readers for the error which appeared in the "How Many Turns?" article. What has happened is that the square root sign was not printed above the numerators in each equation. Since I corrected the rough proofs of the article, this is, of course, an omission on my own part.)

To read correctly the formulæ concerned should be as follows:

1. $n = \frac{\sqrt{15L(a+3b)}}{a}$ and
2. $n = \frac{\sqrt{5L(3a+9b+10c)}}{a}$

In the second article the worked example will then read:

$$n = \frac{\sqrt{5 \times 2,200[(3 \times 2\frac{1}{2}) + (9 \times 1) + (10 \times \frac{1}{2})]}}{2\frac{1}{2}} = 200 \text{ approximately.} \text{—N. F. BACK.}$$

Valve Standardisation

SIR,—I read with great interest Mr. Masters' letter on the standardisation of valve bases. There is, I feel sure, nobody who will dispute that standardised valve bases would be what Sellars and Yeatman would call a "good thing." I am surprised, therefore, that the subject has hitherto been little mentioned in your columns. Quite recently, moreover, many people have accused the B.V.A. of being

a price ring, interpreting this word in its worst possible sense. This has led to an extremely uncomfortable political situation and I feel that if this association were to bring forward proposals for this standardisation they could not come at

a more opportune moment. Thereby, the association would demonstrate quite clearly that it does, in fact, serve the interests of the consumer and that their common agreement means more than just financial juggling.

You, in your footnote to the letter, raise the inevitable question as to which valve base should be adopted. However, any attempt to invent a new standard valve base must, like the attempt to found a universal language, be doomed to failure. For, obviously, any attempt of this nature must try to involve the minimum of capital expenditure and the minimum of reorganisation within the industry. That very fact alone must limit the choice to those valve bases which are most used at the present time. To my mind, the international octal and the B9A would be best suited.

It is not long since the standardisation of wood-screws was achieved; why should valves not be standardised? The outcome could be only good.—EXPERIMENTER.

An Economical 'Gram Amplifier

SIR,—Mr. Harrison accuses me in his letter of using "a monster triode" to avoid having the constructor baffled by feedback loops. If Mr. Harrison can tell me what is monster about a 5-watt triode I shall be very pleased to hear it.

Further, if Mr. Harrison's experience is as wide as he makes it sound in his letter he ought to know that the "single resistor and wire" involved in his rather unique conception of a feedback loop is the very thing which by reason of its apparent simplicity trips up the inexperienced amateur, even if he can master the complexities of a superhet circuit before the detector.—S. A. KNIGHT (Chelmsford).

Whilst we are always pleased to assist readers with their technical difficulties, we regret that we are unable to supply diagrams or provide instructions for modifying surplus equipment. We cannot supply alternative details for receivers described in these pages. WE CANNOT UNDERTAKE TO ANSWER QUERIES OVER THE TELEPHONE. If a postal reply is required a stamped and addressed envelope must be enclosed with the coupon from page iii of cover.

Small Mains Transformers

SIR,—With reference to Mr. R. H. Borthwick's article in September's PRACTICAL WIRELESS, I feel I must make a few comments.

First, the article is too short and just about "whets the appetite" without giving enough detail; secondly, here are a number of statements open to criticism. These I will deal with in turn.

Laminations are more usually .020in. thick these days as this gives a quicker assembly time and a better nett to gross area. It should also be remembered that the "E and I" type are used as often as the "T and V" type shown.

The formula $A = \frac{\sqrt{W}}{55.8}$ sq. in. is all very well for a lamination of particular proportions, but there are so many different types that it just will not work in every case. A lamination having the same centre limb but only half the winding space as that shown will clearly only have half the VA capacity for the same stack thickness.

With regard to windings, providing all have the same current density, the heat loss per unit volume is identical and the reason thick wire is put on last is so that sharp bends will be avoided which might damage the insulation.

Two thousand amps per sq. in. for all windings is, in my opinion, too high, and 1,500 is safer. In the example given no mention is made of the primary gauge to be used, and it must be remembered to take into account the efficiency and the magnetising current.

The turns per volt figure of 6 given for a core of 1 sq. in. cross section (presumably a gross figure) gives a flux density of nearly 13,000 gauss (or lines per square centimetre). This is too high for an air-cooled transformer as it gives excessive eddy current and hysteresis losses (with consequent overheating) and a high magnetising current. A figure of 7 is, in my opinion, much more sensible.

Finally, with regard to the electrostatic screen, a complete turn must not be made as a short-circuited turn will make all efforts in vain!

The design of a mains transformer is based on long experience, coupled with a large amount of trial and error experiment, and is best left to experts. However, much fun can be had and knowledge gained by playing about with laminations and bits of wire so long as you are not too disappointed with the results.—H. L. BROWN (Walsall).

I.F. of Ex-Service Sets

SIR,—In reply to a query in the August issue of PRACTICAL WIRELESS concerning frequency ranges and I.F. values of ex-W.D. radio receivers I hope the following details will be of use to readers. I am afraid that I have not been able to find all the

I.F.s or determine whether superhet or T.R.F., but trust the information will be of help.

I would also like to thank you for an interesting publication and wish you all the best for the future. —JOHN F. MILLS (Greatworth, Oxon).

Rx	Frequency range	I.F.
Type 18	6.9 Mc/s	465 kc/s
Mk. III		
R208	10-60 Mc/s	?
R1147B	200 Mc/s approx.	?
OCT-46145	520 kc/s-1,500 kc/s	?
Type 3/11	3.0-16.0 Mc/s	?
R107	1.2-3.0 Mc/s	465 kc/s
	2.95-7.25 Mc/s	
	7.0-17.5 Mc/s	
BC453B	190-550 kc/s	85 kc/s
BC454B	3.0-6.0 Mc/s	1,415 kc/s
BC455B	6.0-9.1 Mc/s	2,830 kc/s
MCR1	100-1,600 kc/s	?
	2.5-5.0 Mc/s	
	4.5-8.0 Mc/s	
	8.0-15.0 Mc/s	
R1132A	100-124 Mc/s	12 Mc/s
B2, Mk. III	3.1-15.5 Mc/s	?
BC 348	200-500 kc/s	?
	1.5-18.0 Mc/s	
Type 48	6.9 Mc/s	?
Type 25/73	4.3-6.7 Mc/s	460 kc/s
R21	4.2-7.5 Mc/s	?
	18-31 Mc/s	
R68	3.0-5.0 Mc/s	465 kc/s
ZC8931	Approx. 150 Mc/s	12 Mc/s
TR9	31-80 metres	?
Type 6	3.0-7.0 Mc/s	?
U.F.2	Approx. 70 Mc/s	?
R1124	30.5-40.0 Mc/s	7 Mc/s
R1155	18.5-7.5 Mc/s	
	7.5-3.0 Mc/s	560 kc/s
	1,500-600 kc/s	
	500-200 kc/s	
AEW1	12-50 metres	?
	188-545 metres	
Type 78	2.4-5.9 Mc/s	?
	5.8-13.0 Mc/s	
R1545	75-215 metres	?
RA-1B	0.15-0.315 Mc/s	?
	0.315-0.680 Mc/s	
	0.680-1.5 Mc/s	
	1.8-3.7 Mc/s	
	3.7-7.5 Mc/s	
	7.5-15.0 Mc/s	
Type 58	6.9 Mc/s	?

Radar Units	I.F.
R3102A	45 Mc/s
R184	45 Mc/s
R3515	14 Mc/s
R1355	7.5 Mc/s
R3084	30 Mc/s

Editorial and Advertisement Offices: "Practical Wireless," George Newnes, Ltd., Tower House, Southampton Street, Strand, W.C.2. 'Phone: Temple Bar 4388. Telegrams: Newnes, Rand, London. Registered at the G.P.O. for transmission by Canadian Magazine Post.

The Editor will be pleased to consider articles of a practical nature suitable for publication in "Practical Wireless." Such articles should be written on one side of the paper only, and should contain the name and address of the sender. Whilst the Editor does not hold himself responsible for manuscripts, every effort will be made to return them if a stamped and addressed envelope is enclosed. All correspondence intended for the Editor should be addressed: The Editor, "Practical Wireless," George Newnes, Ltd., Tower House, Southampton Street, Strand, W.C.2. Owing to the rapid progress in the design of wireless apparatus and to our efforts to keep our readers in touch with the latest developments, we give no warranty that apparatus described in our columns is not the subject of letters patent. Copyright in all drawings, photographs and articles published in "Practical Wireless" is specifically reserved throughout the countries signatory to the Berne Convention and the U.S.A. Reproductions or imitations of any of these are therefore expressly forbidden. "Practical Wireless" incorporates "Amateur Wireless."

W & L COMPONENTS LTD.

8 CAMDEN HIGH STREET, LONDON, N.W.1
Tel.: EUSon 7844. (near Mornington Crescent Underground)

F M TUNER

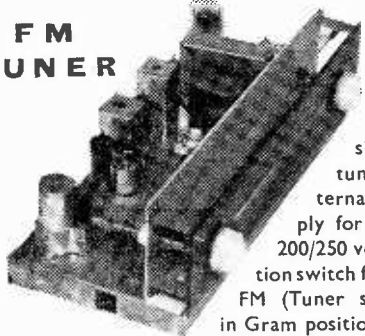

★ An extremely sensitive 5-valve tuner with internal power supply for A.C. mains 200/250 volts. 2-position switch for Gram and FM (Tuner switched off in Gram position).

Permeability tuned and temperature compensated against drift.

★ Geared drive with illuminated calibrated dial. Valve line up:—ECC85 twin triode as grounded grid R.F. stage and mixer. 6BJ6 I.F. amplifier, 6BJ6 limiter, 6AL5 ratio detector, 6V4 rectifier. Your existing radio or amplifier converted to FM in a few minutes.

Price
£13. 15. 0
complete
(including tax)
Carriage and
packing 7/6 extra

WRITE FOR FULL PARTICULARS TO DEPT. A.1.

G2AK This Month's Bargains G2AK

ABSORPTION WAVEMETERS.—3.00 to 35.00 Mc/s in 3 switched bands. 3.5, 7, 14, 21 and 28 mc/s Ham bands marked on scale. Complete with indicator bulb. A MUST for any Ham Shack. ONLY 15/- each. P. & P. 1/-.

TEST METER.—7 ranges as follows: 1.5 v., 3 v., 150 v. 6 mA., 60 mA., 5,000 ohms, 25,000 ohms 2½ in. dia. scale M.C. meter. Rotary selector switch. Black bakelite case, 6 x 4½ x 4½ fitted with removable lid, also provision for internal batts., ranges can be easily extended. Bargain price 30/-, plus 1/6 post.

VALVES.—B7G base, 1T4, 1S5, 1R5, 1S4, 3S4, 3V4, 1/6 ea., or 4 for 27/6. Most of the 1.4 v. B7G range available at 8/6 ea.

HEADPHONES.—Low resistance type CLR No. 3, 9/6. DLR No. 2, 13/6. High resistance and the most sensitive of all DHR, No. 5B, 18/6 per pair, P. & P. 1/- pair.

FSK SOLARISCOPIES.—Complete with charts. Give World time, light and darkness paths. Invaluable to the DX man. List 21/-, our price 7/6, post free.

PANL Home Crackle.—Black, Brown or Green, 3/- tin. P. & P. 8d.

FOR THE NEW MOBILE.—12 v. Miniature Rotary Transformers. Output 360/310 v., 30 mA., C.S. or 70 mA. I.C.A.S. Only 4½ in. x 2½ in. overall. Only 17/6 ea., or 30/- for 2. P. & P., 1/6.

UNREPEATABLE VALVE OFFER

Genuine American 807's, 6/- ea. or 4 for £1. Photomultipliers. Type 931A. 35/- ea. or 2 for £3.

Postage free on all orders over £1 except where specifically stated. PLEASE PRINT YOUR NAME AND ADDRESS.

C. H. YOUNG, G2AK

All callers
110, Dale End
Birmingham 4 (CEN 1635)

Mail Orders to Dept. "P"
102, Holloway Head,
Birmingham 1 (MID 3254)

CLYNE RADIO LTD.



18, TOTTENHAM COURT RD.
LONDON, W.1

MUSEUM 5929/0065.
(50 yards only from Tottenham Court Road Tube!)
All post orders please to:—

24-26, HAMPSTEAD RD., LONDON, N.W.1. EUSon 5533, 4 5.

RECEIVER TYPE 25,73. (The receiver section of TR1196.) Supplied complete with full data for conversion to 3-wave superhet receiver. Unit is complete with 6 valves 2-EP39, 2-EP36, PK32 and EBC33, also standard I.P.T.s 465 Kc/s. Price 27/6 plus 2/6 P. & P.

TR1196 TRANSMITTER PORTION. We can also supply the transmitter portion of the above receiver incorporating valves, EL32, EP50, CV501, Type 600 relay transformer, coils, switches, etc. Limited quantity at 12/6 only, plus 2/6 P. & P.

No. 17 Mk. II TRANSMITTER/RECEIVER. Built into a strong wooden cabinet 15in. x 14in. x 9in. Complete with headphones and microphone. Range 5-8 miles with simple aerial. 44-61 m/cs. (3-7 metres.) Uses standard 120 v. H.T. and 2 v. L.T. batteries. Illustrated instruction book supplied with each unit. 50/- each plus 7/6 post and packing.

No. 38 TRANSMITTER/RECEIVER WALKIE-TALKIE. 1 range approx. 5 miles. Coverage 7.4-9 Mc/s. The set only, complete with valves at 30/-, in very good condition.

I.F. TRANSFORMERS SPECIAL OFFER. All iron-cored 465 Kc/s. Philips size 2½ in. x 1½ in. diameter (cylindrical), 7/6 pair. By Invicta—Cylindrical 2½ in. x 1½ in. diameter, 8/6 pair. Also our own special ultra midget size 1½ in. x 1½ in. x 1½ in. Only 9/9 per pair. By Wearite, Type 501 and 502 12/6 per pair. MS90 12/6 pair.

MAINS TRANSFORMER BARGAINS! Limited quantities only. Manufacturers' 350-0-350, 80 mA., 6.3 v. 3 a., 5 v. 2 a. Half abraded, drop-through, 14/6 only, plus 1/6 P. & P. 110/210/240 v. Input. 350-0-350, 120 mA., 6.3 v. 6 a., 6.3 v. 1.5 a., 5 v. 3 a. Tropicalised drop-through type, 21/- only, plus 2/6 P. & P. 110/210/240 v. Input, 250-0-250 120 mA., 6.3 v. 4 a., 5 v. 2 a. Upright mounting, 21/- plus 2/6 P. & P. 250 v. Input, 350-0-350 80 mA., 6.3 v. 3 a., 4 v. 2 a. Tropicalised drop-through type, 9/6 only, plus 1/6 P. & P. Input 110/230 v. Auto load 230 v. 750 mA. 350-0-350 130 mA. Tapped filament winding 6 v. 3 a., 15 v. 3 a., 21.5 v. .6 a., also 5 v. 2 a. Tropicalised drop-through type, 21/- plus 2/6 P. & P. 270-0-270, 100 mA. 6.3 v. 3 a., 5 v. 2 a., 200/250 v. Input universal mounting 16/6, plus 1/6 P. & P.

THE R.E.P. ONE-VALVE BATTERY RECEIVER KIT. Simple one-valve all dry battery receiver for headphones, easily built in one evening. All required components including headphones, can be supplied at inclusive cost of 42/- plus 2/- P. & P. Operated by Ever Ready B114 type battery available at 7/6. Full assembly details available separately at 9d. plus 3d. post.

THE R.C. RAMBLER ALL-DRY PORTABLE KIT

Full assembly details with practical and theoretical diagrams can be supplied at 1/6 post free. This is a truly professional 4-valve superhet—all dry—for medium and long waves. A cream plastic top panel, with dial engraved in red and green, adds to the very imposing appearance of this model which is housed in an attractive cream and grey leatherette covered attaché-case type cabinet measuring only 9in. x 7in. x 3½ in. Weight less batteries 4½ lb., with batteries 6½ lb. This set really has everything! Built-in frame aerial, high quality, extremely sensitive, and very adequate volume from the 5in. speaker. Valve line-up: 3V4, 1R5, 1S5, 1T4. Also the required components, exactly as specified, including cabinet, can be supplied from stock at the special inclusive price of 42/7- plus 2/- P. & P. (less batteries). Uses Ever-Ready 90 v. H.T. type B126 at 8/3. Also L.T. 1.5 v. A.D. 35 at 1/4.

RAMBLER MAINS UNIT!—At last we are able to offer our special mains unit kit for using our popular all-dry " Rambler " on A.C. Mains. Complete kit, which when assembled fits snugly into battery compartment, can be supplied at 47/6, plus 1/6 packing and postage. Price includes all required components, and full assembly instructions. M.B.—This unit is completely self-contained in a metal box measuring 7in. x 2½ in. x 1½ in. and is ideally suitable for ANY all-dry R.C. Rambler portable requiring 90 v. H.T. and 1.5 v. L.T.

F.M. KITS! Complete kit available for "DENCO" F.M. Tuner. Price including all complete kit and valve for extra 1.P. stage 58/7/6, plus 2/6 P. & P. Constructional details and itemised price list 1/6 post free.

"JASON" F.M. TUNER KIT. Our latest based on booklet by Data Publications. Booklet and itemised price list 2/- post free. Complete kit price, which includes attractive front panel and calibrated dial and drive 48/15/-, plus 2/6 P. & P. Pringe area model 47/15/-, plus 2/6 P. & P. N.B.—Both of these tuners are being demonstrated at 18, Tottenham Court Road.

THE "TELETRON" BAND III CONVERTER !!

This converter, which is built around 2 valves type EP50 (2710) is for use with T.R.F. or Superhet Band 1 Television receivers. Complete set of TELETRON coils only, with practical and theoretical wiring diagram 15/- post free. (Chassis measuring 7in. x 3in. x 1½ in. ready drilled to specification 3/9 plus 5d. P. & P. Alternatively, construction details only with separate individually priced parts list 8d. post paid. THE COMPLETE KIT AS SPECIFIED INCLUDING ALL THE ABOVE VALVES, ETC. DOWN TO THE LAST NUT AND BOLT. CAN BE SUPPLIED AT 48/6 only, plus 2/- P. & P.

VALVES!!

We have perhaps the most comprehensive and up-to-date valve stocks in the trade. A stamp will bring list.

● Please add postage under £1. C.O.D. or Cash with order. C.O.D. charge extra—open 9 a.m.—6 p.m. Monday to Friday. Sorry, but we close at 1 p.m. on Saturday.

RECEIVERS & COMPONENTS

MAKING YOUR OWN? Telescopes, Enlargers, Binoculars, Microscopes, Projectors, or, in fact, anything that needs lenses. Then get our booklets. "How to use Ex-Gov. Lenses & Prisms," Nos. 1 & 2, price 2/6 each; also our stereo book "3-D Without Viewers," price 7/6. Comprehensive lists of lenses, optical, radio and scientific gear, free for s.a.e. H. W. ENGLISH, Rayleigh Road, Hutton, Brentwood, Essex.

RADIOGRAM CHASSIS, 29/9, including 8in. speaker, 5-valve s/het. 3 w/band A.C. mains, complete less valves, tested, guaranteed; free drawing with order; post 4/6; set of knobs 1/6 extra. Radiogram Chassis, 14/9, A.C. or universal s/het. 3 band, 465. I.F.s, less dial, electrolytics and valves, otherwise believed to be in working order; post 3/6. **DUKE & CO.**, 621, Romford Rd., E.12. (GRA 6677.)

AMERICAN RADIO Plans and Devices. Now available. Hundreds of new and startling devices you can make. Only designs of this type available in UK. Receivers, walkie talkies, amplifiers, recorders, magic eye alarms, etc., etc. Full lists, data illustrations free of stamp. Send to-day—A.P.S. (PW), Sedgeford, King's Lynn.

OSMOR for really efficient Coils, Coilpacks and all Radio Components as specified for many "Practical Wireless" circuits. See advert. on page 607 for free circuits offer or send 5d. (stamps) to **OSMOR RADIO PRODUCTS LTD.** (Dept. PC10, P607), 418, Brighton Road, South Croydon. (Tel.: Croydon 5148/9.)

THE HIWAYMAN. A new super Portable Radio for the home constructor; all-dry 4-valve superhet with Ferrite rod aerial; easy wiring diagrams and instructions, 1/6 (post 3d.). **RADIO EXPERIMENTAL PRODUCTS LTD.**, 33, Much Park St., Coventry.

MIDDLESBROUGH. Largest stocks on N.-East coast. Radio/TV components. FM Kits, Gram. Cabinets, Tape Decks, Leak Amplifiers, Valves, etc. Callers only. **PALMERS**, 106, Newport Road (Phone: 3096.)

ALUMINIUM CHASSIS made to your requirements; 16 & 18 gauge; any quantity, large or small. We will be pleased to quote. **MACHINE CONTACTS**, Building 336, Hurn Airport, Christchurch, Hants.

R.F. UNITS, Types 26 at 27/6, 25 at 12/6, 24 at 11/-; brand new with valves; post 2/6. **E.W.S. CO.**, 69, Church Road, Moseley, Birmingham.

SERVICE SHEETS, T.V. and Radio, over 2,000 models, sale or hire; Valves and Components. S.A.E. with enquiries. **W. J. GILBERT**, 24, Frithville Gardens, London, W.12.

LOUDSPEAKERS repaired promptly. **MODEL LOUDSPEAKER SERVICE**, Bullingdon Rd., Oxford.

HRO RACK MOUNTING; Collins TCS-10 25 watt Trans/Receiver, mobile; Avo Testmeter; Taylor 60-Signal Generator; Taylor 45A Valve Tester; Morse Teacher with tapes; 1132A and 1481 Receivers; Type 3 Power Unit, Condensers, Resistors, etc. Low price to clear surplus gear. List free. **THE ELECTRIC METER COMPANY**, 123, Hele Road, Torquay.

RATEL OF PRESTON. Service Sheets and Components for radio and television. S.A.E. enquiries, please. 171, Norris St., Preston, Lancs.

SERVICE SHEETS, Radio, T.V. etc., from 2/3 p.d. List of 4,000 models avail., 1/-. **TELRAY**, 11, Maudland Bk., Preston.

RATES: 5/6 per line or part thereof, average five words to line, minimum 2 lines, Box No. 1, extra. Advertisements must be prepaid and addressed to Advertisement Manager, "Practical Wireless," Tower House, Southampton St., Strand, London, W.C.2.

ELECTROLYTICS, capacity, voltage, size, type of mounting, price, post paid. 400, 6V, 1in. x 2in., lug, 1/6; 250, 6V, 1in. x 2in., lug, 1/6; 1,000 + 2,000, 6V, 1 x 3, clip, 3/6; 250, 12V, 1 x 1 1/2, clip, 1/9; 500, 12V, 1 x 1 1/2, W/E, 2/-; 10, 25V, 1 x 1 1/2, clip, 1/3; 25, 25V, 1 x 1 1/2, W/E, 1/6; 500, 50V, 1 x 3, clip, 3/6; 100, 50V, 1 x 1 1/2, W/E, 2/3; 50 + 50, 150V, 1 x 2, clip, 2/9; 40 + 40, 275V, 1 x 2, clip, 3/3; 100, 275/350V, 1 x 3, clip, 3/3; 24, 275V, 1 x 2, clip, 3/3; 50, 275, 375V, 1 x 4 1/2, clip, 6/3; 32, 375, 375V, 1 x 3, W/E, 3/3; 24, 275V, 3/2, clip, 3/3; 16 + 16 + 8, 350/425, lug, 4/3; 32 + 32, 350/425V, clip, 1 1/2 x 2, 4/3; 16 + 16, 350/425V, clip, 1 1/2 x 2, 2, clip, 3/9; 8 + 8, 350V, 1 x 2, clip, 3/3; 16 + 32, 350V, 1 1/2 x 2, clip, 3/9; 8, 450V, 1 x 2, clip, 1/9; 15 + 15, 450V, 20, 25V, 1 x 3, lug, 4/3; 60 + 120, 275V, 1 1/2 x 4 1/2, clip, 5/6; 20 + 10, 450V, 1 x 3, clip, 4/3; 16 + 16, 450V, 1 x 2, clip, 4/3; 100 + 200, 350/425V, 2 x 4 1/2, clip, 6/9; 8, 500V, 1 1/2 x 2 1/2, clip, 2/6; 8, 8, 500V, 1 1/2 x 2, clip, 4/-; all All Cans, some with sleeves, all voltages, w/g., surge where marked, new stock, guaranteed. Television Chassis, cadmium plated, steel, size 14 x 13 x 2 1/2in., complete with 13 valveholders (0-B9A Pax., 1-B9A Cer., 2-B7G Cer., 1-Int. Oct. Ampl.), 20 various tag strips, cut away for metal rec. line trans., etc., 9/11 each, post paid; front and rear tube mounts to fit above chassis, 3/- pair, post paid. P.M. focus Magnets, wide angle, tetrode tube, fully adjustable, 12/-, post paid. Scanning Coils, wide angle, with mounting lugs, 19/6, post paid. Line Trans. to match these coils, gives 12Kv. E.H.T., complete with width and line linearity coils, 19/6, post paid. Malns Trans., P.R.I. 0-210-240, SEC., 250-0-250V, 8ma, 6.3v, 2.5a; 6.3v, 0.6a, 12-. **RADIO CLEARANCE LIMITED**, 27, Tottenham Court Road, London, W.1. (Telephone: Museum 9188.)

RADIO UNLIMITED offer, 12in. P.M. speakers 27/6, post 1/6. Amplifiers, 3-stage, AC or AC/DC. Kit, incl. valves, 59/6. Wired/tested 75/-, 5-Valve push-pull model, AC mains. Kit, incl. valves, 130/-. Wired/tested 150/-. T.r.f. receiver. Kit, incl. cabinet, valves, circuit, 92/6. Bat/port kit, incl. carrying case, valves, circuit, 102/-. T/v converter kit, incl. chassis, valves, coils, 52/6. Diode X/tal. receiver 10/6. Clear-ance, O/stocked valves. List free. **RADIO UNLIMITED**, Elm Road, London, E.17, also at 50, Hoe Street, E.17. (Tel.: LARKSWOOD 6377.)

F.M. HI-FI. New A2 Receiver, £8, BEL, Marlborough Yard, N.19. (AR 5078.)

VALVES

VALVES, new, tested and guaranteed. Matched pairs, 6V6G and 6X4. 17/- per pair; E92, W7T, 4/6; E91, 6AL5, 6/6; 6F12, E91, 6AM6, 6V6G, 6V6GT, 5763, 7/6; 6BE6, 6BW6, 6K8G, 6SL7GT, 6SN7GT, 6X4, 6X5GT, 8/-; 5U4G, 12AX7, 12AT7, EBC41, UL41, UY41, X65, 8/6; PL82, PY82, 10/6; ECH42, UCH42, EF80, EF85, 11/6; ECL80, EY51, 12/6. Coax Cable, 75 ohm, 4in., stranded, 7d. yd.; p. and p. 6d. **R. J. COOPER**, 32, South End, Croydon, Surrey. (CRO 9186.)

VALVES WANTED, all types. State quantity, condition and price. **HERMES RADIO**, Glazebury, Manchester.

WANTED, Valves, EY51, ECL80, KT61, 6U4GT, PL81, 3524, etc., etc., prompt cash. **WM. CARVIS LTD.**, 103, North Street, Leeds, 7.

ALL TYPES of Valves required for cash. State quantity and condition. **RADIO FACILITIES LTD.**, 38, Chalcot Road, N.W.1. (PRImrose 9090.)

SITUATIONS VACANT

The engagement of persons answering these advertisements must be made through a Local Office of the Ministry of Labour or a Scheduled Employment Agency if the applicant is a man aged 18-64, inclusive, or a woman aged 18-39, inclusive, unless he or she, or the employment, is exempt from the provisions of the Notification of Vacancies Order, 1952.

RADIO INSPECTOR required to cover the overhaul and testing of modern aircraft Radio and Radar equipment. The post is both permanent and pensionable. Free transport to local towns. Canteen facilities. Write stating starting experience and qualifications. **AIRTECH LIMITED**, Aylesbury & Thame Airport, Haddenham, Bucks. (Telephone: Aylesbury 1163.)

REQUIRED to fill immediate vacancies—Radar Mechanics with experience of Army A.A. Mark 3 for employment as Testers. **AIRTECH LIMITED**, Aylesbury & Thame Airport, Haddenham, Bucks. (Telephone: Aylesbury 1163.)

TESTERS REQUIRED for Radio Production Line. Apply in writing giving details of experience and rate required to Personnel Manager, **McMICHAEL RADIO LTD.**, Wexham Road, Slough, Bucks.

DENCO (CLACTON) LIMITED, due to expansion, require the services of an Engineer able to design coils and coil packs in keeping with modern technical requirements. Permanent employment and participation in pension scheme is offered to a first-class designer. 357/9, Old Road, Clacton-on-Sea, Essex.

DENCO (CLACTON) LIMITED, due to expansion, require the services of a Foreman skilled in setting Douglas Wave and other Coil Winders and the intelligent control of labour. Permanent and pensionable employment is offered to a man between the ages of 25 and 50 years. 357/9, Old Road, Clacton-on-Sea, Essex.

TELEVISION ENGINEER required; must be experienced; permanency; good pay; pension scheme. **KING & HARPER LTD.**, Bridge Street, Cambridge.

T.V. AND RADIO—A.M. Brit. I.R.E., City and Guilds, R.T.E.B. Cert., etc., on "no pass—no fee" terms. Over 95% successes. Details of exams. and home training courses in all branches of radio and T/V; write for 144-page handbook—free. **B.I.E.T.** (Dept. 242G), 29, Wright's Lane, London, W.8.

A.M.I. Mech. E., A.M. Brit. I.R.E., City and Guilds, etc., on "no pass—no fee" terms; over 95% successes. For details of exams and courses in all branches of engineering, building, etc., write for 144-page handbook, free. **B.I.E.T.** (Dept. 242B), 29, Wright's Lane, London, W.8.

WANTED

WANTED, Output Meter, Signal Generators, Valve Testers, of American type and Capacitance Bridges. **R. GILFILLAN & CO. LTD.**, 7, High Street, Worthing, Sussex. (Telephone: Worthing 8719.)

BACK NUMBERS "Practical Wireless," Feb. '51, May '46, May '45 and June to Nov., 1941, inclusive. PEESEY, 93, Grand Drive, London, S.W.20.

WANTED, ex-Govt. KTZ41 and VT61A Valves. Advise quantity and condition. Prompt cash. RADIO SUPPLY CO. (LEEDS) LTD., 32, The Calls, Leeds, 2.

PROMPT CASH offered for your surplus brand new Valves, Loudspeakers, Components, etc. Send list and prices to R.H.S. LTD., 155, Swan Arcade, Bradford, 1.

EDUCATIONAL

BUILD YOUR OWN TV and learn about its operation, maintenance and servicing. Qualified engineer-tutor available whilst you are learning and building. Free Brochure from E.M.I. INSTITUTES, Dept. P.W.58, London, W.4. (Associated with H.M.V.)

VALVES

SAME DAY SERVICE

All Guaranteed New and Boxed

Table listing various vacuum tube types and their prices, including 1.4v. midget, 1R5, 1S5, 1T4, 3S4, 3V4, DAF91, DF91, DR91, DL92, 7/3, any 4 for 26/6, 1A7GT, 6LD20, 9/8/80, 8/6, EL41 11/6, 6P25 14/8, A231 10/6, EL191 5/6, 1C5GT 11/6, 6P25 19/6, CL33 12/6, PY31 12/6, 1D5 11/6, 6SN7GT 9/-, D1 3/6, EZ40 8/6, 1H5GT 11/6, 6U4GT 8/6, DCC9010/6, MU14 8/6, 1N5GT 11/6, 6V6GT 7/6, DF33 11/6, N78 14/6, 1R5 7/3, 6V8GT 7/6, DH7 8/6, F81 12/6, 1S5 7/3, 6X4 7/6, DK92 7/6, PCC84 10/-, 1T4 7/3, 6X5GT 6/9, DL33 11/6, PEN46 8/6, 3A5 10/6, 7B7 8/6, DL35 11/6, PL33 11/6, 3Q5GT 7/6, 7C5 8/6, EB91 6/6, PL81 11/6, 3S4 11/6, 7H7 7/6, EBC41 10/-, PL83 12/6, 3V4 7/6, 7S7 8/6, EBF80 PY90 9/6, 5U4G 8/6, 7Y4 8/6, 10/6, PY81 10/6, 5Y3GT 7/9, 10C1 12/6, ECC40 15/6, PY32 7/9, 5Z4G 9/-, 10F1 10/-, ECC81 9/-, PZ30 17/-, 6AL5 6/3, 10P13 10/-, ECC83 T41 13/6, 6AM5 5/-, 10P14 12/6, 10/6, U24 17/6, 6AM6 6/3, 12A17 9/-, ECC91 7/-, U25 12/-, 6AT6 8/6, 12AU7 9/-, ECH35 U50 7/6, 6BA6 7/6, 12X7GT 11/9, U78 8/6, 6BE6 6/6, 10/6, ECH42 10/-, U281 10/-, 6BW6 7/6, 12K7GT ECH81 10/-, U404 9/-, 6BW7 7/6, ECF80 9/6, UBC41 9/-, 6C4 7/6, 12K8GT EFL70 11/6, UBF80 10/6, 6F1 13/6, 12Q7GT EF39 6/6, UCH42 9/6, 6FG6 7/6, 9/6, EF40 17/6, U41 8/6, 6F14 12/-, 12Z3 7/6, EF41 8/6, UF42 13/6, 8J5 7/6, 20F2 11/6, EF42 17/6, U41 9/6, 6JG7 6/6, 12J7GT EF50 7/6, U6 10/9, 6K7G 6/-, 20P1 15/-, EF80 10/-, U08 17/-, 6K7GT 6/-, 25Z4G 9/-, EF86 17/6, UY41 9/-, 6K8G 8/6, 35L8GT 8/6, EF91 6/3, W77 5/6, 6K9GT 9/-, 35Z4GT 8/6, EF92 5/-, Y83 7/6, 8K25 11/9, 35GT 8/6, EF95 10/8, Z83 18/6, 6L6G 9/6, 50L8GT 8/6, EL38 22/8, Z77 6/3, Postage 4d. per valve extra.

READERS RADIO 24, COLBERG PLACE, STAMFORD HILL, LONDON, N.16. STA: 4587

1-Finger Pianists

Build your own electronic keyboard and play everything! Send for free leaflet. Guitar, cello, flute and trumpet are all easy. Write now...

C & S, 10 Duke St., Darlington, Co. Durham

MORSE CODE Training Send for the Candler BOOK OF FACTS

It gives details of all Courses which include a Special one for acquiring amateur licence. CANDLER SYSTEM CO. Dept. 5LC, 52b, Abingdon Road, London, W.8. Candler System Co., Denver, Colorado, U.S.A.

FREE! Brochure giving details of Home Study Training in Radio, Television, and all branches of Electronics. Courses for the Hobby Enthusiast or for those aiming at the A.M.Brit.I.R.E. City and Guilds, R.T.E.B. and other Professional examinations. Train with the college operated by Britain's largest Electronics organisation; moderate fees. Write to E.M.I. INSTITUTES, Dept. P.W.28, London, W.4.

MERCHANT NAVY. Train as Radio Officer. The big liners are open to you, but you must qualify for the P.M.G. Certificate Day, Evening and "Radiocerts" Postal Courses. Est. 36 years. S.A.E. for prospectus from Director, THE WIRELESS SCHOOL, 21, Manor Gardens, London, N.7.

WIRELESS.—Day and Evening Class instruction for P.M.G. Certificate of Proficiency and Amateur Wireless Licence. Morse instruction only if required, also post-course. Apply B.S.T. LTD., 179, Clapham Rd., London, S.W.9.

WIRELESS. See the World as a Radio Officer in the Merchant Navy; short training period; low fees; scholarships, etc., available. Boarding and Day students. Stamp for prospectus WIRELESS COLLEGE, Colwyn Bay.

CITY AND GUILDS (Electrical, etc.) on "no pass—no fee" terms. Over 95% successes. For full details of modern courses in all branches of Electrical Technology send for our 144-page handbook—free and post free. B.I.E.T. (Dept. 242A), 29, Wright's Lane, London, W.8.

MERCHANT NAVY Wireless School. Overseas House, Brooks' Bar, M/cr 16.

STAN WILLETTS 43, Spon Lane, West Bromwich, Staffs.

"VALVES." BRAND NEW, GUARANTEED. PCL83, PCF80, PCC84, ECL80, 10F1, 9/9 each; 12BE6, EF54, Z77 (6AM6-12AX7), 6/36 each; 2T11, EL81, NT 5/- each; 5U4G, EBC33, 6SN7, 6SL7, 6K8G, PEN46, EAC90, R10, R17, 7/6 each; EA50, 4D1, 8D2, 12H6, 1/9 each; 6V6GT, 6/-; 6X5GT, 6X4, 6/9; ATP4, 3/6; V570, 3/6; 12AT7, 12AU7, 6/9; 7-7, each; 9D2, 8/3; EF80, 8/6; EY51, 11/6; ECS2, 3/6; U25, 11/6; 723A/B, 45/-; SP1, 2/-; RM2, 3/9; RM3, 5/-; RM4, 14/-; 1T4, 1R5, 1S5, DL94, 26/6 set of 4, P. & P. 6d.

TRIPLE T MIA METAL RECTIFIERS, brand new, with circuit, 5/6. P. & P. 6d. GERMANIUM CRYSTAL DIODES, G.E.C., 1/- each, 9/6 doz. P. & P. 3d. PACKARD-BELL PRE-AMPLIFIER, brand new, with 2 valves 6SL7, 20D7, and circuit, 12/6. P. & P. 1/-.

24V. VIBRATOR PACK (Complete) with 12-volt vibrator, transformers, chokes, two metal rectifiers (230v, 60 ma), 12/6. P. & P. 2/6.

TELEKIT SUPPLY

MAIL ORDER DEPT. Chantry Lane, Bromley, Kent. Please mention P.W. and enclose 6d. postage.

Table listing various electronic components and their prices, including valves, resistors, capacitors, and diodes.

COMPONENTS FOR F.M. RADIO, T.V., RADIO CONTROL, ETC., AVAILABLE AT 104, HIGH ST., BECKENHAM, KENT BEC 3720

THE INSTITUTE of Practical Radio Engineers Home Study Courses are suitable coaching text for I.P.R.E. and other qualifying examinations. Fees are moderate. Syllabus of seven modern courses post free from SECRETARY, I.P.R.E., 20, Fairfield Road, London, N.8.

BOOKS

I.P.R.E. TECHNICAL PUBLICATIONS. 6,500 Alignment Peaks for Superheterodynes, 5/9, post free. Data for constructing TV Aerial Strength Meter, 7/6. Sample copy, The Practical Radio Engineer, quarterly publication of the Institute, 2/-; membership and examination data, 1/-; Secretary, I.P.R.E., 20, Fairfield Rd., London, N.8.

AMERICAN MAGAZINES.—One-year "Audio Engineering," 35/-, specimen copy, 3/6; "Popular Science," 43/-; "High Fidelity," 50/-; specimen copy, 4/6. Free booklet quoting others. WILLEN LTD., Dept. 40, 101, Fleet Street, London, E.C.4.

DIPLOMA HEADPHONES Kenroy Ltd. Lightweight High Resistance 2x2000 ohms. Complete with cord. 16/9 Suitable for use with crystal receivers. KENROY LTD. 152/297 Upper St., LONDON, N.1. CAV 4905/1603.

ASTRAL RADIO PRODUCTS

'HOME RADIO', 32 page illustrated booklet. Simple wiring instructions for Crystal Set, 1, 2, 3 Valves, 2/-, post 3d. TRF COILS, Specified for 'Redside Push-button 4', All Dry 3 Band, 3', 'Push-button 4', etc., 6/6 pr., post 6d. Push-button Unit with modification data 7/-. DUAL WAVE HF Coil, Specified for 'Summer All Dry Portable, Modern I Valver', Modern 2 Valver, 'H 7 G Battery Miniature', etc., 4/3, post 3d. IFT'S Miniature, 1" x 1 1/2" x 2 1/2" round in cans. Extra high 'Q', Spectral offer, 8/6 pr., post 6d. K COILS, 'AC' B pass 3', 3/3 each, post 6d. P.I.A.M.E. AERIALS, M.W., 5/-, post 4d. H.F. Choke (Osmor Q.C.1.) 4/-, post 4d. Crystal Set Coils, L. & M.W., 2/6, post 3d. 82, Centurion Road, Brighton

ANNAKIN

Control No. 227 with 7.5K and 20K carb. pots, 2 knobs, 2 SPDT toggles, etc., new. 2/- ea. Post 1/3. Magnetic Mikes 2/-, 8 mfd 375v. electros 1/-, Dial lamp holders, 1 mfd 400v. blocks, Rubber earcops, potm. stand-offs, 24t. ea. 50pf, 60pf mica, new 3d., 60 pf, 150 pf, 430 pf sil. mica, new 2d. Wedge lamps 12v. 6d. Wedge lampholders 3d. Dewar Keys 6d. Please send plenty of postage, surplus refunded. Money Back Guarantee. C.W.O. only. Free Lists, 25, ASHFIELD PLACE, OTLEY, YORKS

VALVES

4/- — EF50 — 4/-

SP41	2/6	1R5	7/6
EF54	5/-	EF50 (Syl)	
EF37A	11/-		6/3
6V6	8/6	105/30	5/6
6K7	6/-	VU133	3/-
6SK7	4/-	CV201	7/6
6SH6	5/-	VT501	6/-
5Z4	8/6	Pen 220	4/-
1T4	7/-	EA50	2/-
2X2	4/-	EC52	5/-
12H6	4/-	EF39	7/-
VU111	3/-	6K8	11/-
CV63	6/-	6L5	5/-
CV286	7/-	6SA7	9/-
EL32	5/-	6SN7	9/-
SP61	2/6	VU39	8/6
EF36	3/6	1S5	7/6
EC54	4/6	12SH7	4/-
6Q7	8/6	150/30	7/6
6J7	7/-	RK34	2/6
6SJ7	6/-	CV286	7/-
6SL7	7/-	EL50	9/-
5U4G	8/6	HL2	4/-

GERMANIUM DIODE.—G.E.C., at 2/- each.

SILICON DIODE.—U.S.A. at 2/6 each. Packard Bell Amplifier, 1 6SL7, 1 28D7, valves and booklet, 12/- New. Siemen H/S Relay, 3,400 ohms, at 10/-.

VINERS

(MIDDLESBROUGH)

26, EAST STREET, MIDDLESBROUGH

(Tel. : Mid 3418)

DST100 COMMUNICATIONS SET.—Covers 50 kc/s-30 Mc/s, 7 bands, 5-stage R.F., turret coils, double superhet. The receiver £25 U.K. Few only.

BENDIX TX.—TA, 12G. Brand New. Covers 300 kc/s-600 kc/s and 3 Mc/s-4.8 Mc/s, 4 Mc/s-6.4 Mc/s, 6 Mc/s-9 Mc/s in 4 Channels. Valve line up: three 807, four 12SK7. £6 (Mainland).

T1403 TX in Brand New Condition. Cabinet worth money to make Table Topper. Less valves, £3/10/- (Mainland).

TR9 RX.—Six-valve Battery Set. 120 volt H.T., 2 volt Filament, 15/- A Bargain, New.

AMPLIFIER TYPE 1553A.—Complete (new) with 2 valves, 2 volt Filament, less batteries, £1.

POWER PACK.—350-350 volt 150 mA., 6.3 v. 5 amp., 5 v. 3 amp. input, 230-250 A.C. mains. Smoothed with choke.

A Bargain at £2/10/- each.

RELAYS.—All types in stock from 2/6 each.

RF 24 & 25.—Less valves, 10/- RF 27, £1.

CONDENSERS.—Electrolytic, 8 mfd., 2/-; 8+8 mfd., 3/9; 16+8, 4/-; 16+16. 4/6. All 450 v. wkg. 20 mfd., 3/-; 32 mfd., 500 v. wkg. Bias 25 v./25 mfd., 2/-; 50/50, 2/-.

RESISTORS (Carbon).— $\frac{1}{2}$, 1, 2 watt mixed. 12/6 per 100.

POTENTIOMETERS. All values at 2/6 each.

CONDENSERS.—5 pF-1 mfd., £1 per 100. Mixed.

METERS.—M.C. T.C., etc. £1 for 8.

SWITCHES.—Yaxley, Toggle and Rotary types at 9/- per dozen. Mixed.

TRANSFORMERS.—200-250, A.C. mains input; output 5 v., 11 v., 17 v., 1½ amp., 13/6; 4 amp., £1. Auto Trans., 110, 150, 190, 230 v. 7 amp., £2.

COPPER WIRE

COTTON COVERED

SILK COVERED

S.W.G.	2 ozs.	4 ozs.	2 ozs.	4 ozs.
16	1/6	2/3	1/6	2/3
17	1/6	2/4	1/6	2/4
18	1/6	2/5	1/6	2/5
19	1/7	2/6	1/8	2/8
20	1/7	2/7	1/9	2/11
21	1/7	2/8	1/10	3/1
22	1/8	2/9	1/11	3/3
23	1/9	2/10	1/12	3/5
24	1/9	2/11	2/-	3/5
25	1/10	3/-	2/1	3/7
26	1/11	3/2	2/2	3/9
27	2/-	3/4	2/3	3/11
28	2/-	3/5	2/4	4/1
29	2/1	3/7	2/5	4/3
30	2/2	3/9	2/6	4/5
31	2/3	3/10	2/7	4/7
32	2/3	3/11	2/9	4/11
33	2/5	4/2	3/-	5/5
34	2/6	4/5	3/1	5/7
35	2/8	4/8	3/3	5/11
36	2/9	4/11	3/5	6/3
37	3/2	5/9	3/7	6/7
38	3/6	6/5	3/9	6/11
39	4/3	7/9	4/-	7/5
40	4/8	8/3	4/3	7/11

POSTAGE EXTRA.

POST ORDERS ONLY PLEASE. Send stamp for comprehensive lists.

CRYSTAL SET

INCORPORATING THE SILICON

CRYSTAL VALVE

Adjustable Iron Cored Coil.

RECEPTION GUARANTEED

Polished wood cabinet, 15/-, post 1/-

A REAL CRYSTAL SET. NOT A TOY

POST RADIO SUPPLIES

33 Bourne Gardens, London, E.4

FIRST-CLASS

RADIO COURSES . . .

GET A CERTIFICATE!

QUALIFY AT HOME—IN SPARE TIME

After brief, intensely interesting study—undertaken at home in your spare time—YOU can secure your professional qualification. Prepare for YOUR share in the post-war boom in Radio. Let us show you how!

FREE GUIDE

The New Free Guide contains 132 pages of information of the greatest importance to those seeking such success-bringing qualifications as A.M.Brit.I.R.E., City and Guilds Final Radio, P.M.C. Radio Amateurs, Exams, Gen. Cert. of Educ., London B.Sc. (Eng.), A.M.I.P.E., A.M.I.Mech.E., Draughtsmanship (all branches), etc., together with particulars of our remarkable Guarantee of

SUCCESS OR NO FEE

Write now for your copy of this invaluable publication. It may well prove to be the turning point in your career.

FOUNDED 1885—OVER

150,000 SUCCESSSES

NATIONAL INSTITUTE OF ENGINEERING

(Dept. 461), 148, HOLBORN, LONDON, E.C.1

BENSON'S BETTER BARGAINS

BRAND NEW. ORIGINAL CARTONS. R.F. UNITS. TYPES 26 or 27, 27/8: 24, 15/- (Postage 2/6). TR125, 801cd, 12 6. RK181, 160/220 mc/s with 2/EF54, 1/BC52, 1/CV66, new, 17/8; I.F. AMPLIFIER 178 (for this) 16.5 mc/s. with valves, 22/8 (post 2/- each). R1355 Coil-pack, new, 12/8; used, 9/8. I.F. Filters 2/8. Condensers tub. 3 v. 3 mfd., 1/- AERIAL RELAYS (oo-axial) c/o 12/24 v., 7/8. DYNAMOTORS, D.C. (approx. 250 v. 80 mA., at 6 v.) 9/- 12 v. Input, 250 v. 80 mA. and 4½ v. output, P.M. field, 7/8. EDDYSTONE 12 v. to 190 v. 75 mA. cased, 15/-; 11 v. to 300 v. 200 mA. cased, 16/8 (carr. 7/6). HALLICRATER 12 v. to 330 v. 165 mA., with vibrator 12 v. to 250 v. 70 mA., in one case, 50/- (carr. 7/6). Filters for these, 2/8. I.F.T.'S, new cased 10/15 Mc/s. 1 3. CLOCKWORK Contactors, 2 impulses per sec., 8/6. REMOTE Contactors, 2/8. TR1196 with all valves, less xtals, 45/- (carr. 7/6). R1355, new improved type, 37/8 (carr. 7/6). TR143A-Tx. 50, 6 valves, 17/8; Rx, 7/1. 8 valves, 27/8; Mod. amp., 7 valves, 15/- (post 2/6 each). R1382A 100/150 mc/s., 1.5 valves, used, good cond., £7 10/- (carr. 10/-).

METERS—BRAND NEW—BOXED

FSD	Scale	Size	Type	Fit	Price
500/1A	3 in.	MC	Pr.Rd.	25	
2mA	2 in.	MC	Pr.Rd.	10 6	
10mA	3 in.	MC	Pr.Rd.	7	
10mA	4 in.	MC	Pr.Rd.	20	
20mA	3 in.	MC	Pr.Rd.	7	
25mA	3 in.	MC	Pr.Rd.	7	
30mA	2 in.	MC	Pr.Rd.	6	
40 & 120mA	2 in.	MC	Pr.Rd.	7 8	
100mA	3 in.	MC	Pr.Rd.	5	
100mA	3 in.	MC	Pr.Rd.	7	
200mA	2 in.	MC	Pr.Rd.	6	
200mA	3 in.	MC	Pr.Rd.	7	
250mA	3 in.	MC	Pr.Rd.	7	
500mA	3 in.	MC	Pr.Rd.	7	
1A	2 1/2 in.	TO	Pr.Rd.	7	

List and enquiries: S.A.B. please! Terms: Cash with order. Postage extra. Immediate despatch.

Callers and Post
W. A. BENSON (PW)
308 Rathbone Rd.,
Liverpool, 13.
STO 1804.

Callers
S U P E R A D I O
(Wholesale) LTD., 118
Whiteapel, Liver-
pool 1. ROY 1130.

SOUTHERN RADIO'S WIRELESS BARGAINS

TRANSRECEIVERS. Type "38" (Walkie-Talkie). Complete with 5 Valves. In Metal Carrying Case. Ready for use. Less external attachments, 30/- per set. ATTACHMENTS for use with "38" TRANSRECEIVER: HEADPHONES, 15/6; THROAT MICROPHONE with Lead & Plug, 4/6; JUNCTION BOX, 2/6; AERIAL, 2/6; SPECIAL OFFER of used "38" TRANSRECEIVERS less valves but complete with ALL COMPONENTS. Excellent for SPARES, 11/6 per set. P. & P. 2/-.

TRANSCEIVERS. Type "18" Mark III. TWO UNITS (Receiver & Sender) contained in Metal Case. Complete with Six Valves, Microammeter, etc. LESS EXTERNAL ATTACHMENTS, £4/10/-.

RECEIVERS. Type "109", 8-Valve S.W. Receiver with VIBRATOR PACK for 6 Volts. Built-in Speaker, METAL CASE, £5.

BOMBSIGHT COMPUTERS. Ex-R.A.F. BRAND NEW. A Wealth of Components. GYRO MOTORS, REV. COUNTERS, GEAR WHEELS, etc., etc. Ideal for Model Makers, Experimenters, etc., £3.

LUBBRA HOLE CUTTERS. Adjustable 1/2 in. to 3/4 in. For Metal, Wood, Plastic, etc., 6/6.

RESISTANCES. 100 ASSORTED USEFUL VALUES. Wire Ended, 12/6 per 100.

CONDENSERS. 100 ASSORTED. Mica, Metal Tubular, etc., 15/- per 100.

PLASTIC CASES. 1 1/4 in. x 10 1/2 in. Transparent. Ideal for Maps, Display, etc., 5/6.

STAR IDENTIFIERS. Type I A-N. Covers both Hemispheres. In Case, 5/6.

CONTACTOR TIME SWITCHES. In Sound-proof Case. Clockwork Movement. 2 Impulses per sec. Thermostatic Control, 11/6.

REMOTE CONTACTORS for use with above, 7/6.

MORSE PRACTICE SET with Buzzer on Base, 6/9. Complete with Battery, 9/6. **MORSE TAPPERS**, Std. 3/6; Midget, 2/9.

METERS & AIRCRAFT INSTRUMENTS. Only need Adjustment or with broken Cases. TWELVE INSTRUMENTS, including 3 brand new Aircraft Instruments. 35/- for 12.

CRYSTAL MONITORS. Type 2. New in Transit Case. Less Valves, 8/-.

Postage or Carriage extra. Full List of RADIO BOOKS, 2/6.

SOUTHERN RADIO SUPPLY LTD.,

11, LITTLE NEWPORT ST., LONDON, W.C.2. GERrard 6653.



CR50 BRIDGE

Measures capacitance from 10 pF to 100 mF and Resistance from 1 ohm to 10 Megohms in fourteen ranges. Neon leakage test for condensers. Operates from 200/250 volt AC mains. Indication of balance is given by magic eye fed from high gain pentode. Complete with all valves and instructions. ONLY £7.18.0, plus 4/6 carr. packing. HP £3 deposit and five monthly payments of 23/-.

SIGNAL GENERATOR SG50 covers 100 kc/s to 80 Mc/s

in six bands on fundamentals (not harmonics), either unmodulated or with internal 400 cps modulation. Uses EF91 type valves and SenTerCel rectifier with double wound mains trans. In olive green metal case with carrying handle, size 9 in. x 1 3/4 in. x 4 in. Front panel of green perspex engraved white. A de Luxe generator. ONLY £8.10.0, plus 6/- carr./pack. HP £3 deposit and six monthly payments of 22/-.

SPECIAL OFFER—one month only. Both above instruments for only £16, carriage free.

Please send stamped, addressed envelope for illustrated leaflets per return post.

CALLERS ONLY—Charles Britain (Radio) Ltd., 11, Upper Saint Martin's Lane, W.C.2.

POST ORDERS, SPECIAL OFFER & H.P. to:
GRAYSHAW INSTRUMENTS
54, OVERSTONE ROAD, HARPENDEN, HERTS.

PULLIN
SERIES 100
TEST METER
AC/DC 10,000 A/V
21 RANGES
100µA to 1000V
COMPLETE IN DIE-CAST CASE WITH TEST LEADS CLIPS AND PRODS FULLY GUARANTEED

£2.10s.
DEPOSIT AND ELEVEN FURTHER MONTHLY PAYMENTS OF £1.
CASH PRICE £12.7.6.

PHONE 58927
Frith
RADIOCRAFT Ltd
69-71 CHURCH GATE LEICESTER

F M and H-I Components

- DENCO F.M. TUNER circuits 1s. 6d.
- RADIO CONST'R. F.M. " 2s. 0d.
- MULLARD AMPLIFIER " 2s. 6d.
- OSRAM 912 AMPLIFIER " 3s. 6d.

Separate price lists available on request to

J. T. FILMER MAYPOLE ESTATE, BEXLEY, KENT.

Tel. Bexleyheath 7267.

RADIO AND TELEVISION COMPONENTS

All parts in stock for:
Viewmaster, Soundmaster, Telexing, etc.
Easy Terms available.
2/d. stamp (only) for Catalogue.
JAMES H. MARTIN & CO.,
FINSTHWAITE, NEWBY BRIDGE,
ULVERSTON, LANCs.

ARE YOU SURE?

Only one in a hundred home-built receivers, amplifiers and so on give of their best. Remember, just one inaccurate component will ruin performance. Is that 1,000-ohm resistor 800 ohms or 1,200 ohms—or something in between? With 20 per cent. tolerance it could be any of those values. Our Res/Cap. Bridge, complete in every detail for only 91/6, will check every resistor and condenser quickly and accurately. Here are other items from our range of famous test gear kits, at the lowest prices in the world.
Spot Frequency Sig. Gen., 35/- Tunable I.F. Aligner, 17/6. Inductance Bridge, 42/6. Audio-Frequency Bridge, 38/6. Twin Multi-omer, 25/-.

Post and packing 1/6 on all kits.
Stamp for illustrated lists.

RADIO MAIL, Dept. L
6, Raleigh Street, Nottingham

COVENTRY RADIO

189, DUNSTABLE ROAD, LUTON, BEDS.

Phone: Luton 2677

The Quality Component Specialists offer you Kits of Parts for the following:—

	Manual
Osram "912" Amplifier	3/6
Mullard 10-watt Amplifier	2/6
The Coventry	
2-watt Amplifier	} 1/-
4-watt Amplifier	
6-watt Quality Amplifier	} 1 1/6
The Coventry A.M. Tuner Unit	
Denco F.M. Tuner Unit	1/6

Complete Component Price Lists will be supplied with each Manual. Have you had a copy of our 1954/5 60-page illustrated Component Catalogue, price 1/- plus 3d. postage?

F.M. KITS

We can supply complete kits and separate components for all the popular Home Constructor P.M. Tuner Units.

FULLY DETAILED LISTS FREE

H.P. Facilities

WATTS RADIO,

8, Apple Market, Kingston-on-Thames, Surrey.
Telephone: KINGston 4099.

Practical Wireless

BLUEPRINT SERVICE

PRACTICAL WIRELESS

*No. of
Blueprint*

CRYSTAL SETS

- 1/6d. each
- 1937 Crystal Receiver ... PW71*
- The "Junior" Crystal Set ... PW94*
- 2s. each
- Dual - Wave "Crystal Diode" ... PW95*

STRAIGHT SETS

Battery Operated

- One-valve : 2s. each**
- The "Pyramid" One-valver (HF Pen) ... PW93*
- The Modern One-valver ... PW96*
- Two-valve : 2s. each.**
- The Signet Two (D & LF) ... PW76*
- 3s. each**
- Modern Two-valver (two band receiver) ... PW98*
- Three-valve : 2s. each**
- Summit Three (HF Pen, D, Pen) ... PW37*
- The "Rapide" Straight 3 (D, 2 LF (RC & Trans)) ... PW82*
- F. J. Camm's "Sprite" Three (HF, Pen, D, Tet) ... PW87*
- 3s. each.**
- The All-dry Three ... PW97*
- Four-valve : 2s. each.**
- Fury Four Super (SG, SG, D, Pen) ... PW34C*

Mains Operated

- Two-valve : 2s. each.**
- Selectone A.C. Radiogram Two (D, Pow) ... PW19*
- Three-valve : 3s. 6d. each.**
- A.C. Band-Pass 3 ... PW99*
- Four-valve : 2s. each.**
- A.C. Fury Four (SG, SG, D, Pen) ... PW20*
- A.C. Hall-Mark (HF Pen, D, Push Pull) ... PW45*

SUPERHETS

- Battery Sets : 2s. each.**
- F. J. Camm's 2-valve Superhet ... PW52*
- Mains Operated : 3s. 6d. each.**
- "Coronet" A.C.4 ... PW100*
- AC/DC "Coronet" Four ... PW101*

*No. of
Blueprint*

SHORT-WAVE SETS

Battery Operated

- One-valve : 2s. each.**
- Simple S.W. One-valver ... PW88*
- Two-valve : 2s. each.**
- Midget Short-wave Two (D, Pen) ... PW38A*
- Three-valve : 2s. each.**
- Experimenter's Short-wave Three (SG, D, Pow) ... PW30A*
- The Prefect 3 (D, 2 LF (RC and Trans)) ... PW63*
- The Band-spread S.W. Three (HF, Pen, D, (Pen), Pen) ... PW68*

PORTABLES

- 1s. 6d.
- The "Mini-Four" All-dry (4-valve superhet) *

MISCELLANEOUS

- 2s. each.**
- S.W. Converter-Adapter (1 valve) ... PW48A*
- (2 sheets), 7s. 6d.
- The P.W. 3-speed Auto-gram ... *
- The P.W. Electronic Organ (2 sheets,) 7s. 6d. *

TELEVISION

- The Practical Television Receiver, (3 sheets), 10/6
- The "Argus" (6in. C.R. Tube), 2/6*
- The "Super-Visor" (3 Sheets), 7/6*
- The "Simplex" ... 3/-*

All the following blueprints, as well as the PRACTICAL WIRELESS numbers below 94 are pre-war designs, kept in circulation for those amateurs who wish to utilise old components which they may have in their spares box. The majority of the components for these receivers are no longer stocked by retailers.

AMATEUR WIRELESS AND WIRELESS MAGAZINE STRAIGHT SETS

Battery Operated

- One-valve : 2s.**
- B.B.C. Special One-valver ... AW387*

Mains Operated

- Two-valve : 2s. each.**
- Consoelectric Two (D, Pen), A.C. ... AW403

SPECIAL NOTE

THESE blueprints are drawn full size. The issues containing descriptions of these sets are now out of print, but an asterisk denotes that constructional details are available, free with the blueprint.

The index letters which precede the Blueprint Number indicate the periodical in which the description appears. Thus P.W. refers to PRACTICAL WIRELESS, A.W. to Amateur Wireless, W.M. to Wireless Magazine.

Send (preferably) a postal order to cover the cost of the Blueprint (stamps over 6d. unacceptable) to PRACTICAL WIRELESS, Blueprint Dept., George Newnes, Ltd., Tower House, Southampton Street, Strand, W.C.2.

*No. of
Blueprint*

SHORT-WAVE SETS

Battery Operated

- One-valve : 2s. each.**
- S.W. One-valver for American ... AW429*
- Two-valve : 2s. each.**
- Ultra-short Battery Two (SG, det Pen) ... WM402*
- Four-valve : 3s. each.**
- A.W. Short Wave World-beater (HF Pen, D, RC, Trans) ... AW436*
- Standard Four-valver**
- Short-waver (SG, D, LF, P) ... WM383*

Mains Operated

- Four-valve : 3s.**
- Standard Four-valve A.C. Short-waver (SG, D, RC, Trans) ... WM391*

MISCELLANEOUS

- Enthusiast's Power Amplifier (10 Watts) (3/-) WM387*
- Listener's 5-watt A.C. Amplifier (3/-) ... WM392*
- De Luxe Concert A.C. Electrogram (2/-) ... WM403*

QUERY COUPON

This coupon is available until October 3rd, 1955 and must accompany all Queries, sent in accord with the notice on page 641

PRACTICAL WIRELESS, Oct., 1955.

NOW AVAILABLE FROM STOCK



The smallest
COMPLETE
Tape Recorder

at only

35 gns.

Complete with
High Fidelity
Microphone
and One-Hour
spool of Tape.

PLAYTIME PLUS

by Tape Recorders (Electronics) Ltd.

EASY H.P. FACILITIES
£5.10.0 *de-*
posit and 12
monthly pay-
ments of 5/4
or any period
up to 18 mths.

Complete and ready to use with a self-contained wide range amplifier and high flux elliptical loudspeaker. Simple to operate—joystick control. Elegant 2-tone suitcase only 12½ in. x 10 in. x 5½ in., weighs less than 20 lb. A.C. mains. A completely **BRITISH MADE** Tape Recorder.

E. & G. MAIL ORDER SUPPLY CO. The Radio Centre
33 Tottenham Court Road, London W.1. Tel. MUS 6667

CONSTRUCTORS build these at

DOWN-TO-EARTH PRICES

PERSONAL PORTABLE RADIO 30/-

This little set was designed to give you a real personal portable radio that you can enjoy anywhere without disturbing others. Use it on camping trips, in bed, in your office, or just anywhere.
Send 2/- for layout, Wiring diagram and Components Price List



1v SHORT-WAVE RADIO 30/-

- ★ Covers 10-100 metres.
- ★ World-wide reception
- ★ Low drain valve.
- ★ Picture diagram and instructions for beginners.
- ★ Assembling time 1 hr.

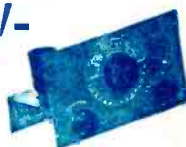

This 1 valve S.W. receiver can be built from our list of components for 30/-, including valve and 1 coil covering 20-40 metres. Provision is made to increase to 2 or 3 valves if required. All components can be purchased separately and are colour-coded so that the beginner can build this set quite easily.

Send 2/- for specification, wiring diagram, layout and price list to —

R.C.S. PRODUCTS (RADIO) LTD
11 OLIVER ROAD, LONDON, E.17. Mail order only.

MAXI-Q

REGD.

BE SURE OF SUCCESS IN RECEIVING F.M. PROGRAMMES BY BUILDING THE "MAXI-Q" F.M. FEEDER UNIT.

Full constructional details, point-to-point wiring diagram and alignment instructions are given in our Technical Bulletin DTB.8. Price 1/6. The guaranteed components described below have been acclaimed by thousands as the finest obtainable.

F.M. SCALE. A bronze finished scale with yellow markings (0-20 Log) for use with all types of F.M. Tuners or Receivers. Consisting of metal scale, pointer, cord drive spindle, pulleys, 2½ in. drum, cord, and instructions for the assembly of the cord drive. The scale measures 5½ in. x 3 in. and is for a cabinet aperture of 4 in. x 1½ in. Price 9/-.

RATIO DISCRIMINATOR TRANSFORMER. 10.7 Mc/s. Ref. RDT.1. A 10.7 Mc/s transformer for use in ratio discriminator type circuits. Can size 1½ in. square x 2½ in. high. Secondary winding of bifilar construction, iron dust core tuning, polystyrene formers and silver mica condensers. Price 12/6 each.

PHASE DISCRIMINATOR TRANSFORMER. 10.7 Mc/s. Ref. PDT.1. A miniature 10.7 Mc/s transformer for use in frequency modulation detector circuits where the limiter/Foster-Seeley type of circuit is employed. Designed for carrier deviation of ±75 KC/s. Qk=1.5. Wound on black bakelite former, complete with iron dust slugs and two 6 B.A. threaded fixing holes on .532 in. centres. Screening can 1½ in. x 13/16 in. square. Price 9/- each.

I.F. TRANSFORMER IFT 11/10.7. A miniature I.F. transformer of nominal frequency 10.7 Mc/s. The transformer is primarily intended for the I.F. stages of frequency modulation receivers and converters. The Q of each winding is 90 and the coupling critical. Construction and dimensions as PDT.1. Price 6/- each.

I.F. TRANSFORMER IFT 11/10.7 L. As IFT 11/10.7 but with secondary tap for limiter input circuits. Price 6/- each. Obtainable from all reputable stockists or in case of difficulty direct from works. **GENERAL CATALOGUE** covering technical information on full range of components, 1/- post free.

DENCO (CLACTION) LTD. 357/9 Old Road, Clacton-on-Sea, Essex

Stop Press: "OSRAM 912 PLUS AMPLIFIER." Gold finished front panel with brown control markings, 7/6. Completely punched aluminium chassis, 14/6. Pre-amplifier Chassis, 6/-.

"MULLARD F.M. TUNER COILS." I.F. Rejectors, 510/IFF, 2/6 each. Aerial Coil L1/L2, 510/AE, 4/6. Choke L3, 510/RFC, 2/- R.F. Coil L4, 510/RF, 2/6. Osc. Coil L5/L6, 510/OSC, 4/6. 1st I.F.T. L7/L8, 510/IFT1, 7/6. 2nd I.F.T. L9/L10, 510/IFT2, 7/6. Ratio Detector Transformer L11/12/13, 510/RDT, 12/6. Aluminium Chassis punched with all holes, 12/-.



PDT.1

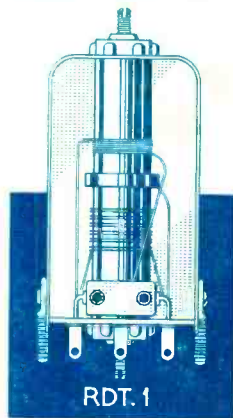

RDT.1