

Making SW Tuners

Practical Wireless, November 17th, 1934.

F. J. CAMM'S A.C. 3-VALVE SUPERHET

Practical Wireless

3^D

Published every Wednesday by
GEORGE NEWNES LTD.

Vol. 5.—No. 113.
November 17th, 1934.

Registered at the G.P.O. as a Newspaper.

AND AMATEUR TELEVISION
EDITED BY F. J. CAMM.



PETO-SCOTT 75/- DISC TELEVISION KIT

ASSEMBLED IN 30 MINUTES

NO SPECIAL TOOLS REQUIRED

PETO-SCOTT, Pioneers in Television since 1927, have, after considerable research, produced this "up-to-the-minute" Disc Television Receiver Kit, of which Efficiency and Economy are the keywords. Designed to work from almost any 3-valve battery or mains set, the Peto-Scott 75/- Disc Television Receiver is supplied in Kit form, and comprises Peto-Scott Universal Television Motor and Stand; controlling resistances; laminated and ready assembled chassis; Strobo-

scope 16in. scanning disc; Lens and lensholder; Neon Lamp and holder, together with sundry small parts. It is absolutely complete down to the last screw and piece of wire. Full-size Blueprint with assembly, wiring and operating instructions included with every kit.

Cash or O.O.D., Carriage Paid, 75/-, or yours for 10/- and 11 monthly payments of 6/6.

PETO-SCOTT CO. LTD.

77, CITY ROAD, LONDON, E.C.1.
West End Showrooms: 62 High Holborn, London, W.C.1



ADVT.



E F F I C I E N C Y
 U N I F O R M I T Y
 D E P E N D A B I L I T Y

COSSOR

SCREENED GRID VALVES

Negligible inter-electrode capacity and high mutual conductance are characteristics of Cossor Screened Grid Valves—that is why they permit exceptionally high stable amplification—why they improve the performance of any Screened Grid Receiver. Ask your dealer for the types you need for your Set.

2-VOLT SCREENED GRID VALVES

Type	Imped.	Mutual Conductance m.a./v.	Price
*215 S.G.	300,000	1.10	12/6
*220 S.G.	200,000	1.60	12/6
*220 V.S.G.	110,000	1.60	12/6
*220 V.S.	400,000	1.60	12/6

2-VOLT H.F. PENTODE VALVES

*210 V.P.T.	—	1.1	13/6
*210 S.P.T.	—	1.3	13/6

INDIRECTLY-HEATED SCREENED GRID VALVES

4 volt 1 amp. Series

*†MSG-HA	500,000	2.0	17/6
*41 MSG	400,000	2.5	17/6
*†MSG-LA	200,000	3.75	17/6
*†MVSG	200,000	2.5	17/6

* These Valves available with or without Metallised Bulbs.

INDIRECTLY-HEATED SCREENED GRID VALVES (cont'd.)

16 volt .25 amp. Series

*†DVSG	—	2.5	17/6
--------	---	-----	------

INDIRECTLY-HEATED H.F. PENTODE VALVES

4 volt 1 amp. Series

*†MS/PEN	—	2.8	17/6
*†MVS/PEN	—	2.2	17/6

16 volt .25 amp. Series

*†DS/PEN	—	2.3	17/6
*†DVS/PEN	—	2.0	17/6

.2 amp. Series

13 V.P.A.	—	1.8	17/6
13 S.P.A.	—	2.5	17/6

† Characteristics measured at —1.5 grid volts.

FREE!

A NEW
WIRELESS BOOK

A 40-page book packed with useful and interesting information—latest circuits—technical terms—how a 'super' works, etc. Send now
PLEASE USE COUPON.

To A. C. COSSOR LTD., Melody Dept., Highbury Grove, London, N.5]

Please send me free of charge, a copy of the Cossor 40-page Wireless Book.

Name

Address

PRAC. 17/11/34

B.V.34.

UNDERSTANDING VALVE CHARACTERISTICS

SEE
PAGE 316



Practical Wireless

EDITOR:
Vol. V. No. 113 || F. J. CAMM || Nov. 17th, 1934.
Technical Staff:
W. J. Delaney,
H. J. Barton Chapple, Wh.Sch., B.Sc. (Hons.), A.M.I.E.E.,
Frank Preston, F.R.A.

ROUND *the* WORLD of WIRELESS

Amazing Success of the £5 Three-Valve Superhet

SOME receivers are born great, some achieve greatness, and some have greatness thrust upon them. It is evident from the heavy loads of correspondence we are receiving that Mr. F. J. Camm's latest receiver, the Three-valve Superhet, was, like all inspirations, born great. He is the first designer to place before you a three-valve superhet suitable for home construction. It will be produced in all styles—a battery version, and an A.C. version have already appeared. A D.C. model and a Universal model will follow. No other designer has displayed the same ingenuity in a receiver. The trade and readers are unanimous in voting it the best receiver of the decade. It is amazingly selective, a hair-line movement will cut out Droitwich, stations simply roll in. Remember you may hear it if you wish. Arrange for a demonstration by writing to the Editor to-day.

String Concert from West Regional

THE tenth string concert will be relayed from the Reardon Smith Lecture Theatre of the National Museum of Wales for West Regional listeners on November 20th, when an interesting concerto grosso by Corelli will open the programme. The works of two modern composers will also be included, namely, suite by Susan Spain-Dunk and a suite by Ricci-Signorini. Parry Jones (tenor) will be the solo artist, and the strings of the Western Studio Orchestra (augmented) will be conducted by Reginald Redman.

"Thé Chantant"

THE new series of programmes entitled "Thé Chantant" will be continued on November 22nd, when a number of tunes from the shows which were running during the War will be heard. Francis Worsley, who is responsible for these programmes, describes it as a sort of twenty-four-hours' leave selection. The programme will be given for London Regional as well as West Regional listeners in the afternoon of November 22nd, and will be repeated for West Regional listeners in the evening of the same day.

IMPORTANT EDITORIAL NOTICE

Will those Readers who have been collecting the Gift Tokens for their Presentation Volume of

NEWNES TELEVISION AND SHORT-WAVE HANDBOOK

please note that the last GIFT TOKEN, No. 9

(provided they started collecting from the first announcement of this offer, see below*)

appears on the back cover of this issue of

"PRACTICAL WIRELESS"

Will readers who are qualifying for this wonderful Presentation Volume affix the last Gift Token to their Subscription Voucher and forward the completed Voucher in accordance with the instructions thereon, TO-DAY.

PLEASE DON'T DELAY

As announced last week there will be an enormous number of volumes to despatch, and it will take some little time to get them all out. All applications will be treated in strict rotation. If you do not receive your volume within 15 days of the despatch of your application—notified by postcard, giving date application was made.

NOTE.—Carefully read instructions on your Subscription Voucher and make sure it is properly filled in before forwarding.

* This will not be your last Gift Token if you did not start collecting until after the first announcement—in which case you continue to collect until you have the necessary nine Gift Tokens attached to your Subscription Voucher.

If you have lost any of your Gift Tokens you may send these in stamps in lieu of each and if by chance you have mislaid the Subscription Voucher, you can still obtain your volume by sending nine Gift Tokens and a remittance of 2s. 6d. (or 3s. 6d. if you want the Library Edition) with your name and address written plainly on a sheet of paper.

Complete and send in your Subscription Voucher immediately you have affixed the last Gift Token to

PRACTICAL WIRELESS
Presentation Department, T.S.H.,
14, SOUTHAMPTON STREET,
STRAND, LONDON, W.C.2.

Any query regarding this offer must be accompanied by a stamped addressed envelope for reply.

"A Touch of Nature"

ON November 23rd, the new "dramatic" studio at Newcastle will make its debut. The play selected is "A Touch of Nature," by Raymond Burns, a Newcastle journalist, and it is dedicated, "without a trace of malice," to the B.B.C. The plot, which centres round an attempt made by an engineer, a professor of ornithology, his wife, and a retired Colonel of the Indian Army to broadcast the song of wild birds, has great humorous possibilities and should make this first broadcast to North Regional listeners from the new studio a memorable one.

North Regional Chamber Concerts

THE second of these popular series of concerts, to be broadcast on November 19th, will be a recital by a distinguished trio consisting of R. J. Forbes, principal of the Royal Manchester College of Music; Henry Holst, a Manchester violinist of great Continental repute; and Carl Fuchs, who has been professor of the violoncello at the Royal Manchester College of Music for many years. Their programme will include a Trio in F Minor by Dvorak, and movements from a Trio in C Major by Haydn.

Manchester Midday Concerts

ON November 20th, two names well known to North Regional listeners—Edward Isaacs and Henry Holst—will be linked together for an important and unique occasion—the 750th Manchester Tuesday Midday Concert. These concerts were begun in 1915, and their extraordinary record includes the bringing forward of many hundreds of young, unknown performers, many of whom have since then, and partly owing to the first chance thus afforded them, reached great fame. Already-famous artists are presented in these concerts also, and Edward Isaacs, the director, has responded to the demands of his own committee and many outsiders, that he should take part in the celebration on November 20th. He has, therefore, obtained the co-operation of his friend, Henry Holst, and their programme will include a Piano and Violin Sonata in A Major, by Edward Isaacs himself (a request item), and the C Minor "Paragita" by Bach, for solo piano.

ROUND the WORLD of WIRELESS (Continued)

Musical Comedy from Scottish Regional

ON November 17th a musical comedy programme will be broadcast from the Scottish Regional. Taking part will be Reginald Talbot (baritone) and the Royal Princess Theatre orchestra, conducted by Robert W. McLeod. The programme will also include popular items from "Dolly Varden," "The Geisha," "Dorothy," "The Shop Girl," "Chu 'Chin Chow," and the "Maid of the Mountains."

Argyll and Sutherland Highlanders Band

THE band of the 1st Battalion Argyll and Sutherland Highlanders will be relayed from the Ideal Homes Food and Fashion Exhibition, Waverley Market, Edinburgh, on November 17th. This programme is of special interest as the regiment will be leaving Edinburgh shortly.

"Tool Making for Jewellers"

THIS is the subject of the next "Young Men in Industry" Talk, which will be given from the Midland Regional on November 19th. William Clulee, of Birmingham, who is to give it, went straight from school to the tool-maker's bench, became charge hand, foreman and, later, a departmental manager, which position he now holds. He recalls how the first pair of tools he made as a boy was thrown into the scrap-heap by a foreman, who insisted on a high standard of workmanship.

"Literary Tour" Series

LINCOLNSHIRE is the subject of the third of the "Literary Tour" series, by Owen Reed, which is to be broadcast from the Midland Regional on November 22nd. The programme has been arranged by Herbert Green, who is Secretary of the Lincoln Chamber of Commerce, and has written several plays, including "These Young People," which was broadcast some time ago. The material he has to draw upon includes Tennyson's "Maud" and "Locksley Hall" and other poems; Jean Ingelow's "High Tide on the Lincolnshire Coast"; several novels, such as "The Mill on the Floss," which includes Lincolnshire scenes; the poems of Bernard Gilbert, who was killed in the War, and Mabel Peacock; the records and history of Lincoln itself, and a mass of folk-lore relating to the county.

Berlin's Radio Police

IN the Templehof district of Berlin, at the Central Post Office, there is a department where wireless experts "police" the radio. With the aid of delicate apparatus, some of which is shown in the illustration on this page, the officials are in position to listen-in and keep watch over every broadcasting station in the world. Their chief duty is to control the different wavelengths of the German broadcasting stations, so that they do not interfere with one another.

"West Country Gazette"

THE second issue of "West Country Gazette" will be presented by Francis Worsley for West Regional listeners

INTERESTING and TOPICAL PARAGRAPHS

on November 15th. The contents include an Editorial, Gardening Notes by Reginald Arkell, To-day's Birthday, Music Notes, a

BERLIN RADIO POLICE



The complicated apparatus used in the Central Post Office in Berlin, for checking wavelengths.

contribution by A. G. Street, and "Off the Tape," a topical supplement.

The Arcadian Follies

THIS popular troupe of entertainers—including several artists well-known through relays from Blackpool and Morecambe—are to broadcast "a sparkling vaudeville entertainment" to North Regional listeners from the Royalty Theatre, Chester, on November 15th.

Launch of the Orion

IT is hoped that the ceremony of the launching of the new Orient liner *Orion* at Barrow-in-Furness on December 7th will be broadcast in home and Empire programmes. The launching of the vessel will be performed by his Royal Highness the Duke of Gloucester, who will be attending a concert given by the Returned Soldiers' and Sailors' Imperial League at Brisbane, Australia, on that day. The concert will be interrupted for the Duke to press a button which will provide a radio impulse sufficient to set *Orion* in motion down the slipway. As she moves off, a "tripper" will be actuated automatically which will break a bottle of Empire wine against her bows.

R.I.B.A. Centenary Banquet

ON November 22nd a speech by the President, Sir Giles Gilbert Scott, R.A., will be broadcast from the Royal

Institute of British Architects' Centenary Banquet, to be held at the Guildhall.

Orchestral Concert from Midland Regional

VICTOR HELY-HUTCHINSON, formerly Midland Music Director, and now Professor of Music at Birmingham University, is to play Mozart's "Concerto in A" at the Sutton Coldfield Orchestral Society's Concert on November 19th. Harold Gray conducts the Orchestra. In the Midland Composers Concert on November 23rd, when Leslie Heward conducts the B.B.C. Midland Orchestra. Hely-Hutchinson's "Symphonic Variations" are among the works to be given.

"Tea Time Yesterday"

TWO plays performed by the Birmingham Repertory Theatre Company are to be relayed from their own studio on November 20th. One is by H. C. G. Stevens, entitled "Tea Time Yesterday"—a little comedy of a village shop and its owner's matrimonial affairs. The other, specially written for the microphone and using broadcasting technique, presents, in four rapid scenes, the story of a £5 note and what it can do. Herbert M. Prentice is the producer.

Organ Recital by Reginald New

ON November 23rd Reginald New broadcasts from the Regal Cinema, Kingston-on-Thames; and in the evening, from the Cheltenham Town Hall—120 miles away from the Thames-side town! With him for the Midland Regional broadcast in the evening are Alan Walker and Arthur Cole (two pianos).

SOLVE THIS!

PROBLEM No. 113.

After fitting a pentode valve to his three valves, Jamieson found that the high notes were rather too prominent. He therefore decided to fit a tone control, and accordingly purchased a 10,000 ohms variable resistance and joined this across the loud-speaker. He found, however, that this not only altered the tone, but acted as a volume control, and gave a very poor variation in tone owing to the loss of volume. Why was this? Three books will be awarded for the first three correct solutions opened. Envelopes must be marked Problem No. 113, and must be addressed to the Editor, PRACTICAL WIRELESS, Geo. Newnes, Ltd., 8-11, Southampton Street, Strand, London, W.C.2. Entries must be posted to reach this office not later than the first post Monday, November 19th, 1934.

Solution to Problem No. 112.

When Jackson added his extra valve he was depriving the remaining valves of L.T. current, as the transformer only delivered 2 amps. Furthermore, the extra H.T. requirements overloaded the mains portion and thus reduced the output.

The following three readers successfully solved Problem No. 111, and books have accordingly been forwarded to them: N. H. Townsend, The Green, Houghton Regis, Dunstable, Beds. A. Foulkes, 6, Bromyard Avenue, Acton Vale, W.3. H. Hart, 1, Kensington, Bath, Somerset.

OUR LOW PRICE CAMPAIGN

ECONOMY IN HOME CONSTRUCTION

An Explanation of One or Two Simple Modifications which can Often be Introduced with the Object of Reducing the Cost of Home Construction

ONE of the reasons why manufacturers of receivers can produce their sets at such low prices is that they are frequently able to effect a great economy in the number of components which they use. Provided that care is taken to retain all the essential parts, there is no reason whatever why the constructor should not follow the same methods as those employed by the manufacturers. The constructor must, of course, be prepared to experiment to a certain extent because, obviously, components cannot simply be taken away without putting something else in their places, or making some modifications to the circuit wiring.

Saving an H.F. Choke

There are probably many readers who have already found out that, in the simpler types of receiver at any rate, it is very often possible to dispense with the detector, or reaction, H.F. choke. This is almost invariably the case when a reaction condenser of fairly high capacity is employed, and when oscillation ceases while the vanes are in sufficient mesh to provide a capacity of .0001 mfd. or more. The same thing applies when the detector anode is provided with a small-capacity by-pass condenser. In cases such as those quoted a choke is rarely necessary, due to the fact that the H.F. currents which leak through to the anode of the detector are led away to earth direct, and therefore do not require to be choked back from the H.T. circuit. Sometimes when the detector H.F. choke is removed it is found that reaction is rather unsteady, or that a certain amount of instability is present. It is then often desirable to connect a fixed resistance of about 500 ohms in place of the choke; this generally proves sufficient to prevent any serious leakage of H.F. into the L.F. circuits.

The Screening-grid Supply

It has frequently been pointed out in these pages that it is best to feed the screening grid of an S.G. or V.M. valve by means of a fixed potentiometer, as shown in Fig. 1. The arrangement involves the use of two fixed resistances and a fixed by-pass condenser of about 1 mfd. in addition to the other feed resistances and condensers used in the set. A very simple method of avoiding the expense of the parts mentioned, however, is shown in Fig. 2, where it will be seen that the detector valve and its anode decoupling resistance together form the screening-grid potentiometer, whilst the 1 mfd. S.G. by-pass condenser also acts as decoupling condenser for the detector.

The arrangement is perfectly straight-

forward and quite logical; it has, in fact, been used by the writer in a number of receivers with complete success. The chief point to bear in mind is that the potentiometer comprising the filament-anode path of the detector valve and the decoupling resistance must be of such a value that the correct potential is applied to the screening grid. In the majority of cases the voltage required is half of that applied to the anode of the S.G. valve, so that the resistance between points A and C must be approximately the same as that between

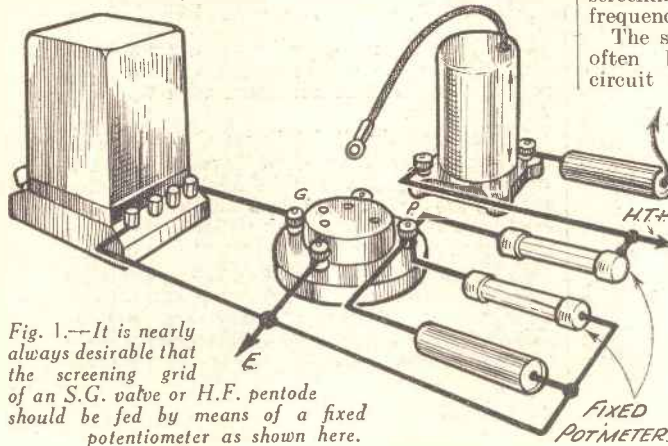

Fig. 1.—It is nearly always desirable that the screening grid of an S.G. valve or H.F. pentode should be fed by means of a fixed potentiometer as shown here.

B and C. The value of A—C is fixed, and therefore must be known before the correct value for the decoupling resistance can be settled. The resistance of the valve can easily be found by looking up the characteristic curves issued by the makers—remember, however, it is the D.C. resistance and not the A.C. resistance which is required. Should it be found that the valve passes an anode current of, say, 3 milliamps at 100 volts, it will be known that its D.C.

resistance (by Ohm's Law) is approximately 33,000 ohms ($100 \div 3/1,000$).

Finding the Resistance

The D.C. resistance of the primary winding of the L.F. transformer will be about 2,000 ohms, so that the total resistance of the "lower arm" of the potentiometer can be taken as being 35,000 ohms. A resistance of this value will therefore be suitable for use as decoupler, when the screening-grid voltage requires to be 60 volts, whilst the anode voltage is 120. If the makers recommended a higher voltage than this it could easily be obtained simply by using a lower value of decoupling resistance. For example, if the S.G. voltage should be 80, or two-thirds of the anode voltage, the decoupling resistance must have a value of one-half the resistance of the valve and transformer primary—that is, about 20,000 ohms, in round figures.

When using this arrangement it is important that the combined decoupling by-pass condenser should be entirely non-inductive, and that it should be placed as close as convenient to the screening-grid terminal on the high-frequency valveholder.

The same idea as mentioned above can often be applied even to a superhet circuit which incorporates two or more

S.G. valves, but in this case the various screening grids must be decoupled by inserting a fixed resistance of about 1,000 ohms in series with each. Additionally, it will be necessary to provide separate by-pass condensers for the screening grids, as well as a separate decoupling condenser. The saving in this case is thus not very large, but might often be considered worth while. In using the arrangement, the decoupling resistance must be of rather lower value than as found by simple calculation above, because it will pass the current required by the screening grids as well as the anode current of the detector valve. The additional current in the first case considered was almost negligible, but when there are two or more S.G. valves to be fed the difference should be taken into consideration, the decoupling resistance being about two-thirds of the theoretically-calculated value.

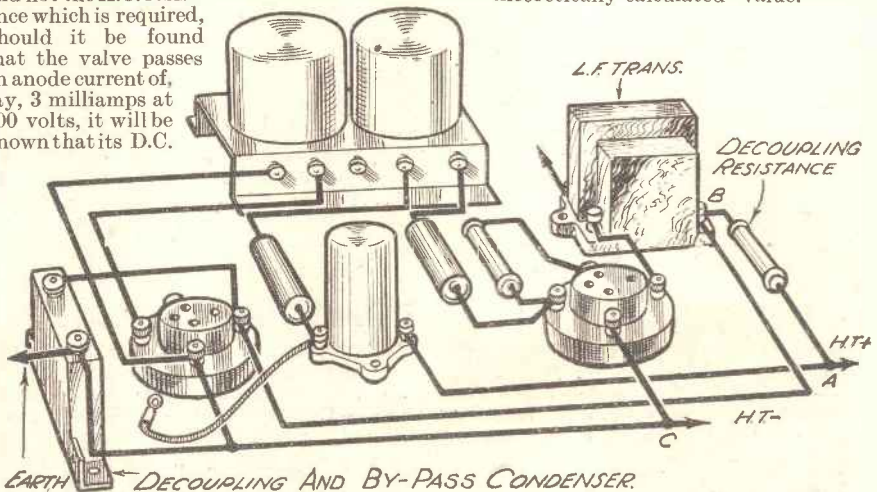

Fig. 2.—The above skeleton circuit shows how it is possible to economise by using the detector valve and its decoupling resistance as two "arms" of a fixed potentiometer for the S.G. voltage supply. Note also that a single condenser serves as an S.G. by-pass and for detector decoupling.

CONVERTING TO R.C. COUPLING

How to Change Over in Order to Obtain Better Reproduction

By "LAMBDA"

IT may sometimes happen that it is desired to convert the low-frequency side of a receiver from transformer to resistance-capacity coupling, in order to obtain the best quality for the reception of television signals.

The conversion is facilitated if a mains set is used in which the field winding of the moving-coil loud-speaker is used as a

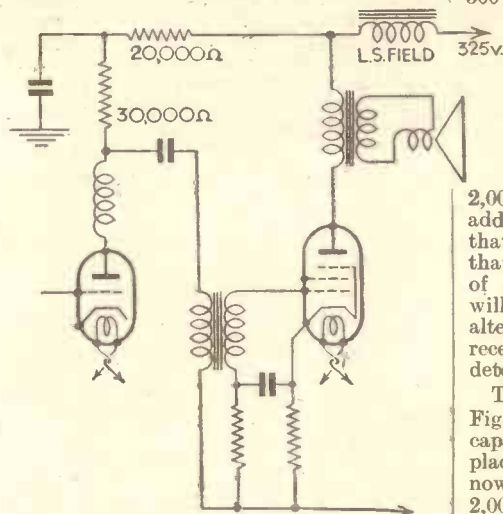

Fig. 1.—Circuit diagram of a transformer-coupled L.F. stage.

smoothing choke. If this be dispensed with at least an additional 100 volts are available, and the conversion can be carried out quite satisfactorily with very pleasing results. In a conventional type of receiver, employing one H.F. stage, detector, and pentode output, the volume and amplification will be quite satisfactory.

Value of L.F. Choke

First of all, it will be necessary to insert a low-frequency choke in place of the field winding of the moving-coil loud-speaker. This may have a D.C. resistance of about 500 ohms, and consequently the voltage drop will not be very great; assuming 50 mA. passing, this will amount to 25 volts.

If the maximum voltage available is, say, 350 volts, and 25 volts are dropped in the existing smoothing choke, we now have available 300 volts.

Next, it will be necessary to insert a 2,000-ohm resistance in series with the additional low-frequency choke in order that the total D.C. resistances may equal that of the substituted field winding of the moving-coil loud-speaker. This will obviate the necessity for making any alteration to the other resistances in the receiver except those associated with the detector valve.

The original circuit details are shown in Fig. 1 and the re-arrangement for resistance capacity coupling shown in Fig. 2. In place of the loud-speaker field winding we now have the low-frequency choke L and 2,000-ohm resistance R. It will be observed that the positive lead to the anode of the detector valve is now taken from point A. Now insert a resistance of 40,000 ohms in series with the anode of the detector valve in place of the existing resistance, if parallel-fed transformer coupling has been employed, or in lieu of the primary winding of the low-frequency transformer. The capacity coupling C should then be connected together with the 0.25 megohm grid leak.

Decoupling Resistance

A decoupling resistance of 15,000 ohms is shown in the detector-anode circuit, and this may be the lowest value it is possible to employ in order to prevent motor-boating. The by-pass condenser associated with the biasing resistance in the cathode lead of the output valve should now be connected in parallel with it.

Assuming a valve of the MH4 type to be employed as a detector, it has an impedance of 11,000 ohms, and an average anode current consumption of 4 mA. The voltage drop across the two resistances

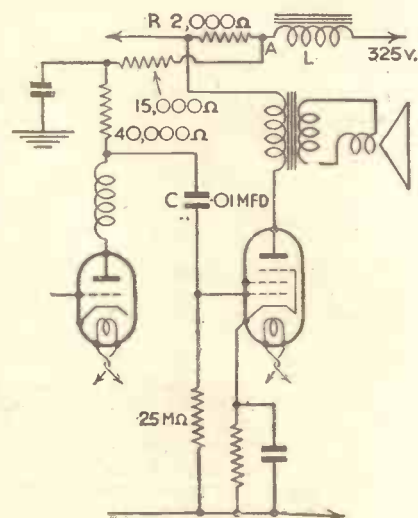

Fig. 2.—Circuit diagram of an R.C. coupled L.F. stage.

will therefore be 220 volts and 80 volts will be available at the anode of the detector valve. The conversion will prove quite satisfactory with very pleasing results.

Northumberland Fusiliers Band

CONDUCTED by J. L. Evans, the band of the 2nd Battalion the Northumberland Fusiliers, will broadcast to North Regional listeners from Leeds on November 15th.

"The House Where I Was Born"

THE last talk in this series, by John Capel, will be given in the West Regional programme on November 16th. In this talk he will tell of his life among the hills. In the first two talks the sea and the river claimed his attention.

Chopin Recital from Scottish Regional

JULIAN ROSETTI, who will give a Chopin recital for Scottish Regional listeners on November 18th, has a link with the great Polish composer, having been a pupil of Georges Mathias, who was himself one of Chopin's pupils. Mr. Rosetti also studied with Paderewski, and at the early age of thirteen did a concert tour of Poland and Germany. Aberdeen, in which Mr. Rosetti has made his home, has good reason to be grateful to him for his untiring interest in the musical life of the city.

PROGRAMME NOTES

Reid Orchestral Concert

CASALS, the distinguished violoncellist, will appear in the Reid Orchestral Concert, which is being relayed from the Usher Hall, Edinburgh, to Scottish Regional listeners on November 22nd. The two principal items will be the Concerto for Violoncello and Orchestra, by Professor D. F. Tovey and the Concerto for Violoncello and Orchestra, by Haydn. During the interval Miss Catherine Fletcher will read "When Music Sounds," by Walter de la Mare, and the "Ode on a Grecian Urn," by Keats.

Annie Shand's Dance Band

THIS popular band, to which Princess Marina danced on her first visit to Balmoral this summer, will broadcast on November 24th. This band has had the unique distinction of playing at every Gillies' Ball at Balmoral during the past

fifteen years, and is in great request at the Graduation Dances of the University of Aberdeen. The late Marquess of Aberdeen celebrated his silver and his golden weddings to the music of the band and the present Lord Aberdeen danced to it at his wedding. Dufton Scott, the popular North-east entertainer, will delight listeners with his racy stories of life in that part of Scotland.

"In the Roar of the Sea"

THIS well-known story, by Baring-Gould, has been chosen for the first of a series of dramatizations of famous West Country stories for West Regional listeners on November 22nd. Other stories which will be dramatized and included in this interesting series are "Lorna Doone," "Westward Ho!" and "Captain Blood."

Variety Programme from Bolton

AN excerpt from the variety bill at the Grand Theatre, Bolton, will be broadcast to North Regional listeners on November 21st. Apart from a special charity broadcast several years ago, this is the first time a show from the Grand has been "on the air." Its belated radio debut should, however, be a great success.

ELIMINATING MANUAL CONTROLS

An Article Giving the Reasons for the Simplification Which Has Taken Place in Recent Years.

It is interesting to inquire whether all the controls to be found on old radio receivers were necessary, and, if so, why they were wanted. Discussion can then turn on the reasons for the striking simplification which has taken place in recent seasons, and finally it is worth while considering whether any further reduction in the number of controls is likely to take place.

Early Controls Necessary

It may be admitted right away that all the controls, numerous as they were, on an old-fashioned set were necessary and served a very good and useful purpose. True, it was fashionable, in those days, to make knobs and gadgets as conspicuous as possible. Perhaps this was in order to impress the layman with the mysterious and important nature of radio, and the

of one H.F. stage converted the set from an all-station receiver to a local-station instrument, while the ability to cut out one L.F. stage enabled the listener to accommodate the receiver to stations of different powers, or to arrange for medium or full volume at will.

The reaction control was not at that time considered mainly as a form of volume control. It was used almost solely as a means of increasing the sensitivity of the set for the purpose of receiving the more distant stations, and, as a matter of fact, it was usually impossible to receive any but the most powerful transmission without adjusting reaction almost to the verge of oscillation. Rough adjustment of volume, therefore, was made by varying the number of valves employed, and thereafter minor control was exercised by means of the

filament rheostats. All this, of course, would be considered very bad practice to-day, but then it was almost essential.

Another reason for the provision of switches for cutting out one or more valve stages was as a means of economising in both L.T. and H.T. current. Filament currents in general were much higher than to-day and H.T. batteries not so reliable and much more expensive. It was, therefore, a boon to be able to run economically when the full power of the set was not really necessary, and the scheme also made it possible on occasion to hold out to the end of a programme on two or three valves when batteries were partly run down, and could not have sustained the full load throughout the evening.

Ganging

Finally, it must be remembered that every tuned circuit in an early receiver meant a separate tuning condenser, since ganged condensers were unknown; and even if they had been available there was not a sufficient degree of uniformity between coils and other components to make the use of dual or triple condenser blocks practicable.

As components became to be more



A modern receiver ("The Leader Three") with controls reduced to a minimum.

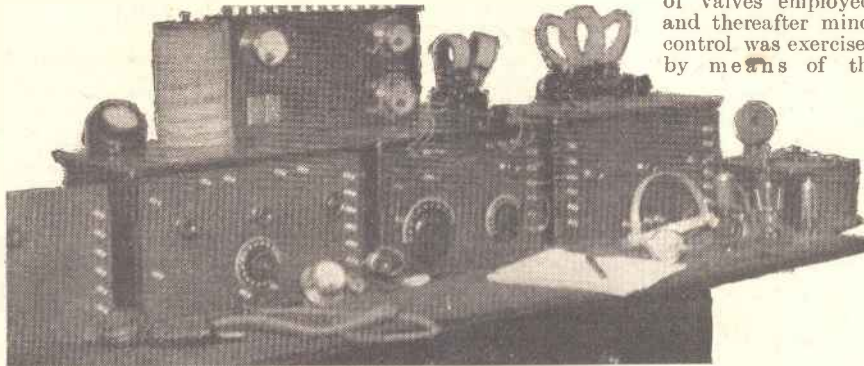

An early type of receiver showing the large number of control knobs.

cleverness of the "experts" who built and operated the sets, and it may be conjectured that manufacturers of components were not altogether free from suspicion of having pandered to those little human weaknesses.

But it cannot be denied that in the state of radio as existed about 1926 many more controls and adjustments were necessary than are needed to-day. Take, for example, an "ideal" family receiver of that date; no exception can be taken to the battery switch. The two wave-change switches were essential as the high-frequency coupling was of the tuned-anode type, and separate switches had to be used for aerial and anode coil; also ganging of switches was unknown at that time. The filament rheostats were desirable because valve manufacture had not progressed to the extent it has to-day, and somewhat critical adjustment of filament current was necessary for optimum results, especially in respect of the detector valve.

Reasons of Economy

Switching for eliminating one or more stages was quite a valuable adjunct in these early receivers. In the first place, the removal

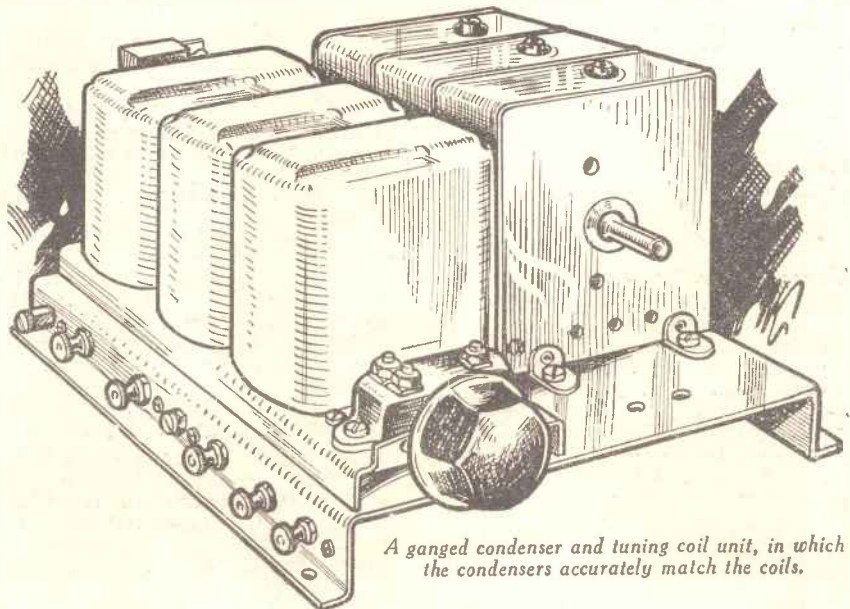

A ganged condenser and tuning coil unit, in which the condensers accurately match the coils.

accurately made and a knowledge of circuit design increased, many of the variables which required adjustment in old receivers could be eliminated. Valves were made with filaments which would operate satisfactorily with a 2-volt, 4-volt, or 6-volt accumulator as the case might be, at any state of charge, without the use of a rheostat. Improved sensitivity of valves and increased efficiency of coils decreased the importance of reaction as a mere station-getting device, and permitted its use in its true rôle of volume control, so that valve switching became unnecessary. Accurately made coils and condensers made possible ganged tuning assemblies, and a further reduction in the number of knobs, while the wave-change switches of the different coils could also be ganged for operation by a single knob.

Additional Controls

At the same time, the desire to introduce other improvements, such as more realistic tone, brought about the addition of new controls, such as tone correctors, variable selectivity devices, wave-traps, and so on. Still, there has been a net reduction in the number of controls, and the average for a set now stands at from three to four in a well-designed receiver, with one or perhaps two others in very special circumstances.

Analysing modern receiver design, it would appear that only three main types of control ought to be provided upon the panel. A receiver is intended for receiving radio stations as and when desired, and at any reasonable degree of loudness, again in accordance with the listener's wishes. Granted this, the only essential controls are, first, a means for putting the set in or out of action; second, a means for selecting the required programme; and third, a means for controlling the degree of loudness.

To what extent can these three controlling functions be operated by a minimum of knobs? Well, the on-off switch represents one definite control, and probably one knob. Programme selection means one tuning knob operating ganged condensers; it also means a wave-change switch, and, if pick-up terminals are provided, a gramophone-radio switch. Volume control means at the minimum one radio control (probably reaction) and more likely two—reaction and variable-mu control; if pick-up is incorporated there will also be an L.F. control.

Suggested Combinations

There are ways and means of performing all these operations with a reduced number of operating knobs, and the following combinations all represent quite modern practice:—

Four Controls:—

- 1—On-off switch and wave-change;
- 2—tuning; 3—volume; 4—reaction.

Three Controls:—

- 1—On-off, wave-change and gramophone;
- 2—tuning; 3—volume on radio and gramophone (ganged). Alternatively, 1—On-off and volume; 2—tuning; 3—wave-change and gramophone (ganged).

Two Controls:—

- 1—On-off and volume; 2—tuning and wave-change.

These simplifications can be achieved by the use of ingenious designs of switches, by coupling two or more controls to a common spindle, or by the use of concentric knobs and spindles.

A FIVE-VALVE TRANSMITTER

Some Details of a Good 10-watt Transmitting Circuit Suitable for the Advanced Experimenter

SINCE we published details of transmitting circuits we have received many requests for more detailed matter. It must be pointed out, however, that no experiments in transmission may be carried out unless the experimenter holds the Post Office Transmitting Licence, and therefore those readers who are desirous of experimenting with this branch of radio should first get into touch with the P.M.G. with a view to obtaining this licence. Modern requirements regarding quality, etc., render it necessary to use great care in avoiding stray couplings, and also to keep all losses down to a minimum. In fact, in these respects the design should

prevent interaction. Suitable leads will serve for connection to the rest of the apparatus.

The Modulated Amplifier

The modulated amplifier employs a T.25D, which is a particularly robust valve utilising an oxide-coated filament rated to consume 1.1 amps at 6 volts. It is fitted with the standard four-pin receiving valve base, although it is a transmitting valve. This reduces the constructional difficulties which might be encountered when special valves are employed. The inter-electrode capacities in this particular valve are very low, and at the maximum of 10 watts output

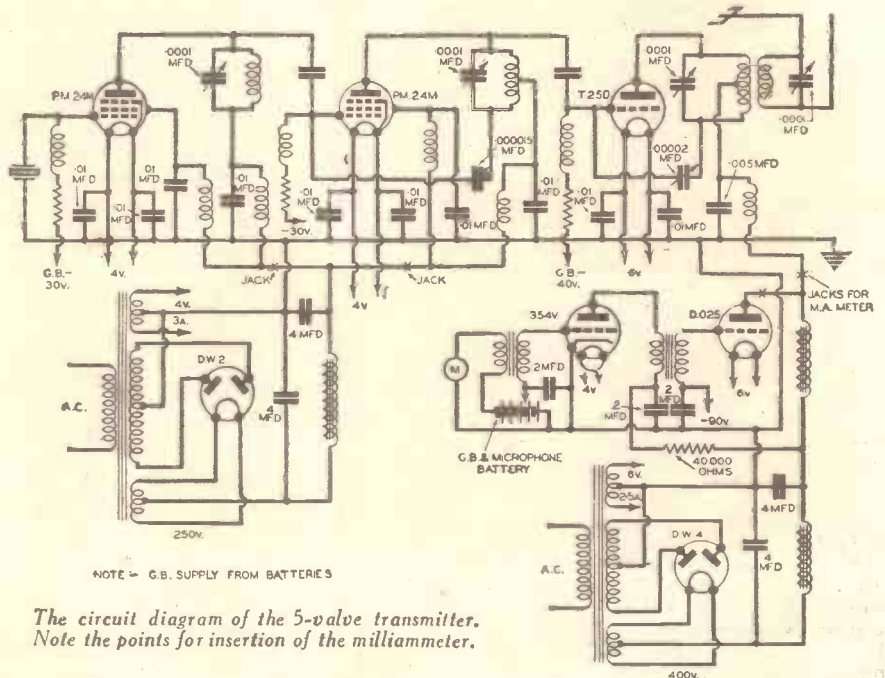

The circuit diagram of the 5-valve transmitter. Note the points for insertion of the milliammeter.

be modelled on the lines of a high-class receiver. The circuit which is given will be found highly satisfactory for good class telephony, and possesses some points of interest.

Crystal Oscillator

Two pentodes are employed for the buffer amplifier or frequency doubler, and a crystal oscillator precedes these stages. Mullard PM.24M valves are employed here, with their own high-tension supply derived from a small mains unit employing a Mullard DW2 rectifier. It should be noted that the second valve will not require to be neutralised if it is used as a frequency doubler. The choke in the lead from this part of the circuit should be of 30 to 50 henries and of fairly low D.C. resistance. This part of the transmitter should preferably be arranged on a separate baseboard and enclosed in a metal box in order to

the transmitter may be operated right down to 15 metres without difficulty. The modulator valve is a D.025, fed from a 354V. used as a microphone amplifier. These three valves are fed from another small mains unit in which a D.W.4 supplies the necessary potentials, the choke in the positive lead again being of the 30 to 50 henry type with low D.C. resistance. In order to avoid difficulties battery supplies are adopted in each stage for biasing purposes and this will be found of great advantage. All parts should be of the standard transmitting type, and there are many such from which to make a selection. The values of the grid leaks will be between 5,000 and 10,000 ohms, the actual values being determined experimentally.

Component Values

Most of the components' values are (Continued on page 330)



READERS' WRINKLES



An Improved Test Prod

THIS simple idea forms a useful addition to the test prods included in the PRACTICAL WIRELESS tool kit. The only parts required are a dial lamp holder and bulb.

A 4B.A. thread must first be tapped into one of the test prods. If the bolt which secures the holder to its base is 4B.A. it is screwed straight into this. But if, as

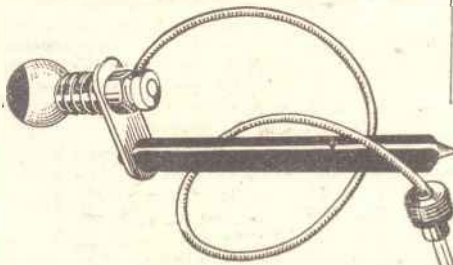

Improving the "Practical Wireless" test prods.

is more likely, it is of a smaller size, the other terminal must be removed from the holder, and the hole must be enlarged with a 5/32in. drill. The tapped prod is then bolted to the holder with a 4B.A. bolt as shown.

A length of flex is fixed under the remaining terminal and joined to the second test prod by means of a wander plug. With a lamp inserted this is ideal for testing filament circuits. For continuity tests (in any low resistance circuit) connect a flash-lamp battery, or 3 volts of the G.B. battery, between the two test prods.—WM. E. ASHTON (Foulon, Guernsey).

A Handy Drill Chuck

WHEN using 1/16in. drills they have a tendency to break in the middle. To avoid this trouble I made the simple chuck, shown in the accompanying illustration, which has effected a great saving in drills. A 1/2in. B.S.F. bolt 2in. long was obtained and the head cut off with a hacksaw. Through the centre of the bolt a 1/16in. hole was drilled and one end of the bolt ground to a taper. This was slotted with a fine hacksaw and a special nut made from a piece of 3/8in. diameter by 7/16in. M.S. bar, as shown in the sketch.—CHAS. WALKER (Hayes).

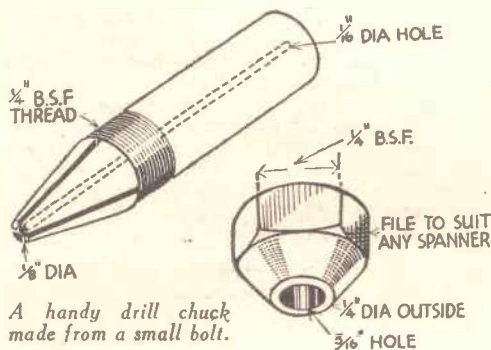

A handy drill chuck made from a small bolt.

THAT DODGE OF YOURS!

Every Reader of "PRACTICAL WIRELESS" must have originated some little dodge which would interest other readers. Why not pass it on to us? We pay £1-10-0 for the best wrinkle submitted, and for every other item published on this page we will pay half-a-guinea. Turn that idea of yours to account by sending it in to us addressed to the Editor, "PRACTICAL WIRELESS," George Newnes, Ltd., 8-11, Southampton Street, Strand, W.C.2. Put your name and address on every item. Please note that every notion sent in must be original. Mark envelopes "Radio Wrinkles." Do NOT enclose Queries with your Wrinkle.

Single Wire Control

THE accompanying diagram shows the method I employ in controlling the volume of the set when listening-in to a speaker in any other room. It will be noticed that two condensers are employed, one in the set, i.e., filter output, and the other on the extension speaker—of a capacity of from 2 to 4 mfd. A 50,000 ohm potentiometer (B) is connected across a 9-volt grid bias battery. From one terminal on the speaker (that nearest the anode) to the moving arm of the potentiometer is connected a 250,000 ohm non-inductive resistance (A). The speaker is connected to earth through the 4 mfd. condenser; the grid bias battery positive to earth by way of the earth terminal of the condenser.

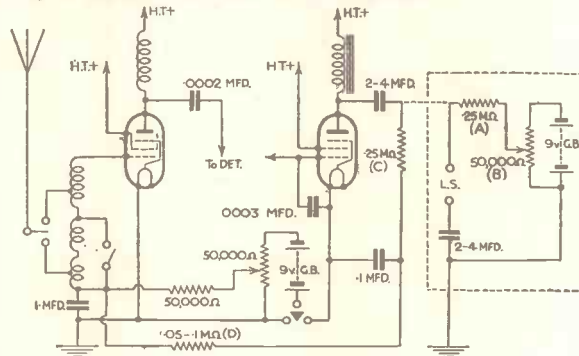

Circuit diagram of a single wire control.

Another 250,000 ohm resistance (C) is connected between the filter output condenser and the earth end of the tuning coil before the variable- μ H.F. valve. D is another resistance which may be inserted in conjunction with the .1 mfd. condenser. It will be noticed that only one wire is employed to control the set, [and to carry the signal currents to the extension speaker]. The resistance A must not be less than 100,000 ohms, if the full output from the extension speaker is desired with pleasurable quality; nor must it be more than 250,000 ohms. If it is, the volume control has very little, if any, effect on the volume. It may here be pointed out that the resistance C is essential. If it is not fitted the signal currents will

feed back to the H.F. valve and cause complete instability. The resistance D may be fitted close to the earth end of the tuning coil. The volume control potentiometer, the 2.4 mfd. condenser, the grid bias battery, and the .25 megohm resistance may be housed in the cabinet of the extension speaker, or in a small box, with terminals fitted for the input and output (earth) and speaker.—R. M. ROSS (Alness).

A Triple-purpose Switch

WHEN making a radiogram recently I used the following dodge to control the on-off, wave-change, and radio-gramo-

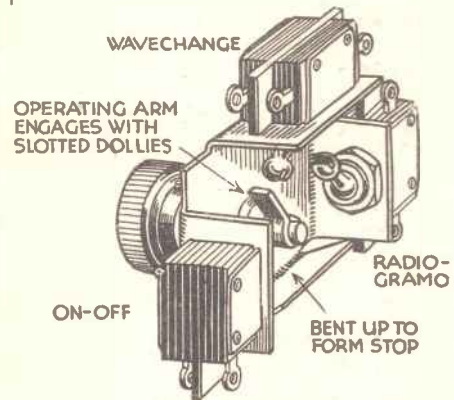

A compact triple-purpose switch arrangement.

phone switches with one knob. The switches are all QMB type. The diagrams show how they are mounted after they have been "dollied." Brass 1/16in. thick was used for the chassis, and an old rheostat provided the bearing and the shaft. The moving arm is made of brass and bolted to the shaft. Minor adjustments can be made by altering the nuts of the switches, and by filing the moving arm.—R. A. ROBINSON (Whitwell).

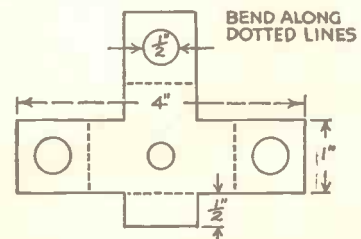

Mounting plate for combined switch, before being bent to shape.

PRACTICAL MECHANICS
6^D EVERY MONTH.

UNDERSTANDING VALVE CHARACTERISTICS

A Simple Explanation of the Principal Valve Terms and of the Methods of Determining Amplification Factor, Mutual Conductance, Impedance, etc.

By FRANK PRESTON

TO the uninitiated, many of the expressions used in describing the characteristics of valves are beyond comprehension, whilst the mere mention of characteristic curves is sufficient to cause a complete loss of interest. There is no reason why this should be the case, because the points involved are by no means difficult to understand, provided that the matter is viewed from the right angle. It should also be pointed out that a fair knowledge of valve characteristics is essential if any intelligent experimental work is to be undertaken.

Static and Dynamic Characteristics

In the first place it should be mentioned that there are two general kinds of characteristic—called static and dynamic. As the names imply, these are used in connection with a valve which is idle (static) and with one which is being fed with varying grid voltages (dynamic). Obviously the latter condition is the more important, but the figures applying to it are rather more difficult to obtain, due to the fact that several variable factors have to be taken into consideration. By contrast, there is usually only a single variable factor to be considered when dealing with the static characteristics. Additionally, it should be pointed out, the difference between static and dynamic is not very pronounced in most instances, and the static characteristics provide all the data which is required in the majority of cases. For these reasons it will be sufficient here to deal with static conditions only.

A.C. Resistance

One of the commonest of valve terms is impedance, or A.C. resistance. This refers to the resistance to alternating currents of the filament-to-anode path. The relevant figure is generally stated by the makers of the valve, but it can easily be found by dividing the change in anode current into the change in anode voltage required to produce it, assuming the grid voltage to remain constant. This sounds a little complicated; the idea may be followed, however, by referring to the anode-current-grid volts curves given in Fig. 1. Assuming a fixed grid-bias voltage of 4, it will be seen that the current passed by the valve in question with an anode voltage of 125 is approximately 8 milliamps; when the anode voltage is increased to 150, however,

the anode current becomes 15 milliamps. The current difference is 7 milliamps (7/1,000 amp.) and the voltage difference is 25, so that the impedance is 25 divided by 7/1,000, or practically 3,600 ohms, which is the figure given by the makers for the particular valve considered.

Amplification Factor

A term which sounds more interesting is amplification factor (usually indicated by the Greek letter μ). This refers to the

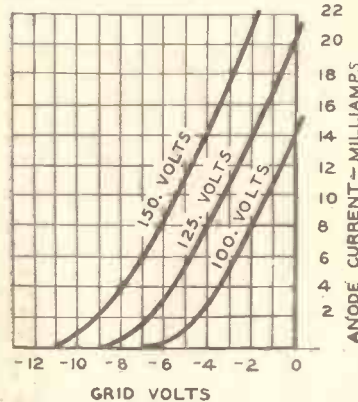

Fig. 1.—Grid volts-anode current curves for a typical high-amplification small three-electrode power valve.

change in grid volts required to give the same effect as a corresponding change in anode voltage, the anode current remaining unchanged. It is a ratio, and is found by dividing the change in anode voltage by the change in grid voltage. If reference is again made to Fig. 1 it will be seen that the valve represented passes an anode current

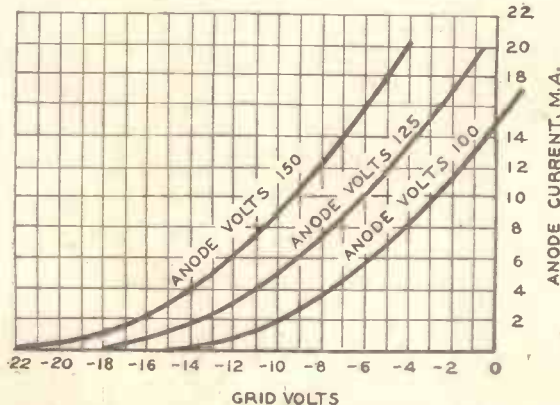

Fig. 2.—These curves are for a super-power valve. Note the less-steep slope indicating lower value of mutual conductance.

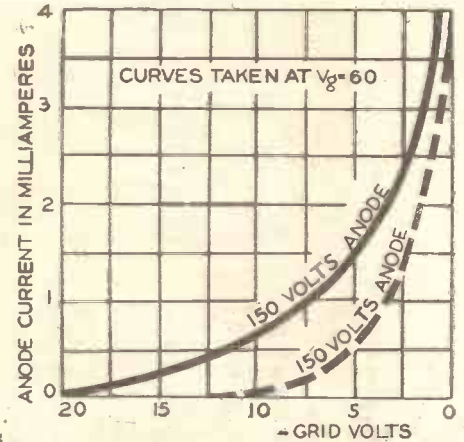

Fig. 3.—Curves which show the difference between long- and short-base variable- μ valves. The characteristics of the short-base valve are indicated by the broken-line curve.

of 12 milliamps when its anode voltage is 100 and its grid voltage minus 1. It will also be seen that when 150 volts is applied to the anode minus 5 volts is required on the grid to maintain the anode current at the same figure. The amplification factor is, therefore, 50 (150-100) divided by 4 (5-1), or 12.5. It need scarcely be explained that the output of any valve for a given input is dependent principally upon the amplification factor—the higher the factor, the greater the signal output.

Slope

Another factor which gives similar information, but which is somewhat more reliable and more frequently used nowadays, is the mutual conductance, or slope. This is found by dividing the change in anode current by the change in grid volts, assuming a constant anode voltage. Referring again to Fig. 1 and taking the average (125-volt) curve it will be seen that the valve passes 16 milliamps when the negative grid-bias voltage is 1½. When the bias is increased to minus 4 volts the anode current is reduced to approximately 8 milliamps. It will be seen, therefore, that the mutual conductance is rather better than 3 milliamps per volt, when the valve is operated between the two extreme conditions mentioned. The makers usually state the mutual conductance at zero grid volts and 100 volts H.T., and in that case the figure is a little higher than that arrived at above.

From the above explanation it will be understood why the mutual conductance is often referred to as the slope—because it depends upon the steepness of the slope of the anode-current-grid volts characteristic curve. A steep-slope valve has a high mutual conductance and gives a high degree of amplification. This point will be appreciated by comparing the curves in Fig. 1 (which apply to a valve of the small-power high-amplification type) with those given in Fig. 2 (which are for a super-power valve of the medium-amplification type).

Optimum Load

Another valve expression which is often used is optimum load. The appropriate figure is given in ohms, and indicates the resistance of the coupling component used in the anode circuit required to ensure the greatest transference of energy from one valve to the next, or from the output valve to the loud-speaker. It is not a very simple

(Continued on page 323)

The A.C. VERSION

of the

£5 THREE-VALVE SUPERHET

is designed, not only for "quality" performance, but also for

RELIABILITY

No A.C. set can be termed reliable unless the power unit will deliver a constant undeteriorating High Tension Supply.

The Mains Unit specified for the A.C. £5 Three-Valve Superhet is equipped with a permanent Westinghouse Metal Rectifier. Nothing to burn or wear out. No renewals. No "Mid-programme" fade-outs. Westinghouse Metal Rectifiers never die. They don't even fade away, but go on supplying high tension for as long as the set itself is in use.



METAL RECTIFIERS

THE WESTINGHOUSE BRAKE & SAXBY SIGNAL CO., LTD.,
82, York Road, King's Cross, London, N.1.

COUPON

Please send me a copy of "The All Metal Way, 1935" giving full particulars of your permanent metal rectifiers, and containing circuits and instructions for their use. I enclose 3d. in stamps.

Name

Address

PRACT. 171134.

ONLY J.B. SPECIFIED FOR THE "£5 3-VALVE SUPERHET"

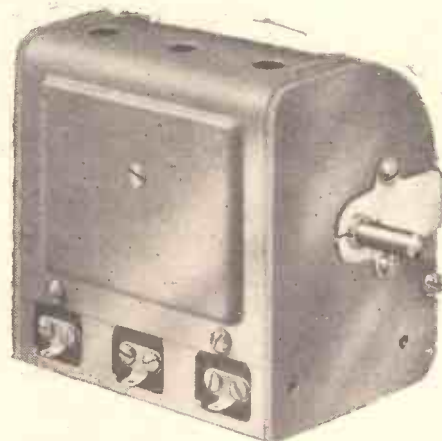

J.B. 'BABY' SUPERHET GANG
3 Gang 16/-

This Jackson Bros. 'Baby' Superhet Gang is essential to the success of your "£5 3-Valve Superhet." Specially chosen by Mr. F. J. Camm—all home constructors should use it.

USE ONLY



Jackson Bros. (London) Ltd., 72, St. Thomas' Street, London, S.E.1. Tel: Hop 1837.

ONLY EIGHT AND SIX—

and a FERRANTI at that!

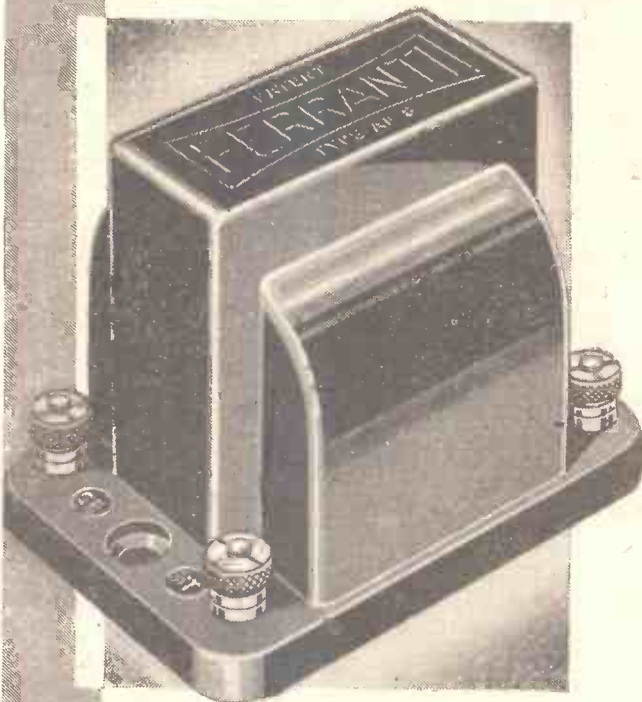

This AF10 Transformer has no superior in its price class.

It employs the FERRANTI sectional windings on non-hygroscopic bobbins which are known the world over. It is not only capable of providing fine reproduction but will keep on doing it indefinitely, robust construction being a well-known feature of all Ferranti Transformers.

Primary Inductance 35/20 henrys. 0.6 milliamperes. Ratio 1/3. Price

8/6



FERRANTI LTD, HOLLINWOOD, LANCs.
LONDON: BUSH HOUSE, ALDWYCH, W.C.2.



● The London to Melbourne Air Race was won on accuracy—accuracy of workmanship, accuracy of navigation. Accuracy was a matter of life and death to Scott and Black.

So with condensers. Accuracy in these vital components is not, it is true, a matter of life and death, but it is a matter of good and bad reception. You can make sure of getting accurate condensers by insisting on T.M.C.-HYDRA condensers.



T.M.C.
BRITISH MADE
HYDRA
CONDENSERS



Stringent testing of each individual unit at every stage of manufacture ensures the production of condensers that start accurate and stay accurate.

SOLE DISTRIBUTORS:

T.M.C.-HARWELL (SALES) Ltd
Britannia House, 233 Shaftesbury Avenue
London, W.C.2. (A few doors from New Oxford Street)

Telephone: Temple Bar 0055 (3 lines)

Made by TELEPHONE MANUFACTURING Co Ltd

ELIMINATORS and the £5 SUPERHET

Some Further Information Regarding the Operation of F. J. Camm's Battery Superhet Three in Conjunction with Commercial Eliminators



IT should be unnecessary to add to the information which was given last week concerning the use of mains units with the battery version of the three-valve Superhet. A large number of queries has been received concerning this method of operation, and the information which has already been given answers many of these. The few points which are outstanding concern principally the use of Class B or Q.P.P. output stages, and the question of instability.

Class B or Q.P.P.

Although it is a fairly simple matter to modify the output stage to take advantage of the Class B or double Q.P.P. valves, the question of a supply from the mains presents some little difficulty in view of the fluctuating current. There are, however, several good mains units already on the market which have been specially designed for use with this type of output circuit, and although some of these incorporate a neon stabilizer, the design of the remaining components in some of them has been arranged so that this particular component is not essential. If, therefore, an ordinary unit is already in the possession of a reader, and he desires to employ either the Class B or the Q.P.P. circuit, a neon stabilizer should be obtained and connected in accordance with the maker's instructions. Either of these methods of output will necessitate that the existing output valve be changed for a small power valve to act as a driver or feed for the double stage. Without this, the amplification will not do justice to the modification. Therefore, unless you are prepared to go to the expense of the extra stage, with the remaining modifications, the circuit should be put into use just as it was designed. It must be remembered that we cannot guarantee the receiver when it is modified, although in this particular case we have tried the circuit with the modified output and found that it is capable of really good results.

Decoupling

We mentioned last week that decoupling might have to be incorporated in the case of a unit which provides unstable results. Unless the unit is very old and of inferior design, no troubles of this nature will be encountered. It is as well, however, to bear in mind that should instability arise as soon as a mains unit is employed, and that such instability is absent when a battery is used, then the unit may be blamed. Therefore, if the receiver is built up and not tested with a battery, this should be the constructor's first concern in the event of instability. Obtain a good H.T. battery and connect it exactly as

FURTHER TRIBUTE

—One of hundreds already received

Sir,—It gives me very much pleasure as an engineer to compliment and congratulate you on having accomplished what hitherto all have proclaimed an impossibility, that of designing a superhet with a minimum of components and valves.

Having given this circuit an especial and very critical test in all phases, and from various points of view, I am committing myself when I say that this set is definitely worth further notice by keen constructors, of which "Practical Wireless" has a splendid following. Selectivity, tone, and H.T. consumption are all that could be desired in accord with Mr. Camm's claims. It is with mutual satisfaction that I state many of my clients have built and are building this epoch-making receiver.

The results are in no way proportional to the outlay, but far and above what one would expect for a £5 set. I concur with Mr. Camm in his choice of a W.B. speaker, one which personally I can highly commend to suit almost any type of output, and give exceptional satisfaction.

It is a privilege to state that "Practical Wireless" is a much sought-after paper in Bolton, whose constructors must be counted amongst the keenest and most capable in the country.

*Yours faithfully,
RONALD DAULBY,
Manager and Engineer
of Olympia Radio, Ltd.*

described in the constructional notes, and if instability ceases you will know for certain that the mains unit, and not the receiver, is at fault. Try only the addition of the resistances mentioned last week. No further modification to the circuit should be made, and therefore if this fails to effect a cure the mains unit should be tested for faults. In some of the older units it was customary to employ a potential divider across the output terminals, and this was tapped to provide the intermediate voltages. If the design of the potential-divider is sound, and a good large-capacity fixed condenser is joined between each tapping and earth, this should function quite well. Therefore, the first step in improving an old unit is to increase the capacity of the condensers

(if any are fitted) from the intermediate points to earth, or to remove them entirely and to employ only the maximum tapping. The size of the smoothing choke should also receive attention, and it may be found that this is too small for the particular receiver now in use.

A.C. Units

Remember that an A.C. unit carries a certain amount of raw alternating current, and therefore it is necessary to enclose the unit in a metal (iron) box and to earth it. If the unit now in use is not provided with an earth terminal, carefully examine the wiring and make certain there is no short before connecting an earth wire to it. If it is a D.C. unit, remember that the earth terminal on the receiver must be joined to earth only through a large capacity fixed condenser, so as to avoid the risk of short-circuiting the mains in the event of the mains plug being inserted the wrong way round. To avoid shocks the case should be earthed for protection.

Incorporating the Unit

The unit may be fitted on the shelf in place of the H.T. battery, or may be completely built up on the chassis after the manner of the A.C. receiver which is illustrated this week. The advantage of the latter method is that wiring is reduced in length and some convenience in construction is afforded, whilst the separate unit enables a change to be made at any time, and also gives provision for modifications to either receiver or mains section.

The leads up to the unit must be carefully arranged, in conjunction with the speaker and aerial-earth leads, in order to prevent interaction. It will be found in most cases that the mains leads and the loud-speaker leads may be run together, and they should preferably be twisted to form a cable, whilst the aerial and earth leads should be kept entirely separate and arranged at the opposite side of the complete equipment. If the aerial lead enters the room above the receiver it will no doubt be found advisable to permit the lead to hang very low, and then rise to the aerial terminal and not pass across the speaker leads to the terminal.

WANDER PLUGS FOR THE £5 SUPER-HET THREE

On page 211 of our issue dated October 27th last we illustrated the components which were employed in the battery receiver. Owing to an error the illustration of the wander plugs was given incorrectly. Will readers please note that the wander plugs and spades required for this receiver are of Belling-Lee manufacture.

FITTING A FUSE to the £5 3-Valve SUPERHET

How to Safeguard the Filaments of the Valves in the £5 Superhet Three

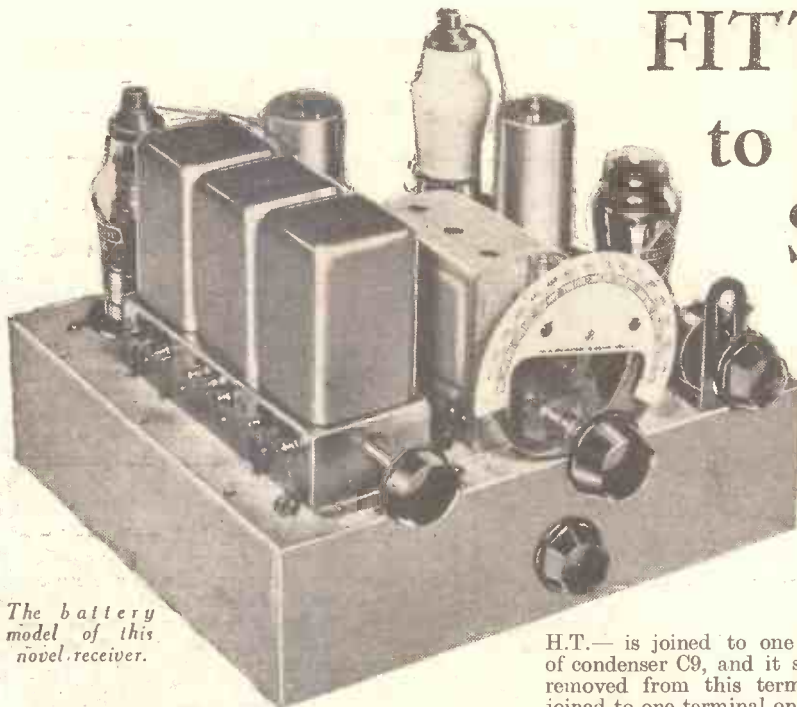

The battery model of this novel receiver.

A FUSE is felt by many readers to be a necessity in a battery-operated receiver, as there is always the risk that the battery leads may be dropped whilst making connections, with the result that a short circuit may be introduced and the high tension thereby brought into the filament circuit. With ordinary care this should not occur, but it is a simple matter to introduce a fuse in order to prevent an accident in the event of such a short circuit arising. The correct position for this is in the H.T. negative lead, and therefore it only remains to obtain the appropriate type of fuse and insert it in this lead. There are quite a number of different types from which to choose, and some of these are illustrated on this page. Probably the simplest type to employ is the Belling-Lee Wanderfuse, and this will be connected to the H.T. negative lead in place of the simple wander plug at present in that position. The Wanderfuse is a small bakelite holder, inside which is a tubular fuse, and the lead is joined to one end, in a similar manner to the normal plug, whilst the plug projects at right angles from the holder. Thus the complete Wanderfuse is no higher than the ordinary type of plug, and the insertion of the plug into the battery automatically brings the fuse into circuit. The component costs 1s., and is illustrated on this page.

As an alternative, one of the baseboard mounting holders may be employed, and the H.T. negative lead removed from its present position and joined through the fuse. On the under side of the chassis, it will be seen that condenser C9 is employed as an anchoring point for the lead in question. There is ample room at the side of this condenser for a fuse-holder, although it is possible that many constructors will

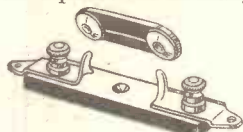

This is the Microfuse, a simple, easy-to-fix type of holder and fuse.

prefer to mount it on the upper surface of the chassis. In the latter case, two holes will have to be drilled at the side of the fuse-holder terminals.

H.T.— is joined to one terminal of condenser C9, and it should be removed from this terminal and joined to one terminal on the fuse-holder. The other terminal on the fuse-holder is then joined to the terminal on condenser C9 from which the negative lead was removed. In this manner the fuse is interposed in its correct position.

Choosing the Value of the Fuse

For the benefit of those who are purchasing a fuse separately, the following notes will enable them to select the correct value. The filament current of the pentagrid valve is .1 amp., whilst that of I.F. valve is the same. The pentode consumes .2 amps., so that the lowest rating in the receiver is 100 milliamps. In order to avoid damage to one of these valves, therefore, it is necessary to arrange that the fuse will be blown should the current rise to a value somewhat lower than 100 milli-

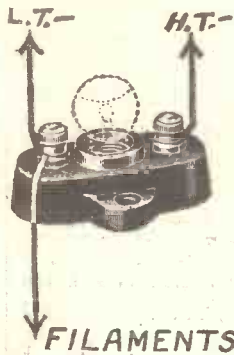

The connections of a fuse.

amps, and thus the fuse should have a value between 60 and 100 milliamps. This value will safeguard the receiver during experiments when it might be likely that two valves are removed from their sockets, and thus the more usual method of calculating the value of a fuse, by choosing a rating slightly lower than the total current of all valves, would not afford protection.

The question of surges due to condensers charging must, of course, be taken into consideration, but in this particular circuit it will be found that the above-mentioned values will be quite satisfactory in use with battery supplies, whilst when a mains unit is employed for H.T. a higher value will become necessary. Do not be tempted to use a flashlamp bulb for a fuse, as in general the rating is much too high and it will not provide any protection. The

standard fuses are designed to blow at 50 per cent. overload, but many of the cheap flashlamp bulbs will remain intact with considerably more than 100 per cent. overload, and thus valves will be damaged in spite of the inclusion of one of these lamps in the circuit.

Some Fuse Fallacies

There is undoubtedly a certain amount of confusion in the minds of home-constructors regarding this all-important point of the fuse, and this is no doubt a suitable time to discuss them. Upon examining any battery circuit it will be seen that, no matter what the circuit, the negative side of the high-tension battery is returned eventually to earth. The low-tension battery is also earthed, and thus the filaments are joined on one side to earth and on the other to the L.T. battery. The most usual circuit arrangement is for the negative L.T. to be earthed, and thus the H.T. positive lead must not be permitted to touch the L.T. positive wiring. Although it is difficult in many receivers for this to occur, the obvious safeguard is, as above-mentioned, to insert a fuse in the H.T. negative lead, so that a sudden rise in current above a safe value will cause the fuse to blow and thus break the high-tension circuit. The safe value is the point which causes the difficulty, as so many different statements may be made concerning it. As it is the filaments which are to be protected, it is obvious that the safe value is something lower than that which will cause damage to them. When all three valves in this receiver are in their holders the total current for the valves will be 400 milliamps, but the application of a high voltage to the filament circuit will cause a breakdown if it is sufficient to pass over 100 milliamps, as in that case one of the .1 amp. valves would blow. Thus it is necessary when arranging the fuse, first of all to consider the weakest link in the chain.

Sudden Surges

Unfortunately, however, there is the question of surges which arise when the circuit is completed or broken, and these depend upon the condensers which are arranged across the H.T. supply. Thus, if, in the above example, a very low value of fuse is employed, it may be found that every time the receiver is switched on or off the fuse will be blown.

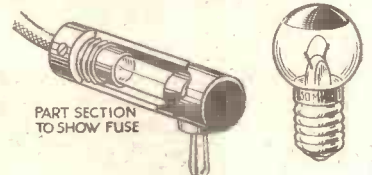

The Belling-Lee Wanderfuse and a standard fuse bulb.

FOR THE BEST RESULTS FROM
THE £5 3-VALVE SUPERHET



VARLEY 'PRACTICAL WIRELESS'
I.F. TRANSFORMER - - - - 7/3

Two of these Varley I.F. Transformers were specified by Mr. F. J. Camm for his "£5 Three-Valve Superhet." There are no alternatives. Use only Varley, and be sure of the best results!

FOREMOST AS PIONEERS



Bloomfield Road, Woolwich, London, S.E.18. Tel.: 2345

What this new "ATLAS" unit means
**TO EVERY
BATTERY SET OWNER**

Model T 10/30



6 OUTPUTS
10, 20 or 30 m/A
at 120 or 150v
CASH PRICE 69%

H. P. TERMS: 10/- deposit and 8 monthly payments of 8/6 each.
FOR A.C. MAINS, 100/125 or 200/250-v., 40/120 and 25 cycles.
H. T. TAPPINGS: 60/80-v., (min. and max.), 50/90-v. (min., med., and max.), 120-v. and 150-v.
6 OUTPUTS: 10, 20, or 30 m/A at either 120 or 150-v.
L.T. Trickle Charger. 2-v. at 0.5-A.
GUARANTEED 12 months. Westinghouse Rectifiers.
OTHER MODELS from 39/6. Cash, or 10/- deposit. Prices do not apply I.F.S.

This new "ATLAS" unit is quite unique. No other gives correct voltages for your present battery set—whether straight, superhet, "Class B" or "Q.P.P."—and also correct voltages

for any set you may own in the future. No other supplies such a huge reserve of power at so low a cost. Run your battery set from the mains with the "ATLAS T 10/30" and cut running costs to less than 1/- a year. Ask for a demonstration to-day.

FOLLOW THE EXPERTS—INSIST ON



H. CLARKE & CO. (M/CR.), LTD., Patricroft, MANCHESTER. London: Bush House, W.C.2. Glasgow: G.E.S. Co., Ltd., 38, Oswald St. I.F.S. D'strs. R. Marks, Ltd., 27, Upper Liffey St., Dublin.

© 19. a.

Send for this FREE folder now

Messrs. H. Clarke & Co. (M/CR.), Ltd., Patricroft, Manchester. Please send me Folder No. 95, telling me how to run my battery set from the mains.

Name
Address
01/10

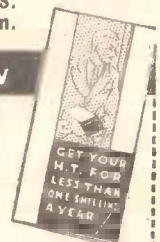

Every set a SHORT WAVE set

with the **BRITISH GENERAL**
ALL WAVE TUNER

This famous coil, covering all wave lengths from 14.5 to 2,000 metres, still remains the most successful of all all-wave tuners.

Its remarkable popularity is due to the superb workmanship, reasonable price and, above all, its unequalled efficiency.

Easy fixing and simple tuning.

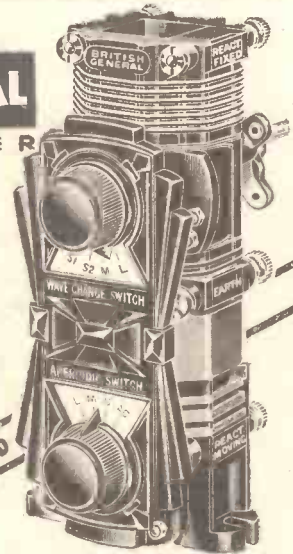

FREE WIRING DIAGRAM SUPPLIED

9/6

British General Manufacturing Co., Ltd.,
Brockley Works, London, S.E.4.
Telephone: Lee Green 5055.

From all dealers or direct.

Note this EDGE-ON ANODE

BATTERY SG2 7/6

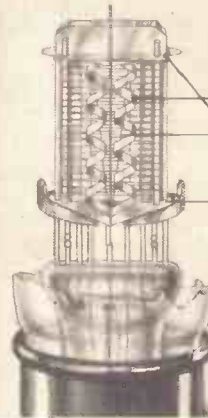

"Edge-on" anodes, minimising interelectrode capacity. Uniquely sprung long life filament of unusually sturdy construction. All parts completely interlocked, eliminating microphony.

It means exceptional

PERFORMANCE

362 VALVES

THE 362 RADIO VALVE CO. LTD.
STONEHAM RD, LONDON, E.5.

THE patent design of the anode of the 362 Battery SG2 provides exceptionally small interelectrode capacity owing to their "edge-on" construction. This valve has an unusually long straight portion to its characteristic, and can therefore be particularly recommended for a last S.G. stage. **ALL 362 VALVES ARE GUARANTEED FOR 6 MONTHS. IF NOT STOCKED BY LOCAL DEALER SEND P.O. DIRECT TO US.** "362" PRICES: BATTERY VALVES—H, HL & L 3/6, Power 4/-, Super Power 4/6, SG & VS 7/6, Pentode Type 10/-, BA & BX 9/-. "362" A.C. MAINS—AC HL4 7/6, AC PX4 9/-, AC SG4 & AC VS4 12/6, AC ME & AC HM 13/-, RB41 7/6, RB42 10/-. E

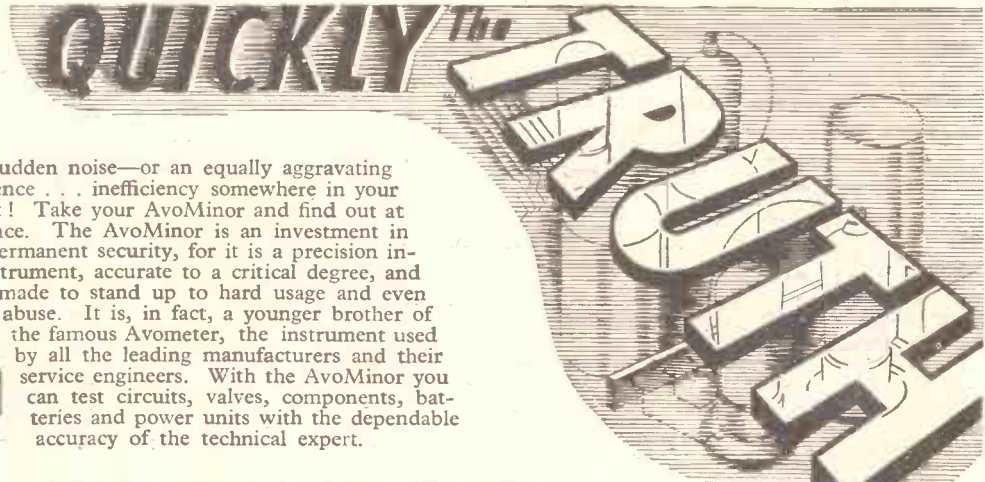

A sudden noise—or an equally aggravating silence . . . inefficiency somewhere in your set! Take your AvoMinor and find out at once. The AvoMinor is an investment in permanent security, for it is a precision instrument, accurate to a critical degree, and made to stand up to hard usage and even abuse. It is, in fact, a younger brother of the famous Avometer, the instrument used by all the leading manufacturers and their service engineers. With the AvoMinor you can test circuits, valves, components, batteries and power units with the dependable accuracy of the technical expert.

There is no substitute for the AvoMinor. It is a moving coil combination testing meter—ten accurate instruments in one. Supplied in convenient case with leads and interchangeable testing prods and crocodile clips, and complete instruction booklet adequately illustrated.

Fully descriptive Folder post free from:—

THE AUTOMATIC COIL WINDER & ELECTRICAL EQUIPMENT CO., LTD.
Winder House, Douglas Street, London, S.W.1. Telephone: Vic. 3404/7

TEN ACCURATE METERS IN ONE

- | | |
|-----------------|----------------|
| CURRENT | VOLTAGE |
| ● 0-6 milliamps | ● 0-6 volts |
| ● 0-30 " | ● 0-120 " |
| ● 0-120 " | ● 0-300 " |

- | | |
|-------------------|-----------------|
| RESISTANCE | |
| ● 0-10,000 ohms | ● 0-60,000 ohms |
| ● 0-1,200,000 " | ● 0-3 megohms |

40! Size 4" x 3" x 1 1/2"
Total Resistance: 100,000 ohms.
Full scale deflection on 3 milliamps.

Deferred Terms if desired.

THE D.C. AVOMINOR

REGD. TRADE MARK

TELLS THE WHOLE TRUTH

"RADIO SERVICING SIMPLIFIED"
Everyone should have this invaluable new book. It explains every phase of fault-tracing step by step in non-technical language. The comprehensive make testing a matter of straight-forward procedure.
2/6 post free 2/9

ADDING A.V.C. and a GRAMOPHONE PICK-UP to F. J. Camm's £5 3-Valve Superhet

Some Details Regarding the Provision of Automatic Volume Control and the Fitting of a Pick-up to This Novel Receiver

and it is possible to obtain plugs to fit, it is not a difficult matter to fit the pick-up leads with the plugs and then plug in the pick-up when gramophone record reproduction is required. Experiment will show

and although this voltage is not very great it is sufficient to act upon the pentagrid and the I.F. valve and provide a small measure of control, assisted by the manual control R3. This is, of course, A.V.C. in its very simplest form, and there is no delay voltage or amplification afforded, but where a small degree of fading is noticed on a fairly good distant station, it will probably be found that this improvement is worth while. The connections are clearly indicated in Fig. 2, and no difficulty should be experienced in making the change.

Separate A.V.C.

It would, of course, be possible to arrange for another Westector to perform the function of complete volume-control, and in that case a delay voltage could be provided. The circuit would, however, have to be rather drastically modified to carry out this alteration, and the full advantages of the alteration would not be experienced unless a preliminary H.F. stage were included before the pentagrid.

whether the particular pick-up which you have is suitable for permanent connection, and a weak station should be tuned in without the pick-up connected, and then when maximum volume has been obtained, the pick-up should be connected. If there is no appreciable loss of volume, then it may be left permanently connected, and no further alteration will be required when changing over from radio to gramophone.

Automatic Volume Control

Many readers wrote concerning the application of A.V.C. to the circuit, and it was felt desirable that the feature should be included for the benefit of those who require it. Obviously, where such a small amount of H.F. amplification is being used, the degree of control which can be effected is not very great, but there are a number of situations where fading is only slight, and even a small degree of automatic control will enable a signal to be held. Obviously a complete A.V.C. unit could be used, but experiments were again made to determine whether the circuit could not be modified without further expense. A scheme which was finally found to perform quite well is depicted in Fig. 2. Here it will be seen that the resistance R2 is changed in value from 30,000 ohms to 250,000 ohms, but beyond this no further modification is required. It will now be seen that part of the rectified voltage developed across the Westector is now fed to the volume control circuit formed by the potentiometer R3 and the decoupling resistance R2,

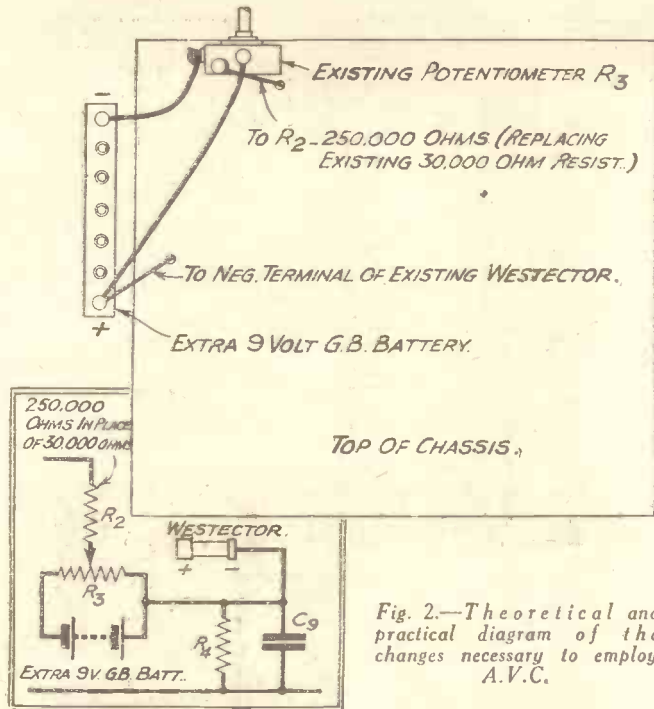

Fig. 2.—Theoretical and practical diagram of the changes necessary to employ A.V.C.

AS we pointed out last week, many hundreds of letters were received from readers concerning the use of a gramophone pick-up with the £5 Superhet Three, and we gave brief notes last week showing how it was possible to use the pick-up with the last stage only. In an ordinary receiver, where the detector is a valve, or where more than one L.F. stage is employed, it is quite a simple matter to connect the pick-up in the grid circuit of either the detector or the L.F. stage and thus obtain good amplification. In this receiver, however, we have a Westector performing the function of second detection, and this is followed by a pentode output stage. Thus the only place where the pick-up can be connected is after the Westector. Last week we explained that by connecting one side of the pick-up to the grid of the pentode valve and the other to the biasing lead, it was possible to obtain good quality signals, although it is necessary to employ a pick-up with a rather large output in order to obtain signals of any volume.

A Step-up

Since the publication of those notes, however, some experiments have been carried out in order to find some method which would give louder signals and yet not interfere with the performance of the receiver on the radio side. Various ingenious schemes were tried, and some novel circuit arrangements were devised. Finally, however, it was found that by joining the pick-up to the primary of the L.F. transformer, sufficient amplification was obtained to enable any ordinary type of pick-up to be used, and yet the radio performance was not modified in the slightest. Furthermore, no extra parts are required, and it is only necessary to connect two leads to the pick-up terminals and join these to the terminals on the Max transformer marked 1 and 3. Fig. 1 explains the scheme clearly. In the case of a large number of pick-ups it was found possible to leave them permanently connected. However, as sockets are used for connecting purposes,

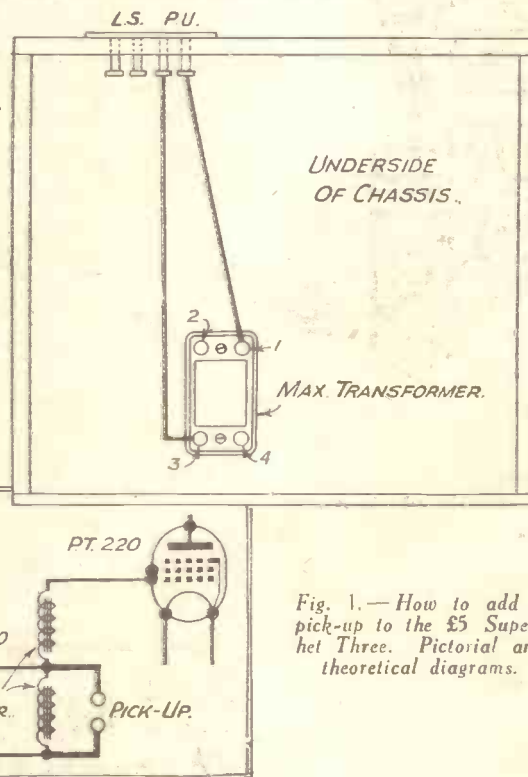
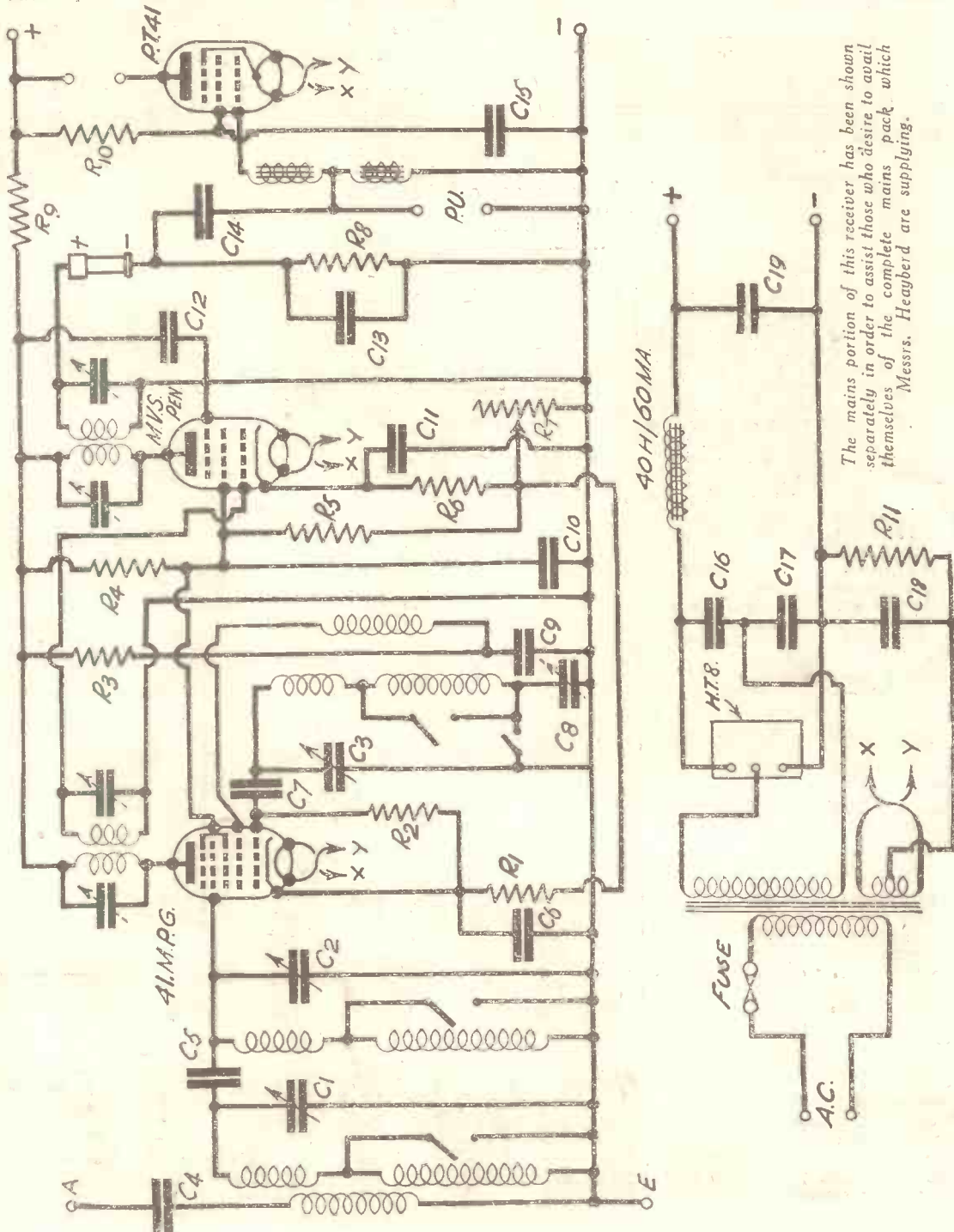

Fig. 1.—How to add a pick-up to the £5 Superhet Three. Pictorial and theoretical diagrams.

THE A.C. SUPERHET THREE



The mains portion of this receiver has been shown separately in order to assist those who desire to avail themselves of the complete mains pack which Messrs. Heyberd are supplying.

LIST OF COMPONENTS.

- One Set 3-gang Superhet Coils, type W.476 (Telsen).
- One 3-gang Superhet Midset Variable Condenser, type 2124B, and Disc Drive U. B.).
- Two "Practical Wireless" I.F. Transformers (110 kc/s) (Varley)
- One 3.5:1 L.F. Transformer (B. T. S.).
- One .002 mid. Formodenser, type H (C.8) (Formo).
- One 2,500 ohm Potentiometer (R.7) (Varley).
- 12 Fixed Condensers, .0003 mfd., type M (C4), .0001 mfd. (C7), type M, .0001 mfd., type M (C13), 4.1 mfd., type 250, 5 mfd., type 50, 5 mfd., type 50 (C14), 2 mfd., type 84 (C15), 1 mfd., type 84 (C12), 4 mfd., type 84 (C19), 25 mfd. Electrolytic, type 511 (C18) (T. C. C.).
- One L.F. Choke, 40 hy. 60 ma. (B. T. S.).
- Seven 1 watt Fixed Resistances, 100,000 (R2), 20,000 (R3), 30,000 (R5), 20,000 (R4), 100,000 (R8), 5,000 (R10), 3,000 (R9) (Ferranti).
- One 2 watt Fixed Resistance, 350 ohms (R1) (Dubilier).
- Two 1 watt Fixed Resistances, 100 ohm (R1) and 150 ohms (R6) (Dubilier).
- One Potentiometer Bracket (Peto Scott).
- One Westector, type W6 (Westinghouse).
- One Mains on/off Switch (Becker).
- One 1 amp. Fuse (Microfuse).
- Two 7-pin sub-baseboard Valveholders (Clix).
- One 5-pin ditto (Clix).
- One A/E Socket Strip (Clix).
- One L.S. Socket Strip (Clix).
- One Mains Unit, type P.P. (Heyberd). Includes: Westinghouse H.T. Rectifier. Mains Transformer. Two 4 mfd. Condensers.
- One Metaplex Chassis (Peto-Scott).
- One Mains Connector (Clix).
- Three Valves, 4IMP.G, MVS-Pen., PT41 (Cosor).
- One PMS.1 Stentorian Senior Moving-Coil Loud-speaker (W. B.).



6^d

On sale at all Newsagents,
Bookstalls and Dealers, or
by post 7½d. from George
Newnes, Ltd., 8-11, South-
ampton St., Strand, London,
W.C.2.

THE December issue of this intensely interesting monthly deals in everyday language with the latest ideas in this newest of all sciences. Easily understood articles include: "What is Television Definition?" "Television Distortion," "Relaying Television Signals," "High Definition Television," "Television and the Amateur," "Linking Radio and Television Receivers," "A Universal A.C.-D.C. Amplifier," "Making Scanning Discs," "Modulating Bright Light Sources," "The Light Microphone of Television," "Neon Lamps for Television," "An A B C of Television," etc. There are also topical reflections from the radio screen and pars about the persons and programmes.

PRACTICAL TELEVISION

THE A.C. THREE SUPERHET

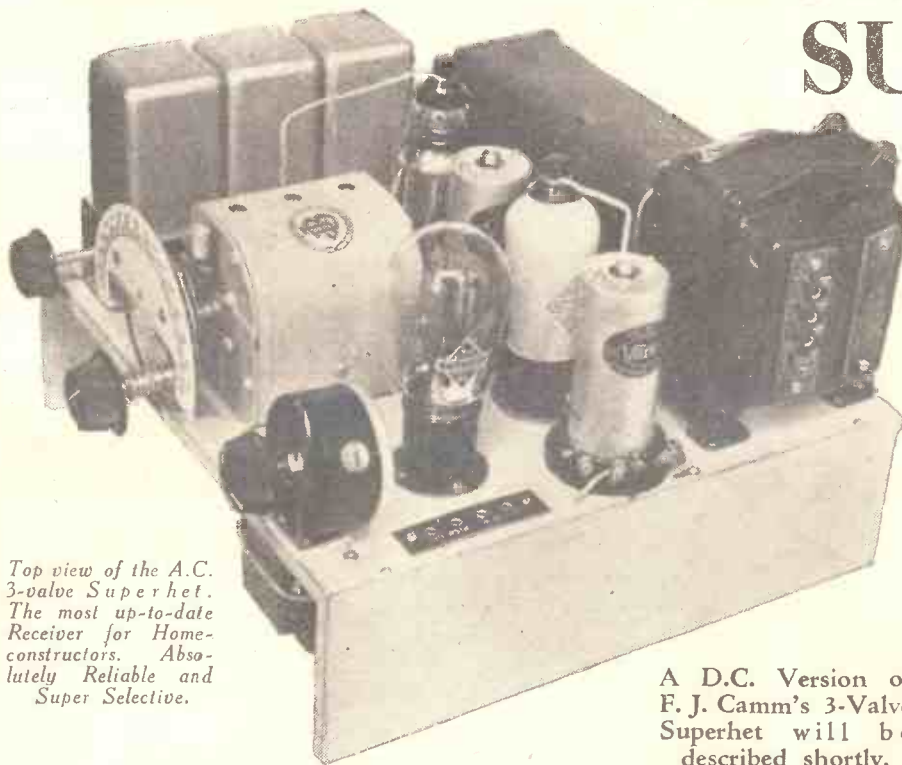

Top view of the A.C. 3-valve Superhet. The most up-to-date Receiver for Home-constructors. Absolutely Reliable and Super Selective.

A D.C. Version of F. J. Camm's 3-Valve Superhet will be described shortly.

THERE is no doubt that the feature of using the superheterodyne principle in a small receiver has immense possibilities. The vast correspondence which has been received by us, not only from readers, but also from technical students and radio manufacturers, shows that there is definitely a demand for a receiver of the type of the £5 Superhet Three. Accordingly we have decided that it is in the interests of the home-constructor to describe the construction of mains versions of this receiver, and this week we are introducing the model designed for use on alternating-current mains. The theoretical circuit is reproduced, together with a complete list of the components required, on page 324. An examination of this will reveal that the original design has been retained, with the modification only of those parts which are rendered essential owing to the difference in the valves and the nature of the voltage supplies.

The Circuit

Thus it will be seen that there are still only three valves, the pentagrid, the variable-mu I.F., and the output pentode valve. The first valve performs the combined function of frequency changing and first detection; the second acts as a pure amplifier, and both of these valves are of the variable-mu type and thus are arranged in such a manner that the applied bias may be varied. The valves are of the indirectly-heated type, and thus the cathodes are connected to the arm of a

potentiometer through decoupling resistances, these serving to prevent instability and interaction. To supply the voltage for the screening grids of these two valves a fixed potentiometer is connected across the total H.T. supply, and this is completed through the volume control potentiometer, thus providing very smooth control. The values and methods of connection have been chosen so that there is no possibility of the screen voltage rising to a high value, and thus safety is assured in addition to complete stability.

The Westector is again employed for second detection, and it will be noticed that the output from this is again fed into an auto-transformer. Connections for the gramophone pick-up are provided across the primary of this transformer, and, as we mention on another page, this provides very good signal strength when a good pick-up is employed, and removes one of the difficulties of obtaining satisfactory record reproduction when only a single L.F. valve is employed.

Two-and-a-half Watts Output

The output pentode is rated to deliver an undistorted output of approximately $2\frac{1}{2}$ watts, the actual figure being just over 2,600 milliwatts. Thus ample volume is afforded on the majority of signals. This valve is of the directly-heated type, and to provide automatic bias the necessary resistance is joined between the centre-tap of the common heater winding and H.T.—

The Mains Section

It will be noticed in the circuit diagram that the mains section is illustrated separately, and in the actual receiver it will be seen that this, in fact, built upon the same chassis as the receiver, and the set is thus entirely self-contained. For the benefit of those readers who prefer to use a separate unit, however, Messrs. Heyberd have agreed to supply a complete unit, in which the mains transformer, the metal rectifier, and the two smoothing condensers C16 and C17 are incorporated. This is all built into a neat metal cabinet and represents a saving to the constructor, costing only 44/-. It will have to be mounted on a shelf with the loud-speaker and leads taken down to the receiver. The advantage of using a separate unit is that at any time when it is desired to make a change in receiver design, the mains portion is already for use and may thus be adapted without further expense. The total voltage output from the H.T.8 is in the neighbourhood of 250 volts and this is applied direct, after a slight drop through the smoothing choke, to the anode circuit of the pentode valve. The remaining two valves require a slightly lower voltage, and therefore a dropping resistance, R9, is inserted in the H.T. positive lead. The anodes of these valves are not decoupled, as this has been found unnecessary, but the remaining H.T. circuits are arranged with decoupling components to prevent instability. Protection to the complete

apparatus is afforded by means of a fuse in the primary circuit of the mains transformer, and this is a

Microfuse, the actual resistance element being easily replaced in the event of damage.

Thousands are already building this astonishingly simple receiver.

The Layout

Certain points of interest may be found in the complete layout, the first being the rather unusual method of arranging the aerial and earth and loud-speaker socket strips. The latter is mounted on the upper surface of the chassis, and is not in the more usual position at the rear edge. This enables more direct wiring to be carried out, and removes the possibility of instability. The metal rectifier is on the rear edge, well away from components which might be damaged

THE MOST INGENUOUS RECEIVER OF THE DECADE!

3-VALVE

Final Details of the A.C. Version of the Popular £5 Battery Receiver Employing a Minimum of Valves

should undue heating arise. It is well to bear in mind that the back of the cabinet should not be completely closed, in order to permit of adequate ventilation for the rectifier. The remainder of the layout needs no comment, and construction should be found extremely straightforward.

So far as actual constructional work is concerned there is nothing difficult or which needs lengthy explanation. Those readers who are used to home-construction will be able to go ahead with the circuit diagram and wiring diagrams published in this issue and will thus be able to complete the receiver in quite a short time. For the benefit of those who are not used to the construction of receivers except, perhaps, the more simple types, we shall give next week some complete details and hints, together with stage-by-stage wiring instructions.

If you intend to construct the receiver exactly as shown in the diagrams on the right, you will have to obtain the mains transformer, the metal rectifier and condensers C17 and C18 as separate units. If, however, you desire to save yourself the trouble of wiring this part of the receiver, or desire to employ the separate method of building up a unit as a complete mains pack, you may purchase the special Unit made up by Messrs. Heyberd as stated in a previous column.

Remember that the added efficiency of the mains valves will make this version of the three-valve superhet even more remarkable in its performance than the battery receiver.

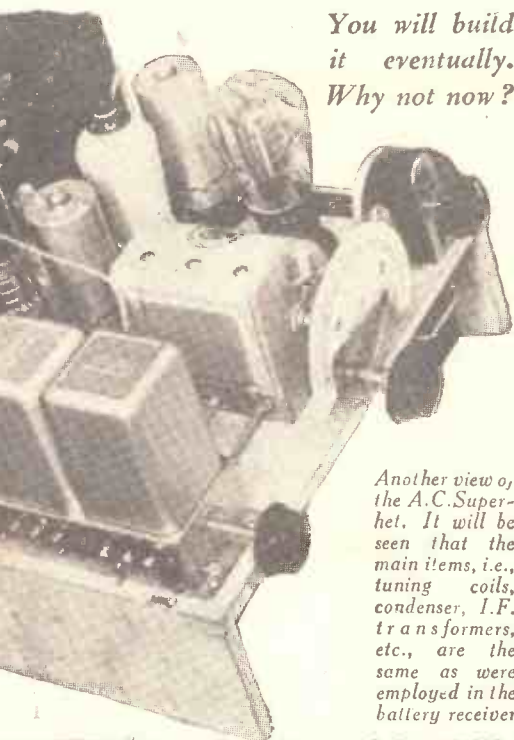

You will build it eventually. Why not now?

Another view of the A.C. Superhet. It will be seen that the main items, i.e., tuning coils, condenser, I.F. transformers, etc., are the same as were employed in the battery receiver

3 VALVES-5 STAGES!

TOP AND SUB-CHASSIS WIRING DIAGRAMS OF THE A.C. 3-VALVE SUPERHET.

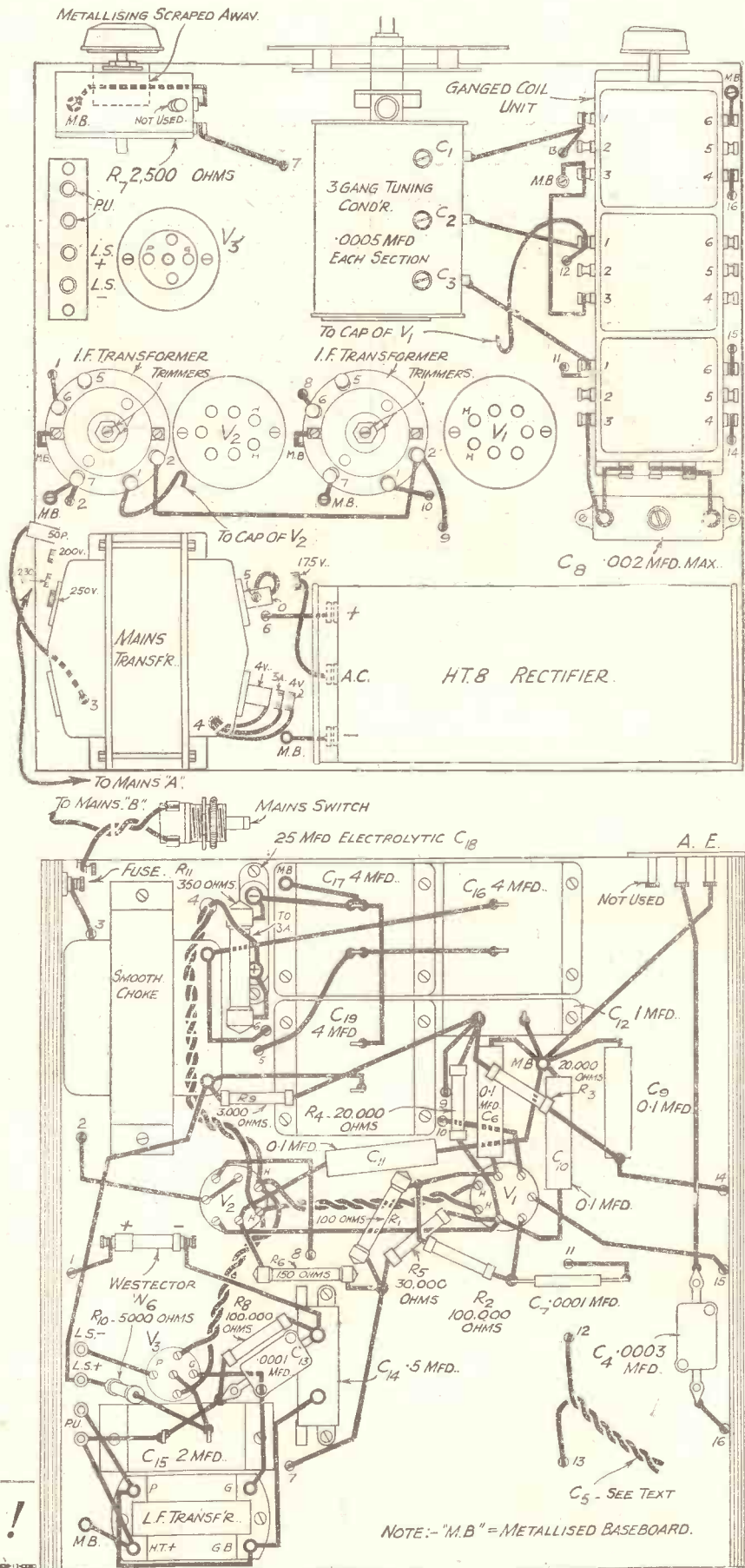

AMATEUR TELEVISION

SYNCHRONIZING HINTS

By H. J. BARTON CHAPPLE, B.Sc., A.M.I.E.E.

THE use of some form of synchronizing, either manual or automatic, when receiving and watching a television image is advisable if the maximum enjoyment is to be secured from the programme radiated. As a general rule, no matter what form of manual synchronizing is used, that is whether simple pressure on the driving motor shaft (and, eddy current brake, or spring tension, etc., the electrical character of the image is unaltered, the control simply being an aid to keep the image steady within the viewing frame.

With the popular form of cogged wheel automatic synchronizing, however, disappointing results will accrue unless careful attention is directed towards one or two important points. First of all, the best size for the cogwheel is 2in. outside diameter and 3/4in. thick, the whole wheel being made up from thin, soft iron stampings. There are thirty teeth or cogs in the wheel, and the ratio of the tooth width to gap between teeth is one to four. This form of synchronizing device is in no way a drive such as a phonic wheel where equal gap and tooth width is required, and an adherence to the ratio stated, or within a close approximation of this figure, will ensure correct magnetic flux distribution.

Mounted on the motor carcass or on a separate bracket, whichever is most convenient, is the cast-iron framework embracing the wheel, the two extensions each holding one adjustable pole piece with a pole face 1/2in. wide and the same thickness as the wheel tooth. It is essential for these pole pieces to be set at diametrically opposite sides of the toothed wheel, and lined up in such a way that a straight line will pass from pole tip centre to tooth centre right through the centre of the cogwheel

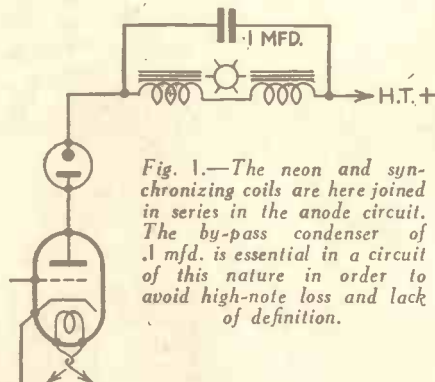

Fig. 1.—The neon and synchronizing coils are here joined in series in the anode circuit. The by-pass condenser of .1 mfd. is essential in a circuit of this nature in order to avoid high-note loss and lack of definition.

to the opposite tooth and pole tip centre. Furthermore, the gap between pole tip and tooth face should not exceed .006in., and in consequence this calls for an absolutely true running motor shaft on which the cogwheel is mounted. Any tendency to whip or a loose fit of the wheel boss on the shaft, giving an eccentric motion when fixing is carried out by a single grub screw, will necessitate a wide flux gap, and the resulting magnetic synchronizing pull will be rendered almost useless.

Synchronizing Gear Coils

The field coils, one being slipped over each pole piece, must provide sufficient magnetic flux with the normal polarizing current passed through them when the windings are joined in series. Various turns can be used with different gauge wires, but a suitable coil is 5,000 turns of No. 37 s.w.g. enamelled wire. This should be suitably

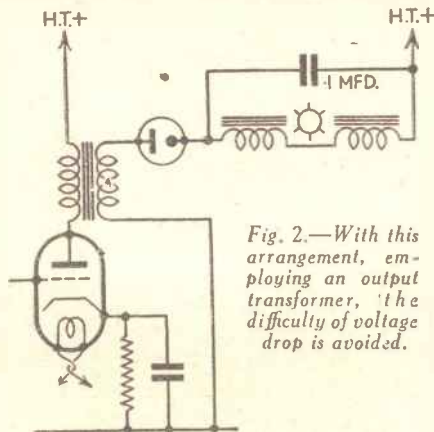

Fig. 2.—With this arrangement, employing an output transformer, the difficulty of voltage drop is avoided.

insulated with Empire tape or other material to stand a potential of 600 volts to frame without breakdown. The windings are joined in series to make one pole tip positive and the other negative, and in addition it must be ensured that the coils have no electric or magnetic connection with the motor winding.

With all these points attended to, the incoming radio television signal, which has superimposed upon it the synchronizing pulses of 375 per second, when passed through the coil windings will bring about a strong pull on the wheel, tending to maintain it at the correct running speed of 750 revolutions per minute. What is likely to happen, however, is that the image, when compared with that obtained when no synchronizing equipment was included in the receiver, is definitely inferior.

A Useful H.F. Choke

Usually the coils are joined in series with the neon lamp in the case, say, of a disc machine as indicated in Figs. 1 and 2, and they will at once introduce into this section of the circuit a high impedance owing to the inductive reactance of the two coils. This forms an effective choke to the high frequencies which are so essential to impart detail to the image, and hence the poor quality results. To overcome this an ordinary paper insulation type 0.1 mfd. capacity condenser rated at 250 volts working should be connected across the pair of coils as shown in Figs. 1 and 2. This will act as an effective high-frequency bypass, and restore the image to its former quality. It is surprising how often this condenser is omitted in home constructed apparatus, and the importance of its inclusion cannot be stressed too strongly.

TELEVISION POSSIBILITIES

THERE is no doubt that the police could find many uses for television if the various stations were linked up with headquarters by wire or by wireless. Photographs of wanted criminals, missing persons, articles, etc., could be shown to all the constables immediately, and thus expedite the work of the force. Again, stage managers could conduct their auditions by television, and so draw up a "short" list very quickly without actually seeing the artists personally. Occasions occur quite frequently when newspaper editors or reporters will find an added value in interviewing various people when television can be called in as an aid, for when preparing the story the reaction of the person to the various questions which are put to him can be seen, and a truer complexion given to the published details. Many other schemes could be dealt with, but enough has been said to show that when the time is ripe, television will have an extremely important commercial value, quite apart from its use in providing entertainment, either in the home or in theatres and cinemas.

D.C. MAINS HUM

THE matter of smoothing concerns the television experimenter even more than the broadcast experimenter.

It is very easy to understand that any set running from D.C. mains will probably have a "mains hum" unless special precautions are taken. When current is supplied from a big generator, as opposed to an electric cell, it is naturally alternating; by increasing the number of field coils an approximation to direct current is obtained, but even in the best of cases there still remains a ripple. That is, the voltage does not remain absolutely steady, and the ripple tends to cause hum. In places such as East Ham and Leytonstone the electricity is supplied as pure alternating, and is "rectified" by means of a mercury-arc rectifier, which means that half the negative volts are dropped and the other half taken. With mercury-arc rectified "D.C." current we really have almost half A.C., and no wonder there is a hum. Luckily there is a fairly easy cure, but unfortunately not for all cases.

The most certain cure is made with two large capacity condensers and two large capacity H.F. chokes. The condensers should be about 2 microfarads each, and the chokes of as high inductance as is consistent with a resistance which will not interfere

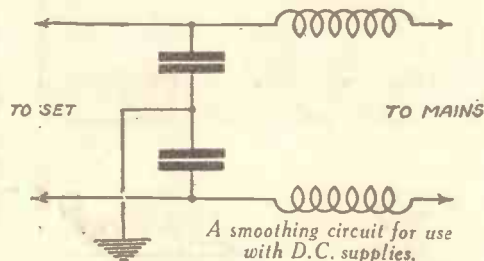

too much with the voltage necessary to run the set. Another important fact is to use a "centre-point" earth as shown in the accompanying diagram.

SELECTED EASIWAY ITEMS

BLUE SPOT "STAR" JUNIOR P.M. MOVING-COIL SPEAKER

With 12-point matching transformer suitable for all outputs.

Send only 2/6, balance in 9 monthly payments of 4/-. Cash or C.O.D. Carriage paid, £1/15/0.



TELSEN S.G.3. KIT, less valves. Cash or C.O.D. Carriage Paid, £1/19/6. Balance in 8 monthly payments of 5/-. If valves required add £1/11/6 to Cash Price; H.P., 6/- Deposit and 11 monthly payments of 6/6.

LISSEN SKYSCRAPER 4 KIT ALL WAVE KIT

Complete Kit comprises all components, including set of Lissen Valves. Send only 10/-, balance in 11 monthly payments of 10/3. Cash or C.O.D. Carriage Paid, £5/12/6.



BLUE-SPOT "STAR" MOVING-COIL SPEAKER. Send Complete with Universal matching Transformer. Cash or C.O.D. Carriage Paid, £3/10/0. Balance in 11 monthly payments of 6/6.

Peto-Scott Guaranteed H.T. ELIMINATORS

For A.C. Mains. 200/250 volts. 3 Tappings: S.G. 60v., Detector 80v., Power 120-150v. Output 25 m/a. Incorporates Westinghouse rectifier. Send only 2/6, balance in 9 monthly payments of 4/-. Cash or C.O.D. Carriage Paid £1 15s 0d. D.C. Model for D.C. Mains only. Similar specification, but without rectifier. Cash or C.O.D. Carriage Paid, 17/6 or 2/6 deposit and 7 monthly payments of 2/6.



COLVERN COLPAK TUNING UNIT. Incorporates the famous Ferrocart coils. Cash or C.O.D. Carriage Paid, £2/17/6. Balance in 11 monthly payments of 5/3.

BLOCK H.T. ACCUMULATORS

PLATELESS. -2.60 volts, 5,000 m.a., light, portable units in bakelite case. Send only 6/- for the pair; balance in 11 monthly payments of 7/-. Cash or C.O.D. Carriage Paid, £3/15/0.

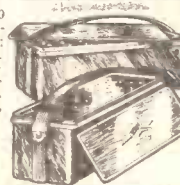

ATLAS D.C. 15/25B. 200-250 v., D.C. Suitable for Class "B" and Q.P.P. outputs. Three tappings: 10, 20 or 30 m.a. at 120/150 volts. Trickle charger incorporated, 2 volts .5 amp. Send only 5/-; balance in 12 monthly payments of 6/-. Cash or C.O.D. Carriage Paid, £3/9/6.

ATLAS ELIMINATOR

Model T10/30. For Class B and Q.P.P. A.C. 200/250 volts, 40/120 cycles. Three tappings: 10, 20 or 30 m.a. at 120/150 volts. Trickle charger incorporated, 2 volts .5 amp. Send only 5/-; balance in 12 monthly payments of 6/-. Cash or C.O.D. Carriage Paid, £3/9/6.



PETO-SCOTT

PILOT AUTHOR KIT EXACT TO SPECIFICATION

SEND US YOUR ENQUIRIES FOR EVERYTHING RADIO... Miscellaneous Components, Parts, Kits, Finished Receivers or Accessories for Cash or C.O.D. or H.P. on our system of Easy Payments. Send us a list of your wants. We will quote you by return. C.O.D. orders value over 10/- sent carriage and post charges paid (GREAT BRITAIN ONLY). Any surplus refunded immediately. Hire Purchase Terms are NOT available to Irish and Overseas customers.

F. J. CAMM'S £5 3-VALVE SUPERHET

BATTERY VERSION KIT "A" CASH OR C.O.D. £5:0:0 CARRIAGE PAID. OR YOURS FOR 9/-

Author's Kit of first specified parts including Metaplex chassis, less Valves and Cabinet. Cash or C.O.D. Carriage Paid, £5/0/0.

KIT "B" As for Kit "A" but including set of specified Valves, less cabinet. Cash or C.O.D. Carriage paid, £7 5s 6d. or Yours for 13/3 and 11 monthly payments of 13/3.

KIT "C" As for Kit "A" but including valves and Peto-Scott Walnut Console Cabinet, less speaker. Cash or C.O.D. Carriage paid, £9 0s 6d. or Yours for 16/6 and 11 monthly payments of 16/6.

A.C. VERSION KIT "A" CASH OR C.O.D. £7:5:0 CARRIAGE PAID. OR YOURS FOR 13/3

Author's Kit of first specified parts including Metaplex chassis, less Heyberd Mains Unit, Valves, Cabinet and Speaker. Cash or C.O.D. Carriage Paid, £7 5s. 0d. or Yours for 13/3 and 11 monthly payments of 13/3.

KIT "B" As for Kit "A" but including set of specified Valves, less Heyberd Mains Unit, Cabinet and Speaker. Cash or C.O.D. Carriage paid, £10 1s. 0d. or Yours for 18s. 6d. and 11 monthly payments of 18/6.

KIT "C" As for Kit "A" but including valves and Peto-Scott Walnut Console Cabinet, less Heyberd Mains Unit and speaker. Cash or C.O.D. Carriage paid, £12 1s. 0d. or Yours for 22/- and 11 monthly payments of 22/-.

If W.B. Stentorian Standard Speaker required with any of above Kits, add £1/12/6 to Cash or C.O.D. Prices or 3/- to each monthly payment.

CHASSIS AS SPECIFIED

by Mr. F. J. Camm. Metaplex Chassis, size 11in. by 10in. by 2 1/2in., as specified. Cash or C.O.D. Postage 6d. extra.



CHASSIS AS SPECIFIED

by Mr. F. J. Camm. Metaplex Chassis, size 12in. by 12in. by 2 1/2in., as specified. Cash or C.O.D. Postage 6d. extra.

KIT-BITS You pay the postman. We pay Post charges on all orders over 10/-. Great Britain only.

- 1 Peto-Scott Walnut Console Cabinet .. £1 15 0
- 1 Telsen 3-gang superhet coils, type W.476 .. 1 10 0
- 1 J.B. 3-gang, type 2124B and disc drive .. 19 9
- 2 Varley I.P. transformers .. 14 6
- 1 Westinghouse Westector .. 7 6
- 1 set of 3 Specified Valves .. 2 5 6

KIT-BITS You pay the Postman. We pay Post charges on all orders over 10/-. Great Britain only.

- 1 Peto-Scott Walnut Console Cabinet .. £2 0 0
- 1 B.T.S. L.F. Transformer .. 4 6
- 1 B.T.S. L.F. Choke .. 10 6
- 1 Telsen set of Superhet Coils, Type 476 .. 1 10 0
- 1 J.B. 3-gang Condenser, with drive .. 19 9
- 1 set of 3 Specified Valves .. 2 16 0

HEYBERD MAINS UNIT Specified A.C. VERSION YOURS FOR 5/-

Practical Power-pack, specially designed for Mr. F. J. Camm's £5 3-Valve Superhet. Output 200-250 volts; 40-60 m.a. L.T. 4 volts. 3 amps. Centre tapped. Cash or C.O.D. Carriage Paid, £2/4/0, or yours for 5/-; balance in 9 monthly payments of 5/-.

ANY ITEM SUPPLIED SEPARATELY—ORDERS OVER 10/- SENT C.O.D. CARRIAGE AND POST CHARGES PAID

W.B. STENTORIAN STANDARD BERMAN ENT-MAGNET M.C. SPEAKER. For Power, Pentode, and Class B. Cash or C.O.D. Carriage Paid, £1/12/6. Send only 2/6. Balance in 11 monthly payments of 3/-.

W.B. STENTORIAN SENIOR PERMANENT MAGNET M.C. SPEAKER. For Power, Pentode, and Class B. Cash or C.O.D. Carriage Paid, £2 2/0. Send only 2/6. Balance in 11 monthly payments of 4/-.

W.B. STENTORIAN BABY PERMANENT-MAGNET M.C. SPEAKER. With matching transformer, suitable for Power, Pentode, Class B or Q.P.P. Cash or C.O.D. Carriage Paid, £1/2/6. Send only 2/6. Balance in 9 monthly payments of 2/6.

DROITWICH BAND CONTROL COILS

Receive Radio-Paris without interference from Droitwich with these amazing new coils. This high degree of selectivity results from the NEW WAVE WINDING, now offered the Home Constructor for the first time. Interchangeable for aerial or anode circuits. 1 pair B.T.S. Droitwich Band Control Coils 7/- Part Post and packing 6d. extra.

GRAHAM FARISH RAIDER 3 KIT

Complete Kit of parts for building, less Valves and Cabinet, Cash or C.O.D. Carriage Paid, £3/7/6. Yours 5/- and 11 monthly payments of 6/3. If required with specified Valves, B.R.G. Cabinet, and W.B. Baby Stentorian Speaker, Cash or C.O.D., Carriage Paid, £7/6/6, or deposit 3/6 and 11 monthly payments of 13/6.

PETO-SCOTT CO. LTD. 77, CITY ROAD, LONDON, E.C.1. Telephone: Clerkenwell 9406/7. West End Showrooms: 69 High Holborn, London, W.C.1 Telephone: Holborn 3248.

Dear Sirs,—Please send me CASH/C.O.D./H.P.

.....

for which I enclose £..... s..... d. CASH/H.P./DEPOSIT.

NAME.....

ADDRESS.....

PR.W. 17/11/34.

Buy by Post—its Quicker—CASH—C.O.D.—EASIWAY

A FIVE-VALVE TRANSMITTER
(Continued from page 314)

marked on the circuit diagram. The H.F. coupling condenser should be of low value, .0005 mfd. being found quite suitable. Values of grid bias may be determined after experiment, using the figures in the following table as a guide.

The following are the approximate feed currents and grid-bias values for the stages.

Stage	Feed Current	Negative Bias
Oscillator (anode and auxiliary grid current)	35 mA.	15-30 volts, to be determined experimentally.
Buffer or Frequency doubler (anode and auxiliary grid current)	35 mA.	15-30 volts, as buffer. 90 volts as frequency-doubler
Modulated Amplifier	50 mA.	25-40 volts.
Modulator	63 mA.	About 90 volts.
Microphone Amplifier	5 mA.	4 to 5 volts.

For obtaining correct working values the circuit may be broken at the points marked with a cross and a suitable closed-circuit jack fitted so that a milliammeter may be inserted. The performance may be improved by inserting a 2,000 ohm resistance, shunted by a 4 mfd. condenser, between

the L.F. choke and the lead to the anode components of the T.25D valve. These should be inserted immediately next to the circuit jack in this lead.

A GOOD TEST

A BATTERY service man, of Chester, was recently involved in a motor accident, and as a result had to have six stitches in his head. This is how the accident happened. The service man in question was taking the Pye SP/B portable out for a demonstration, and on the way switched on the set to see that it was operating properly. At this point the van in which he was driving came into collision with another vehicle. The SP/B leaped into the air and hit the service man on the head, causing the aforementioned injury. Most curious of all is that the SP/B, with the van in pieces round it, continued to function perfectly. The accompanying illustration shows the SP/B portable in more peaceful surroundings.



The Pye SP/B Portable is ideal for either indoor or outdoor use.

A 3-valve Superhet for every reader —battery, A.C., Universal, or D.C. Follow "Practical Wireless" and be right!



"Good...that's found the fault... what a good thing I bought myself a PIFCO ROTAMETER"

A whole night's job becomes but a few minutes' work with the Pifco ROTAMETER. For quick tracing of troubles there is nothing like it. It tests and checks everything, even itself; any one of eight dials being brought into view by turning the octagonal knob at the side of the instrument. Convenient in size and of amazing accuracy, over 100 tests are possible with this mains or battery radio-testing instrument.



Finished in black Bakelite, complete with leads, in velvet-lined case Price **29/6**

9 SEPARATE METERS IN ONE ROTAMETER

- 1—0-3 volts. For low-tension voltage test.
- 2—0-30 volts. For grid-bias voltage test.
- 3—0-250 volts. For high-tension voltage test.
- 4—BATTERY TEST.
- 5—0-20 M.A. For individual valve test.
- 6—0-100 M.A. { For testing current taken by total valves in set.
- 7—0-250 M.A. {
- 8—FILAMENT AND RESISTANCE TEST (4,000 ohms). For D.C. and Rectified A.C.
- 9—Plug-in test for valves.

Ask your dealer to show you one now, or write for the new Pifco Testmeter Folder, describing all instruments to PIFCO LTD., SHUDEHILL, MANCHESTER, or 150, Charing Cross Rd., W.C.2

PIFCO ROTAMETERS

PIFCO ON THE SPOT WILL TRACE YOUR TROUBLES LIKE A SHOT

SEND TO "SWIFT SERVICE" FOR YOUR RADIO REQUIREMENTS

"Swift" Kits and Components are Guaranteed
B.T.S. DROITWICH BAND CONTROL COILS 3/6 each.
AMAZINGLY SELECTIVE for aerial or anode circuits.
SEND FOR FREE LIST.

THE SWIFT SERVICE & SUPPLY CO.,
3, FEATHERSTONE BLDGS., HIGH HOLBORN, W.C.1.
PHONE HOLBORN 1336. DEPT. FR.2

RECORD VALVES
MAKE NEW RECORDS!



Record valves are now cheaper than ever in price and are the cheapest you can buy. But the quality is equal to the finest valve made. A set of Record valves costs very little so replace your present worn-out valves with these splendid Records and thus enjoy perfect reception. A complete range of 2-volt and A.C. mains valves is available and it includes a valve for every purpose.

BATTERY HEATED VALVES.

- D.L.2. Special non-microphonic Detector.
- H.2. High-frequency Amplifier.
- L.2. Low-frequency Amplifier.
- L.P.2. Low consumption small power.
- P.2. Power (suitable in 2nd L.F. stage).
- S.P.2. Super Power.
- P.T.2. Pentode.
- S.2. Screen-grid H.F. Amplifier and Det.

INDIRECTLY HEATED A.C. VALVES.

- AC/HL A.C. Detector and Triode Amplifier.
- AC/S A.C. Screen-grid H.F.
- AC/V.S A.C. Variable-mu.
- AC/PT A.C. Pentode.
- AC/P A.C. Power.

RECTIFYING VALVE.

- FW.350. Full Wave Rectifier (output 300 volts, 80 milliamperes).

PRICES FROM

3/3

From your wireless dealer or from any branch of Currys. If you have any difficulty write direct to:

RECORD RADIO LTD.
Eldon St. House, 2-3, Eldon Street,
LONDON, E.C.2 Tel.: Bishopsgate 1301



THE EASY ROAD TO RADIO.
THE BEGINNER'S SUPPLEMENT

HOW THE SUPERHET WORKS—3

The Function of the First Detector, the Side-band Theory, and the Design of the Intermediate-frequency Transformers.

IT was mentioned that it is not possible to employ the ordinary type of ganged condenser in which each section is of identical capacity, but such a condenser can be used if the capacity range of the section used to tune the oscillator coil be modified. This can be done by connecting a small fixed condenser, called a padding condenser, in series with it. However, the shaped vane condenser is usually the better proposition since, for the home constructor, it is easier to gang than the padding arrangement.

Another method of mixing the oscillator frequency with the incoming frequency is that employed in the typical receiver shown in Fig. 6. It is called the cathode injector system, and has certain advantages in mains-operated receivers. It is separately illustrated in Fig. 8, and it will be seen that the oscillator coil, comprising grid and reaction windings, has another coil coupled to it. This time it is not the aerial or grid coil of the first detector, but an entirely separate winding included in the cathode lead of the detector valve (marked "injector winding" in the diagram). The condenser C1 and resistance R1, which are also included in this lead, have nothing to do with the mixing or ejector arrangement, but are simply the usual grid bias device employed in mains sets. R1, C1 correspond to R1, C6 in the full circuit in Fig. 6. You will notice that Figs. 8 and 6 are substantially the same, Fig. 8 being a simplified version of the mixer part of Fig. 6. The oscillator is shown as battery operated in Fig. 8, whereas in practice it would be driven from the mains. The tuning of the aerial and oscillator coils is, of course, the same as with the grid injector method. The only difference is that in Fig. 6 a band-pass filter is used in place of a single tuned input circuit, in order to give increased selectivity. This necessitates a three-gang condenser, the two identical sections being used to tune the band-pass coils, and the third section, with its specially-shaped vanes, being used for the oscillator coil.

The First Detector

This has two distinct currents fed into it. One is the high-frequency current due to the incoming waves, and the other is the current produced by the oscillator valve. The latter is, to all intents and purposes, a pure alternating current such as the one shown graphically in Fig. 10, but the former is a "modulated" current, that is, one which varies in strength due to the speech or music being broadcast. However, for the purposes of this explanation,

this current is also shown as a simple sine curve, as represented by Fig. 9.

Now, for the moment, let us suppose that the valve to which these two currents are fed is not a detector but an ordinary H.F. amplifier.

The output current from the valve would be represented by the oscillating current shown in Fig. 11. This graph clearly indicates the effect of the combination of the two individual currents. As already explained, their frequencies, or rate of oscillating, is slightly different; thus, at one moment they will be pulsating in step and producing a combined, extra powerful alternation, as at A, A₁ in Fig. 11, while at another time they will be out of step and will then produce only a feeble alternation, due to their individual oscillations being at that moment in opposite directions and so neutralizing one another. Such a position occurs at B, B₁ in Fig. 11. Thus the strength of the oscillations rises at A, A₁; falls at B, B₁; rises again at C, C₁, and so on at regular intervals. The rate or frequency of these risings and fallings is equal to the difference between the frequencies of the two component currents, in other words, it is an intermediate frequency.

Now, although the rising and falling

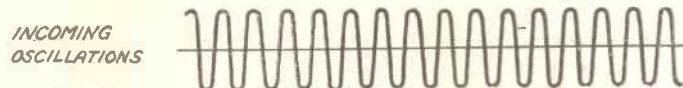

INCOMING OSCILLATIONS
Fig. 9



OSCILLATOR CURRENT
Fig. 10

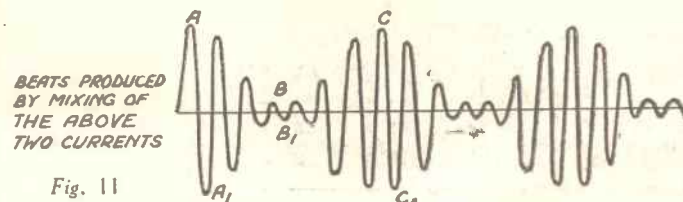

BEATS PRODUCED BY MIXING OF THE ABOVE TWO CURRENTS
Fig. 11



THE BEATS RECTIFIED
Fig. 12

Figs. 9 to 12.—Graphical representation of the working of the first detector valve of a superhet.

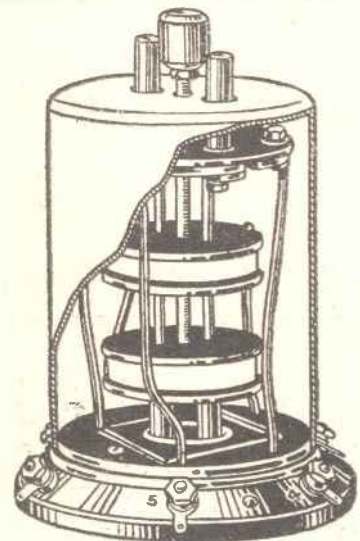

Fig. 13.—A superhet intermediate-frequency transformer in which the coupling between the coils is adjustable.

of the compound current shown in Fig. 11 occurs at the intermediate frequency, yet we cannot select and amplify this rising and falling as though it were a separate current. It is necessary to isolate it. This is carried out by using a detector valve, and not an ordinary H.F. amplifier valve. The difference is shown by comparing Fig. 11 with Fig. 12. The latter shows the nature of the output current when the valve is operated as a detector.

Anode-bend Detection

The difference between a valve worked as an amplifier and one worked as a detector is that the former gives an output which is near enough a magnified replica of the input, whereas the latter only amplifies the current pulsations in one direction; thus, when an alternating voltage is fed to the grid it amplifies the current flow in one direction, but practically cuts out the flow in the opposite direction. This effect is clearly shown in Fig. 12. For instance, the current rises from zero at X, to its full value in one direction, denoted by the rise of the curve to Y; falls again to zero at Z; and then, instead of flowing in the opposite direction, as it would do if the valve were an amplifier as in Fig. 11, it stops, so that there is a blank period during

which no current flows. After this it again rises in the same direction at P. If you compare Figs. 11 and 12 you will see that although the current in Fig. 12 only flows in one direction, yet it still retains the characteristic which we are seeking to preserve, namely, the rise and fall at the intermediate frequency. In fact, we now have a definite current fluctuating at this frequency. This is indicated by the dotted curve in Fig. 12, which shows the average effect of these uni-directional pulsations. This dotted line rises and falls at the intermediate frequency. If an amplifier valve were used it would not be possible to isolate the intermediate frequency in this way since the average line would now be identical with the zero line. In other words, although the individual pulsations of the current would rise and fall at the intermediate frequency, yet they would do so equally in both directions, and thus a large pulsation in one direction, as at A in Fig. 11, would be neutralized the next instant by a large pulsation in the opposite direction to A₁. Likewise, when the current fell as at B, B₁, its magnitude would be diminished in both directions, so that the average effect would still be nil. In Fig. 12 there are no reverse impulses to produce a cancelling out effect, and so we get a regular rise and fall in current at the intermediate frequency, as indicated by the dotted line. It is usual to use the anode-bend method of rectification with the first detector, hence, in our typical circuit there is no grid-leak as with leaky-grid detection, but instead the valve is biased by means of the bias resistance R₁.

Actually, the output current from the first detector of a superhet is infinitely more complicated than that shown in Fig. 12, and its nature was fully explained in the first article in this series. Now let us examine the input current a little more closely.

The Side-band Theory

Due to the speech, or music, which the incoming wave carries, the current induced in the aerial circuit varies in magnitude in accordance with every fluctuation in the tone and volume of the items being broadcast. As pointed out in the first article a single current which fluctuates in this manner may also be looked upon as composed of a number of pure currents of various frequencies. Thus, a 1,000 kilocycle wave carrying a single musical note of a frequency of, say, 256 cycles (middle C) will produce a current in the aerial circuit of our receiver which may be looked upon as either a single-frequency of 1,000 kilocycles which rises and falls 256 times per second, or it may be considered as being a pure alternating current of 1,000 kilocycles, another pure current of a frequency equal to the sum of 1,000 kilocycles and 256 cycles, that is, 1,000.256 kilocycles, and a third current of a frequency equal to the difference between 1,000 kilocycles and 256 cycles, that is, 999.744 kilocycles. In this case the main frequency of 1,000 kilocycles is called the "carrier" frequency, and the two attendant frequencies are known as the "side-bands."

Assuming that the input consists, as above, of only three frequencies as represented by the transmission of a single musical note, then these three

frequencies, when they are "mixed" with the oscillator frequency of 1,110 kilocycles and rectified, will produce the following frequencies in the output: 2,110, 2,110.256, 2,109.744, 110, 109.744, 110.256, these being the sum and the difference of all the input frequencies and the oscillator frequency. Besides these there are the input frequencies themselves, the oscillator frequency, and the direct-current component which constitutes the anode current of the valve. It is, however, only the intermediate frequency of 110 kilocycles and its attendant side-bands of 109.744 and 110.256 kilocycles in which we are interested at the moment. These are selected and amplified by the intermediate stage of our receiver.

The only difference between the intermediate stage (abbreviated I.F.) and an ordinary transformer-coupled H.F. stage in a straight set is that the transformers in the superhet I.F. stage do not have to be tuned with a variable condenser. They are made with just the right number of turns of wire to tune, with the aid of small pre-set condensers mounted in the base of the coils, to exactly 110 kilocycles. If you examine the circuit of the typical superhet which appeared in parts 1 and 2 of this series you will see that an intermediate frequency transformer of this type is included in the output circuit of the first detector valve, and serves to couple it to the next valve—the I.F. amplifier valve. C₄ and C₅ are the two pre-set condensers which are mounted in the bases of the coils.

The two coils comprising the transformer are coupled just closely enough to give a flat-topped resonance curve, or to put it in a somewhat less technical way, the transformer is designed to respond only to a frequency of 110 kilocycles and its accompanying sidebands—in other words, it is a band-pass filter. It is here that our two theories of electric currents come in useful, for when we think of the output current from the first detector valve which is being fed to this transformer, it is obviously easier to think of it as one current composed of the electrons which flow from the cathode to the plate of the valve, this current rising and falling all the time due to the effect of the injected oscillator current, and again, but more slowly, due to the speech or music being carried. When we come to examine the design of the I.F. transformer the second theory is much more applicable.

A Trite Axiom

The fact that very sharp tuning cuts off the side-bands and therefore leads to a loss of the higher notes of the musical scale is, of course, well known, and if we are conversant with our two theories of a modulated current it is quite easy to see why side-band cut-off affects the tone of the reproduction. Take, for example, the case of a station broadcasting on 1,000 kilocycles, and sending out a very high-pitched musical note—say, the top note of a piano which has a frequency of about 6,000 cycles (6 kilocycles). The wave radiated by the station will have a frequency of 1,000 kilocycles, and due to the musical note it is "carrying" it will rise and fall in intensity at the rate of 6,000 times per second. This wave on arrival at our receiver will, of course, induce a high-frequency current in our

aerial circuit which will have a frequency of 1,000 kilocycles, and will also rise and fall in intensity 6,000 times per second. Now, if we are conversant with this theory only, we have no explanation of the fact that the response to the high notes is reduced when we employ very sharp tuning. But if we remember our second theory we know that this high-frequency current, which is rising and falling in intensity in this manner, may also be looked upon as one unvarying H.F. current of 1,000 kilocycles accompanied by two others—one of 1,006 kilocycles and another of 994 kilocycles. Now suppose the tuning of our aerial circuit is very sharp, so sharp, in fact, that it will resonate only to the one frequency to which it is tuned. Then if we tune to 1,000 kilocycles we shall get no response to the frequencies on either side of 1,000 kilocycles. In other words, the frequencies of 1,006 and 994 kilocycles will be lost altogether, and we shall not receive the top note of the piano which is being broadcast. Actually, it is impossible to obtain such infinite sharpness of tuning as this in practice, but what happens is that with a very sharply tuned circuit the response on either side of the carrier frequency drops off so rapidly that those frequencies which correspond to the high notes are not reproduced with anything like the volume they should be.

Of course, we can always get faithful reproduction of the high notes by using flat tuning, but then it will be found that the tuning coil responds to frequencies farther than 5 or 6 kilocycles on either side of the carrier frequency; in other words, it will include other stations which are broadcasting on nearby frequencies, and we then have the well-known state of affairs where two or three stations can be heard at once.

One of the most successful devices for overcoming this disability is the type of double tuning coil known as a *band-pass filter*. This gives a flat-topped response curve, which means that it gives practically the same response to frequencies about 5 kilocycles on either side of the carrier frequency as it does to the carrier itself. Outside these limits, however, its response falls off rapidly, so that nearby stations are not received. You will notice that in our typical receiver a band-pass filter is used as the aerial and grid coils before the first detector valve.

The I.F. Transformers

Having preserved the side-bands in feeding the input current to the first detector, it would be foolish to cut them out in the next stage, for of course the intermediate frequency has accompanying side-bands in the same way as the signal frequency has. Therefore, the I.F. transformer which couples the first detector to the I.F. amplifier valve is also designed with band-pass characteristics as already mentioned. It is usually designed to respond to frequencies from about 105 to 115 kilocycles, and to reject those outside these limits. This enables a good response to musical frequencies up to about 5,000 cycles and at the same time provides a high degree of selectivity.

(To be continued.)

Even a beginner can make the
£5 3-valve Superhet.

UNDERSTANDING VALVE CHARACTERISTICS

(Continued from page 316)

matter for the non-mathematical amateur to calculate the optimum load, but in the case of nearly every three-electrode valve it is sufficient to consider it as being equal to twice the impedance or A.C. resistance. In the case of pentodes the figure is almost invariably given, since it is not necessarily proportional to the impedance. With screen-grid and variable-mu valves it can be taken as being between twice and three times the A.C. resistance.

Long- and Short-base Valves

Two terms used in conjunction with variable-mu valves which are often misunderstood, although they are really self-explanatory, are long-base and short-base. The names refer to the grid-voltage line on the anode current-grid voltage characteristic curve. The curves for the two types of valve—long and short base—are given in Fig. 3. It will be evident that the curve of the long-base valve does not touch the base line (zero anode current) until a bias voltage of 20 has been applied. In the case of the short-base valve, however, only 12.5 negative grid volts are required to reduce the anode current to zero. The long-base valve has the advantage that a rather smoother variation in volume is possible, this being particularly valuable when the receiver is used near to a powerful transmitter. The advantages of the short-base valve are that it can be used with a G.B. battery of lower voltage, whilst it is more suitable for use in a set having A.V.C., since it is more sensitive to the slight A.V.C. voltage changes applied to it.

CATALOGUES RECEIVED

To save readers trouble, we undertake to send on catalogues of any of our advertisers. Merely state, on a postcard, the names of the firms from whom you require catalogues, and address it to "Catalogue," PRACTICAL WIRELESS, Geo. Newnes, Ltd., 8-11, Southampton St., Strand, London, W.C.2. Where advertisers make a charge, or require postage, this should be enclosed with applications for catalogues. No other correspondence whatsoever should be enclosed.

INTERFERENCE SUPPRESSION

"**CRACKLING the Crackle Out of Radio**" is the title of a very interesting and useful book just issued by Belling and Lee, Ltd. The book, which runs to thirty-two pages, and is illustrated with several diagrams and half-tone illustrations, deals with the suppression of electrical interference or "man-made static." The methods used by the Post Office for the tracing and elimination of various forms of electrical interference with broadcast reception are fully dealt with, and the book also includes the results of research work on the subject by Belling and Lee, Ltd. Technical details of and methods of using various Belling-Lee suppression units are also given in the book, copies of which are available, price 6d. each, post free.

LISSEN COMPONENTS

A COMPLETE range of these popular components is given in a folder we have received from Lissen Ltd. Full particulars are given of Lissen iron-cored coils, dual range and short-wave coils, transformers, compression condensers, chokes, push-pull switches, valve holders, and pick-ups. Among the other components illustrated is the Lissen P.M. moving-coil speaker and cabinet. The speaker is fitted with a universal transformer, and can be used equally successfully with power valves, pentode valve, class "B" and Q.P.P. output circuits. Also included in the list is a complete range of Lissen valves for all circuits.

To D.C. USERS
A SPECIAL D.C. 3-Valve Superhet will shortly be described in PRACTICAL WIRELESS.

AGAIN Mr. F. J. Camm specifies



STENTORIAN EXCLUSIVELY WHY?

"As near perfection as I believe perfection is possible," says Mr. F. J. Camm.

In appearance the W.B. Stentorian is almost conventional; but make no mistake—this new instrument, incorporating three distinct revolutionary improvements on previous practice, brings an illusion of reality which is amazing.

Even if your present speaker cost double the price of a Stentorian, ask your dealer to demonstrate this remarkable new instrument. You will be astounded at the improvement.

- Unique New Magnetic Material (Prov. Pat.) gives nearly double strength and sensitivity at similar cost.
- New Whiteley Speech Coil brings amazingly crisp attack and better bass response.
- Improved "Microlode" feature provides really accurate matching to the individual set.

Stentorian Senior (PMS1)	42/-
(100 per cent. dust protection. Oversize cone)	
Stentorian Standard (PMS2)	32/6
Stentorian Baby (PMS6)	22/6



Write for the new W.B. Stentorian leaflet

Model PMS1



STENTORIAN

PERMANENT MAGNET MOVING-COIL SPEAKERS

Whiteley Electrical Radio Co., Ltd. (Dept. D), Radio Works, Mansfield, Notts. Sole Agents in Scotland: Radiovision Ltd., 233, St. Vincent Street, Glasgow, C.2. Sole Agents in I.F.S.: Kelly and Shiel, Ltd., 47, Fleet Street, Dublin.

WILLS'S CAPSTAN CIGARETTES

Flat Fifty
Cardboard Box

2/5

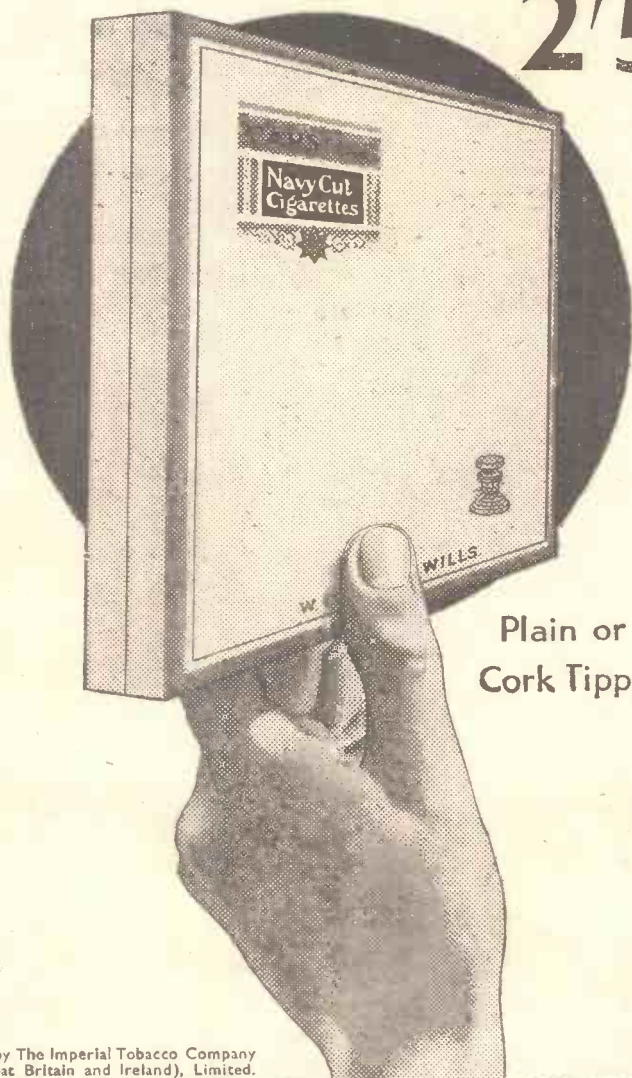

Plain or
Cork Tipped

Issued by The Imperial Tobacco Company
(of Great Britain and Ireland), Limited.

CC.460

Reviews of the Latest Records

IMPRESSIONS ON THE WAX

By T. ONEARM

THE great advantage of gramophone records over other forms of home entertainment has always been that the listener can hear what he wants when he wants it. A number of the new records released by "His Master's Voice" this month are of performances which cannot be heard in the home by any other means. For instance, the record of the month is the massed bands of the Southern Command playing "In a Monastery Garden," by Ketelbey, and a selection called "Fifty Years of Song" on *H.M.V. B8217*. This record was made with painstaking care during the Tidworth Tattoo, and reproduces with thrilling realism the grandeur of martial music played by massed bands.

The Soprano Who Never Had a Lesson

Although this will be the popular choral of the month, the record by Mileza Karjus of "Una voce poca fa" from the "Barber of Seville" with variations on Mozart's "Ah! vous dirai-je Maman," on *H.M.V. C2688*, is perhaps the finest artistically, and has the most interesting story behind it. This twenty-two-year-old girl created history a few months ago when she walked into the H.M.V. studios in Berlin completely unknown, and made that remarkable record of Strauss's "Voices of Spring" on *H.M.V. C2664*. Both the pieces which she sings on her latest record are some of the most difficult for a soprano, and she has passed with flying colours. It is all the more remarkable because Mileza declares that she has never had a singing lesson in her life, and her sole acquaintance with music and the technique of singing has been gained from playing gramophone records of celebrity artists.

A New Film Hit

Other new vocal records include Richard Crooks, the famous American tenor, giving exceptionally fine interpretations of "The Prayer Perfect," and "So We'll Go No More A'roving," on *H.M.V. D41386*, and John Brownlee singing two serenades, "Senorita," from the film "The Private Life of Don Juan," and Ravini's "Serenade," on *H.M.V. B8218*. This well-known operatic baritone displays a delightfully fine voice in these recordings. He is, of course, the artist who is responsible for the serenade in the new Douglas Fairbanks film. A new vocal artist to the English lists is Charles (Gerry) Fitzgerald, who has been deputising for Les Allen in Henry Hall's Band. The first is *H.M.V. B8216*, on which he sings two popular numbers of the moment—"I'm your slave" and "You were so charming." His voice is extremely pleasing and a relief from the usual crooner which is associated with such titles as these. There are several orchestral selections this month, including the new Mayfair Orchestra, conducted by Ray Noble, playing a potpourri of tunes from "Streamline," the new C. B. Cochran revue, on *H.M.V. C2691*. These tunes were orchestrated by Noble, and this record is

(Continued on page 341)

FACTS & FIGURES

Components tested in our Laboratories

Lissen Car Radio

MOTORING to music, which a little more than a year ago was a luxury for only the very rich in their super cars, has now become so popular that Ford Motor Co. offer Lissen Car Radio as standard optional equipment on both their Popular Ford and the new de Luxe £10 Tax Ford. The minimum prices for these two cars are £120 and £135 respectively. The new set is an all-British 5-valve dual-wave receiver, produced for Ford by Lissen, Limited. The additional cost for this set is £10, which includes the installation charge. The new Lissen Car Radio is so compact a unit that it fits in the place normally occupied by the glove pocket of the car on the dashboard. All Ford cars will, in future, be fitted with aerials as standard equipment. The makers claim good reception in any part of the British Isles.

Electradix Switchgear

WE recently received an inquiry for a cut-out, and Messrs. Leslie Dixon and Co. have sent us a copy of their latest switchgear and charger leaflets in which some interesting gear is described. These include chargers, D.C. charging boards, control boards and indicators, as well as resistances, switches, automatic cut-outs, circuit breakers, meters, indicators, etc. Readers who are in need of any apparatus of this description should write for a copy of these lists. The address of Messrs. Dixon is 218, Upper Thames Street, London, E.C.4.

Morley Permeability Tuner

THE principle of permeability tuning has already been discussed in our pages, and the only point arising in a commercial tuner of this type is how to arrange to vary the position of the iron core so that a smooth and even movement takes place which has the variation necessary to cover conveniently the present broadcast band. Even when such an arrangement has been developed for one coil, the difficulty of satisfactorily ganging two or more leads to some interesting

mechanical problems, and no doubt readers will be interested in the accompanying illustrations, which show the new permeability tuner designed and manufactured by Messrs. Morleys. As might be gathered, the unit is by no means small, the overall length being 8½ in. and the overall height being 6½ in. As may be gathered from the illustration below,

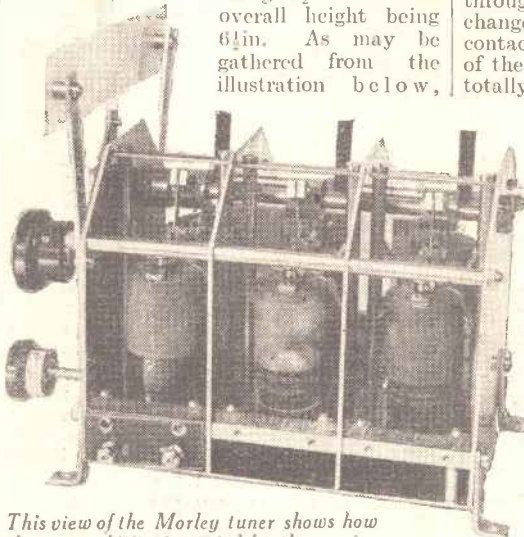

This view of the Morley tuner shows how the permeability is varied by the moving element, which passes over the coils.

the coils are arranged in a vertical position on the base of the tuner, and these coils are made up in more or less orthodox design, that is, they consist of ebonite bobbins carrying litz windings in slots. The bobbins are hollow and are mounted firmly on the paxolin base, three coils being included in each section. This division of the coils is one of the features, as the more usual method of winding one long coil with a

short-circuiting switch for long and medium waves is not very satisfactory with this type of tuner, and thus separate coils are employed, which confer the advantage that an extra wave-band can be covered without unduly increasing the size of the complete apparatus. Thus we find that in place of the more usual 200 to 550 and 900 to 2,000-metre wave-bands, in this tuner we have a 200 to 350-metre band, a 350 to 650 band,

and a 950 to 1,900 metre band which, of course, enables tuning on the normal band to be more easily carried out, as the stations are now divided up into two complete scales instead of having them contracted into one. Therefore the usual crowded band of stations between, say, 250 and 350 metres, which on the average tuning scale occupies a space of a few inches, is now spread over a scale two inches or so long and thus station separation is greatly simplified. The iron core, together with an outer casing, is raised and lowered by the movement of the control knob and thus varies the inductance of the coils in the usual manner, the movement being delightfully smooth and free from backlash. Trimmers are provided on each section, and these take the form of a small metal disc with mica separators, the ebonite rod which controls the setting of these being over an inch in length and projecting through the metal casing. The wave-change switch operates good self-cleaning contact switches in the base, and this part of the apparatus, together with all coils, is totally enclosed, thus preventing troubles due to dust, etc. On test the tuner gave splendid results, and the advantage of the three scales became very evident. The calibration of these scales (in wavelengths in metres) was substantially correct and station finding was very simple. The assembly of a receiver round these three coils is a simple matter, and the unit may be obtained with one section specially shaped for use as a superhet pack with tracking oscillator. The price is 59s. 6d. for the straight three, and 61s. 6d. for the superhet unit.

Osram Valve Guide

A COPY of the 1934-5 Osram valve guide, published by the General Electric Co., Ltd.,

has just come to hand.

The rapidly multiplying number of valve types on the market to meet modern circuit developments has set its own problem, which is to compile a reference booklet of handy size, providing complete technical information and working data for each type. This little publication certainly achieves this aim with success, measuring 5½ in. by 3 in. by less than ¼ in. thick.

The 1934 Osram valve guide gives full tabulated data of all the Osram ranges of valves, and at the same time offers a clear guide to the non-technical reader as to which valve is most suitable for every stage in a modern set.

In addition to the data charts, the Osram valve guide contains much helpful information, circuit diagrams, and useful description of the application of modern valves. A copy can be had on application to the General Electric Co., Ltd., Magnet House, Kingsway, W.C.2.

THE WIRELESS CONSTRUCTOR'S ENCYCLOPEDIA

By F. J. CAMM
(Editor of "Practical Wireless")

Third Edition. 5'-net.

Wireless Terms and Definitions stated and explained in concise, clear language.

From all Booksellers, or by post 5/6 from Geo. Neurnes Ltd., Southampton St., Strand, W.C.2.

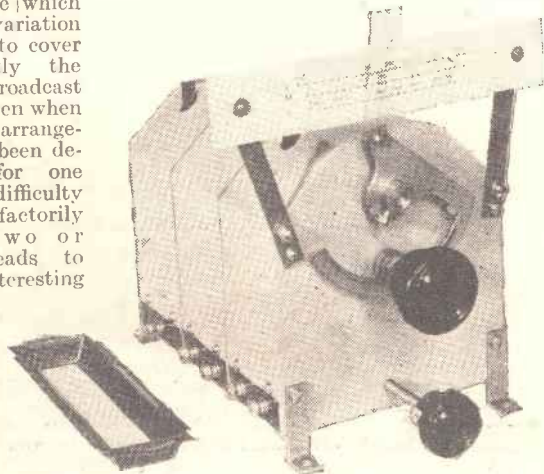

The Morley permeability tuner with escutcheon plate.

**HEYBERD
AGAIN!!**

**DESIGNED
AND
EXCLUSIVELY
SPECIFIED
FOR F. J. CAMM'S
£5 SUPERHET**

In an age of FIRST CLASS reproduction, Mr. F. J. Camm has introduced an amazing Three-Valve Superhet. Of course, for the A.C. version of this remarkable Set, he required a Reliable and efficient Power Pack. What better choice than HEYBERD? This Unit was specially constructed from the finest BRITISH materials. Follow the advice of the designer, and obtain the same outstanding results.

**PRACTICAL
POWER
PACK** **PRICE
44/-**



Post Coupon

for Heyberd handbook on Mains Working
I enclose 3d. stamps for New Handbook of Mains Equipment. Packed with Technical Tips, Service Hints and diagrams

Mr.
Address

F.C. HEYBERD & Co.,
10 FINSBURY STREET, LONDON, E.C.2
One minute from Moorgate Stn

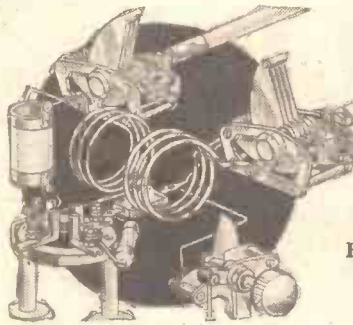

Short Wave Section

MAKING SHORT-WAVE TUNERS
Hints for Constructing Some Interesting Types of Tuning Coil for Use on the Lower Wave-ranges.

By W. J. DELANEY

ALTHOUGH we have described from time to time some interesting types of short-wave coil, there are one or two ideas which we have not dealt with before. One of the principal safeguards in short-wave work is the avoidance of losses, and thus the constructor is repeatedly told to avoid all solid material in the building of a coil. Usually this is carried out by taking very thick wire for the coil and using strips of ebonite as a support. Whilst this is quite a good scheme it is not good-looking enough for many constructors, and therefore some other arrangement is desired. A very effective method of building a coil from thinner wire, and yet still to retain the self-supporting property, is to make use of the strips of adhesive brown paper, such as are now used for sealing parcels. This material is obtainable from good stationers and is sold in the form of a roll, the width of the paper varying from 1in. upwards. A former is now required upon which to wind the coils, and if a smooth six-sided vessel of some sort can be obtained, so much the better. If not, it will be necessary to make up such a device from thin plywood. It is possible to obtain glass pickle bottles of suitable size, although it is not essential to have six sides, but this method of construction produces a more substantial coil. Tear off strips of the brown paper and lay one strip along each side of the former, adhesive side uppermost, holding them in position by sticking a further strip round the ends. The arrangement is shown in Fig. 1. Ordinary D.C.C. wire, about 20 or 22 gauge, should now be taken for the coil, and this is wound over the paper strips, the adhesive surface being moistened as winding proceeds. When the required number of turns has been wound the strip is torn from the retaining band, moistened and folded over the wire, opposite ends overlapping, and each side completed in turn. Leave to dry thoroughly and then carefully slide from

the former. The result will be a firmly-held coil of quite good efficiency. To assist in removing the coil a layer or two of paper may be wound on the former before the construction is commenced. By using a former having a mean diameter of about 3in., a set of coils may be made having 2, 3, 4, 5, 6, 7, 8, 9 and 10 turns to cover quite a wide range of wavelengths. To enable

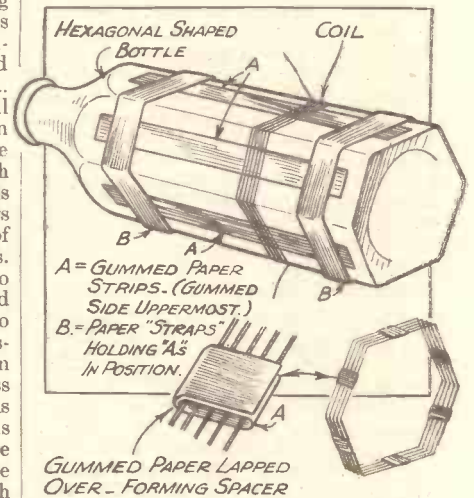

Fig. 1.—Using a bottle upon which to wind the coils. The diagram is fully explanatory.

various circuit arrangements to be tried out, a duplicate set may be constructed with tapping leads at various points.

A Complete Tuner

Many listeners dislike plug-in coils owing to the troubles which arise when changing

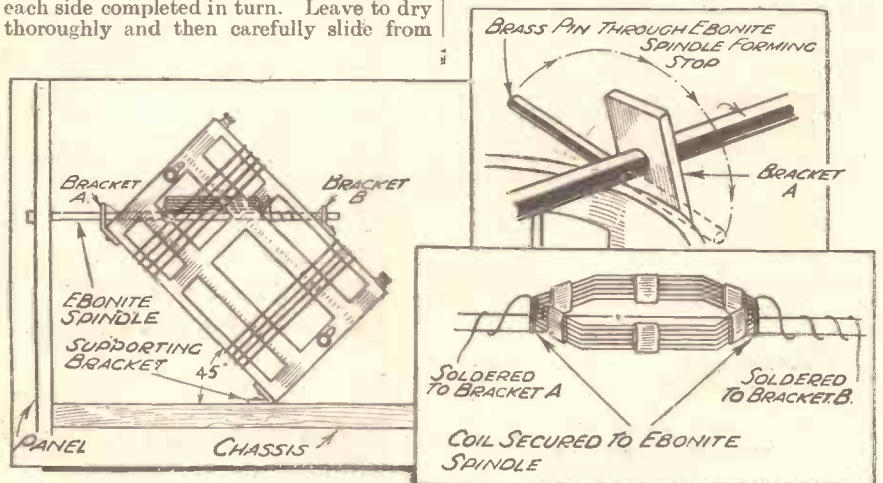

Fig. 3.—A complete tuner which offers many valuable features.

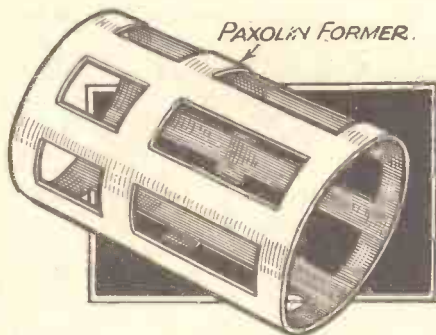
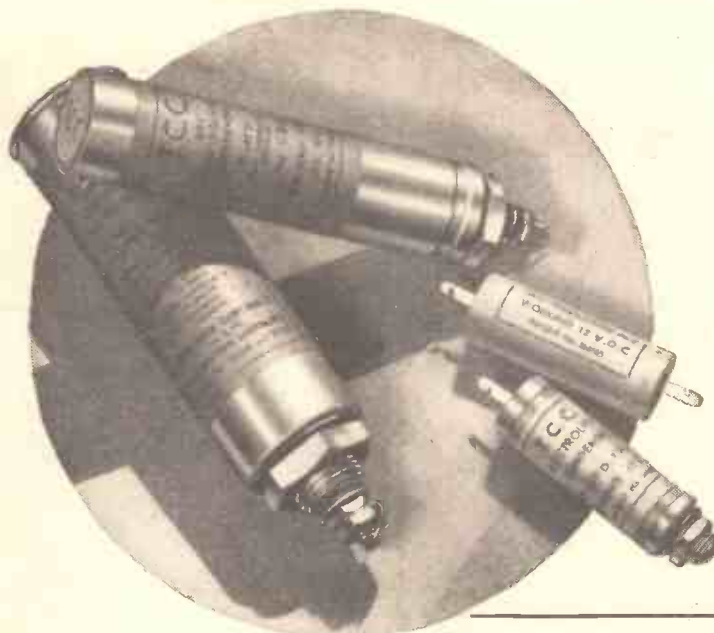

Fig. 2—How to reduce the material in a former to avoid undue losses.

coils, and the following simple tuner will enable a fair band to be covered with very good results. Naturally, it cannot be expected to have the efficiency of the separate plug-in coils, but it will no doubt prove ideal for many listeners. The former is constructed from a piece of paxolin tube, 3in. in diameter and 4½in. long. To assist in reducing the amount of dielectric and yet to give sufficient strength, pieces of the former are cut out, as shown in Fig. 2. Terminals are fastened round the end of the former, and the coil is wound with 20 D.C.C. wire. The number and type of turns will depend upon the wave-ranges which are required, as well as the circuit arrangement to be adopted, but it is not recommended that too great a range should be attempted owing to the difficulty of tuning. The tapping points, and suitable switching should be arranged according to circuit design, and the turns should be wound with a slight space between each.

A Slow-motion Effect

A single aerial-coupling coil is employed, and to provide adequate selectivity on all ranges, a full degree of coupling is provided by mounting it at an angle, and using a special form of adjustment. As may be seen from Fig. 3, the main coil is provided with a small brass bracket which is bent so that the coil is held at an angle of approximately 45 degrees. A length of ebonite rod is then mounted in a second bracket fitted at the top of the former, and a small bush is provided on the opposite side of the former so that the rod may rotate. A small aerial coil, say, 5 turns of 20 D.C.C. wire, is wound on the lines of the coils mentioned in the early part of this article, and when dry this is attached to the ebonite rod. It will thus be seen that rotation of the ebonite rod will turn the coil through 90 degrees for a movement of 180 degrees of the control knob, and thus it is possible to obtain a very smooth degree of coupling. Small loops in the end of the lead will enable the coil to rotate without relying upon a rubbing contact, and a stop in the form of a short piece of stiff wire in the ebonite rod will prevent the coil from being rotated through more than 180 degrees and thus breaking the lead. It must be emphasized, of course, that the efficiency of this type of tuner will not be so high as when using separate coils, but to many this will be offset by the advantage gained in being able to cover a fairly wide range without coil changing, and in having panel control of selectivity.



NEW TYPES
of
ELECTROLYTICS
for the
CONSTRUCTOR

Originally designed to meet the exacting demands of leading commercial set manufacturers, these electrolytics are now available for use in your own receiver.

Special attention is drawn to the Tubular Types "A.T." and "C." with their "manufacturer's" facilities for ease of wiring and mounting. Use T.C.C. Condensers and give your set that "professional look"—and DEPENDABILITY.

ASK YOUR DEALER FOR NEW T.C.C. CATALOGUE OR WRITE US DIRECT

DRY ELECTROLYTICS—TUBULAR

CAPACITY MFDS.	WORKING VOLTAGE	PRICE	
		TYPE "AT"	TYPE "C"
2	200 D.C.	s. 2	d. 6
10	50 D.C.	2	3
20	50 D.C.	2	3
25	25 D.C.	2	9
50	12 D.C.	2	3

Type "AT" with soldering tags. Type "C" one hole chassis fixing.

AQUEOUS ELECTROLYTICS

TYPE NO.	CAPACITY MFDS.	MAX. WORKING VOLTS.	PRICE
805	18	500 D.C.	s. 7
802	16	440 D.C.	d. 0

In aluminium cans—one hole fixing.

DRY ELECTROLYTICS

TYPE NO.	CAPACITY MFDS.	MAX. WORKING VOLTS.	PEAK VOLTS	PRICE
502	4	450	500	s. 4
502	8	450	500	d. 0
902	4	500	550	5 0

In aluminium cans—one hole fixing.

T.C.C.
ALL-BRITISH
CONDENSERS

THE TELEGRAPH CONDENSER CO. LTD., WALES FARM ROAD, N. ACTON

Newnes' TELEVISION AND SHORT-WAVE HANDBOOK

Turn to page 309 and Claim Yours Now!

ANNOUNCEMENT

★ to men who want careers in RADIO



The I.C.S. Radio Courses cover every phase of radio work, from the requirements of the youth who wishes to make wireless engineering his career to the man who wants to construct and maintain a broadcasting set for his home.

The Radio industry is progressing with amazing rapidity. Only by knowing thoroughly the basic principles can pace be kept with it. Our instruction includes American broadcasting as well as British wireless practice. It is a modern education, covering every department of the industry.

OUR COURSES

Included in the I.C.S. range are Courses dealing with the installing of radio sets and, in particular, with their Servicing, which to-day intimately concerns every wireless dealer and his employees. The Operating Course is vital to mastery of operating and transmitting.

There is also a Course for the Wireless Salesman. This, in addition to inculcating the art of salesmanship, provides that knowledge which enables the salesman to hold his own with the most technical of his customers.

Then there are the Preparatory Courses for the City and Guilds and I.W.T. Exams.

We will be pleased to send you details of any or all of these subjects. Just fill in, and post the coupon, or write in any other way.

International Correspondence Schools, Ltd.,
Dept. 94, International Buildings,
Kingsway, London, W.C.2.

Without cost, or obligation, please send me full information about the Courses I have marked X

- COMPLETE RADIO
- RADIO SERVICING
- RADIO EQUIPMENT
- RADIO SERVICING AND SALESMANSHIP
- WIRELESS ENGINEERING
- WIRELESS OPERATORS
- EXAMINATION (state which)

Name Age

Address

PRACTICAL LETTERS FROM READERS

The Editor does not necessarily agree with opinions expressed by his correspondents. All letters must be accompanied by the name and address of the sender (not necessarily for publication).

D.C. Version of £5 Superhet

SIR,—Being a reader of PRACTICAL WIRELESS since the publication of No. 1, I have looked forward to the day you would publish a circuit such as the £5 superhet, but for D.C. mains. So I sincerely hope you will soon consider D.C. users. I really believe you have a good circuit in your £5 super, and I may state that in this letter I am voicing the opinion of a great number of D.C. mains users.—OWEN DAVIES (Neath).

[An announcement concerning a D.C. version of the £5 superhet has already been made.—ED.]

Spending Results with the "Empire Three."

SIR,—I have been a reader of PRACTICAL WIRELESS for over a year and a half, and can honestly say that it's taught me all I know about wireless. To come to the point, I made your Empire Three a year ago, and since then I have had 187 different stations, including telephony, amateur and broadcast. I am a member of the International S.-Wave Club, and am trying to get the All-Continents Certificate. I have received them all with the exception of Africa, so I require a little more sensitivity. I thought of adding an H.F. stage with an H.F. pentode.

Bound Brook W3XAL 16.87 m., and W8XK 19.72 come in every afternoon like locals, W3XAL at R7 and W8XK at R6.—W. D. S. MATTHEWS (Llanely).

A Short-waver Wanted

SIR,—As a reader of PRACTICAL WIRELESS I must congratulate you on the production of such an excellent journal. I have only taken up wireless since May this year, and have found the articles, etc., of great assistance to me.

I notice in your issue of September 8th, 1934, you are including in your winter programme a really efficient S.-W. Receiver plus the medium bands, vide request from R. Green, Kenya.

What we want in India is a real S.-W. set less medium bands, and should greatly appreciate a circuit for a set.

Could not Daventry give India an extra 10 kW., and enable us to get in touch with home?—L. BUCKLEY (Waziristan, India.)

[Do any other readers require a receiver of this type? As we have stated on many occasions, we are always willing to assist readers, but cannot design a receiver for one individual.—ED.]

A Quality Set

SIR,—In the correspondence columns of PRACTICAL WIRELESS I often see readers' letters stating what they and their friends would like in the way of receivers, and very often one finds that they are more or less for designs that have already appeared.

May I therefore take up some of your space and say what my friends and I would like. As far as I know, this type of receiver has not been published in PRACTICAL WIRELESS. It is a set with 2HF, A.V.C.

and push-pull or duophase output, band pass tuning, tuning indicator, and an output of about 4 to 6 watts. Naturally such a set would be A.C.

Perhaps there are many other readers who would like a real quality receiver and not one with a nice tone.—THOS. J. EVANS (Monmouth).

Extraordinary Success of £5 Superhet Three

SIR,—In your position as designer you probably find it difficult sometimes to publish sets which will satisfy the majority of readers. Your latest set, the £5 super, however, has met with extraordinary success, probably due to it being a complete breakaway from the usual trend of design. This superhet will satisfy a large number of readers who want a really good, cheap, selective set, but for those readers, like myself, who are far from any station, or who live on flats, a set of this type would not be ideal, employing as it does only three valves. I therefore suggest that a four-valve version of this unique set should be published.

Due to the building of the new Northern station, a large number of constructors in the north are proposing building superhets, as that type of set alone can provide sufficient selectivity. Therefore I assure you that the four-valve version of your set would be extremely popular.—R. MILNE (Inverness).

[The Three-valve Superhet employs five stages and gives 1 watt output—ample for most purposes.—ED.]

CUT THIS OUT EACH WEEK

Do you know

—THAT a ready method of ascertaining the value of grid-bias required for a valve is to divide the applied H.T. voltage by double the amplification factor.

—THAT additional reaction control may be obtained by connecting a variable resistance across the reaction winding.

—THAT a resistance may also be joined in the anode circuit, to function as a smooth reaction control, by varying the applied H.T.

—THAT some care is needed in the choice of condensers for a voltage-doubler circuit in a mains circuit.

—THAT iron-cored coils may be included in an aerial circuit for use in wave-trap fashion.

—THAT the above scheme forms an admirable method of avoiding second channel whistles in a superheterodyne receiver.

—THAT corrosive fluxes should not be employed when soldering wireless apparatus.

The Editor will be pleased to consider articles of a practical nature suitable for publication in PRACTICAL WIRELESS. Such articles should be written on one side of the paper only, and should contain the name and address of the sender. Whilst the Editor does not hold himself responsible for manuscripts, every effort will be made to return them if a stamped and addressed envelope is enclosed. All correspondence intended for the Editor should be addressed: The Editor, PRACTICAL WIRELESS, Geo. Newnes, Ltd., 8-11, Southampton Street, Strand, W.C.2.

Owing to the rapid progress in the design of wireless apparatus and to our efforts to keep our readers in touch with the latest developments, we give no warranty that apparatus described in our columns is not the subject of letters patent.

RADIO CLUBS AND SOCIETIES

Club Reports should not exceed 200 words in length and should be received First Post each Monday morning for publication in the following week's issue.

ANGLO-AMERICAN RADIO AND TELEVISION SOCIETY

MR. LESLIE W. ORTON outlined the tests which were being carried out by the Society's official station (G-2YH) during a talk given over that station on November 4th. He invited short-wave listeners to send in reports of the Sunday transmissions, and to include in their reports such details as strength, fading, weather and temperature.

G-2YH transmits every Sunday from 11.0 to 11.30 a.m. G.M.T. Reports of reception should be addressed to Mr. Ernest Hobden, 10, Denecroft Gardens, Grays, Essex.

SHORT-WAVE RADIO AND TELEVISION SOCIETY

THIS society, of Thornton Heath, held its usual weekly meeting at St. Paul's Hall, Norfolk Road, under the chairmanship of Mr. S. J. Meares (2BPL), on Tuesday evening. Mr. Munnion, of the Ultra Electric Company, gave a talk on set construction, with particular reference to the "Ultra 22," which was later demonstrated to the members. The output on the local station was 23 watts. The output valve in this set is a double-diode-pentode, the diode portion being used as second detector. Throughout the whole of the set the aim of the Ultra Electric Company had been to improve the quality of reproduction as compared with their previous models. A great deal of care was taken with the tuning coils. These were wound with litz wire, bank wound on formers mounted on a steatite base. Mr. Munnion then went on to describe how their components and lastly the completed receiver were thoroughly tested before leaving the factory. Particulars of future meetings and discussions may be obtained from Hon. Sec., Mr. Jas. T. Webber, 368, Brigstock Road, Thornton Heath.

RADIO, PHYSICAL AND TELEVISION SOCIETY

"THE Spectrum of Radiant Energy" was the title of a lecture demonstration given on Friday, November 2nd by Dr. C. G. Lemon, F.Ph.Soc., A.M.I.R.E. The lecturer commenced by illustrating on the black-board the whole spectrum of energy, from 50 cycle A.C. to cosmic rays. Each type of radiation was explained, and in most cases produced, with demonstrations of its effects. The lecturer showed, also, how it was possible to detect different types of radiations. Considerable interest was shown in the demonstration of X-rays, and members were surprised to learn that a voltage of 150,000 was used on the X-ray tube. Meetings are held at 72a, North End Road, West Kensington, W.14, and all readers of PRACTICAL WIRELESS residing in the district are cordially invited. Further particulars of lectures, etc., can be obtained from the Assistant Hon. Sec., M. E. Arnold, 12, Nassau Road, Barnes, S.W.13.

INTERNATIONAL SHORT-WAVE CLUB (LONDON)

THE meeting of the London Chapter, held on Friday, November 2nd, commenced with a review of the week's listening, given by Mr. A. W. Preedy and Mr. A. F. Larkman. This was followed by a talk on "Short-Wave Listening in the Early Days," by Mr. George F. Brooks. Mr. Brooks spoke of his own experiences in New York and Puerto Rico. This was when there were very few short-wave stations to be heard, among them KDKA (60 metres), PCJJ, etc. His experiences in the tropics were most interesting. All PRACTICAL WIRELESS readers in the locality are invited to attend our meetings.—A. E. BEAR, Secretary, 10, St. Mary's Place, Rotherhithe, London, S.E.16.

THE CROYDON RADIO SOCIETY

HIGH-QUALITY reproduction, and heated argument upon it, provided an interesting programme for the Croydon Radio Society's meeting at St. Peter's Hall, S. Croydon, on Tuesday, October 30th. A member, Mr. L. W. Luce, brought his Duophase amplifier, H.12 High Fidelity Piezo Electric pick-up and Hartley-Turner loud-speaker, and with the excellent acoustic properties of the hall, some more than ordinarily good reproduction was obtained. There was a lively discussion on all important topics like records, their grooves, how the needle travelled in them, the precise effect of dust, and the best method of its removal. Needles, of course, came in for much discussion also; thick, thin, wooden or steel all having ardent supporters. Altogether, by the time the meeting closed, members felt they had learnt a great deal on the essentials for high-quality reproduction. The Society's session is now well under way, and PRACTICAL WIRELESS readers are invited to write for particulars of membership, as well as the fixture card.—Hon. Secretary: E. L. CUMBERS, Maycourt, Campden Road, S. Croydon.

50 Tested Wireless Circuits

By F. J. CAMM
(Editor of "Practical Wireless.")
Obtainable at all Bookstalls or by post
2/9 from Geo. Newnes, Ltd., 8-11,
Southampton St., Strand, London, W.C.2

2/6

SPECIFIED £5 3-VALVE SUPER-HET B.T.S.

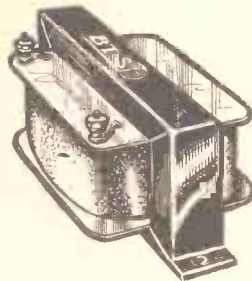

L. F. CHOKO
Chosen by Mr. F. J. Camm for the A.C. Version of the £5 3-Valve Super-Het. Specially designed to "Practical Wireless" Specification. Inductance 40 henrys at 60 m/a

L. F. TRANSFORMER
3.5—1 Ratio. As specified for the A.C. version of the £5 3-Valve Super-Het by Mr. F. J. Camm. Manufactured to the specification of "Practical Wireless."

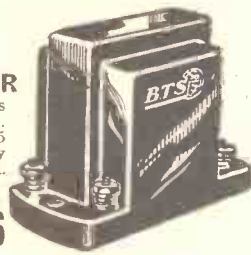

B.T.S. Components are obtainable from all Radio Dealers

B.T.S. DROITWICH BAND CONTROL COILS

In cases of difficulty, send direct to B.T.S., postage refunded. B.T.S. are Specialists in Short Wave and Television technique... send for our latest lists of Television Kits and Components; Short Wave Battery and Mains Receiver Kits.

Receive RADIO-PARIS without interference from DROITWICH with these amazing new Coils. No others give that high selectivity characteristic of modern commercial Sets... the result of the NEW WAVE WINDING, for the first time made available to the Home Constructor by B.T.S. interchangeable for Aerial or Anode Circuits.

SEE THE NEW WINDING—IT GIVES BAND CONTROL.

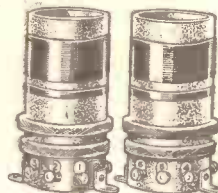

BRITISH TELEVISION SUPPLIES, LTD., BUSH HOUSE, LONDON, W.C.2
Telephone: TEMPLE BAR 0134. Telegrams: TELEVIEW, BUSH, LONDON

DISPOSAL OF LIQUIDATION STOCK

LIMITED QUANTITY ONLY—BRAND NEW VALVES

BY WELL KNOWN LEADING BRITISH MANUFACTURER

DETECTOR, H.F. OR POWER

Usual Prices 7/6 to 16/6 **2'9** EACH POST FREE

Screened Grid & Pentode 3/9

Take advantage of this astounding offer to give your Set a new lease of life for winter evenings. New valves mean new life, Power, and Sensitivity. Suitable for all sets using batteries or eliminators. We Guarantee your satisfaction with every valve. If in doubt as to type to order, state make and type now in use, and we will send the equivalent. Don't hesitate. This offer cannot be repeated when present stock is exhausted. Send P.O. NOW to:

RADIO & ELECTRICAL WHOLESALE SUPPLY, LTD. (Dept. P), 6, Conduit Street, London, W.1.

EASY TERMS

IF YOU WANT PROMPT DELIVERY ENTRUST US WITH YOUR ORDER

Buy your Radio Apparatus on convenient terms from the Service House which guarantees the efficiency of everything supplied. Illustrated leaflets giving full particulars free on request.

C.O.D. SERVICE.

Any Kit of parts or single component supplied for Cash or C.O.D. by return of post, POST FREE.

2/6 W. B. Stentorian Senior P.M. Speaker. Secures delivery Cash Price £22/0, or 2/6 with order and 11 monthly payments of 4/-.

2/6 W.B. Stentorian Standard P.M. Speaker. Secures delivery Cash Price £11/2/6, or 2/6 with order and 11 monthly payments of 3/-.

4/6 Rola FR7 P.M. Moving-Coil Speaker, with Universal Transformer. Secures delivery Cash Price £22/9/6, or 4/6 with order and 10 monthly payments of 5/-.

5/- Atlas T10/30 H.T. Eliminator and Trickle Charger combined. Secures delivery Cash Price £3/9/6, or 5/- with order and 12 monthly payments of 5/11.

5/- Pifcometer de Luxe, every possible fault in a receiver can be quickly traced with this instrument. Secures delivery Cash price, 42/-, or 5/2 with order and 8 monthly payments of 5/-.

5/- VALVES. Every type of valve replacement supplied on convenient terms. Secures delivery 3 Valves—Mullard, Cosmor, Marconi, S.G., Det., Power. Cash Price £1/5/0, or 5/- with order and 5 monthly payments of 4/7

Estd. 1925 THE NATIONAL 1977

LONDON RADIO SUPPLY COMPANY

11, OAT LANE-NOBLE STREET-LONDON, E.C.2



By JACE

British Wireless at Paris Aero Show
MARCONI transmitting and receiving apparatus, specially designed for use in fighter aircraft, will be carried as part

of the modern equipment of the Armstrong Whitworth "Scimitar" fighter to be exhibited at the Paris Aero Show. The Marconi Company has made a special study of the problems connected with wireless communication for fighter aircraft in order to give this class of machine the advantages of wireless communication with other aircraft, and with the ground, without impeding speed or manoeuvrability.

In the Armstrong-Whitworth "Scimitar," the difficulties of designing suitable transmitting, receiving, and aerial equipment for small high speed aircraft have been overcome. By the use of special valves in the transmitter, one working as a combined master oscillator and magnifier,

and the second as a combined modulator and sub-modulator, a high standard of working efficiency has been attained, while the size and weight of the apparatus has been reduced. Communication can be carried out on telephony or telegraphy (continuous and interrupted continuous waves), and a small point of practical importance is that the tuning control of the master oscillator circuit is calibrated directly in metres in order to facilitate rapid tuning. The receiver is of the superheterodyne type and employs six I.-H. valves.

Both transmitter and receiver are designed to cover a wave-range of 50-100 metres (6,000-3,000 kilocycles). By the addition of an extra panel to the transmitter provision can be made for quick wave-changing between any two pre-selected wavelengths between 50 and 130 metres (6,000 and 2,308 kilocycles). The receiver can also be arranged for quick wave-changing if desired.

Special attention has been given to the aerial system in order to reduce wind resistance, and a special fixed aerial is employed, with streamlined insulators. Power supplies can be drawn either from a wind-driven generator or a rotary transformer.

SEVEN-POINT ANCHORAGE



It is well known that the valve which is most likely to emit microphonic noises is the detector. This failing can invariably be traced to an incorrect method of filament mounting.

In the HIVAC Type D.210 (special Detector) the filament is anchored at seven points, and supported from above by a hairpin spring.

This complete immunity from extraneous noises is yet another HIVAC "Hidden Value."

You can greatly improve the efficiency of your receiver and add to the quality of reproduction by using the Hivac Non-microphonic Detector Valve D.210. It only costs three shillings and ninepence. Buy one now. Most dealers sell them and all Curry's branches can supply you with any valve in the Hivac range.



HIDDEN VALUE

BATTERY TYPES FROM 3/9

MAINS TYPES FROM 9/6

Hivac 1935 Valve Guide and Comparative Table "N" Free on request.

SILENT BACKGROUND

BRITISH MADE by High Vacuum Valve Co. Ltd., 113-117 Farringdon Road, London, E.C.1

Broadcasting in Wales

ACCORDING to a B.B.C. announcement, a conference was held at Broadcasting House, London, between the Broadcasting Committee of the Council of the University of Wales and representatives of the Corporation, under the chairmanship of Mr. R. C. Norman. The Committee recorded its satisfaction with the recent increase in the hours of Welsh broadcasting and expressed hope that more Welsh schools would, in the future, take advantage of the broadcast lessons in the Welsh language provided by the B.B.C.

The Committee and the Corporation expressed regret that the promised studio in Bangor would probably not be opened before the end of 1935, owing to the absence of suitable line facilities. The Corporation announced that every effort would be made to speed up the work.

In connection with the Committee's request for an additional relay station in North Wales, the B.B.C. pointed out that its first object had to be the provision of a National programme, covering the whole of Great Britain and Northern Ireland. This had been largely effected since the opening of the new National transmitter at Droitwich. The B.B.C.'s second objective was to provide all its listeners with alternative programmes of a Regional character. Constructional work was in hand which would achieve this object to a very large extent, but a number of gaps would remain, among which North and Central Wales was one. As soon as the present constructional work was finished, which was expected to occupy a period of at least eighteen months, the Corporation would be in a position to consider steps for dealing with these gaps.

The Committee claimed that a relay station in North Wales should not be considered on technical and population grounds only, and that the unique cultural and linguistic characteristics of Wales justified the immediate establishment of such a station. The Corporation recognized this point of view and said that sympathetic consideration would be given to it in the determination of future policy.

EASY PAYMENTS

"There's no place like HOLMES"

W.B. SPEAKERS.

	Deposit	Monthly Payment
STENTORIAN SENIOR ..	42/-	4/7
STENTORIAN STANDARD ..	32/8	4/5
STENTORIAN BABY ..	22/6	4/-

KIT SETS

	We strongly recommend.	
TELSEN 323 KIT ..	29/6	7 of 4/1
TELSEN S.G.3 KIT ..	39/6	9 of 4/4
LISSEN SKYSCRAPER 3 ..	77/6	11 of 7/-
LISSEN SKYSCRAPER 4 ..	115/6	11 of 10/3

COMPLETE SETS

	Unbeatable value.	
COSSOR MELODY MAKER 352	119/-	10/10
COSSOR ALL ELECTRIC 357 ..	150/-	14/7
G.E.C. BATTERY COMPACT 3	117/6	10/9
FERRANTI LANCASTRIA ..	£12.12	23/-

ACCESSORIES

	of merit	and	fine value
EXIDE H.T. ACC. 120v. ..	60/-	6/-	9 of 6/8
ATLAS ELIMINATOR T 10/30	69/6	6/-	11 of 6/4
AVOMINOR METER ..	40/-	5/6	7 of 5/6
B.T.H. LATEST PICK-UP ..	40/-	4/5	9 of 4/5

Parts for any set. Any make of speaker. New goods obtained for every order.

Send us a list of the parts you require, or the set you have selected, and we will send you a definite quotation. Ten years' advertisers in Wireless Press. Thousands of satisfied customers.

H. W. HOLMES,

29, Foley Street, Great Portland Street, London, W.1. Phone: Museum 1414.

"OSOEEESI"

NEW WONDER SAFETY AERIAL

NO RISK
NO EARTH
ABOLISHES ALL
MENT TO WALLS.
GIVES A L
AS CLEAR AS
GREATER SELEC
HAVE EVER
BEFORE WITH
FREEDOM FROM
FOREIGN NOISES.
MAKES LISTENING
LESS PROGRAMME
STOPS UNWANTED
FEERING AND
ONLY ONE WIRE
"OH, SO EASY." A
NO BROKEN LIMBS
REPLACING AERIAL

OF LIGHTNING
REQUIRED
POLES, AND FIT-
etc.
FOREIGN STATIONS
A BELL WITH FAR
TIVITY THAN YOU
EXPERIENCED
UNBELIEVABLE
STATICS AND OTHER

IN TO YOUR WIRE-
A PLEASURE AND
STATIONS INTER-
"BUTTING" IN
TO YOUR SET
CHILD CAN FIX IT
AFTER STORMS

Price 7/6
with instruction or 3/6 with order and 5 weekly payments of 1/-
Magnetic earth wires. From ALL WIRELESS STORES or
SOUTHERN SUPPLY CO. LTD.,
81, Nantun Drive, Thornton Heath, Surrey.
WATKINSONS LTD.

SMASHING PROOF

Recharges itself overnight



Any voltage supplied.

WET H.T. SUPREME

If you want to really solve the H.T. problem for good you cannot do better than follow the lead of the thousands who use a Standard Wet Battery. "12 months' service on a 3-v. set going ten hours a day, when an ordinary dry battery lasted only 7 weeks," writes R.S. 120-v. 12,500 m.a. £2 complete, carr. paid. Lasts years. Replenish at long intervals—that's all. All Standard H.T. spares supplied. Write for details of this money-saving H.T. Note new address: WET H.T. BATTERY CO. (P.R.W.), 95, Dean St., Oxford St., W.1. Gerard 6121.

Build it with your own hands

"SKYSCRAPER" BAND-PASS 3

WRITE FOR FREE CHART
LISSEN LIMITED, ISLEWORTH, MDDX.



LISSEN

M.P.R. ALL-ELECTRIC 3 VALVE A.C. RECEIVER

A wonder set for those wishing to hear the main stations with clarity and pure undistorted reproduction, without cabinet. Latest "clock-face" tuning. Output 2 watts. Ask your dealer for demonstration or send for fully illustrated details.

£5-17-6
OR 2/6 WEEKLY

M.P.R. LTD. R.F. LTD. ESSEX

PATENTS AND TRADE MARKS.
KING'S PATENT AGENCY, LTD., 146B, Qn. Victoria Street, E.C.4, offer "Advice Handbook" and Consultation free. 49 years' references. Write, call, or phone. Phone: City 6161. Director, B. T. King, C.I.M.E., Reg. Patent Agent, G.B., U.S.A. and Canada.

IMPRESSIONS ON THE WAX

(Continued from page 334)

one of the last he made before leaving for America. Florence Desmond, the star of this new show, has already recorded her song for "His Master's Voice," and they will be released shortly.

Dance Tunes

There are several new good dance records, the most haunting probably being the "Isle of Capri," by Ray Noble's Orchestra on H.M.V. B6519, coupled with a waltz—"Grinzing," which is a tune really taken from an old Austrian air. Noble's orchestra has also produced brilliant recordings of "Love, wonderful Love" and "Sing as we go" from Gracie Fields' film, on B6514, and two haunting waltzes, "The Prize Waltz" and "Moonlight is silver," on H.M.V. B6516. Jack Jackson and his Orchestra show high spirits in their record of "Wedding on the Air" on H.M.V. B6521, coupled with a new foxtrot, "Ache in my heart." This band is also responsible for one of the first records of two hits from "Streamline": "Kiss me dear" and "You turned your head," on H.M.V. B6522. Other tunes being broadcast at the moment, and which will be wanted by many dance fans, are "With my Eyes wide Open I'm Dreaming" and "Moon Glow," by well-known American dance bands on H.M.V. B6517, and "For all we know" and "Say it" on H.M.V. B6518.

Sterno Records

Charlie Kunz, the popular conductor of the Casani Club Orchestra, introduces yet another medley record this month on Sterno 1487. This record is the ninth in the "Kunz Medley" series, and introduces such tunes as "When a woman loves a man"; "True"; "Isle of Capri"; "Lady of Spain"; "Dreamy Devon"; and "Life's Desire." If you like pianoforte solos you should certainly hear this record. Popular dance tunes by the Casani Club Orchestra, directed by Charlie Kunz, are "Love in Bloom," from the film "She loves me not," and "With my Eyes Wide Open I'm Dreaming," from the film "Shoot the Works," on Sterno 1488, and "Cocktails for two" and the "Wedding on the air," on Sterno 1489. All very good fare for the dance fan and well recorded.

Decca-Polydor Records

In response to very enormous insistent requests, the Polydor version of the "Nutcracker Suite," has been made available for the public of Great Britain. This delicious and graceful Suite by Tchaikovsky is played with remarkable artistry by the Berlin State Opera Orchestra, conducted by the erudite Oskar Fried. The title of the work and the titles of the sections are printed in English, in order that the music may be more clearly understood. (CA8182-CA8183-CA8184.)

And there is what I think you will regard as the finest Schlusnus record, "No Sleep, No Rest, for my Afflicted Soul" ("Prince Igor") and "Song of the Flea" ("Faust"). His singing of the great song from "Prince Igor" is exceptionally beautiful. (CA8185.) The record of Sarasate's "Gipsy Airs," played by Simonne Filon, is an example of violin gymnastics, exhibitions of which used to fascinate our fathers and grandfathers. The gentle art of virtuosity is not fashionable nowadays, but, when all is said and done, sheer violinistic display is a great feat, and I am sure that this record will interest you as a spectacular exhibition.



Thousands of the Technical Experts who are now in well-paid regular employment, started radio as a hobby. Their hobby has brought them success.

You, too, can study at home and qualify for interesting and well-paid radio work. Inventing, Designing, Research and Laboratory work, Technical writing, Installation, Maintenance, Testing, Servicing, Set building, and many other specialised occupations are open to the man who knows radio thoroughly. Radio offers rich rewards to the trained man.

We can train you and introduce you to employers, or teach you how to earn money in your spare time. We have helped others; we can help you.

Our Correspondence Courses are praised and recommended by leading Radio Manufacturers and the Technical Press. We specialise in radio and all our Courses are conducted by Radio Experts with practical knowledge of the qualifications that lead to success, employment and a good income.

Why jog along in the same old rut? Why fear the consequences of losing your job? Why waste your valuable spare time?

Wherever you live and whatever you do, radio offers you success, security, a spare-time income, or well-paid employment.

Send at once for free copy of our latest Prospectus and learn how we can put you on the road to success.

(Post Coupon Below)

Technical & Commercial RADIO COLLEGE

CROMWELL HOUSE
HIGH HOLBORN LONDON W.C.1
Telephone Chancery 7054 & 7055

(Post in unsealed envelope, 3d. stamp.)

To: T. & C. RADIO COLLEGE,
Cromwell House, High Holborn, London, W.C.1.

Please send me free copy of your latest Prospectus.

NAME

ADDRESS

Pr.23

REPLIES TO

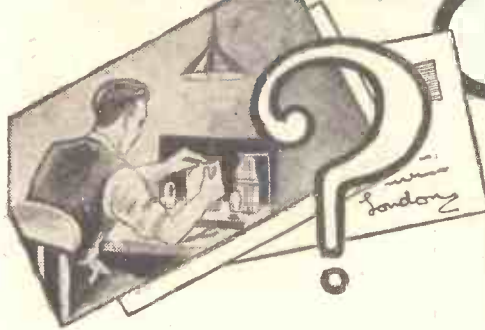
LET OUR TECHNICAL STAFF SOLVE
YOUR PROBLEMS

QUERIES and ENQUIRIES

by Our Technical Staff

The coupon on Cover iii must be attached to every query.

If a postal reply is desired, a stamped addressed envelope must be enclosed. Every query and drawing which is sent must bear the name and address of the sender. Send your queries to the Editor, PRACTICAL WIRELESS, Geo. Newnes, Ltd., 8-11, Southampton St., Strand, London, W.C.2.

SPECIAL NOTE

We wish to draw the reader's attention to the fact that the Queries Service is intended only for the solution of problems or difficulties arising from the construction of receivers described in our pages, or on general wireless matters. We regret that we cannot, for obvious reasons—

- (1) Supply circuit diagrams of complete multi-valve receivers.
 - (2) Suggest alterations or modifications of receivers described in our contemporaries.
 - (3) Suggest alterations or modifications to commercial receivers.
 - (4) Answer queries over the telephone.
- Please note also that all sketches and drawings which are sent to us should bear the name and address of the sender.

Only One Waveband

"I have built the A.C. Leader as described in 'Practical Wireless,' but find that only one waveband is received. The set is also unstable and selectivity is bad. Could you advise me what remedy to apply?"—W. W. (Kenton).

The difficulty is probably due to the wave-change switch. Firstly, the switch must be earthed, in order that both long-wave windings will be shorted out on medium waves. If the switch is of the wrong type and does not make good contact with the chassis it will not do this. Care must also be taken that the coils are correctly wired, and you should check your wiring with the wiring plan published in the issue concerned.

Use a Counterpoise

"I would like to know the simplest method of earthing for my radio. I have a good aerial in a loft, this being my only practical position, but am puzzled as to the earth. I live on the top floor of a house in which there are no heat radiators nor cold water systems in the top floor. To run a wire to the water pipe would mean some thirty feet of wire. The set is a four-valver."—J. D. M. (Blaydon-on-Tyne).

A counterpoise would probably solve your problem. Arrange a length of wire equivalent to your present aerial, and fix this beneath the aerial, and parallel to it. If the aerial is at the top of the loft no doubt the counterpoise could run along the floor. Some experiment may be necessary to find the best amount of wire for both

aerial and earth. Take the same care with insulation in the counterpoise as you have in the aerial.

The Leader Three

"I am considering building your Leader Three which was given some time ago, but before doing so should be glad to know whether it would be suitable for receiving the new Droitwich station. Also would it be possible to run the set from an H.T. eliminator."—J. R. H. (Barnehurst).

The receiver is perfectly suitable for the new Droitwich station, and it may be operated quite successfully from a good eliminator. If your particular unit is not adequately smoothed, there may be some instability, but this may easily be cured by inserting the usual decoupling circuits. We cannot give you details without knowing the type of unit.

Using a Side-terminal Pentode

"I have a four-pin pentode valve, with a terminal at the side. Could I use this in place of the five-pin valve which you specify for the Superhet Three? I should like to use the valve until I can get the specified one."—H. J. (Nottingham).

There is no objection to using the particular valve you mention, and it will only be necessary to take a short flexible lead from the centre-pin of the valveholder and to connect this to the terminal on the side of the valve. Unless the valve is of the same characteristics as the specified valve you will not, of course, obtain the same results.

An Extra H.T. Lead

"I have made a three-valve set, using S.G., detector, and power. The set is designed for batteries and there are three battery leads marked H.T.1, H.T.2, and H.T.3. I have built up an eliminator from a published circuit, but it gives S.G. screen, S.G. anode, power, and detector, which are four terminals. Please tell me where to connect the fourth terminal."—A. C. (Highgate, N.19).

You can ignore one of the terminals on the eliminator. You should use the power terminal for your H.T.3, the detector terminal for H.T.2, and the S.G. screen for H.T.1. If any instability arises, you

may find it desirable to break one of the H.T. leads in your receiver and employ a separate supply from the mains unit.

Changing to Mains

"I have a three-valve battery set, S.G., detector and pentode, and a commercial mains unit giving 150 volts at 28 mA and 4 volts at 2.5 amps. I should like to change over to all-mains valves and should like to know whether the set would require altering in any way; how to apply grid bias; and where to connect the centre-tap on the 4-volt winding."—W. B. (Surbiton).

It is quite possible that the receiver will be stable when mains valves are fitted, although you must remember that the higher efficiency of these valves generally means that the circuit requires a little more care in design. You should find that the indirectly-heated valves are most suitable, and bias is then applied by wiring a resistance of the correct value (as specified by the valve makers) in the cathode lead. This means that a five-pin valveholder must be used in place of the present four-pin valveholders, and the extra pin (in the centre) is the cathode pin. A suitable smoothing condenser should be connected across the bias resistance. The centre-tap of the 4-volt winding is then connected to earth. If, however, you employ a directly-heated output valve, the centre tap should be joined to earth through a suitable bias resistance.

An Extension Problem

"I have recently purchased a radiogram, and I propose to have an extension speaker in the dining-room. This will require about 40 ft. of wire. Will you please tell me what would be the best wire for the purpose without any loss of tone, etc.?"—W. A. K. (Mitcham).

The question of loss of tone is not bound up so much with the gauge of wire as with the circuit arrangement. If an output filter circuit is fitted then the length of wire will not affect volume or quality. Use single bell-wire in this case. If, however, the speaker is to be included direct in the anode circuit, a very heavy gauge of wire would be required and no voltage drop could be permitted.

THE QUERIES COUPON APPEARS ON COVER iii

PIX

THE WORLD'S HANDIEST AERIAL

A highly efficient self-adhesive strip Aerial that gives a wonderful pick-up clear of interference. Fixed in a jiffy without tools. Press it anywhere you want to run it and it sticks. Lightning proof, neat, efficient; just the thing for a modern home. PIX, London, S.E.1.

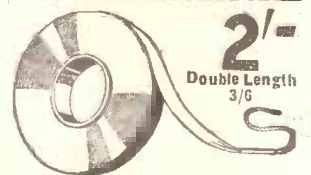

2/-
Double Length
3/6

PIX INVISIBLE AERIAL

Miscellaneous Advertisements

Advertisements are accepted for these columns at the rate of 3d. per word. Words in black face type and/or capitals are charged double this rate (minimum charge 3/- per paragraph). Display lines are charged at 6/- per line. All advertisements must be prepaid. Radio components advertised at below list price do not carry manufacturers' guarantee. All communications should be addressed to the Advertisement Manager, "Practical Wireless," 8, Southampton Street, Strand, London.

PREMIER SUPPLY STORES

ANNOUNCE a City Branch at 165 and 165a, Fleet St., E.C. (next door to Arderton's Hotel), for the convenience of callers; post orders and callers to High St., Clapham.

OFFER the Following Manufacturers' Surplus New Goods at a Fraction of the Original Cost; all goods guaranteed perfect, carriage paid over 5/-, under 5/- postage 6d. extra, I.F.S. and abroad, carriage extra. Orders under 5/- cannot be sent C.O.D. PLEASE SEND FOR ILLUSTRATED CATALOGUE POST FREE.

STUPENDOUS Purchase of Set Manufacturers' Stock. All electric 3 Valve (S.G. Det. Pen.) Set in Walnut Cabinet with moving-coil speaker, 200-250 volt, 40-60 cycles. Chassis built. 200-2,000 metres with 4 valves, £4/19/6.

ALL Electric 3-stage Amplifiers, 200-250v., 40-60 cycles, 10 watts, undistorted output, complete with 5 valves, and Magnavox Super "66" Speaker, £12/10/0.

TYPE 4480, 9in. diameter, permanent magnet Handles 4 watts, 7 ohms speech coil, 13/6. Multi-ratio transformer, 4/6 extra.

BLUE SPOT Moving Coil Speaker, 2,500 ohms Universal Transformer, 9/11.

PREMIER SUPPLY STORES announce the Purchase of the Complete Stock of a World Famous Continental Valve Manufacturer; all the following standard mains types, fully guaranteed, 4/6 each, H.L., L., Power, High, Medium, Low magnification, Screen Grid 250v., 60 m.a. rectifier. Directly heated Pentodes, 1 watt, 3 watt and 4 watt A.C. outputs. Universal A.C./D.C. types, 20v., .18 amp. Variable-mu Screen Grid, H.L., Power.

THE following Type, 5/6 each; 350v. and 500v., 120 milliamper full wave rectifiers 2½ watt indirectly heated pentode.

THE following American Types at 4/6; 250, 227, 112, 171, 210, 245, 26, 47, 24, 35, 58, 55, 37, 281, 80 and the following types, 6/6 each: 42, 77, 78, 2525, 36, 38, 83, 39, 44, 53, 6B7, 2A5, 2A6, 2A7, 2B7, 5Z3, 6C6, 6A4, 6D6, 6F7.

ELIMINATOR Kits, including transformer, choke, Westinghouse metal rectifier. Condensers, resistances and diagram, 120v., 20 m.a., 20/-; trickle charger 8/- extra; 150v., 30 milliamps, with 4v., 2-4 amps. C.T., L.T., 25/-; trickle charger, 6/6 extra; 250v., 60 milliamps with 4v., 3-5 amps. C.T., L.T., 30/-; 300 v. 60 m.a., with 4 volts, 3-5 amps., 37/6; 200v. 50 m.a., with 4 v. 3-5 amps. L.T., 27/6. D.C. Eliminator Kits, 120v., 20 m.a., 8/6; 150v., 30 m.a., 10/6.

PREMIER chokes, 40 milliamps, 25 hys., 4/-; 65 milliamps, 30 hys., 5/6; 150 milliamps, 30 hys., 10/6; 60 milliamps, 80 hys., 2,500 ohms, 5/6; 25 milliamps, 20 hys., 2/9.

ALL Premier Guaranteed Mains Transformers have Engraved Terminal Strips, with terminal connections, input 200-250v., 40-100 cycles, all windings paper interleaved.

PREMIER H.T. 7 Transformer, output 135v. 80 m.a., for voltage doubling, 8/6; 4v. 3-4a., C.T. L.T. 2/- extra; with Westinghouse rectifier giving 200 v. 30 m.a., 17/6.

PREMIER H.T.8 and 9 Transformers, 250v. 60 m.a. and 300v. 60 m.a. rectified with 4v. 3-5a. and 4v. 1-2a., C.T., L.T. and screened primary, 10/-; with Westinghouse rectifier, 18/6.

PREMIER H.T. 10 Transformer, 200v. 100 m.a. rectified with 4v. 3-5a., and 4v. 1-2a., C.T., L.T. and screened primary, 10/-; with Westinghouse rectifier, 19/6.

PREMIER Mains Transformer, output 250-0-250v. 60 m.a., 4v. 3-5a., 4v. 2-3a., 4v. 1-2a. (all C.T.) with screened primary, 10/-.

PREMIER Mains Transformers, output 350-0-350v. 90 m.a., 4v. 3-5a., 4v. 2-3a., 4v. 1-2a. (all C.T.) with screened primary, 10/-.

PREMIER Auto Transformers, 100-110/200-250v. or vice versa, 100-watt, 10/-.

WESTERN ELECTRIC Mains Transformers, 300-0-300v. 65 m.a., 4v. 1-2a., 4v. 2-3a., 6/6; 500-0-500v., 150 m.a., 4v. 3-5a., 4v. 2-3a., 4 v. 2-3a., 4v. 1a., C.T., 4v. 1a. C.T., 19/6.

SPECIAL Offer of Mains Transformers, manufactured by Phillips, input 100-200v. or 200-250v. output 180-0-180 volts 40 m.a., 4v. 1 amp., 4v. 3 amps., 4/6.

PREMIER L.T. Charger Kits, consisting of Premier transformer and Westinghouse rectifier, input 200-250v. A.C., output 8v. 1 amp., 14/6; 8v. 1 amp., 17/6; 6v. 2 amp., 27/6; 30v. 1 amp., 37/6; 2v. 1 amp., 11/-.

T.H. Truspeed Induction Type (A.C. only) Electric Gramophone Motors. 100-250v.; 30/- complete.

(Continued at top of column three)

Easy Terms

Why wait weeks for that new Radio accessory? You'll get it quicker from N. T. S. Any items advertised in this journal on Easy Terms. Strict Privacy Guaranteed. Cash or C.O.D. if preferred. Orders over 10/- carriage and C.O.D. Charges paid. SEND FOR QUOTATIONS FOR ANYTHING IN RADIO YOU ARE NEEDING.

TELSEN S.G.3 KIT

Complete kit of parts for building, less Valves. Send only 2/6. Balance in 8 monthly payments of 5/-. Cash or C.O.D. Carriage Paid, £1/19/6. If Valves required, add £11/1/6 to Cash Price, or 5/- deposit and 11 monthly payments of 6/6.



WESTENTORIAN SENIOR

SENT ON 7 DAYS' TRIAL Type PMS1. For Power, Pentode and Class B. Send only 2/6 for 7 days' trial. If approved, balance in 11 monthly payments of 4/-. Cash or C.O.D. Carriage Paid, £2/2/0. W.B. Stentorian Standard. Cash in 7 days, £1/12/6, or 2/6 deposit and 11 monthly payments of 3/-. W.B. Stentorian Baby. Cash in 7 days, £1/2/6, or 2/6 deposit and 9 monthly payments of 2/6.

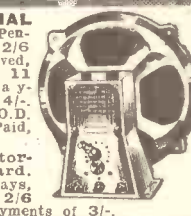

GRAHAM FARISH RAIDER 3 KIT

Complete Kit of parts for building, less valves and cabinet. Send only 5/-. Balance in 11 monthly payments of 6/3. Cash or C.O.D. Carriage Paid, £3/7/6. If valves and cabinet required, add £2/16/6 to Cash Price, or complete 10/- deposit and 11 monthly payments of 11/6.



EXIDE ACCUMULATORS

SENT ON 7 DAYS' TRIAL 2 - W.H.60. 120 volts. 5,000 m.a. In wooden crates. Send only 8/- for the pair on 7 days' trial; if approved, balance in 11 monthly payments of 8/6. Cash or C.O.D. Carriage Paid, £4/13/0.

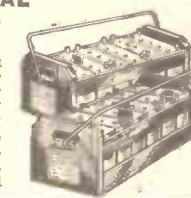

Peto-Scott 1935 BATTERY 3

With Peto-Scott Moving-Coil Speaker, screened coils, British Valves, Oldham H.T. and L.T. Batteries, fullaerial equipment, modern cabinet. Send only 5/- balanced in 18 monthly payments of 6/6. Cash or C.O.D. Carriage Paid, £4/19/6.



New Times Sales Co.

56, LUDGATE HILL, LONDON, E.C.4.

Dear Sirs,

(a) Please send me.....

(b) I enclose Cash/Deposit.....

NAME

ADDRESS

Pr.W. 17/11/34

FIRST WITH EASY TERMS IN 1924

(Continued from foot of column one)

COLLARO Gramo. Unit consisting of A.C. motor 200-250v. high quality pick-up and volume control 49/-; without volume control, 46/-.

SPECIAL Offer. American Midget Superhet., A.C./D.C., 100/250v., 25/60 cycles, 4 valves, including Rectifier, 200/550 metres, £3/19/6.

SPECIAL Offer of Wire Wound Resistances, 4 watts, any value up to 50,000 ohms, 1/-; 8 watts, any value up to 15,000 ohms, 1/6; 15 watts any value up to 50,000 ohms, 2/6; 25 watts, any value up to 50,000 ohms, 2/6.

CENTRALAB Potentiometers, 50,000, 100,000 1/2 meg. any value, 2/-; 200 ohms. wire wound, 1/-.

EDISON Bell Double Spring Gramophone Motors, complete with turn-table and all fittings, a really sound job, 15/-.

WIRE Wound Potentiometers 1,000, 2,500, 50,000, 90,000, 150,000, 200,000, 500,000, any value. 2/- each. 1,000 ohms wire-wound semi-variable resistances, carry 150 m.a., 2/-.

POLAR Star, manufacturers' model, 3-gang condensers, fully screened, with trimmers, 7/6; unscreened, 5/-.

BRITISH Radiophone 110 kc/s Intermediates, 3/-.

Cosmocord Pick-ups, with arm and volume control, 12/-.

AMERICAN Triple Gang 0.0005 Condensers, with trimmers, 4/11; Utility Bakelite 2-gang 0.0005 screened with uniknob trimmer, 3/6; Polar Bakelite condensers, 0.00035, 0.0003, 0.0005, 1/-.

MAGNAVOX D.C. 152, 2,500 ohms, 17/6; D.C. 154, 2,500 ohms, 12/6; D.C. 152 magna, 2,500 ohms, 37/6, all complete with humbucking coils; please state whether power or Pentode required; A.C. conversion kit for above types, 10/-; Magnavox P.M., 7in. cone, 16/6.

RELIABLE Canned Coils with Circuit accurately matched, dual range iron-cored, 3/6.

RELIABLE Intervalve Transformers, 2/-; multi-ratio output transformers, 4/6.

C.C. Electrolytic Condensers, 8 mf. 440v. working, 3/-; 15 mf. 50v. working, 1/-; 6 mf. 50v. working and 2 mf. 100v. working, 6d.; 8+4 mf., 450v. working, 4/-; 50mf. 12v., 1/-; 25mf. 25v., 1/-; 15mf. 100v., 1/6.

C.C. Condensers, 250v. working, 1 mf., 1/3; 2 mf., 1/9; 4 mf., 3/-; 4 mf., 450v. working, 4/-; 4 mf., 750v. working, 6/-.

BRITISH Insulated Cables Condensers 50 mf. 50v. 2/9; 8 mf. 550v. Peak Working, 3/6.

10,000 12,000, 15,000 ohm, wire-wound Potentiometers with mains switch 1/6.

GRAMPIAN Permanent-Magnet Moving Coil 9in. Diameter, handles 4 Watts, Universal Transformer, 18/6. Energised 5,200 ohms, handle 5 Watts, 21/-.

WESTERN ELECTRIC Condensers, 250v. working, 1mf., 6d., 2 mf., 1/6; 4 mf., 2/-; 400v. working, 1 mf., 1/-; 2 mf., 1/6.

H.M.V. Condensers, 400v. working; 4x2x1x1x1x1 x 1x0.5, 3/9; Phillips 300v., 6x4x2x1x1x1, 4/6.

DUBILIER Condensers, 8 or 4 mf. d. dry electrolytic 450v. working, 3/-; 4x4x2x0.1, 3/6.

VARLEY Constant square Peak Coils, band-pass type BP7, brand new in maker's cartons with instructions and diagrams, 2/4.

VARLEY H.F. Intervalve Coils BPS band-pass complete with instructions in original cartons, 2/6.

SCREENED H.F. Chokes by One of the Largest Manufacturers in the Country, 1/6.

PREMIER British-made Meters, moving iron flush mounting, accurate, 0-10, 0-15, 0-50, 0-100, 0-250 m.a., 0-1, 0-5 amps., all at 6/-.

LARGE Selection of Pedestal, table and radio-gram cabinets, by best manufacturers at a fraction of original cost, for callers.

THE Following Lines 6d. each or 5/- per dozen.— Chassis valveholders, 5-, 6-, or 7-pin screened screen grid leads, any value 1-watt wire end resistances wire end condensers, 0.0001 to 0.1 Bulgin 3 amp. main switches. Cydon capacitors, double trimmers.

UTILITY 3-gang Condensers, completely screened, U with trimmers, ball-bearing, 6/9; with complete slow-motion dial, 7/11.

BRITISH Radiophone, 2-gang, screened, with trimmers and complete slow-motion dial, 5/6.

PREMIER SUPPLY STORES 20-22, High St., Clapham, S.W.4. Telephone: Macaulay 2188. Nearest Station, Clapham North Underground.

10/6 Only 11—Brand New Manufacturers Surplus Moving Coil Speakers; by one of the best-known British makers; energised, 2,500 or 6,500 ohms field, power or pentode transformer, 8in. cone; 10/6 each.

12/6 Only 11—As above, but 10in. cone; 12/6 each.

15/6 Only 11—Permanent magnet with power or pentode transformer, 8in. cone; 15/6 each.

17/6 Only 11—As above, but with 10in. cone; 17/6 each.

CABINET for Any of Above, 2/9 each only; secure one of these amazing bargains now; cash with order or c.o.d.—Hulbert, 8, Conduit St., W.1.

HIGHEST possible allowance made on used wireless goods in exchange for new sets, components, or Peto-Scott kits. All latest receivers supplied on easiest of terms.—E. Wigfield, Furlong Road, Goldthorpe, Yorks.

RADIO CLEARANCE, 280, High Holborn, W.C.1, offers the following stupendous bargains; limited quantities only; all orders over 5/- carriage free.—Phone: Holborn 4631.

The following components are suitable for F. J. Camm's £5 Three-Valve Super Het.

RADIO CLEARANCE Offers British Radiophone Triple Gang Condensers, 2x0.0005 and 110 K/c oscillator section, complete with knob, drive and escutcheon; 7/6.

RADIO CLEARANCE Makes special offer of Dorchester S.T. 600 Sealed Kits, limited quantity only to designer's specification, including Formo ganged condensers, Colvern coils, Polar condensers, T.C.C. fixed condensers, panel drilled to specification, methylated baseboard drill terminal strip. List price £5/17/0, our price £3/10/0. Order early to secure one.

RADIO CLEARANCE Offers "Centralab" Potentiometers, 25,000, 50,000 ohms; 1/6 each.

RADIO CLEARANCE Offers L.F. Transformers, 3:1 and 5:1, manufacturers' type, 1/6 each.

RADIO CLEARANCE Offers Set of Resistances comprising 160 ohm, 100,000 ohm, 30,000 ohm, 1/6 set.

RADIO CLEARANCE Offers the Dorchester 3-valve battery chassis completely wired, brand new. Screen grid detector and pentode. All first-class components, price 35/-, less valves. Post free.

RADIO CLEARANCE Offers Radiophone 110 K/c. Intermediate Frequency Transformers; 3/6.

RADIO CLEARANCE Offers 8,000 ohm Volume Controls, log. type, with Q.M.B. switch, by G.E.C.; 2/6.

RADIO CLEARANCE Offers L.F. Transformers, 3:1 and 5:1, manufacturers type, 1/6 each.

RADIO CLEARANCE Offers Mains Transformers, unshrouded, manufacturer type, primary 200-250, secondary 320-0-320v. at 70 m.a., 2-0-2v. at 2 1/2 amps., 2-0-2v. at 3 amps.; 8/6.

RADIO CLEARANCE Offers Mains Transformers, shrouded, with terminals, primary 200-250v., secondary 320-0-320v. at 70 m.a., 2-0-2 at 2 1/2 a., 2-0-2 at 4 1/2 a., 9/6.

RADIO CLEARANCE Offers Mains Transformers, shrouded, with terminals, primary 200-250v., secondaries 320-0-320 at 70 m.a., 2-0-2 at 2 1/2 a., 2-0-2 at 4 1/2 a., 10/6.

RADIO CLEARANCE Offers Steel Chassis cadmium plated, drilled ready for use, 3-valve, or 7-valve type; 1/6.

RADIO CLEARANCE Offers 2, 3, and 4 valve metal chassis complete with valveholders and terminal strips, 2/6 each.

RADIO CLEARANCE Offers Set of Band-Pass Coils, manufacturer's type, with circuit diagram, suitable for tuned grid or tuned anode; set of 3 coils, 4/6.

RADIO CLEARANCE Offers Parallel Feed Transformers, ratio 6-1, by well-known manufacturer, 3/6.

RADIO CLEARANCE Offers T.C.C. Condensers, 0.5 mfd. 800-volt D.C. working 1/6 each; T.C.C. condensers, 1 mfd., 250-volt, D.C. working, 1/- each; T.C.C. condensers 1 mfd. 450-volt D.C. working, 1/3 each; T.C.C. condensers, 1 mfd. 800-volt, D.C. working, 2/- each; T.C.C. condensers, 2 mfd. 450-volt, D.C. working, 2/- each; T.C.C. condensers, 6 mfd., 250-volt D.C. working, 3/- each; T.C.C. condensers, 4 mfd. block 0.5, 0.5, 0.5, 0.5, 0.5, 0.5 and 1 mfd. 250-volt A.C. working, 2/- each.

RADIO CLEARANCE Offers Phillips Eliminator Transformers, 150 volts at 30 milliamperes, 4 volts, 1 amp., various inputs, 1/6.

RADIO CLEARANCE Offers L.F. Transformers (shrouded), 3:1 and 5:1. Price, 1/9 each.

RADIO CLEARANCE Offers Magnacore Class B Chokes. Price, 2/11.

RADIO CLEARANCE Offers Magnacore Q.P.P. Choke. Price, 2/11 each.

RADIO CLEARANCE Offers 1/25th h.p. Motors (Gilbert), 100-115 volts A.C., for Television. Suitable for 200-250 volts if used with 700 ohm resistor or 30 watt lamp. Price 12/6 each.

RADIO CLEARANCE Offers Variable Power Resistances by well-known maker, 0.100 ohms. Price 3/- each. Exceptional value.

RADIO CLEARANCE offers sleeving 1 1/4" m at 9d. per dozen lengths.

RADIO CLEARANCE offers Wego 2 mfd. condensers, 9d. each.

WANTED, good modern wireless parts, sets, eliminators, meters, valves, speakers, etc. Spot cash waiting. Exchanges. Send or bring. We pay more than any other dealer. Open 9-8.—University Radio, 142, Drummond St., Euston, N.W.1.

F. J. CAMM'S £5 Super-Het Three specified Kit 70/- (7/7 monthly). ST. 600 66/8 Complete Kit, Lists Free.—"Melfo-Rad," Queen's Place, Hove. (Trade supplied).

RADIALADDIN (Disposals) Ltd. Exchange your old set for any new model, balance cash or H.P. Write for free quotation to largest radio exchange in U.K. Also clearance sale of reconditioned sets and radiograms at gift prices £1 to £10. Write for list.—40, Brewer Street, Piccadilly Circus, W.1. Gerrard 4055.

ALL REPAIRS to Moving Coil Speakers, and prices quoted. Loud-speakers, L.F. and Speech Transformers 4/- each. Post free. Satisfaction guaranteed. Prompt service.—L.S. Repair Service, 5, Balham Grove, London, Batterser 1321.

WOBURN RADIO offer following bargains. Avoid delay by sending orders without money, we pay C.O.D. charges on orders over 5/-.

WESTINGHOUSE Rectifiers: H.T.8 and 9, 8/11. Transformers for use with H.T. 8 and 9, with L.T. tappings, 6/9 (carr. 9d.) (ex Regentone). Gilbert Motors, suitable for television, 1/25th h.p., 110-115v. A.C. suitable for 200/50v. with 700 ohm resistor or 30 watt lamp, 15/- each.

SONOCORDE speakers, D.C. 2,000, brand new and boxed, 12/6, carr. 1/-.

Polar Midget Condensers (1935 model), 0005 fully screened with trimmers, 2-gang 0/6, 3-gang 9/9.

British Radiophone dials, semi curved, with twin dial lights and escutcheon, 3/9.

CONDENSERS: Formo 2 mfd., 1,000-v. test, 1/3. 1 mfd., 800-v. test, 1/-.

WATCH for new purchase of T.C.C. condensers next week, delivery expected November 9th, so write your requirements for all types.

TRADE list now ready, please enclose heading and stamp.

WOBURN RADIO CO., 9, Sandland Street, Bedford Row, W.C.1, Holborn 7289, Second Floor. Just off Holborn, or Red Lion Street.

WONDERFUL BARGAIN - 24 ONLY Peto-Scott 1935 Walnut ADAPTARAM BRAND NEW 47/6. Includes image of a radio chassis and contact information for Peto-Scott Co. Ltd.

VAUXHALL.—Magnavox Permanent Magnet Loudspeakers, universal, suitable for Class B power or pentode; 7in. cone, 17/6; 10in. cone, 23/-.

VAUXHALL.—All new with humpbacking coils. 15/3. All new with humpbacking coils.

VAUXHALL, U.S.A. Bola Energised Sin. diameter, 2,500, 6,500 ohms, 17/6; 10in. diameter, 25/-; P.M. Sin. diameter, 28/-; 10in. diameter, 33/-.

VAUXHALL.—Radiophone Radiopaks, Band-pass superhet, with Lucerne wavelength station-named scales, medium and long, complete, 32/6.

VAUXHALL.—Radiophone I.F. transformers, with terminals, 6/-. Radiophone volume controls, with switch, 3/6.

VAUXHALL.—Three-gang condensers, with covers—superhet., 14/6; ordinary type, 12/6. Disc drives, complete, 4/9.

VAUXHALL.—Pick-ups. Write for quotation. State make, B.T.H. Collaro Motors, 32/6. Gramophone switches, 3/6.

VAUXHALL.—Westinghouse Rectifiers. H.T.8 9/6; H.T.9, 10/1; Westectors, W4, WXG, 5/9.

VAUXHALL.—Dubilier 4-8mfd. Electrolytic Condensers, 3/6; Mains Transformers, suitable for V.T.8, with terminals, 11/6.

CASH with Order, post paid over 2/6, or c.o.d.; all goods unused manufacturers' surplus; guaranteed perfect. Lists free.

VAUXHALL UTILITIES, 163a, Strand, W.C.2, Phone: Temple Bar 9333. (Facing Bush House, over Denny's.)

ALL goods advertised in last week's issue still available.

WARD, 2nd floor, 45, Farringdon Street, London, E.C.4. Telephone: Holborn 9703.

MAINS Transformers, chokes, etc., to specification; repairs promptly executed. Guaranteed satisfaction. Prices on request. Henry Peace, Ltd., Wednesbury, Staffs.

SOUTHERN RADIO'S WIRELESS BARGAINS. RECEIVERS.—G.E.C. Osram Four-valve (Actual) Sets. Complete with four Osram valves, permanent magnet moving-coil speaker. Magnificent pedestal cabinet. Ready to use on all voltages. A.C. all Osram proprietary components in original sealed cartons, £6/15/- (list £15/15/-). An exceptional bargain.

BOTOLPH Lightweight Portables, complete with 5 valves, Exide batteries and accumulators, £2/19/6 (list £8/8/-); a real suitcase portable.

COLLS.—Igranic Super-het Set of Four (1 osc., 2 I.F. with Pigtails, 1 L.F. Plain), 12/6 (list 50/-). Lissen Superhet three coil Kit. Screened Ganged on Base with switch. Type L.N. 5181, 9/6. Same description for Band Pass or any other circuit. Type L.N. 5102, 7/-.

VARLEY Constant Square Peak Coils B.P. 5, complete with all accessories in sealed cartons 2/3.

LEWCO'S B.P.F.R. T.B.F./C, O.S.C./126 (Extensor) T.O. 8/8, all at 3/6 each. A full range of Edison Bell plug-in coils, two-pin, at 9d. each.

PICK-UPS.—Marconi Model K. 25 (1935 issue), 22/6 (list 32/6); Six only Rothenmel Piezo Electric Pick-ups, 35/-; Four only B.T.H. Senior Pick-ups, 32/6.

CONDENSERS.—Lotus, 3-gang, 12/6; 2-gang, 8/6; Single Dyblock, 4/6. All capacity 0.0005. Fully screened with trimmers, complete with dials, knobs and escutcheons. Special bargain line. Plessey four-gang condensers, superhet type. Fully screened with trimmers (less dials), standard dial will fit, 10/6 (list 45/-).

DUBILIER Block Condensers, 4 mfd. (2 x 1 x 1) 1,000-volt, 2/9; 4.5 mfd (2.25 x 2.25), 3/-; T.C.C. (0.1 x 0.01), 1/3 each.

SPEAKERS.—Rothenmel Permanent Magnet Moving-Coil Universal Transformer, 16/- (7in. cone); Blue Spot Permanent Magnet Speakers Universal Transformer, for Power, Super Power, Pentode and Class B, 23/-; Blue Spot 66R Units, brand new and boxed, 10/6 (list 35/-), complete mounted on Blue Spot Chassis, 16/6 (list 45/-).

MISCELLANEOUS.—Westinghouse Metal Rectifiers, H.T. 6, 7, 8, 9/3. Morse Tapping Keys with flash signal and buzzer, complete with battery and bulb, 2/-.

LISSEN General Purpose Output Chokes, 20/28 henries, 18/60 m.a., L.N. 5301, 6/- each.

LEWCO'S Superhet, dual wave frame aerials, 9/-.

THOUSANDS of other bargains. Callers are assured of a tremendous saving in all branches of wireless needs by visiting any of our shops. All 1935 receivers can be supplied on the most favourable hire-purchase terms.

ALL goods guaranteed and sent post paid.

BRANCHES at 46, Lisle Street, W.C.2; 16, Leicester Street, W.; 271/175, High Road, Willesden Green, N.W.10. All Mail Orders to 323, Euston Road, N.W.1.

SOUTHERN RADIO, 323, Euston Road, London, S.W.1. (near Warren St. Tube). Phone: Museum 6324.

PEARL & PEARL 190, Bishopsgate, London, E.C.2. All the following bargains guaranteed new goods. Cash or C.O.D. Carriage Paid. SPECIAL OFFER. Lissen 3-ganged superhet coil units for A.C. or battery sets; with circuits and diagrams. Over 250 already sold to "P.W." readers. List price 30/-, now offered at special price 6/6 only. SPEAKERS. Lissen Plaque Loud-speakers. Wonderful tone. List 15/-. Our price 5/11. AMPLION Class B Driver Transformers, 1-1, 1.5-1, or 2-1. Specially large core, as listed at 9/6. Our price 5/6. Amplion Class B Output Chokes, tapped 1-1, 1.5-1 and 3-1. Ideal for matching n/c speakers. List 9/6. Our price 5/6. SPEAKER UNITS. TRIOTRON 4-pole balanced armature speaker Units, type "B"; sensitive, beautiful tone. List 22/6. Our price 6/11. LUCERNE COILS. NEW LUCERNE dual-range coils 1/8 each. Screened ION Cored Dual coils with circuits, 1/11 each. CONDENSERS. IGRANIC 2-gang variable condensers .0005 mfd, each side. Complete with trimmers and dust cover; can be fitted on baseboard or panel. List, 17/6. Our price, 6/9. AMPLION Binocular H.F. Chokes. Totally enclosed in bakelite case. List, 4/6. Our price, 2/9. COLUMBIA 2-Valve Battery Receivers with Speaker and Marconi valves, in attractive Oak cabinet. List 4 gns. Our price 32/6. Carriage forward. CABINETTS TELSEN WALNUT receiver cabinets. Well made and highly polished. Size 16in. high, 14 1/2in. wide, 9 1/2in. deep. Limited quantity to clear at 8/11 each, carriage forward.

SPECIAL SUNDRY BARGAINS (Cash with order only) LOTS of 3 dozen assorted Dubilier fixed condensers, 1/9 each lot. 4-pin Chassis mounting Valveholders, 5d. each; 6 for 2/-; 7-pin type, 7d. each, 6 for 3/-. Variable tuning condensers .0003 mfd. 1/- each. Igranic 2-pole rotary switches, 1/- each. Igranic Short-wave chokes, 1/- each. Double reading voltmeters, 1/9 each. Accumulator Hydrometers, complete with float, 1/- each. Sovereign lightning arresters, 6d. each.

All Mail Orders Direct to PEARL & PEARL, 190, Bishopsgate, London, E.C.2. Tele.: Bishopsgate 1212.

There's plenty of life
in me yet. Look at
my 'Indicator'!

I tell you in time when it's time to recharge me. I warn you or reassure you—you always know from a glance at me exactly how my charge stands. I safeguard you from disappointment, and you can rely on what I say. Why run the risk of a run-down battery? Have an Exide 'Indicator.'

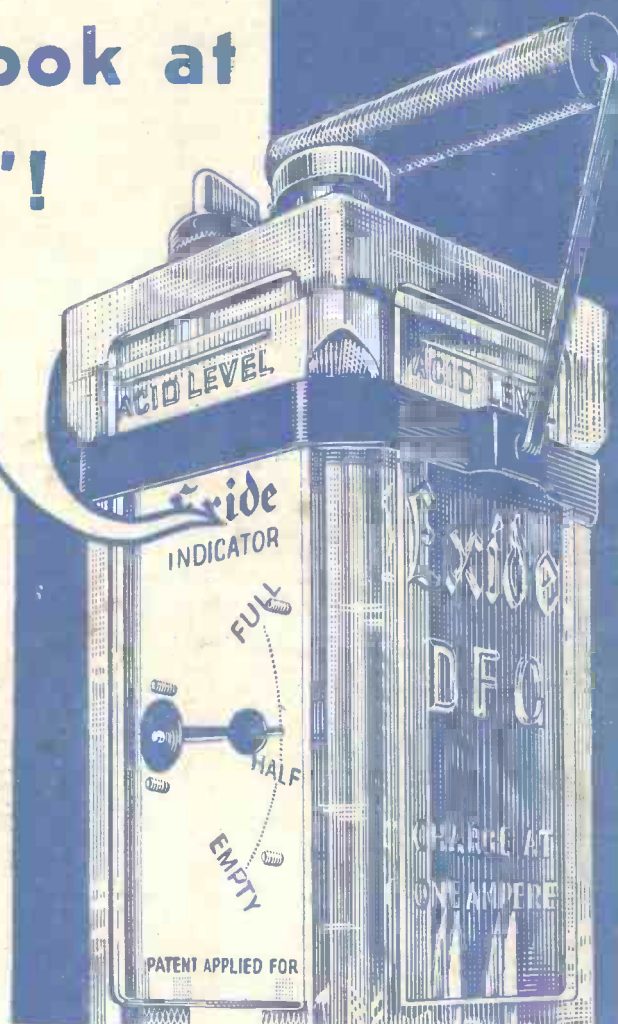

PRICES WITH 'INDICATORS'

Type DTG-C 2 volt 20 a.h.	5/-
Type DFG-C 2 volt 45 a.h.	9/-
Type DXG-C 2 volt 58 a.h.	10/-
Type DMG-C 2 volt 70 a.h.	12/-
Type DHG-C 2 volt 100 a.h.	15/6

★ These prices do not apply to the Irish Free State.

Exide

"INDICATOR" BATTERY

For Wireless H.T. get **Drydex** the Exide dry battery

from Exide Service Stations and all good dealers • EXIDE BATTERIES, Exide Works, Clifton Junction, near Manchester
Branches: London, Manchester, Birmingham, Bristol, Glasgow, Dublin and Belfast.

R.80.

"STILL KEEP GOING WHEN THE REST HAVE STOPPED"

T9

See p. 209

AB-4

Printed in Great Britain by NEWNES & PEARSON PRINTING CO., LTD., Exmoor Street, Ladbroke Grove, W.10, and published by GEORGE NEWNES, LTD., 8-11, Southampton Street, Strand, W.C.2. Sole Agents for Australia and New Zealand: GORDON & GOTCH, LTD. South Africa: CENTRAL NEWS AGENCY, LTD. *Practical Wireless* can be sent to any part of the world, post free, for 17/4 per annum; six months, 8/8. Registered at the General Post Office for Transmission by Canadian Magazine Post.