

ADAPTING YOUR SET TO THE NEW WAVELENGTHS

Practical Wireless

3^d

Published every Wednesday by

**GEORGE
NEWNES
LTD.**

Vol. 3.—No. 74.

FEBRUARY 17th, 1934.

Registered at the G.P.O. as a Newspaper.

AND PRACTICAL TELEVISION

EDITED BY F.J. CAMM

BUILDING THE
"PRACTICAL WIRELESS"

MIRRORVISOR

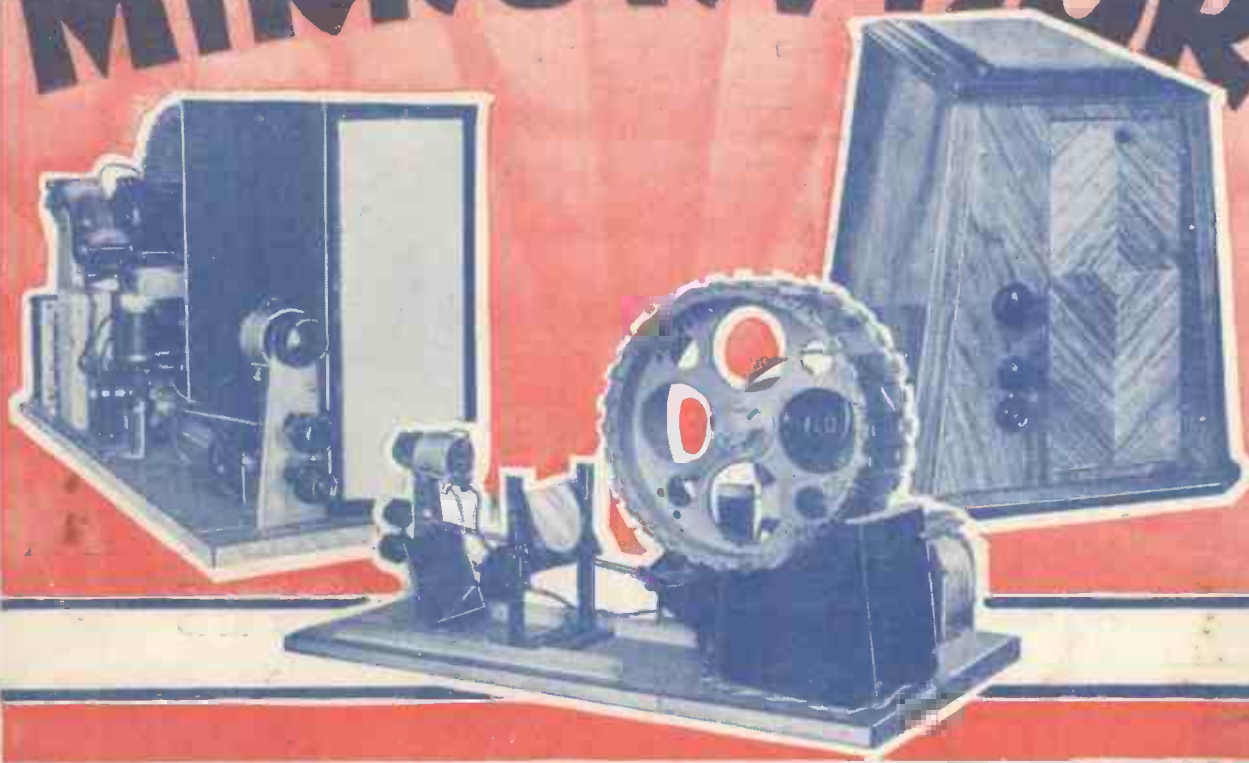

THE WORLD'S HANDIEST AERIAL

**SELF ADHESIVE
BEST PICK-UP
NEATEST**

A revolutionary idea in Aerials. Just unroll the tape and press it up in position around the room or up to the attic—and it sticks. One pull and it's down and leaves no mark. No danger from lightning, reduces static interference and increases selectivity. Ideal for artistic homes. Excellent pick-up for flats. Obtainable everywhere. British Pix Co., Ltd., London, S.E.1.

PIX INVISIBLE AERIAL

2/-
DOUBLE LENGTH 3/6

UNIFORMITY EFFICIENCY RELIABILITY

BETTER RADIO RECEPTION

Be a critic for once. Switch on your Set and listen—listen critically. Is the bass rich and full—is the treble brilliant, clear cut? Can you get the volume you want? And will it bring in the stations it used to?

It's a simple matter to make your Set like new again. You can easily give it a new lease of life. With the right types of Cossor Valves (your dealer knows them) you can improve its performance out of all recognition—it's surprising what a difference they make.

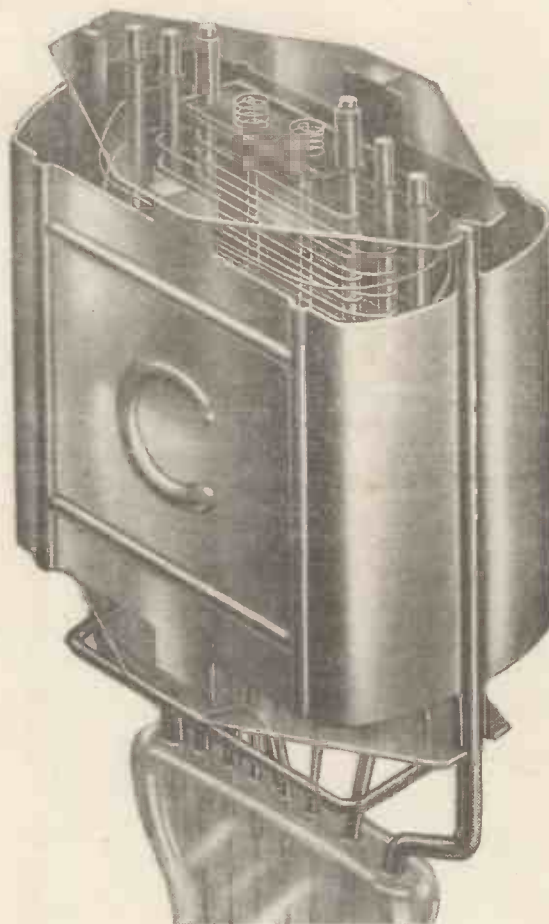

NEW STATION CHART

Get one of the new Cossor Station Charts which gives the revised wavelengths, etc., of over 80 foreign stations and has space for entering your own dial readings, price 2d. from your Dealer or write to A. C. Cossor Ltd., Melody Dept., Highbury Grove, London, N.5, enclosing 2d. stamp.

FREE!

72-PAGE WIRELESS BOOK

From cover to cover this new Cossor 72-page Wireless Book is packed full of useful and interesting information—latest circuits—explanations of technical terms—list of broadcasting stations, etc. Send at once for free copy. Please use the coupon.

COSSOR VALVES

To A. C. COSSOR LTD., Melody Dept., Highbury Grove, London, N.5

Please send me free of charge, a copy of the Cossor 72-page Wireless Book.

Name.....

Address.....

B.V.33-

FRAC. 17/2/34



KINGS OF THE AIR

A. C. Cossor Ltd., Highbury Grove, London, N.5. Depots at Birmingham, Bristol, Glasgow, Leeds, Liverpool, Manchester, Newcastle, Sheffield, Belfast, Cardiff and Dublin.

CAN RECEIVER DESIGN BE IMPROVED? SEE PAGE 1013



Practical Wireless
 & PRACTICAL TELEVISION

EDITOR:
 Vol. III. No. 74 || F. J. CAMM || Feb. 17th, 1934
 Technical Staff:
 W. J. Delaney,
 H. J. Barton Chapple, Wh. Sch., B.Sc. (Hons.), A.M.I.E.E.,
 Frank Preston, F.R.A.

ROUND *the* WORLD of WIRELESS

More Statistics

ALTHOUGH at the end of 1933 Great Britain was holding the lead as regards the number of licensed listeners, in actual percentage of increase during the year Switzerland established the record for Europe. With 68,651 additional licences to her credit the increase works out for the year at 29.6 per cent. as against 18.6 per cent. for Great Britain, 17.3 per cent. in Germany, 9 per cent. in Sweden and 7.2 per cent. in Denmark. The great gain made by Switzerland was mainly due to the opening of the Monte Ceneri transmitter.

Early Morning Broadcasts

RADIO PARIS is now on the air daily at 6.45 a.m. with physical exercises followed by a broadcast of gramophone records and a news bulletin. More records are played between 8 and 8.30 a.m. to liven up the Parisian listener's breakfast.

As You Were!

ALTHOUGH, with a view to effecting economies, the German stations had been amalgamated into three groups for the broadcast of a common programme, this policy is not to be continued. As in the past, the studios are to be decentralized and the regions will furnish their local entertainments.

The Modern Tower of Babel

WHEN the new Cairo (Egypt) transmitter is brought into operation on 483.9 metres (620 kilocycles), a channel to be shared with Brussels No. 1, it is expected that the broadcasts will be made in several languages. Egypt possesses a mixed population, and if the service is to be of general benefit to the population, the entertainments must be given out in tongues understood by Turks, Greeks, Armenians, Arabs, Copts, Fellahs, Syrians, and others, apart from the English, French, and German-speaking communities. A tall order for one studio!

Berlin's National Theatre

THE *Grosse Schauspielhaus*, one of Berlin's largest theatres, has been acquired by the National Socialist Government as a National Theatre. Seats for special performances which it is also intended to relay to the German broadcasting

stations are to be distributed free of charge to all unemployed members of the Nazi Party.

Death of Europe's Oldest Announcer

ADOLF DOBROVOLNY, of the Prague (Czecho-Slovakia) studio, who recently died in that city, was in age the *doyen* of European announcers. He was seventy years old, and had held the position since the opening of the first Prague station.

New York, for the broadcast of a concert given by an orchestra numbering four hundred instrumentalists, a sufficient "pick up" was secured by the use of only one microphone in the studio.

Touring the Halls

ON February 23rd, under the title of *Northern Music Halls on Parade*, listeners will be invited to join in a microphone tour of the Argyle (Birkenhead), The Grand (Blackburn), and the Empire at both York and Middlesbrough-on-Tees. On the previous evening an old-time music-hall programme will be presented; it will offer the unseen audience memories of the old Palace (London).

Another Scrap Book Broadcast

THIS time, through the Regional (February 19th) and the National stations (February 20th) the B.B.C. will take us back twenty-five years, namely, to 1909, when Shackleton conquered the Antarctic regions, when Blériot accomplished his famous Channel flight, and when the Suffragettes were in their "prime." The programme will be presented by a cast including such well-known artists as Irene Vanbrugh, Lyn Harding, Harry Welchman and George Graves, who achieved great successes in the year under review. On the same nights John Galsworthy's play *Loyalties*, with Ernest Milton in his original rôle of de Levis, will also be transmitted.

New Rhineland Relay

ASITE has now been found at Bubenheimer Flesche near Coblenz for the new 1½ kilowatt relay transmitter which is to broadcast the Frankfurt programmes in the Upper Rhineland district. It will work on a wavelength common to that group, namely, 251 metres (1,195 kc/s).

A Little (Radio) Entente

IT is reported that Austria and Czecho-Slovakia have come to an agreement by which both countries have pledged themselves to abstain from broadcasting any kind of propaganda likely to hurt their mutual feelings. An attempt is also to be made to effect a similar arrangement with other Balkan states.

**IT IS CHEAPER
 TO BUILD THAN
 TO BUY!**

¶ But only when you are Sure of Results!

¶ We Guarantee Our Receivers under a Free Advice Warranty!

¶ We do not specify alternatives! "Practical Wireless" exists to Serve its Readers!

¶ It Leads and Shows the Way!

Another U.S.A. Super

IN addition to the early morning tests carried out by the new Cincinnati 500-kilowatt station on 428.3 metres, listeners may now pick up test transmissions made by KDKA, East Pittsburgh, on 305.9 metres, with a power of 400 kilowatts. The best time to make a search for this new-comer is between 7 and 9 a.m. G.M.T.

The Sensitivity of Microphones

THE new ribbon type of microphone now used in the most up-to-date studios is a vast improvement over the older types. Its sensitivity is much greater and it possesses the additional advantage of picking up sounds from two sides. The benefit derived from this quality is proved by the fact that at Radio City,

ROUND *the* WORLD of WIRELESS (Continued)

Sender Oesterreich

VIENNA has decided to alter its call; it is no longer to be known as Radio Wien (*Veen*), but as *Sender Oesterreich*, in opposition to the *Deutschlandsender* which represents the Voice of Germany. The station is to be used to the full limit of its power, and in addition it is also proposed to increase the output of Linz and Klagenfurt, which relay the capital programmes, from 2 to 5 kilowatts. The old Rosenhugel transmitter is to be dismantled without delay and re-erected as quickly as possible at Graz; its power is 17 kilowatts.

INTERESTING and TOPICAL PARAGRAPHS

Those people who imagine that Lohengrin's *Wedding March* is a march pure and simple, will probably be surprised to hear it being sung by the Belfast Wireless Chorus. The programme includes three choruses by Wagner, one by Mozart, and one by Weber. E. Godfrey Brown will be the conductor.

Flower of a Thousand Nights, by Walford Hyden; Geoffrey Dams plays the Mandarin; Marjorie Westbury, his disobedient daughter; Godfrey Baseley, her lover; and Sheila Crocker, her maid. *The Old Lady shows her Muddles* is a little comedy about a padre's wife who gets up modern slang for the benefit of the younger generation, and does so from a dictionary with dire effects! Sheila Crocker plays the old lady. A tense piece called *The Lighthouse* has two characters only—lighthouse-keepers, who are played by John Lang and Godfrey Baseley. The author is J. C. Cannell.

FAMOUS SKATING RINK FOR B.B.C. STUDIOS

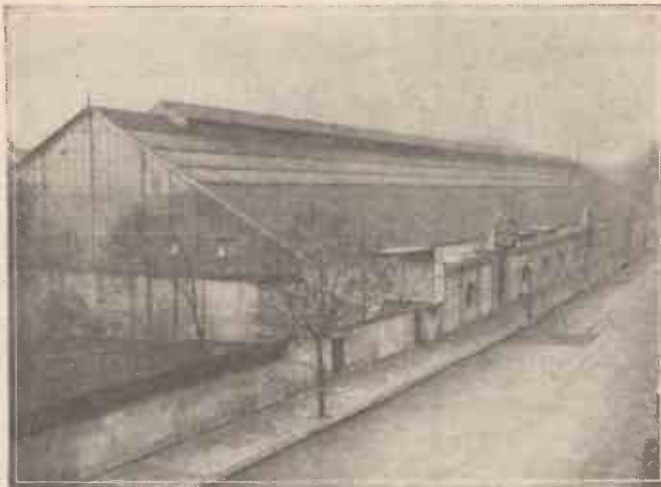

The B.B.C. and the trustees of the late Sir Howard Frank recently completed the contract for the sale of the Maida Vale Skating Rink, for use as studios.

Radio Parade

SHOULD you hear such a call, which, by the way, is rendered as *Par-ay-day*, log it as emanating from the new 5 kilowatt station near Lisbon (Portugal). It is operated by a local association of wireless enthusiasts who, too impatient to wait for the official 20 kilowatt station, have subscribed all the capital necessary for the construction of their own broadcaster. Previous to the "change-over" it was testing on 431 metres, but has now changed its wavelength to 291 metres, a channel it shares with Heilsberg (Germany).

A Daily Radio Serial

IMITATING an example set by most Continental papers, the Monte Ceneri studio now broadcasts every day between 12.20-12.30 G.M.T. a ten-minute's reading of a thrilling serial in the Italian language; it is destined in particular to the women folk, but the men also will listen to it during the luncheon hour. It was specially written for the microphone, and so far has not been published. It must be very awkward if the listeners miss an instalment, as they cannot buy a back number!

Czech versus Magyar

HUNGARY, as a dissenter to the Lucerne plan, has not yet adopted all the channels allocated to her for use on January 15th, and complaints are being made by Czecho-Slovakia that the Kosice broadcasts are being jammed by Nyiregyhaza. The former works on 269.5 m. and the latter on 267 m., but it should be on 208.6 m. Moreover, Magyarovar and Pecs, as relays of the Budapest programmes, who were requested to operate on the same common wave, are broadcasting respectively on 227 and 204.8 m. Not all quiet on the Eastern front!

"Memories"

A PROGRAMME of "Memories" will be heard by Belfast listeners on February 17th. Among the items included are a selection of Tosti's songs, and the March, *Tipperary*, which probably occupies the proud position of having been, in its day, the best known tune in the world.

Programme of Opera Choruses

A PROGRAMME of choruses from operas will be heard by listeners to the Northern Ireland station on February 19th.

Good Fare for Midland Regional Listeners

THE Divertissement programme for Midland Regional listeners on February 17th, consists of three short plays; Ralph and Ken, a vocal duo with piano and guitar, and *Songs of the Sea*, by Geoffrey Dams, tenor. The first play is a Chinese scena,

surgeon and devil in the relay to National listeners of *The Devil Take Her*, from Sadler's Wells on February 23rd, is a frequent broadcaster. His experience has been more than usually varied. In Canada he was farmer, cowboy, book-keeper, real estate salesman, homesteader, railway constructor, waiter, coal-miner, hunter, trapper, and mining engineer. He never thought of becoming a singer until during the War, when he was convalescing at Hastings after having been wounded; he entered for the Hastings Musical Festival, and won the gold medal in 1917.

S-W. Station CR6AA

WE understand that the Manica Trading Co., who are agents for Eddystone receivers in Portuguese West Africa, have commenced transmissions from their short-wave broadcasting station CR6AA, at Lobito, on a frequency of 7,177 kc/s.

Brass Band Concert from Glasgow

ON February 19th the Knightswood Brass Band will give a concert from the Glasgow Studio. Knightswood Band is one of the oldest in Scotland and its history is interesting. It was founded by miners in the little village of Knightswood in 1877. The village was annexed by Glasgow in 1912, and in place of pits there is now the largest garden city in Scotland. Scheme residents are beginning to take an interest in the village and the band with good results, and under the leadership of Mr. James Ellis, principal trumpeter of the Scottish Orchestra, the progress made since 1931 is remarkable.

(Continued on page 1012)

SOLVE THIS!

PROBLEM No. 74

Tonkins made up an Orbit receiver, but instead of using the specified Metaplex chassis he made one from wood and covered the upper surface with a sheet of aluminium. All connections were correctly made, but when tested he found that every time he switched on the fuse blew. All components were tested, and found to be in order, and none of the wiring was shorting. What was causing the trouble? Three books will be awarded for the first three correct solutions opened. Address your attempts to The Editor, PRACTICAL WIRELESS, Geo. Newnes, Ltd., 8-11, Southampton Street, Strand, London, W.C.2. Envelopes should be marked Problem No. 74, and should be posted to reach here not later than February 19th.

Solution to Problem No. 73

By using aluminium paint Brown had not screened his separate stages. This material is useless as a screen, and therefore no alteration had in effect been made to Brown's receiver. He should have used metal or metallized wood.

The following three readers successfully solved Problem No. 72, and books have therefore been awarded to them:—

H. Dainton, 16, Elm Park, Stanmore, Middx.
E. H. Smith, "Kenilworth," 11, Woodfield Avenue, Gravesend, Kent.
H. Crocket, 42, Lindale Road, Liverpool, 7.

Adapting your set to the New Wavelengths

The Extension of the Two Wavebands Under the Lucerne Plan has Placed Several Popular Stations Outside the Wavelength Range of Many Receivers. This Article Explains a Number of Ways in Which This Difficulty can be Overcome

UNTIL recently there were practically no worth-while European high-power stations working on wavelengths outside the two ranges of approximately 220 to 550 metres and 1,000 to 2,000 metres. This state of affairs has, however, been considerably modified with the coming into force, on January 15th of this year, of the *Plan de Lucerne*. There is no doubt that the Lucerne Plan has already proved to be a very great success, and it has certainly made the interference-free reception of a greater number of stations a much simpler matter than it was before. It has introduced one rather serious difficulty, though, since the wavelength ranges, in which are included a large number of the popular stations, have been rather considerably widened. As a matter of fact, a receiver to bring in all the better-known British and Continental transmitters must now cover the wavelength ranges of from at least 200 to 600 metres, and from about 740 to 2,000 metres.

There are actually very few sets which will adequately cover such wide ranges without modification, and there are probably no more than half a dozen makes of commercial receivers—much less home-constructed ones—which will tune below 220 metres, and at the same time, above 500 metres. In the same way, few sets can be tuned to less than 900 metres or so on the long-wave band. The owner of a factory-produced receiver can do very little to increase the wavelength range of his set, but there are many ways in which the home-constructor can modify his, so that the tuning range may embrace the wavelengths now in force.

Minimum to Maximum Capacity-Ratio

There are only two components which can have any appreciable effect upon the tuning range, and these are the coils and variable condensers. Any alteration must, therefore, be concerned with these. Generally speaking, the factor which has most bearing upon the range of wavelengths (or, more correctly, the range of frequencies), which can be covered by a particular receiver is the ratio between the maximum and minimum capacities of the tuning circuits. The greatest portion of the capacity is that of the variable condenser used for tuning purposes, so this should receive consideration first. A so-called .0005 mfd. tuning condenser might, when used in conjunction with a given coil, cover a range of, say, 300 to 550 metres, or from 230 to 550 metres—it all depends upon the minimum

By FRANK PRESTON

capacity. This point will more readily be appreciated when it is mentioned that, although a number of good .0005 mfd. (maximum) condensers have a minimum capacity of no more than 30 micro-microfarads, or .00003 mfd., there is a number of apparently similar components whose minimum capacity is as high as .000075 mfd. The difference between the "coverages" of the two components taken as examples will be appreciated when

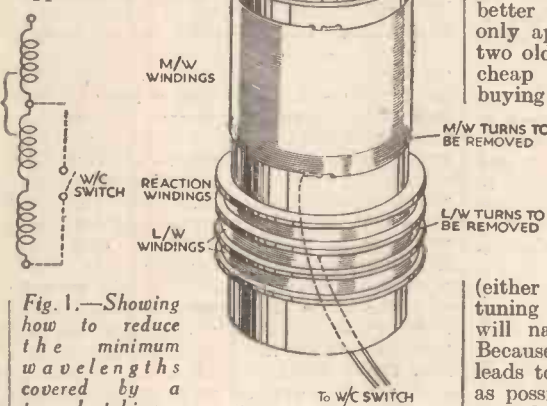

Fig. 1.—Showing how to reduce the minimum wavelengths covered by a tuner by taking a few turns from the medium and long-wave windings.

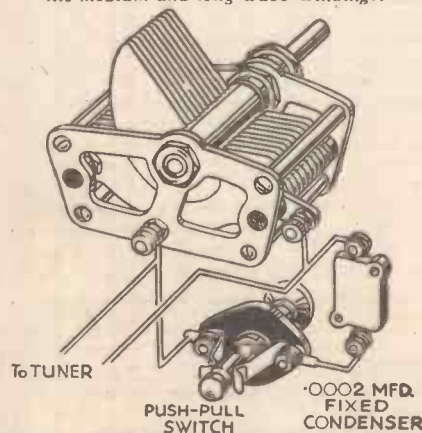

Fig. 2.—The tuning range can be extended by arranging to switch a fixed condenser in parallel with that used for tuning.

it is seen that the ratio between maximum and minimum capacity in the former case is 50:3, or about 17:1; in the latter case, the ratio is only about 7:1. It need not be stressed that the condenser with the higher minimum capacity would cover a considerably narrower wavelength range than would that with the low minimum.

The point of capacity-ratio is mentioned to show that the particular tuning condenser employed can have a tremendous effect upon the tuning range of any kind of receiver. In many cases where the wavelength range is now too restricted, a distinct improvement can be effected by the simple process of fitting a new and better tuning condenser. Of course, this only applies to sets which are a year or two old, or which have been built around cheap and inefficient components. In buying a new condenser it is wise to insist upon being told what is its capacity-ratio; do not purchase the component unless the ratio is less than 15:1.

It will be appreciated that the self-capacity of the tuning coil and associated wiring will always be added to the capacity (either maximum or minimum) of the tuning condenser, and if this is large, it will naturally reduce the capacity-ratio. Because of this it is important that the leads to the coil should be kept as short as possible, and that they should be well spaced.

Aerial Capacity

Another point to consider is the capacity effect of the aerial upon the first tuned circuit; if this is fairly high, the tuning range will be restricted unnecessarily. It is rather fortunate that most of the methods of increasing the selectivity of a coil also tend to reduce the aerial capacity, and, therefore, anything which is done to increase the range will also effect an improvement in selectivity, and *vice versa*. The very old dodge of connecting a pre-set condenser in series with the aerial often serves to extend the tuning band to a marked extent, and the lower the capacity of this condenser, the wider is the range. Other selectivity ideas, such as were dealt with in the *PRACTICAL WIRELESS* free booklet "Making Your Set Selective," presented with the issue dated January 20, are also worthy of trial from the viewpoint of increasing the wavelength "coverage."

(Continued overleaf)

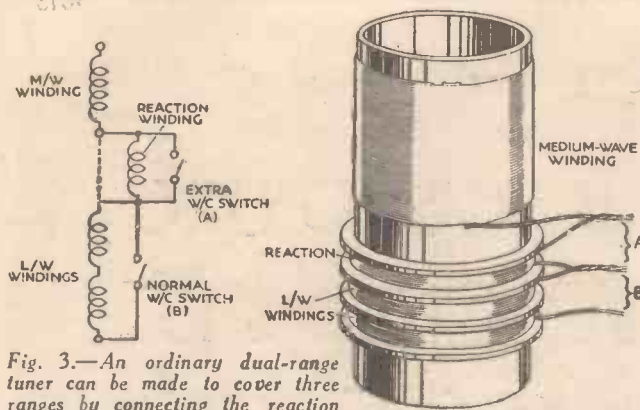

Fig. 3.—An ordinary dual-range tuner can be made to cover three ranges by connecting the reaction winding in series with the other two and fitting an extra w/c switch. It is important that the three windings should be wound in the same direction; if not, the connections to the "reaction" one should be reversed.

(Continued from previous page)

Modifying the Coils

There are many tuning coils on the market, and in use, which could not possibly be made to tune down to 200 and 750 metres, respectively, on the two ranges by any other means than by altering the windings themselves. Therefore, if it is found that the necessary tuning ranges for the new wavelengths cannot be obtained by attending to the points which have already been mentioned, it will be best to remove a few turns of wire from both windings of the tuners in use. This should only be attempted in the case of tuners of fairly simple type in which the windings are placed on an ebonite, bakelite, or similar former, since there would be far too much risk of causing damage if any alteration of this nature were attempted with iron-core coils, or with any others which have been accurately matched and balanced to operate in conjunction with a multi-gang condenser. Incidentally, however, it will rarely be found that the newer types of coils will fail to tune down to slightly over 200 metres and about 900 metres, and so they will cover most of the wavelengths in use.

Removing Turns

Fig. 1 indicates the most satisfactory way of removing turns from a tuner of the type first referred to, and it will be seen that they are taken from the "end" of the medium-wave winding, and from the "beginning" of the long-wave one. If the component is a factory-produced one, and the exact constructional details are

not known, it will be found best to start by locating the terminal which is normally joined to one side of the wave-change switch. There will be two leads from the windings to this terminal, and they can be traced back to the windings on the inside of the former. First disconnect the leads from the terminal, follow one of them back to the windings, pull the wire through the hole in the former and proceed to unwind the requisite number of turns. In most cases, it will be found that

about eight turns require to be taken from the medium-wave winding, and some twenty-five from the long-wave section. The exact numbers naturally depend upon the diameter of the former and the lowest wavelength to which the coil previously tuned. To be on the safe side, therefore, it is best to start by removing only four or five turns. The minimum wavelength can then be checked, and more turns taken off if necessary. When the required minimum wavelengths have been obtained, the ends of the windings can be anchored just as they were before, and the leads re-connected to the appropriate terminal.

In nearly every case the reduction which has been effected in regard to the *minimum* wavelength will also occur in respect to the *maximum*. In other words, if the tuner previously covered the range from 250 to 550 metres and the alteration has enabled it to tune down to 200 metres, the highest wavelength to which it will tune will be somewhere about 500 metres. Precisely the same thing will also occur on the long-wave range. Generally, this will not be very important, but if it means that some station which is particularly wanted is excluded from the tuning range, another slight alteration will be desirable. This will consist of arranging a fixed condenser of about .0002 mfd. which can be connected in parallel with the variable tuning condenser. Fig. 2 shows the simplest arrangement of this, where it can be seen that the fixed condenser is brought into circuit by means of a push-pull switch. When the switch knob is pushed in the tuning condenser operates normally, but when it is pulled

out the two condensers are in parallel and the higher wavelengths can be reached. This is not an ideal system, because the efficiency of any tuned circuit becomes less when the capacity is increased beyond certain limits. Nevertheless, the increase from .0005 to .0007 mfd. maximum is not very great, so that the losses incurred will be fairly slight.

It would be much better if the tuner could be arranged with slightly different windings, tapped in more positions, for then it would

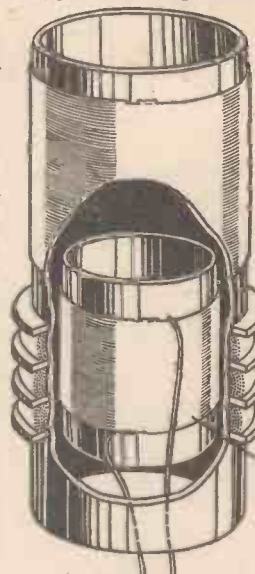

be possible to choose the correct number of turns to tune to any required wavelength in conjunction with the normal tuning condenser. One simple, though often effective, way of achieving this object with any ordinary tuner is to modify it so that the winding normally

80 TURNS 30 SW.G. ENAMELLED WIRE ON CARDBOARD TUBE FITTING INSIDE COIL FORMER

Fig. 4.—After modifying a tuner as shown in Fig. 3 it might be necessary to fit a new reaction winding as indicated above.

used for reaction can be wired in series with the other two. The general idea is shown in Fig. 3, where it will be seen that the wires from the "end" of the medium-wave winding and the "beginning" of the long-wave one (which were previously joined together and taken to the "switch" terminal) are connected to the two ends of the reaction winding. The long-wave winding is short-circuited when desired by means of the ordinary wave-change switch, a second switch being used to short-circuit the "reaction" winding which is now used for tuning. When using this arrangement a few turns should be removed from the medium-wave coil, and about seventy turns should be taken from the long-wave winding.

A tuner modified in this way could easily be made to tune from about 150 to 2,000 metres with little or no break. When both switch-knobs are pushed in the range is from about 900 to 2,000 metres, when switch A is pulled out the range would be from about 450 to 900 metres, and when both switches are pulled out, a range of from somewhere about 150 to 450 metres would be obtained.

An alteration such as that described would, of course, make the reaction winding useless for its normal purpose, and so it would be necessary in many cases to arrange another one. This could most conveniently take the form of a winding of about eighty turns on a short cardboard tube made to fit fairly tightly inside the coil former. The arrangement is illustrated in Fig. 4 and it will generally be found best to place the coil so that it is rather nearer to the long-wave than to the medium-wave section. In any case it can be moved about slightly until a position is found at which reasonably uniform reaction control can be obtained.

ROUND THE WORLD OF WIRELESS

(Continued from page 1010)

A Novel Broadcast

AN ambitious broadcast to be undertaken by the Midland Region is a tour of the Rugby wireless station of the G.P.O. on February 17th. The programme, which will be relayed to London Regional listeners, will include a visit by microphone to the top of one of the 820-foot masts, where an engineer will speak to listeners and describe the scene from this elevated position.

Revival of "The Arcadians"

"THE Arcadians" is to be revived on February 27th and 28th. This play was first produced at the Shaftesbury in 1909, where it had a record run and incidentally made the reputations of the late Alfred Lester and Florence Smithson, whose interpretation of Sombra was a

musical comedy classic. The lyrics were in Arthur Wimperis' best vein, and the score by Lionel Monckton and Howard Talbot is still played frequently all over the country. It was broadcast three times some seven years ago, produced first by Howard Rose, and Gordon McConnel, who played the part of Bobby in 1913 himself, repeated it twice in 1927. In those days two hours was allowed for the broadcast. This revival will last an hour and a quarter.

Popular Band Music from the North Regional FODEN'S Motor Works Band, last year's Champions in the Crystal Palace Contest, will broadcast on the North Regional wavelength on February 17th. Conducted by F. Mortimer, the band will play two groups of popular music and the programme will also include songs by Douglas Kirke (bass).

Can Receiver Design Be Improved?

In This Article the Author Discusses the Change Which Has Taken Place in Wireless Set Design and Visualizes Some Future Tendencies.
By W. J. DELANEY

WHEN the modern commercial receiver is examined it will be found that during the past twelve months very little change has been introduced in the method of building up the actual receiver portion. It would, in fact, appear that the wireless receiver of to-day has become stabilized, and that we are not to depart from the metal chassis in the form of an inverted tray; valves standing upright on the upper surface; the tuning condenser occupying a principal position on this chassis, and a control knob on the front, which, in addition to operating the movable portion of the condenser, also moves a scale or pointer travelling over a scale to give some indication of the actual tuning point of the receiver. It is interesting, however, to speculate whether the wireless receiver must always remain so. The average receiver of to-day has, say, three controls on the front of the cabinet, a silk-backed grille to cover the loud-speaker mouth, and a cabinet of rectangular shape of just sufficient size to accommodate the receiver and speaker. Can this be improved upon?

How Design Has Changed

Fig. 1 is an illustration of one of the early types of valve receiver. Why was the cabinet shaped like a desk? There was ample room inside for the components, and there was, in fact, a tremendous amount of "spare" room. Presumably the designers of the day thought that the sloping desk offered a more convenient method of accommodating the control knobs so that the various adjustments could easily be made. The valves of that time had to be vertically arranged in view of the risk of the filament sagging and touching the grid. Who would be prepared to house an instrument of this type in the modern

drawing-room? The change in design has been brought about both on account of the demand for a less scientific-looking piece of apparatus, and as a result of the improvement in the design of component parts. In Fig. 2 is shown a fixed condenser of 1920, and on its right, on the same scale, is a modern component of the same capacity. Obviously this latter component will take up much less space, and may, in addition, dispense with two connecting wires and two

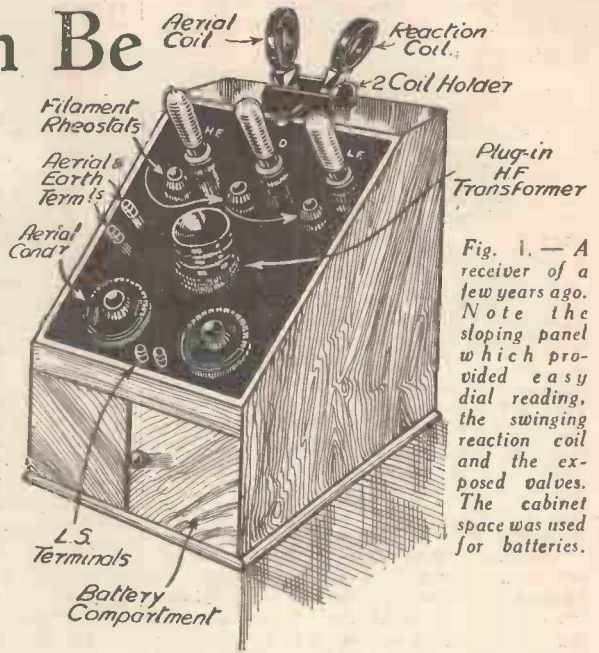

Fig. 1.—A receiver of a few years ago. Note the sloping panel which provided easy dial reading, the swinging reaction coil and the exposed valves. The cabinet space was used for batteries.



Fig. 2.—A condenser of a few years ago and a similar capacity of the present day. The remarkable saving in space may be gauged from the fact that the two components are drawn to the same scale, and have identical characteristics.

terminals, thus effecting a reduction in cost and weight. The modern valve, also, is smaller, and the method of suspending the filament on springs enables the valve to be mounted at any angle without risk of electrode short circuits taking place. Suppose we try and improve on the present method of making up a receiver. How can we make the set appear more "homely" and easier to operate?

Control Improvements

Dealing first with the controls: is the tuning scale and moving pointer (or fixed pointer and moving scale) all that can be desired in an instrument which is designed primarily for the provision of home entertainment? At present it is necessary to adjust a variable condenser in order to select the required broadcasting station, and with the permeability method of tuning a movement has to be imparted to the iron core (or the coil in relation to the core) in order to vary the resonance point. Either of these methods necessitates a rotary movement to the main operating control, and in practically every radio receiver this main control consists of a small knob less than two inches in diameter which has to be completely rotated perhaps a dozen times to pass through the complete tuning range. This is by no means an ideal arrangement. Some time ago I designed a two-valve receiver in which tuning was effected by condensers of the pre-set type, instead of the standard variable condenser, and these were individually tuned to the principal stations and operated by push-pull switches. Thus, to receive a given station it was only necessary to push or pull the appropriate switch, and there was the station at its best. Surely a more popular idea would be to provide a row of very neat push buttons, preferably on a small sloping inlaid panel, each of which operated on a similar principle to that just mentioned, and so arranged that if any one button was pressed it would automatically return any other button to its original position. A similar arrangement is obtainable for aeroplane dashboard illumination, although for the radio requirement not more than a quarter of an inch movement should be necessary. The commercial receiver can be standardized so that fixed condensers of the correct capacity could be made to tune to the principal wavelengths, with provision for slight trimming to compensate for any slight discrepancies. So much for the tuning. Very few modern receivers incorporate an automatic on-off switch. Where such a device is incorporated it is usually ganged up with a control which

(Continued overleaf)

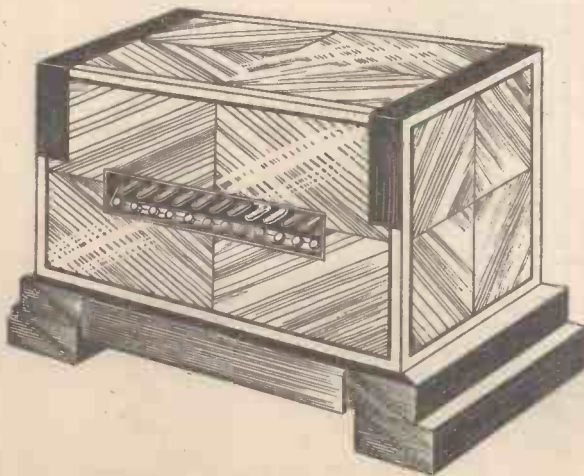

Fig. 3.—The receiver of the future? No loudspeaker opening; no multiplicity of controls; a simple row of press buttons for station selection.

(Continued from previous page)

necessitates a readjustment every time the set is switched on and off. For instance, the potentiometer which controls the variable-mu valves in battery receivers is sometimes fitted with an on-off switch, so that when turned to the weakest signal position the set is switched off. This means that every time the set is switched on the user has to rotate the control to the best position, and this usually varies according to the type of musical item being received. Generally, during the course of one evening's listening a point is found where best "all-round" results are obtained, but when listening is finished this setting has to be lost as the control has to be operated to turn the set off. Similarly, the switch is sometimes fitted to the wave-change control and the same drawbacks are apparent here. Why use a wave-change switch? The press-button idea suggested above could remove both of these switches, as the buttons intended for the long-wave stations could automatically operate the extra loading coil or other arrangement used for the higher-wave stations. One button could be arranged so that it would switch the set off, although no doubt a method of coupling the push buttons could be devised where the operation of one button at any part of the panel would bring the set into operation and a separate button would automatically switch off and return all buttons to normal.

The Volume Control

The arrangement I have described has disposed of three controls—the wave-change switch, the on-off switch, and the tuning knob. The other controls usually fitted to a wireless set are the reaction and the volume controls. With a modern receiver employing two H.F. stages reaction is totally unnecessary, and this disposes of that control. Volume does require some slight adjustment according to the item

being received, but with automatic volume control devices it should be quite possible to arrange that the output valve delivers a constant volume, with a small pre-set adjustment arranged so that the user could set this to deliver the strength which he finds most suitable for general use. Strictly speaking it should not really be necessary to turn the volume up and down for each item, as each listener should choose his items and only listen to those which he likes, and these will obviously be required at normal strength. If an item is transmitted which you do not like you should (theoretically) switch off, although to avoid the

is arranged as part of the "furniture," and this could be of thin, specially-selected wood grained or quartered to match the rest of the cabinet work. It could have a speech coil attached to its centre and it would take the place of the usual cone. A flat diaphragm has successfully been employed and gives very good results. Thus, I have shown that it should be possible to have a receiver consisting of a cabinet only, with no fretted openings or other old-fashioned arrangements, and with a neat row of buttons for programme selection. What of the arrangement of the actual receiver? By dispensing with the variable-ganged con-

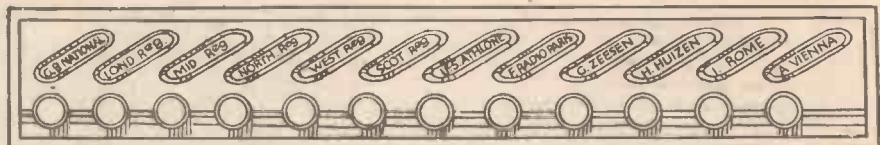

Fig. 4.—The tuning panel of the future? The buttons operate in such a manner that when one is pressed it automatically returns any other button to its out-of-circuit position.

trouble of waiting for heaters to get hot, etc., a "muter" button could be fitted to reduce signals to inaudibility or at least to almost imperceptibility.

The Loud-speaker

The piano of our parents' day had a beautifully fretted front, behind which was arranged a length of pleated silk. It looked very ornate and was a splendid resting place for dust and insects. A modern home would be disgraced by such a scheme, yet practically every set maker employs a similar idea. There are exceptions, but I am generalizing at the moment. With the improvement in speaker design, why cannot the cabinet itself be used as the speaker? I would suggest a neat cabinet, where a plain panel, say about 12ins. square,

denser much room would be saved, and by arranging the valves in a horizontal position, great compactness could be obtained. The L.F. transformer has been decreased to very small dimensions owing to the employment of the nickel-iron and similar cores, whilst the tuning coils have been similarly reduced in size. The average mains transformer, however, is still too bulky to permit of real compactness.

I hope the above remarks will lead some manufacturer to turn his endeavours towards a much more "practical" type of wireless receiver, and all keen experimenters should turn their efforts in the same direction. It would also be interesting to know what our readers think of these suggestions, and whether or not they are in agreement with me.

THERE are a number of readers who would like to take advantage of the new variable-mu H.F. valves, and who already possess a receiver which is fitted with an H.F. stage employing the ordinary type of screen-grid valve. The actual alteration which is required to enable this to be carried out is extremely simple, although it may vary slightly with different types of receivers. Two simple methods are illustrated below, that on the left being most suitable for the type of receiver which employs a simple tuned circuit for the H.F. stage, and that on the right being the method which should be adopted for receivers which employ a band-pass tuning circuit or any other more intricate tuning arrangement. As may be seen from the illustrations, one wire only has to be removed in each case. With most circuits it will only be necessary

REPLACING AN S.G. WITH A VAR.-MU.

to cut through the wire which is indicated by a broken line, and then the ends of the wire may be bent back so that they do not produce a short circuit by coming into contact with some other bared point. In the left-hand scheme, the wire which is removed is that which joins the tuning coil to the common earth line, and when it has been removed the end of the tuning coil is connected direct to the arm of a potentiometer, which may be mounted on the panel in a convenient position. One end of this control is joined to the earth line and the other is fitted with a flexible lead to be plugged

into a grid-bias battery. The value of the battery may be 9 or 18 volts, according to the type of valve which it is proposed to use. The positive side of this battery is joined to the earth

line. It will be necessary to prevent the battery discharging itself through the potentiometer. A three-point switch may be used in place of the present on-off switch to avoid this trouble.

In the second method the grid connection is severed, and the ends of the wire are joined to the two terminals of a fixed condenser, the value being .001 or thereabouts. It is not critical. From the grid, a connection is made to the arm of the potentiometer above-mentioned, only this time a high resistance, 1 or 2 megohms, is inserted in the lead, and the biasing battery is connected as in the former case.

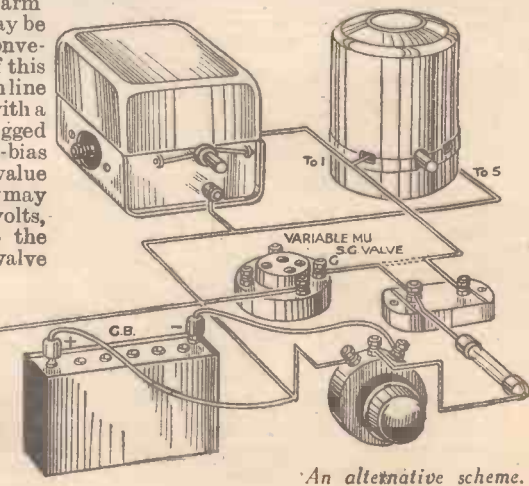
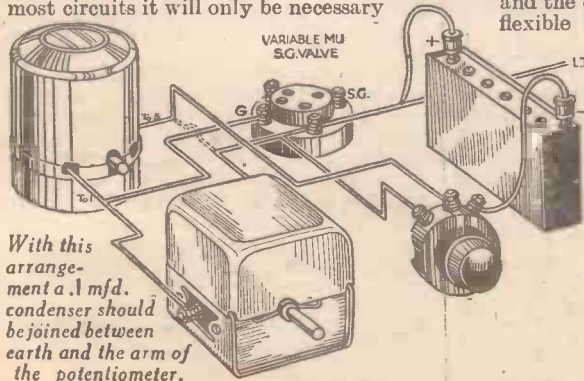

An alternative scheme.

Making MULTI-PURPOSE SWITCHES.

By E. L. PARKER

Full Constructional Details of a Neat Switch Having a Variety of Applications:

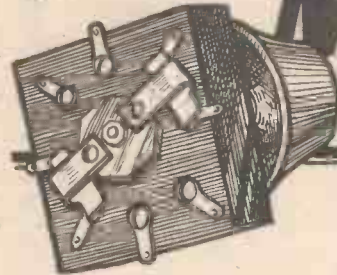

AN excellent multi-purpose switch can be made from scrap materials which are generally to be found in the experimenter's junk box.

The first requirement is an ebonite base, cut from an old panel either $\frac{1}{8}$ in. or $\frac{1}{4}$ in. thick. This is cut and drilled to the dimensions given in Fig. 1. The slot is left until afterwards, as its exact position and length cannot yet be decided. The centre hole is to take a bush. This bush, and perhaps the spindle, can be found in an old rheostat or a similar component. It should be about $\frac{1}{4}$ in. long and be complete with nuts, as it is intended to make the switch a one-hole fixing component. It will be seen that the spindle which fits this bush is provided with a collar (see Fig. 2). This is essential as it forms an anchorage for the spring arms, and, if a suitable spindle is not available, a piece of threaded rod can be used, a nut being soldered in a suitable position. Alternatively, the spindle could be drilled and a pin fitted. Whichever method is employed make sure that the dimensions of the collar, or its equivalent nut or pin, are sufficiently small to allow of the nut being fitted on the bush.

The six holes should be tapped to suit the thread of the studs, which consist of 6B.A. round-headed brass screws. Failing an available tap the holes may be drilled $\frac{3}{32}$ in. diameter, and the thread cut with the screws themselves. The screws should be fitted with soldering tags, and it is wise to make sure that these do not project on the reverse side, because if the switch should be fitted to a metal panel it would most likely short all the contacts. The screw heads should then be filed until a certain amount of "flat" is shown; this makes the movement better and the contact more sure.

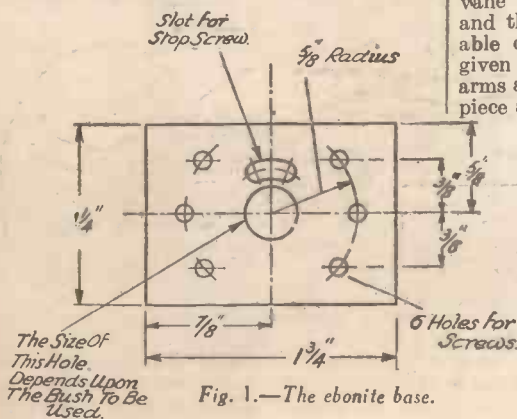

Fig. 1.—The ebonite base.

A small piece of $\frac{1}{4}$ in. ebonite is next required to make up the centre block illustrated in Fig. 3. The holes for fixing the spring arms and the stop screw should be $\frac{3}{32}$ in. from the edge, as shown. The

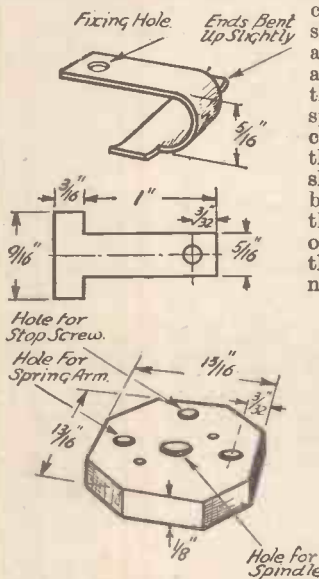

Fig. 3.—The ebonite centre-block with all dimensions, and the spring arms.

centre hole should be of a size suitable to take the chosen spindle. Incidentally, the spindle should not be larger than 4 B.A., otherwise the nut will not clear the spring arms. This centre hole can be plain, the ebonite block being held by a nut on either side, or it can be tapped, only one lock-nut being required under these circumstances. The two further holes shown should be left for the time being.

The Contact Arms

Two spring arms are required, and they are cut from thin springy brass, copper, or phosphor bronze. An old brass condenser vane will provide the material for these, and they can be cut with scissors if reasonable care is taken. The dimensions are given in Fig. 3, which also shows how the arms are to be bent. The ends of the "T" piece are to be bent up slightly, the reason for this being explained later. The arms should then temporarily be fitted to the centre block, and the position of one corner of each of the spring arms marked on the ebonite. Next remove the arms and drill $\frac{1}{8}$ in. holes at the two marked positions.

One corner of each of the arms will now be directly over the newly-drilled holes. These corners should be pressed down at right angles to the arm into the holes. This makes a firm anchorage for

the arms, and prevents them turning except with the centre block.

The switch can now be partly assembled, and should appear similar to the one illustrated in Fig. 2. See that the arms "sit" between the contact screws and require a definite start when moving to the other position: the arms should then slide over the screws and sink into the recess between the centre and the other outside screws. This "sitting" between the screws is only very slight, but is quite sufficient for the purpose, the curved parts of the arms ensuring a good movement.

At this juncture one point should be attended to. Turn the switch until the arms are resting on the centre screws only; then examine the switch carefully, and make sure that the arms are not touching either of the outside screws. If one or both of the arms touches both the corresponding outside screws together, the "T" parts should be bent up a little more until the screws are cleared. The object of this is to prevent the two outside screws being connected together by the spring arms. A slight movement of the arm either way will naturally make it touch one of these screws.

The Finishing Touches

At the moment the spindle can be turned completely round, so a stop screw must be fitted. The contact arms should be placed in one of the two positions, and a scriber or any sharp pointed instrument inserted through the hole in the ebonite centre block. The ebonite base should be marked, and then, with the switch in the other position, it is again marked. The switch is dismantled and holes drilled of a diameter to suit the stop screw (probably 6B.A.), these holes then being filed into a slot. The resulting aperture should then be similar to that shown in the ebonite base shown at Fig. 1. A screw about $\frac{1}{4}$ in. long is then inserted in the ebonite centre block, and held in position either with a lock-nut or by threading the ebonite

(Continued overleaf)

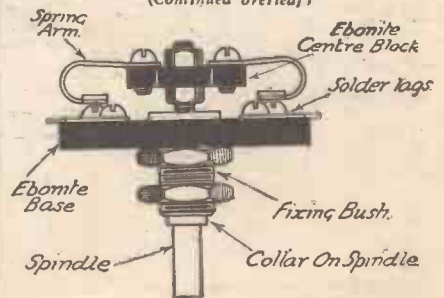

Fig. 2.—Side view of the assembly.

(Continued from previous page)

block. The switch can be finally reassembled, the end of the stop screw sliding in the newly-made slot.

In the form described, the switch acts as a double-pole change-over switch, and it can be wired as such, the two centre screws acting as the centre poles, and the four outside screws the other contacts. Before using the switch, make sure that the nut securing the ebonite centre block to the spindle is not shorting the two spring arms. It should not do so, but if there is any possibility of this, the best cure is to remove the nut and fit a washer of some insulating material, the nut being then replaced and finally tightened.

A Switch for "Practical Wireless" Screened Coils

Although only one particular type of switch has been dealt with, it is obviously quite possible to build practically any type by the exercise of a little ingenuity. The writer recently made up two of the coils described in PRACTICAL WIRELESS, December 9th, 1933, issue, and wished to make a switch for long and short waves. Having no suitable switches handy, it was decided to make one on the lines suggested above and this is illustrated in Fig. 4.

This is very similar to the other switch, the main differences being two extra terminal screws, a slightly wider base, and a different slot for the stop screw. The base is increased in width to 1 1/2 in. to allow room for the extra terminal screws, and a piece of flex is joined to

each of these. These pieces of flex go underneath the ebonite centre block and are then brought up in loops over the block, being joined to the two arms, either by clamping under the holding screws, or soldered to two taps. Fig. 4 will make this quite clear. If preferred, the two "blank" studs could be employed as terminal points, but it is best

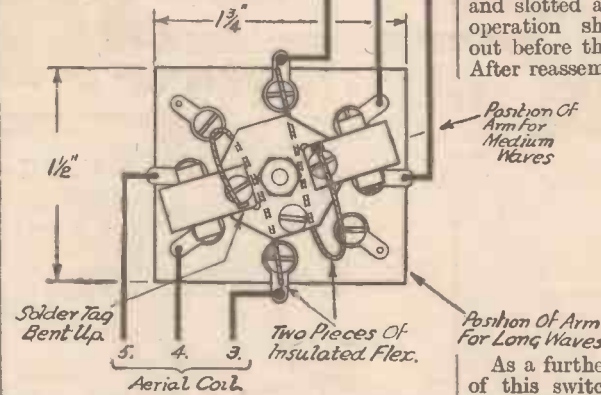

Fig. 4.—How to construct a switch suitable for use with the coils recently described in PRACTICAL WIRELESS.

to leave them unused, as they might be of some use later on.

For use in conjunction with two of the PRACTICAL WIRELESS coils in the type of circuit illustrated on page 683, of the issue dated December 16th, the stop screw will

also have to be specially arranged. Place the arm in the position shown for medium-waves in Fig. 4, and mark one drilling position through the stop screw hole in the manner already described. The spindle should then be turned until the arms are central over the other two outside studs; this is the long-wave position, and is also shown in Fig. 4. The base is again marked, and, after dismantling the switch, is drilled and slotted as in the previous case. This operation should preferably be carried out before the flex wires are soldered on. After reassembling it should be found that

in one extreme position the arms "sit" between the contact screws, but in the other extreme position they rest on the two outside screws. This is, of course, the long-wave position. For the sake of clarity the connections for the two coils referred to are also shown in Fig. 4.

Another Application

As a further example of the adaptability of this switch, by rearranging the stop and narrowing the "T" part of the arms the component can be used as a two-pole three-position switch, and in such form would probably find a variety of uses in a modern set. In this case, as there would be three positions of the arms, it would be necessary to fit a knob with a pointer to indicate these positions. Such knobs may be purchased quite cheaply, if they are not available from an old component.

MANY listeners desire to use a balanced armature speaker as an extension for occasional use in a room removed from that in which the set is placed. If class B output is employed, the extension speaker will give poor results and also reduce the output from the moving-coil speaker, normally used, to a fraction of the full, rich reproduction previously enjoyed. The reason for this is that the efficiency of a class B output system is far more dependent upon proper output matching than is the case with an ordinary power or pentode valve. For this reason a balanced armature speaker can never entirely fulfil the requirements of a class B valve.

A moving-coil loud-speaker does not vary in impedance with different frequencies to any great extent; a well-designed model that is nominally 8,000 ohms may

ADDING A BALANCED ARMATURE LOUD-SPEAKER TO CLASS B.

It is explained below how a Balanced Armature Speaker can be used with Class B without sacrificing quality of reproduction. By PERCY RAY.

vary from 7,000 to 9,000 ohms. On the other hand, a balanced armature (moving-iron type of good make) might be 120 ohms at 100 cycles, 3,000 ohms at 1,000 cycles, and 2,500,000 ohms at 8,000 cycles. These figures represent an extreme case, but they do exist.

Again bearing in mind that a class B valve requires a constant load, it is very evident that something must be done to increase the average impedance, so that it is somewhat greater than that of the moving-coil speaker that it will be connected across.

Overcoming the disadvantages of the Moving-iron Speaker

The circuit diagrams below show the theoretical arrangements of a system to overcome the inherent disadvantages of moving-iron speakers. The cure is not 100 per cent., but the general quality from both speakers is raised to an acceptable level. A condenser is

connected across the speaker to cut down the impedance of the windings to the top notes; this condenser makes little or no difference to the middle frequencies, and a quite negligible difference to the low frequencies. In this manner the impedance is levelled out, although the impedance to the very low frequencies is not raised, and there is a limit to the bass expected from this type of speaker.

A resistance is inserted to minimize the effect of the condenser on the moving-coil speaker, and to raise the total impedance in parallel with it. The resistance may be variable or fixed, but the former is preferable as the value is more or less unknown. It should be adjusted so that it is as high as possible consistent with good volume on the extension speaker, and the value of the resistance, if variable, can

conveniently be equal to the impedance of the moving-coil loud-speaker transformer primary, or a little less.

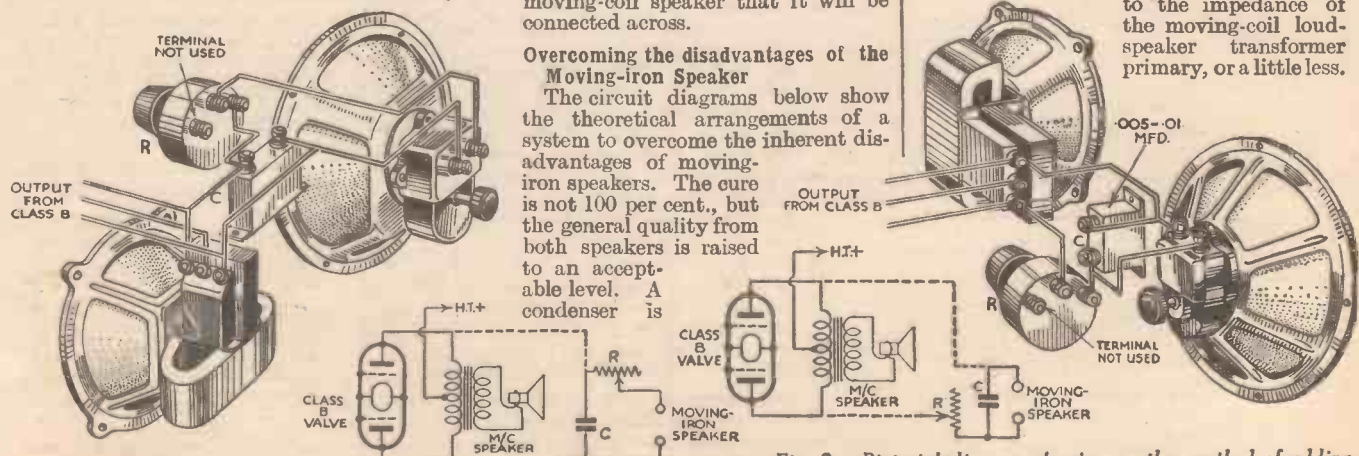

Fig. 1.—Showing one method of compensating a moving-iron loud-speaker to work in parallel with a moving-coil loud-speaker from Class B.

Fig. 2.—Pictorial diagram showing another method of adding moving-iron speaker. The value of R should be about equal to the primary impedance of the M/C loud-speaker transformer.



Not just a pentode — a **Screened Pentode**

... and not just a Screened Pentode, a Mullard Screened Pentode. Have you a Pentode in your set—in the L.F. stage? Yes!—and do you remember the difference it made to your output when Mullard Scientists first introduced this type of valve to the ordinary listener? Well—now Mullards, after extensive research, have come to give you a high-class Pentode valve specially constructed for the aerial (H.F.) stage of A.C. receivers. It is a wonderful achievement. More Power in the early stages—Pentode Power in the H.F. stage! Ask your dealer about this up-to-the-minute valve. And remember—the Screened Pentode is made by Mullards—which speaks volumes.



Whenever you want advice about your set or about your valves—ask T.S.D.—Mullard Technical Service Department—always at your service. You're under no obligation whatsoever. We help ourselves by helping you. When writing, whether your problem is big or small, give every detail, and address your envelope to T.S.D., Rel. D.S.D.

S.P.4
V.P.4
1716 **Mullard**
THE · MASTER · VALVE

The Mullard Wireless Service Co., Ltd., Mullard House, Charing Cross Road, London, W.C.2.

Ark.

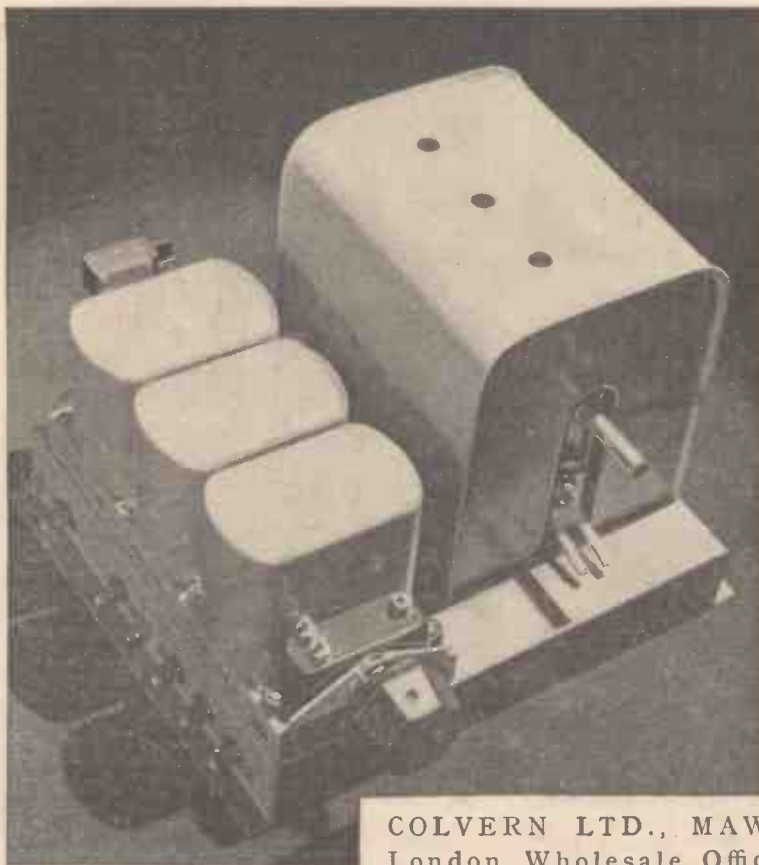

Most efficient tuning unit of all!

- The ideal tuning unit for Amateur and Expert Constructors alike. Saves endless time, trouble and money.
- Built of the finest components only, carefully tested and perfectly matched.
- As it incorporates Ferrocart coils, the most advanced coils yet made, the highest degree of selectivity and sensitivity is ensured.
- Make certain of the best results—get a Colpak for your next set. The type illustrated is "Colpak" Type H. at 57'6

COLVERN

Colpak-Ferrocart Tuning Unit

COLVERN LTD., MAWNEYS ROAD, ROMFORD, ESSEX
London Wholesale Office: 150, King's Cross Road, W.C.1

Made under licence from the patentee, Hans Vogt.

An Invaluable Handbook

TWENTY-FIVE TESTED WIRELESS CIRCUITS

All the sets described have been designed to meet modern needs. They range from simple crystal receivers to a seven-valve super-heterodyne, and all the sets have been made and tested before inclusion.

This is one of

Newnes' HOME MECHANIC Books

Ask your Newsagent to show you other Titles in This Helpful Series

Obtainable at all Booksellers, or by post 1/2 each
from George Newnes, Ltd., 8-11, Southampton
Street, Strand, London, W.C.2.

1/-
EACH

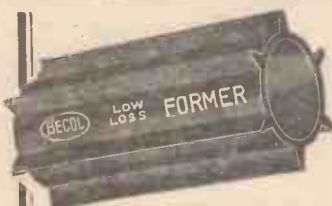

Read this

QUALITY Produces EFFICIENCY

TESTED BEFORE DESPATCH

The original BECOL ebomite low loss formers are thoroughly reliable. They are used in all parts of the world. Look for the BECOL trade mark. Ask your dealer. If unable to supply write direct. SEND NOW, enclosing 6d. (post free) for third edition up-to-date handbook of tuning coils for DUAL RANGE, BAND-PASS, and SUPER-HET. circuits. Fully illustrated with data. A very interesting handbook.

RODS, SHEET, TUBES, PANELS

The BRITISH EBONITE Co., Ltd.,
Hanwell, London, W.7.

Nº 2 NOW ON SALE



THE
GREAT NEW
WEEKLY
FULL OF
THRILLING
STORIES
OF THE
WORLD
TO BE—
MASTERPIECES
OF
IMAGINATION!

You will enjoy in
this week's issue—

SPACE!

A breathless story by a
man of science—none
other than famous
Professor A. M. Low.

Many other thrilling
stories you will find in
"SCOOPS"—the paper
that gives you up-to-date
fiction!

Nº 2

SCOOPS

NOW ON
SALE 2D

OPERATING THE **A.C. FURY 4 SUPER**

The Simple Preliminary Adjustments are Here Described and a Test Report of the Receiver is Given.

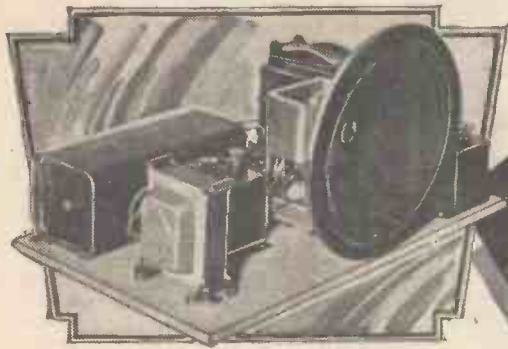

It will be noticed that on page 979 of last week's issue a radiogram cabinet was illustrated for the A.C. version of the Fury Four, whilst on page 980 the mains portion of this receiver was shown in a small cabinet. The reason for showing two separate editions of this receiver is that many readers will prefer to assemble the apparatus as a complete radiogram, whilst others will wish to use an ordinary gramophone fitted with a pick-up when reproducing records. The battery "version" of the "Fury Four" was housed in the two-piece cabinet which contained the actual receiver in the lower section and the speaker in the upper. In order to maintain consistency in the complete range, it is necessary to place the mains receiver in the lower portion of the same type of cabinet, and to build the mains section on the baseboard which carries the loud-speaker, and to place this in the upper portion of the cabinet. At my special request, however, Messrs. Peto Scott designed a radiogram cabinet which, in addition to the usual gramophone motor fittings, etc., would be capable of carrying the records. As may be seen from the illustration herewith, they have produced a most attractive cabinet which, in addition to its handsome appearance, is a most useful piece of furniture. The side sections are fitted with lids and will hold a useful number of records, whilst there is ample room inside for the receiver and mains section. Thus the builder may choose the type of cabinet which best suits his personal taste.

Adjusting the Receiver

The adjustment is as simple as with the battery version, no intricate ganging or trimming having to be carried out. The central knob controls the wave-range, gramophone, or radio, as well as switching the set on and off. When switched on for the first time the pre-set condenser should be screwed about half-way in, and a station tuned in at the lower end of the dials. Both dials should be kept at the same settings to begin with. As soon as a station is heard, swing the right-hand condenser dial until the loudest setting is obtained, keeping the volume down by adjusting the left-hand lower control. When the maximum setting has been found, decrease volume until the signal is only just audible, and then with a strip of wood, or a pencil, rotate the trimmer on the section of the two-gang condenser nearest the panel. If this has to be at the extreme of its setting in either direction, the other trimmer should be turned slightly.

By F. J. CAMM

When this has been balanced the receiver may be left alone, and all subsequent tuning carried out with the two tuning controls. If you are in a locality

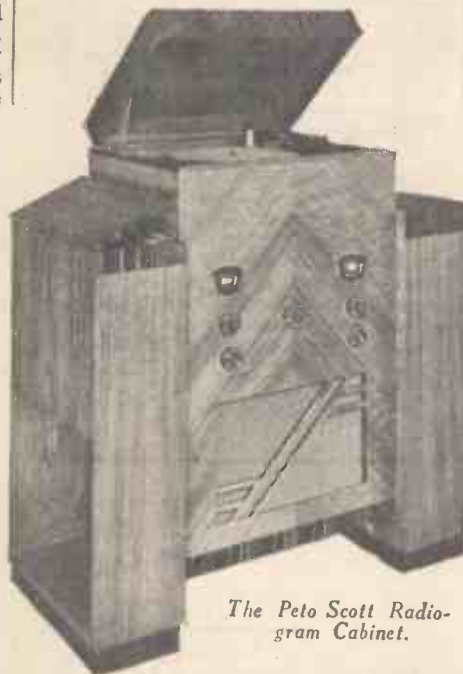

The Peto Scott Radiogram Cabinet.

where the question of selectivity is very acute, or where no selectivity troubles are experienced, you may make a suitable adjustment of the pre-set condenser to give you maximum signal strength. If you are in a particularly good district you may even find that you



The neat lay-out of the A.C. Fury Four.

can dispense with this condenser entirely, but it is worth while fitting it and adjusting it to some optimum setting in view of its effect on the aerial tuning coil. Signals may be strengthened when a very distant station is required, by the reaction control (lower right-hand), and as with the original Fury this control, when employed in conjunction with the volume control, will enable any required degree of selectivity and signal strength to be obtained. Grid bias is automatically applied so that you need have no worry regarding the correct voltage, and the arrangement of the parts will ensure that there is no hum whatsoever. Therefore if when you switch on you experience hum which is audible a foot or so from the speaker, you may immediately assume that you have gone wrong somewhere in the wiring, or some component is faulty. One of the great features of this receiver is its silent background, and this has been obtained not only in the choice of components and circuit arrangements, but in the actual lay-out which has been employed. This is, of course, another reason why no departure should be made from the published specification and design.

Tests and Results

The receiver has been thoroughly tested and has proved an exceptionally good station-getter. As my readers know, we do not favour the idea of stating that such-and-such a receiver will get forty stations, as conditions in different parts of the country vary to such an extent that a reader may be led to expect either too much or too little from a receiver, and in addition conditions in each locality vary from night to night. With this particular receiver, for instance, it was found possible to obtain good loud-speaker signals from all the B.B.C. stations, Brussels No. 1, Prague, Langenberg, Rome, Munich, Leipzig, Berlin, Leningrad, Milan, Poste Parisien, Hilversum, Heilsberg and Fécamp on the medium-waveband, in addition to National, Huizen, Radio-Paris, Deutschlandsender, Eiffel Tower, Warsaw, Oslo, and Leningrad on the long waves. All these stations have proved particularly reliable in the situations in which the "A.C. Fury Four Super" has been tested, and no reader should experience difficulty in receiving quite as many stations, although those received might be different, according to the actual locality in which the set is installed. Selectivity is a remarkably good feature and interference has in every case proved to be very slight.

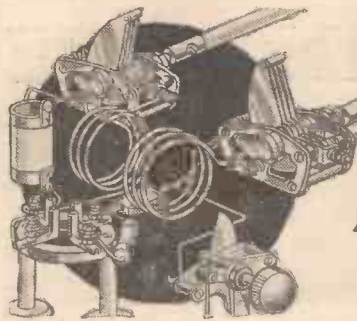

Short Wave Section

A SHORT-WAVE WAVEMETER.

Some Practical Notes Regarding a Useful Instrument.

FINDING "landmarks" on the short waves is always a difficult business owing to the extra care required in tuning the receiver, and also because of the experimental nature of many of the transmissions whose wavelengths consequently differ often from the published lists. As a rule it may be said that the owners of short-wave sets rarely possess a receiver permanent enough to calibrate. Some form of wavemeter, therefore, is more of a necessity than a luxury.

Of the more common types, the heterodyne is undoubtedly the most accurate, but is the most expensive to construct; any change

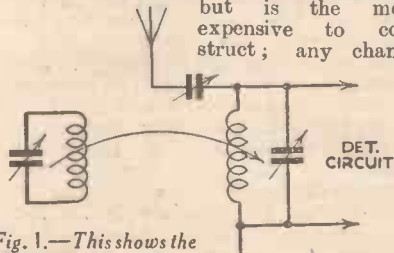

Fig. 1.—This shows the tuning circuit of a typical short-wave receiver loosely coupled to the wavemeter.

of valve also necessitates re-calibration. A buzzer wavemeter has the virtue of simplicity, but makes small pretence to accuracy by reason of its very flat tuning. Equally simple is the absorption circuit, which is the cheapest of all to construct and, if intelligently used, is accurate enough for all normal purposes; in the hands of a tyro, however, it can be very unsatisfactory. Let us examine the requirements of a really good instrument.

Fig. 1 shows the tuning system of a conventional short-wave receiver, the coil of which is loosely coupled to the wavemeter; the latter, it will be seen, consists of a tuning condenser and coil only. The constructional side of the instrument calls for little explanation; the important point to bear in mind is the absolute necessity for complete rigidity throughout; the condenser must be a really sound job—a few extra shillings spent on this will

save future trouble and ensure permanence of calibration. Equally important is the coil, which can easily be made by winding about half a dozen spaced turns on a 3in. ribbed former; this, in conjunction with a .0002 mfd. condenser, will tune from under 20 metres to 50 metres or more.

Calibration

The actual calibration need present few difficulties. A piece of squared paper should be obtained, the vertical ordinate being marked off in wavelengths and the horizontal one in dial divisions, although it makes no difference if this is reversed. The receiver should then be tuned to a station whose wavelength is definitely known—one of the Empire broadcasting transmitters is suggested—and so tuned that the beat note caused by the oscillating detector is almost zero, thus indicating that

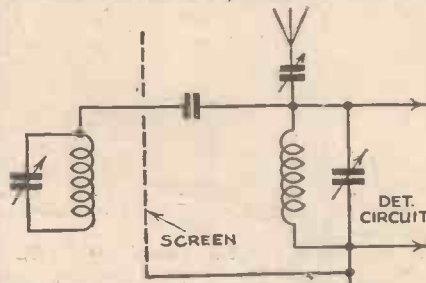

Fig. 3.—The capacity system of coupling the wavemeter.

the receiver is, for all practical purposes, dead on tune. The wavemeter coil must then be brought near to the receiver coil, but not closer than about six inches, and the dial slowly rotated; a point will be found where the receiver will probably stop oscillating, as denoted by a pop in the 'phones and a cessation of the beat note.

If this happens, the wavemeter should be taken farther away from the receiver and the whole procedure repeated. The reason for this is that too much absorption by the meter causes "pulling" between the two circuits, a condition which militates against good calibration. A point will again be found where the two circuits are in tune, the indication this time being given by a sudden change in pitch in the beat note. This will give point number one on

the graph. Other points may be obtained in a like manner by using other stations of known

frequency. If the wavemeter condenser is of the square-law type the resulting curve should be sensibly a straight line, although at low dial readings there will probably be a pronounced curvature caused by the self-capacity of the coil, as shown in Fig. 2. Any points which lie completely off the obvious curve should be disregarded as inaccurate. It would be as well to point out at this juncture that the proper way to draw a graph of this nature is not to join point to point, but an average line should be drawn which indicates the true graph, after allowing for the personal error and any other inaccuracies such as slight faults in condenser design.

Capacity Coupling

As explained above, the

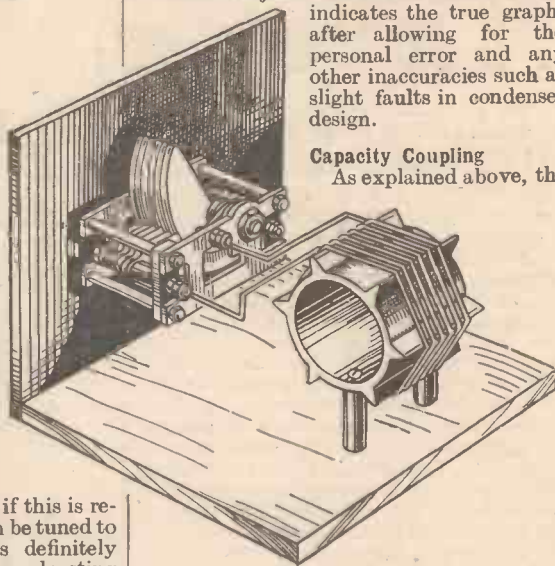

Fig. 4.—A pictorial view of the wavemeter described.

greatest accuracy will be obtained by using the meter with a very weak coupling between the coils. Now, at the best of times, inductive coupling is always rather an uncertain quantity if made variable. In order to overcome this drawback the writer has always used capacity coupling with absorption wavemeters. Whilst, perhaps, being somewhat unorthodox, there are no disadvantages if the coupling is really weak. Fig 3 shows the capacity system. Strictly speaking, of course, the wavemeter should be entirely screened so as to avoid incidental inductive coupling. The actual coupling condenser must be very small, and in many cases need be no more than the capacity afforded by the twisting together of two insulated wires for an inch or so. Once the required degree of coupling is obtained, the wavemeter may very well form part and parcel of the receiver, with the secure knowledge that the calibration cannot vary with a fixed coupling.

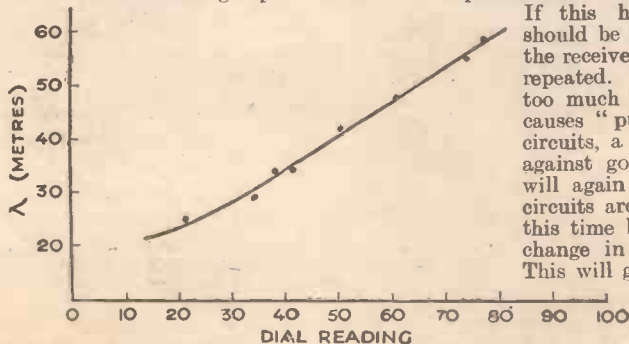

Fig. 2.—A representative calibration curve for the meter.

THE WIRELESS CONSTRUCTOR'S ENCYCLOPÆDIA

(2nd Edition)

By F. J. CAMM
(Editor of "Practical Wireless")

THIS invaluable encyclopædia is written in plain language by one of the most accomplished designers and writers on wireless construction. The whole subject is fully covered, and the volume is remarkable for the number of practical illustrations it contains.

Obtainable at all Booksellers, or by post 5/6 from Geo. Newnes, Ltd., 8-11, Southampton Street, Strand London, W.C.2.

5/-

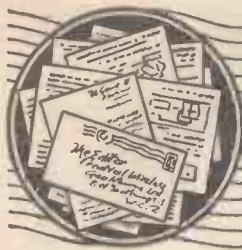

READERS' WRINKLES

THE HALF-GUINEA PAGE

A Convenient Test Panel

THE accompanying illustration shows a novel switching arrangement whereby both low-tension and high-tension can be measured quickly and easily.

TEST PANEL MOUNTED INSIDE LID OF CABINET

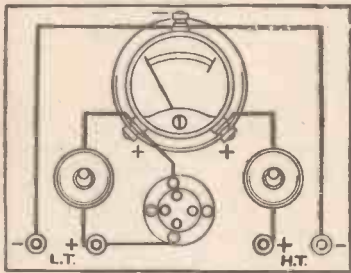
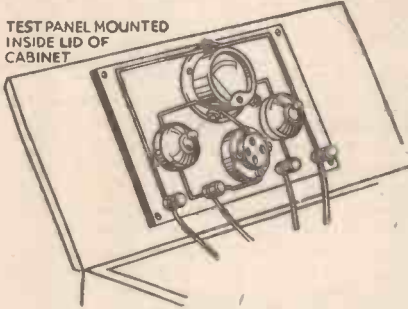

A handy test panel.

This arrangement also includes a spare valve-holder wired in parallel with the low-tension switch. Should it be feared a valve has burned out, it can be immediately tested for filament continuity by simply plugging it in to the valve-holder when a small reading should be obtained on the meter. High and low-tension batteries can also be tested both on and off load. When testing a filament it is obvious the L.T. switch must be in the off position. The test panel is fixed on the under-side of the lid of the receiver, and can be made very neat if a little care is used.—J. FOGARTY (Handsworth).

Making Transformer Spools

IN the construction of a mains transformer it is often difficult to keep flanges and separators in position without the use of glue. The following alternative method has been very successful. If the sides of the "tunnel" are made of fibre $\frac{1}{8}$ in. thick and the hole in the spool cheeks is 1 in. square, then by cutting the sides of the tunnel just over $\frac{1}{16}$ in. (only

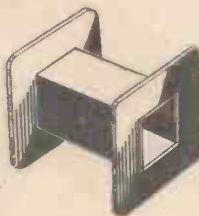
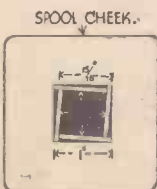

A method of making transformer spools.

THAT DODGE OF YOURS!

Every Reader of "PRACTICAL WIRELESS" must have originated some little dodge which would interest other readers. Why not pass it on to us? We pay £1-10-0 for the best wrinkle submitted, and for every other item published on this page we will pay half-a-guinea. Turn that idea of yours to account by sending it in to us addressed to the Editor, "PRACTICAL WIRELESS," George Newnes, Ltd., 8-11, Southampton Street, Strand, W.C.2. Put your name and address on every item. Please note that every notion sent in must be original. Mark envelopes "Radio Wrinkles." Do NOT enclose Queries with your Wrinkles.

a fraction) the whole can be assembled, as shown in the sketch. By pressing in the direction of the arrows the whole becomes very tightly wedged as a complete spool.

The dimensions, 1 in. and $\frac{1}{16}$ in. are, of course, taken arbitrarily, and must be adjusted to the size of stampings, etc. A spot of Secotone or other adhesive can be added, but I have never found any need to use it.—W. D. JONES (London, N.W.1).

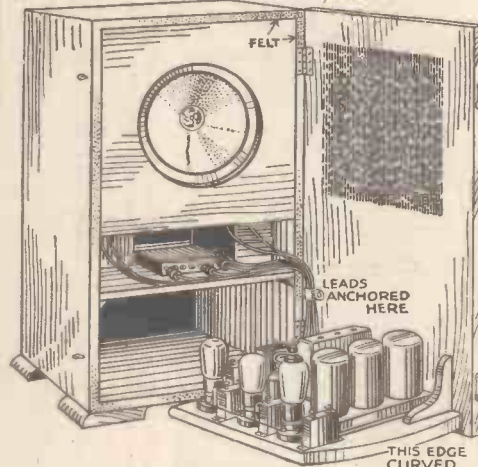

Method of mounting components to make them easily accessible.

Making the Components Accessible

THE difficulty of gaining access to the components in the set prompted me during the construction of a receiver to overcome it in as simple a manner as possible. The accompanying sketch shows the result of the slight alteration entailed. To try out a new valve, the change over takes but seconds. In the minimum of time other components can be tested or changed as desired, without, as is often the case, dismantling half the receiver.

The sketch shows that the baffle board is fastened to top and sides of cabinet, but alternatively it can be screwed to the hinged front, thus giving easy access to every component in the

receiver. All leads, from baseboard to batteries, etc., should be anchored at the point marked. This is important, otherwise the long leads may become entangled round valves, etc., when it is desired to open or shut the cabinet.—A. PICKSTOCK (Winsford.)

An Improvised Microphone Stand

AN old telephone headband was first obtained and all leather covering removed. The metal bands were then opened out to form a ring, as in sketch. Four stout wire loops were made and soldered to the wire ring, as indicated. An old tuning dial was then taken, the spindle boss of which was bored right through to take a terminal screw.

The metal band is screwed to the tuning dial by a terminal screw placed right through the spindle-boss and head-phone attachment on the head-band. It is fastened by a terminal nut on each side. The microphone can then be suspended by four thick elastic bands looped from the ring, and fixed to corresponding loops on the microphone. This arrangement works very well and is quite free from all extraneous noises.—A. W. CUOLMAN (Whetstone).

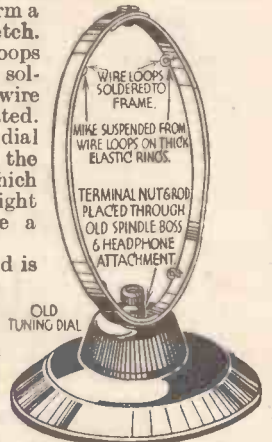

An improvised microphone stand.

A Simple Aerial and Earth Switch

A NEAT aerial and earth switch can be made as shown in the accompanying sketches. Obtain three 6BA terminals, two small screws, and an old tuning dial. Drill a hole in the dial to take a brass bush, two small holes for the screws, and three for the terminals. Countersink

(Continued overleaf)

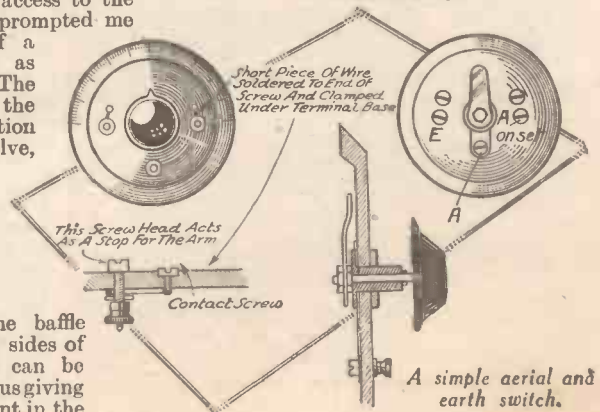

A simple aerial and earth switch.

READERS' WRINKLES

(Continued from previous page)

the holes for the small screws so that they project a little above the surface. The sketches show how the terminals and screws are connected at the back of the dial. A contact spring is clamped between two nuts on the end of a central spindle, the other end carrying the knob. The switch can be fixed in a water-tight box, if used outside the house, or at the back of a set. If it is fixed outside, an extension rod can be used for the operating knob.—T. BURROWS (Penrhwiweiber, S. Wales).

Making Grid-leaks

THE following method of making grid-leaks has been found very satisfactory. The resistance consists of a small strip of cartridge paper soaked in Indian

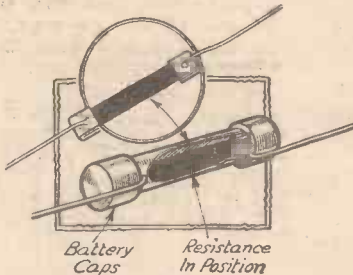

A method of making grid leaks.

ink. The ends are rubbed over with a soft pencil and small pieces of flash lamp battery brass strip pinched on to the ends to form a good contact. A short length of copper wire is then soldered to the brass ends, and the grid-leak is complete. These resistances can be fitted into a tube made from stiff paper rolled round a small diameter rod and glued. The diameter should be such that the cap off the carbon rods of an old G.B. or H.T. dry battery are a tight fit at each end.—W. J. WOODCOCK (Birmingham).

A Hair-line Dial Indicator

A NEAT and efficient hair-line tuning device for those dials on which the scale is marked, can be made in the following manner. An old variable condenser plate with a square spindle hole is obtained, and this is cut to the shape indicated by the dotted line in Fig. 1. A small piece of micanite is next cut into a square a little larger than the spindle hole. A line is scratched with a pin through the middle of the square of micanite, which is then fitted over the back of the spindle hole, the tags being bent over to hold the micanite in position. If micanite is unobtainable, a piece of thin celluloid serves the purpose just as well. A small hole is drilled in the top half of the indicator and it is then bent into the shape shown in Fig. 2. A hole is drilled in the panel, and the device

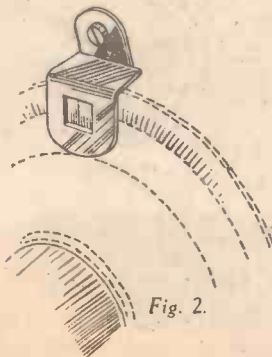

Fig. 1.
An easily-made hair-line indicator.

Fig. 2.

is mounted by means of a small screw and nut.—GEORGE THOMSON, Jr. (Glasgow, S.W.1.)

A Simple A.C. Motor

THIS simple A.C. motor may be of interest to other television enthusiasts. It consists of a wooden rotor 3in. diam. and 3/4in. thick which rotates between the poles of a laminated horseshoe magnet. The magnet is wound with 600 turns of 22 s.w.g. wire on each limb, and these coils are connected in series and tuned with a Mansbridge condenser of approx. 4 mfd. the rotor being fitted with 8 laminated insets of iron. The horseshoe magnet and insets may be made from the stampings of old transformers. This motor used on A.C. mains of 210 volts should have a synchronous speed of 750 r.p.m. The cheapness of the motor, and the fact that the mirrors of a mirror drum could be fitted round the edge of the rotor, should appeal to experimenters with limited means. My own experimental motor consisted of a child's scooter wheel 3in. diam. running between the poles of a horseshoe magnet

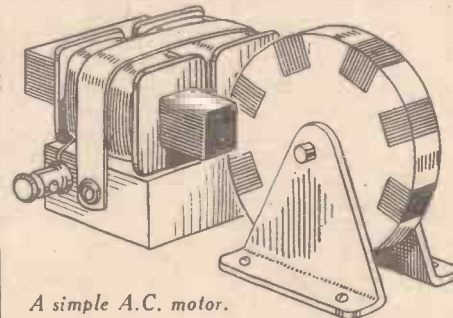

A simple A.C. motor.

made from an old mains transformer. Eight 3/4in. wood screws were screwed in each side of the wheel to serve as insets. The coils consisted of 1/2lb. of 24 s.w.g. wire, and with a suitable resistance in series it ran quite steadily for four hours on test.—J. T. CURTIS (Bristol).

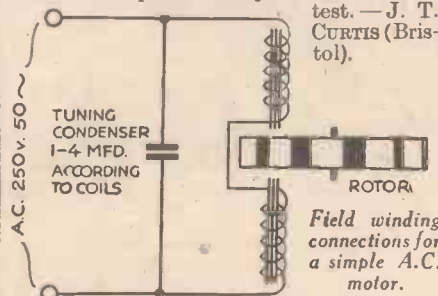

A Handy Clip Connector

WHEN making temporary connections or variable tappings in a wireless receiver the average clip used is often large and heavy compared with the wire to which it is attached. This frequently causes trouble, and in the case of short-wave sets it leads to short-circuited turns on the coil; and sometimes actual damage may be caused by the weight of the clip causing it to sag and touch some high potential connection. The use of miniature "Bulldog" clips overcomes the trouble. They are obtainable quite cheaply from any stationer's shop. Their dimensions are only 3/16in. by 1/4in. It is recommended that the spike is broken off and a small piece

of systoflex slipped over the flex connection as shown in the sketch.—L. E. SHELLEY (East Sheen).

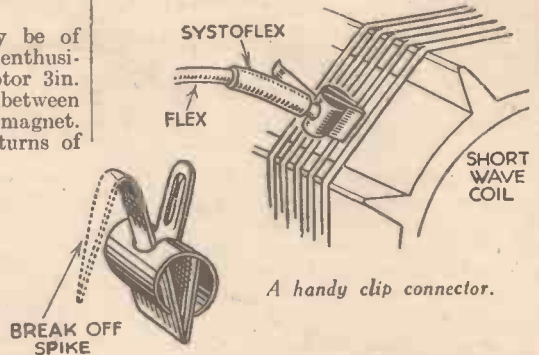

A handy clip connector.

A.C. or D.C. and Polarity Indicator

AN easy and definite manner in which to ascertain whether mains supply is A.C. or D.C., is to use an "Osglim" lamp (sold by the Osram Co. as a night light). Plug this light into any holder and note the position of the glow; then reverse the lamp in the holder. If no change is observed the supply is A.C. On D.C. supplies the glow appears around the electrode which is connected to the negative main. This effect is quite marked, and when using these lamps for lighting purposes they should always be inserted in the holders in the way which gives the glow around the wire coil as shown below at least double the light being thus obtained. If the connections to each electrode are carefully noted, the fact that the glow always appears on the one connected to the negative main provides a good polarity test.—E. W. FORSTER (Tolworth).



A novel polarity indicator.

Insulating a Screwdriver

A LONG, thin screwdriver, although extremely convenient for wireless work, is liable to be dangerous, since it can easily be the cause of a short-circuit, of of the user receiving a shock in the case of a mains receiver. It will therefore be found particularly useful to insulate the long metal blade by slipping a length of rubber tubing over it, as shown in the sketch. R. LANDELLS (Hendon, N.W.4).



Insulating a screwdriver.

Practical Television

Conducted by H. J. Barton Chapple, Wh.Sch., B.Sc., Etc.

FEBRUARY 17th, 1934. Vol. I No. 7.

BUILDING THE MIRRORVISOR

Complete Constructional Details are Given in This Article

THIS week I want to devote attention to what may be regarded as the most interesting section—namely, the construction. A complete list of the component parts used was published last week. No doubt, in many cases, the reader will be making up his very first television receiver, and it is therefore necessary to follow the instructions carefully, for the images which ultimately will be watched depend for their efficiency on the skill you apply to the work.

First of all the wooden baseboard. This can be obtained complete with the viewing tunnel and runners, but if the constructor prefers to make as much of the apparatus as he can himself, the accompanying diagrams and photographs can be referred to. The baseboard size is 20½ in. by 9½ in., by ½ in., with a rectangular section cut out from the back edge 2½ in. wide and 3 in. deep. One long edge of this section is 2 in. from the left-hand side of the baseboard facing the back, and is for the purpose of giving free movement to the base of the projection lamp when lining it up optically.

Fixing the Cell.

One of the secrets of success in building up the Mirrorvisor is to pay careful attention to the dimensions given in the accompanying diagrams for the positioning

Fig. 1 (Right)—Our artist's impression of the complete Mirrorvisor with the casing removed.

of the individual components. First consideration must be given to the metal box in which is mounted the Grid-Cell Unit. A complete dimensioned drawing is given for this, but I strongly recommend readers to purchase this box complete, and not attempt to make one up themselves.

Remove the shaped top of this box, which, incidentally, must normally be screwed down with countersunk screws and not cheese-headed ones, otherwise the screw heads will foul the individual mirrors of the drum when it is revolving, and proceed to mount the cell in place. The smaller vertical rectangular end has a 1 in. diameter hole, and into this must fit the cell. Take out the two screws, holding together the faces of the nickel and black-finished sections of the cell, and place the black-finished cell-holder section into the box hole,

so that the cell is horizontal and projecting to the right when looked at from the back of the box. Mark off the positions of the two mounting screw holes with a fine scriber, drill clearance holes for the screws, and then screw the two parts together so that the faces grip the box front between them. This will leave the adjustable lampholder inside the box so that the levered portion can be moved vertically to clip in the lamp.

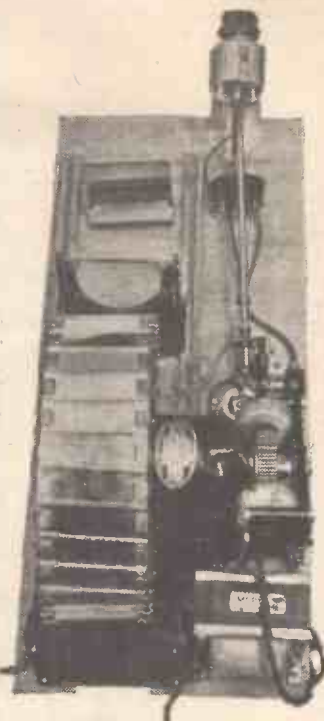
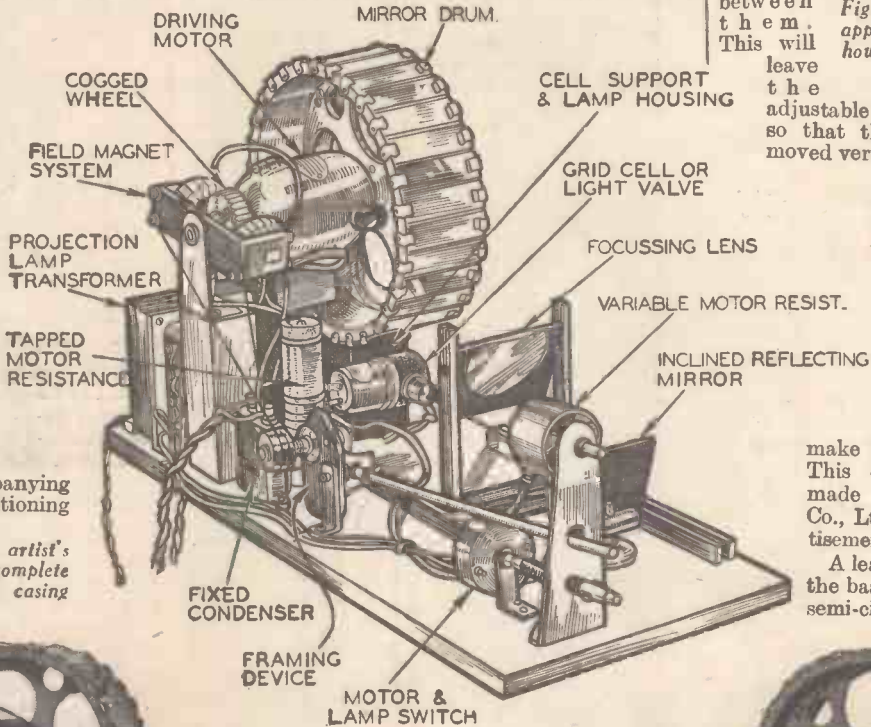

Fig. 2.—A photograph of the apparatus from above showing how compactly the parts are arranged.



Lamp Connection

Owing to the special character of the projection lamp filament, the lamp itself must be held vertically and the section cut out of the baseboard at the back allows this to be done. The lamp has a screwed base and, in consequence, it is necessary to have a special holder to make electrical connection to it. This can be purchased ready made from Messrs. Peto-Scott Co., Ltd., as listed in their advertisement.

A leaf spring makes contact with the base of the lamp, while the two semi-circular sections grip the

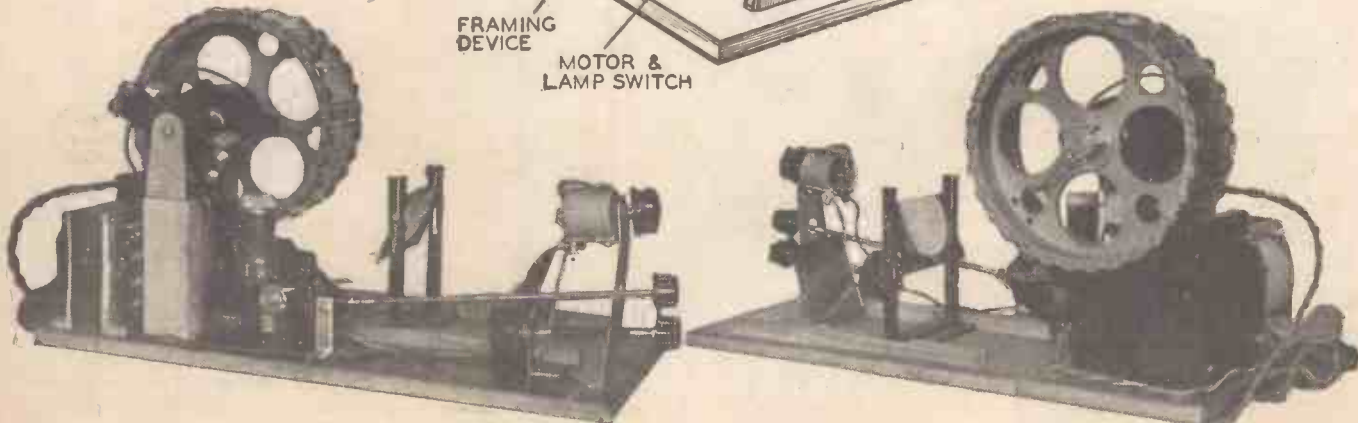
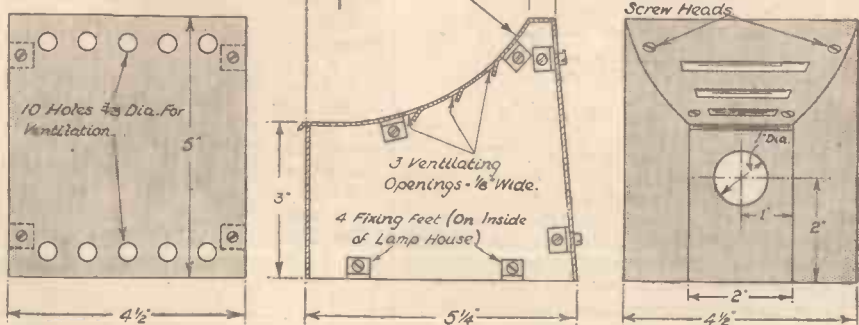

Fig. 3.—Views of the apparatus from each side, which will assist you in assembling the parts.

Fig. 4.—Details of the simple and ingenious ventilating device for the lamp.



All Black Outside Shiny Metal Inside.
1/16" Thick Aluminium.
No Bottom, Only Four Holding Down Lugs.
Aluminium Countersunk for Screw Heads.

screwed shank firmly. Attach the ends of a short length of heavy flex (this has to carry 8.5 amps., so ordinary flex is useless) to the shank and base terminal connections, leaving the other flex ends free for connecting to the mains transformer.

Remove the back of the cell box, clip the lamp into place, and then proceed to screw the box to the baseboard, so that it is positioned exactly as shown by the dimensions in the accompanying drawings. The

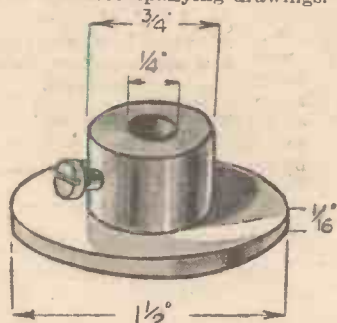

Fig. 5.—The mounting boss, fully dimensioned.

point of prime importance is that the centre line of the box and, in consequence, the beam of light passing out of the second Nicol prism of the cell, is parallel with the long baseboard edge (left one facing back) and 3in. from it, this being the optical axis. Screw on the back and top of the box with the screws provided, the slots

cut out of the top being for the purpose of allowing a forced ventilation to be produced by the revolving mirror-drum while the small "baffles" inside direct the cool air on to the lamp and also prevent any direct light escaping from the box and reaching the screen to mar the image.

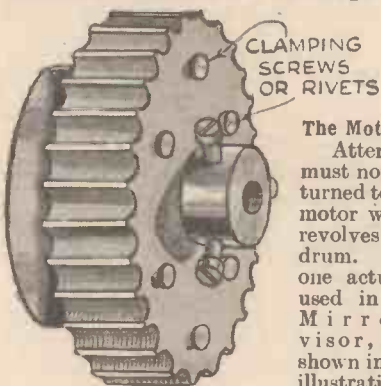
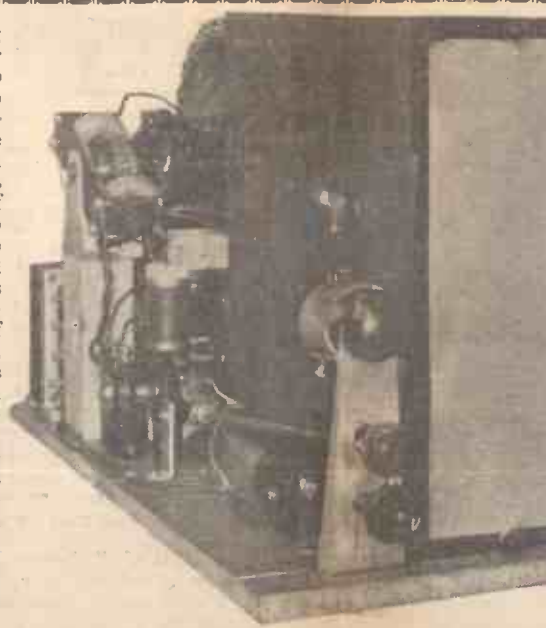

Fig. 6.—The synchronizing wheel, and the method of mounting.

This is circular at the bottom, and in order to accommodate it in its correct position on the baseboard a section of this circular base must be cut away with a hacksaw. Loosen the grub screw

holding the motor to the top of the stand, remove the motor and cut away a segment of the base so that the diametral distance is 2 1/2 in. instead of 3 9-16 in., which is the normal base diameter. Three screw holes are provided in the base for holding it to the baseboard, and it is best to allow the segmental section cut away to be parallel to two screw holes, and in this way the three holes will remain to give rigidity of support.

The normal height of the motor shaft centre from the baseboard when accommodated in the



COMPONENTS REQUIRED FOR THE "PRACTICAL WIRELESS" MIRROR

- One Universal Motor, complete with Stand (Peto-Scott).
- One 250 ohm 50 watt Variable Resistance (Peto-Scott).
- One 30 Mirrored Band Drum with flexible coupling (Peto-Scott).
- One 12 volt 100 watt Mains Transformer (British Radiogram).
- One 0.1 mfd. Fixed Condenser, Type B.B. (Dubilier).
- One Tapped Resistance Type MR12 (Bulgin).
- One Inclined Reflecting Mirror on Stand (Mervyn).
- One Cut Lens (Baird Television).
- One Double Pole Rotary Switch, Type S110, complete with 4in. Shaft and E.H.6 Bracket (Bulgin).
- One Baird Grid Cell Unit, complete (Peto-Scott).
- One Projection Lamp Connector (Peto-Scott).
- One Resistance Bracket (British Radiogram).
- One Adjustable Lens Holder (Mervyn).
- One Universal Mains Plug (Ward and Goldstone).
- One Special Cabinet (Peto-Scott).
- One Grid Cell Unit Box (Mervyn).
- Operating mechanism for adjusting synchronizing gear.
- Wood Block Support for synchronizing gear bracket.
- One Bracket for synchronizing gear.
- One Baseboard with Viewing Tunnel and Runners.
- Flex wire and screws (Peto-Scott).
- One small Bracket for Bulgin S110 switch.

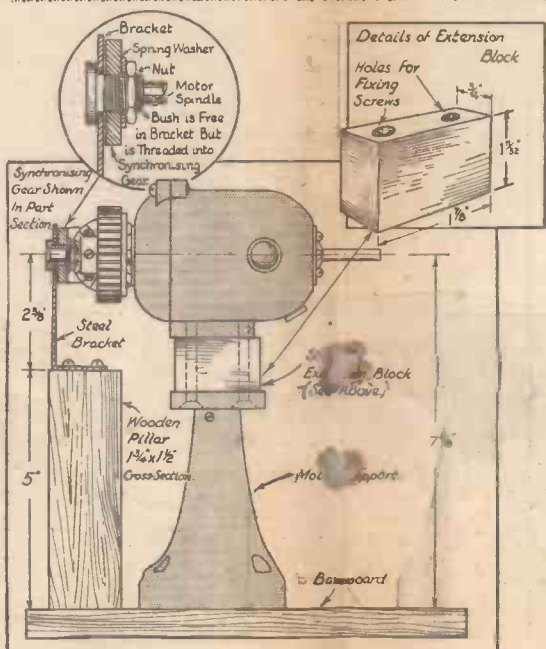

Fig. 9.—This illustration shows the motor and the method of raising the centre by means of an extension block. (See page next week)

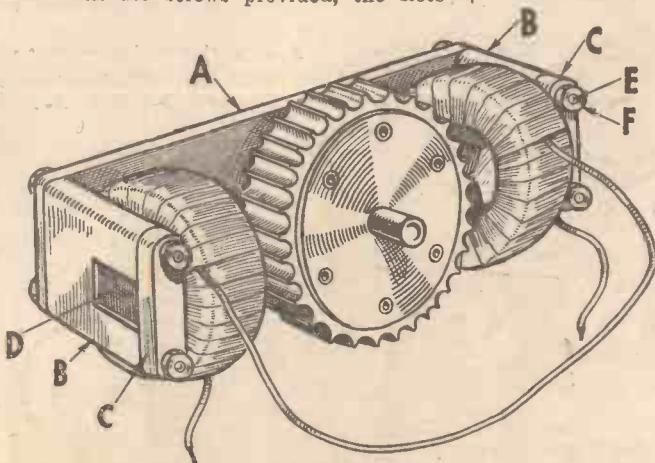

Fig. 7.—The assembly of the complete synchronizing apparatus. Note that the two magnetizing coils are wired in series.

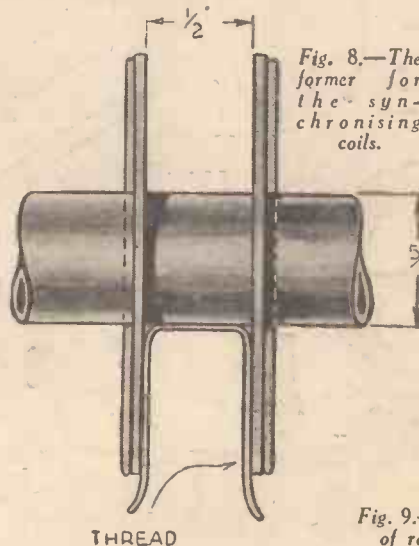

Fig. 8.—The former for the synchronizing coils.

THREAD

stand is 6in., and for this machine it is necessary to raise this by a distance of 1½in. The best way to do this is to insert a metal distance piece between the motor carcass and the small "foot" which is attached to it by two screws. File up a piece of metal 1½in. by ½in. section and 1½in. high, with two clearance holes to allow the screws to pass through. Having satisfied yourself that the top and bottom faces are flat and parallel, insert this distance piece between the carcass and the foot, replacing the existing short

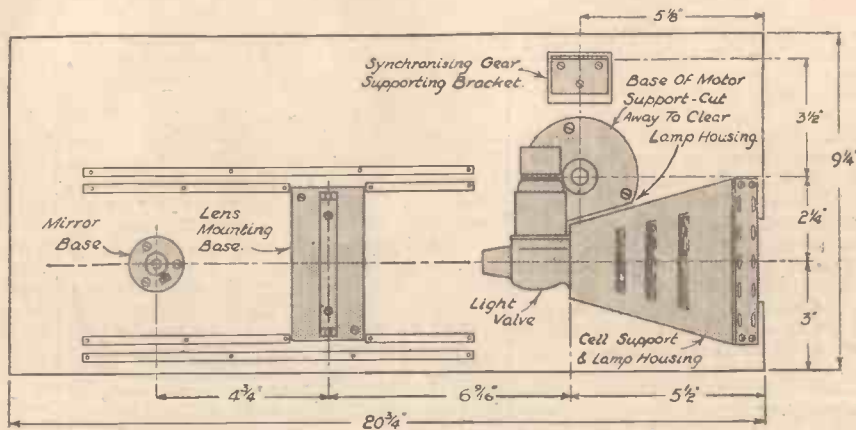

Fig. 11.—Details for mounting the respective parts on the base to maintain correct alignment.

screws with countersunk long ones, being sure that the heads do not foul the top of the motor support when in place, otherwise this will throw the motor out of centre.

At one end of the motor carcass is a brass boss held to the frame by three screws, and through which passes the motor shaft. It is at this end that the synchronizing gear is mounted, and the boss must be removed and replaced by a single brass washer the same thickness and the same diameter as the flange of the boss. Three countersunk screws will hold this in place on the carcass, the screw heads being made flush with the washer face so as not to foul the toothed wheel when fitted. Next cut off a piece of the motor shaft so that only a length of 1½in. projects beyond the washer face. At the other end of the motor—that is, the brush end—cut off another piece of the motor shaft so that it projects 1½in. from the end of the shaped cover plate.

The motor and base are now ready for fixing to the baseboard. Place the segment face of the base against the cell box side and slide it gently forward until the vertical section of the support almost touches the horizontal cylindrical portion of the grid cell. This will be seen quite clearly in the diagrams and photographs. The motor shaft at the brush end will now be

positioned over the cell box, and, before screwing the base down, place the drum on the motor shaft and rotate it slowly by

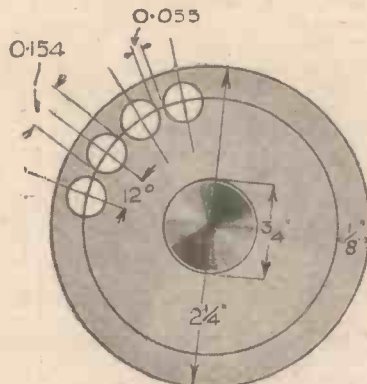

Fig. 12.—The toothed synchronizing wheel may be made by drilling holes as shown in this illustration.

hand to see that it does not in any way foul the box. If all is correct, fix the motor

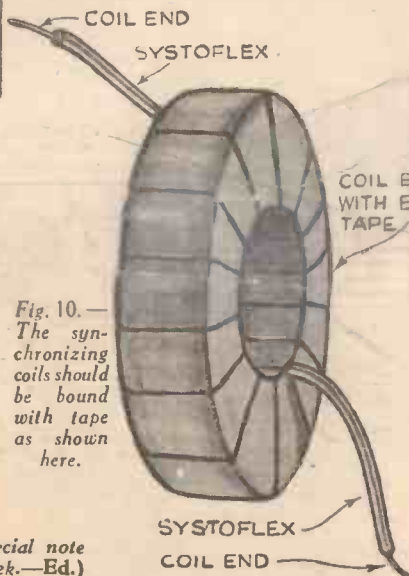
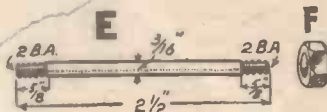

Fig. 10.—The synchronizing coils should be bound with tape as shown here.

Special note (Ed.)

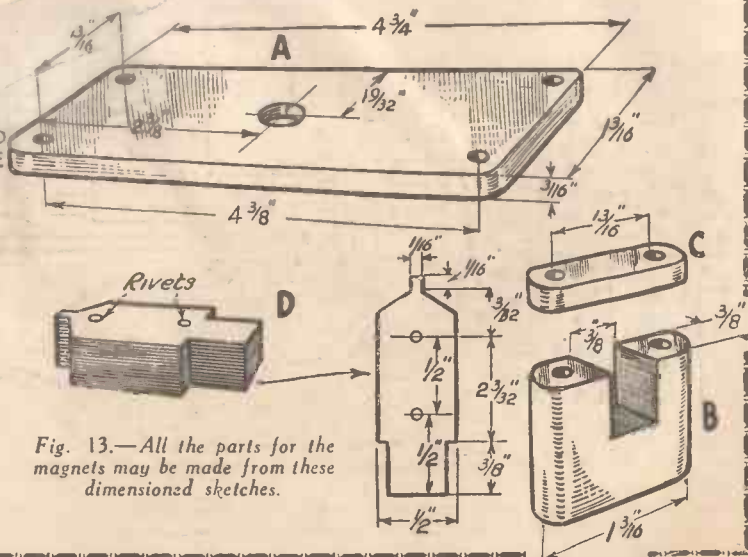

Fig. 13.—All the parts for the magnets may be made from these dimensioned sketches.

base firmly to the wooden baseboard with three stout screws.

It is as well to point out here that the drum is placed on the motor shaft so that the flexible coupling is on the outside, and, in addition, three $\frac{1}{4}$ in. washers 1-16in. thick must be threaded on the motor shaft first—that is, before the drum is attached. These three washers act as distance pieces, preventing the drum from sliding towards the motor off its own flexible coupling boss, and also positioning the centre line of the mirrors exactly over the optical axis. Remember that the drum revolves in an anti-clockwise direction facing motor end and in a vertical plane parallel with the baseboard edge, and, in consequence, the motor shaft must be at right-angles to the same edge.

Synchronizing Gear

This mechanism can be made up by the amateur himself, although, if he prefers, the individual parts may be obtained from advertisers in this journal, the assembly being quite a straightforward matter. Dimensioned drawings are included with this article, and the first thing to make up is the cog-wheel with its thirty teeth. This consists of a $\frac{3}{4}$ in. diameter mild steel boss with a $1\frac{1}{4}$ in. diameter flange, 1-16in. thick. A $\frac{1}{4}$ in. hole is drilled through the centre so that it can fit over the motor shaft. The actual length of the boss from the flange face is $\frac{3}{4}$ in.

Next, cut out eighteen discs of 22 s.w.g. sheet iron (.028in. thick), the outside diameter being $2\frac{1}{2}$ in., with a centre hole $\frac{3}{4}$ in. These are the laminations of the wheel, but before placing them on the boss mark off one ring as shown. Divide a concentric circle of 2in. diameter accurately into thirty parts by drawing the radii subtending 12 degree angles at the centre. An accurate protractor will help here. Finally, centre-punch at each of the thirty points where the respective radii intersect the 2in. circle circumference.

Place the eighteen circular "blanks" on the boss with the marked one outside and then clamp them rigidly to the boss flange by drilling six holes to take steel screws

whose countersunk heads come flush with the flange face, the threaded portions taking small nuts. Alternatively, these laminations may all be riveted together to the flange—the choice is left to the constructor.

The blank wheel now has a thickness of approximately $\frac{1}{2}$ in., and "teeth" are formed by drilling thirty holes with a No. 23 twist drill, one at each centre-punch mark, as shown. Finally, by using a fine piercing saw, cut right through the holes, keeping the blade just outside the 2in. circle. Each tooth edge must be on this circle, so it will be necessary to trim up the wheel with a smooth file, making sure that it runs dead true on the motor shaft, as this will revolve between two pole faces. As the No. 23 drill has a diameter of .154in., the resulting tooth width is .055 in. giving a ratio of about 3 to 1 between teeth gaps and teeth.

Field-magnet Assembly

The field magnet details next require attention, and complete dimensions are given in an accompanying diagram. First of all there is a mild steel back plate drilled and shaped as shown. Held vertically against this plate are two pairs of side pieces of mild steel, bolts of mild steel and nuts completing this assembly. In the centre of the larger piece of each pair is a rectangular section cut away to accommodate the laminated pole. Each pole piece is best made up from eighteen laminations of the same sheet iron as was employed for the wheel. Dimensions are given for these laminations, and each set of eighteen must be held together by a pair of rivets located in the centre. The pole facet edge is thus almost the same size as the wheel tooth edge—a condition necessary for efficient working. Accommodate each pole in the end plate section, tightening up the nuts to give absolute rigidity to the assembly.

Two field coils must now be wound, and to save space it is better to wind these on temporary formers which can be removed after the winding is complete. A suitable former is shown in one of the diagrams, a $\frac{3}{4}$ in. diameter rod having two side cheeks distanced $\frac{1}{4}$ in. apart, which, since they

must be detachable, rest against two pins passing right through the rod as indicated. Lay three or four pieces of thread in this former groove and then wind on tightly 3,500 turns of No. 37 s.w.g. enamelled wire in single layers. The end of the first turn should be brought out carefully through a small hole in one cheek, and when the coil is complete, bind it together as a temporary fixing by tying up the thread ends, slip out the cheek pins, slide the coil off the former, and bind round tightly with Empire tape, a short length of systoflex having been first slipped over each wire end. Each coil when finished will be as shown in the illustration, and these can be placed on the individual pole pieces so that they fit tightly against the vertical end pieces.

A Framing Device

In order to make due allowance for "framing the image"—that is, moving it bodily up or down so that it is central in the screen—it is necessary to be able to rotate slightly this field-magnet system. To make this a panel control the following plan was adopted.

First of all, the pole assembly had to be mounted separately from the motor, but still allowing the toothed wheel to rotate between the pole faces. A length of wood, 5in. high, having a cross section $1\frac{1}{2}$ in. by $1\frac{1}{2}$ in., was attached to the baseboard in the position shown by three long countersunk head screws passing right through from the underside. A right-angled bracket, having a $\frac{3}{4}$ in. hole drilled with its centre $2\frac{1}{2}$ in. from the foot (this gives a total of 5 plus $2\frac{1}{2}$ equals $7\frac{1}{2}$ in., which is motor-spindle centre height), is then obtained, and with a screwed brass bush, $\frac{3}{4}$ in. diameter and $\frac{1}{4}$ in. diameter flange, the back-plate of the field-magnet assembly is held to the bracket as indicated by a nut and spring washer. This allows partial rotation of the back-plate and field coils, and the base of the bracket is screwed down to the top of the wooden support so that the motor shaft is central with and passes through the brass boss. The cogged wheel is held to the motor shaft by one or more grub screws.

(To be concluded next week.—Ed.)

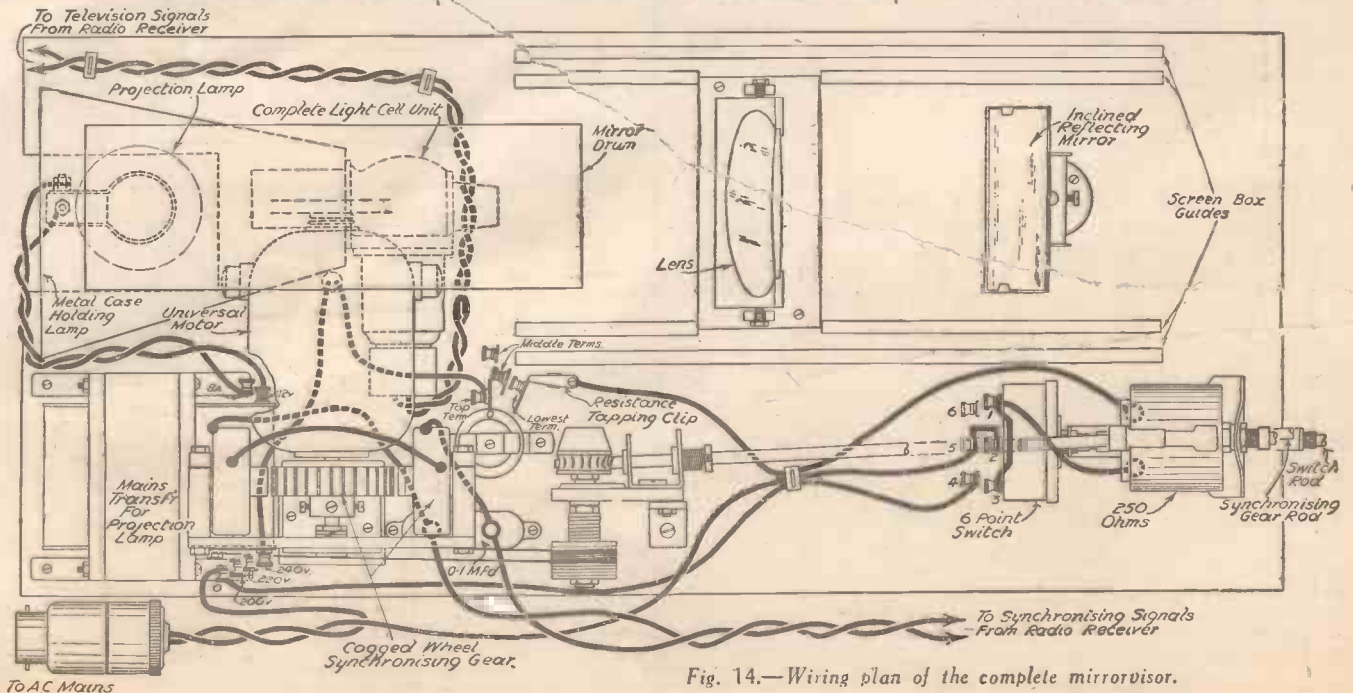

Fig. 14.—Wiring plan of the complete mirrorvisor.

THE EASY ROAD TO RADIO

THE BEGINNER'S SUPPLEMENT



TREAT YOUR SET WITH CARE

This Article Explains How the Use of Unnecessary Force in Assembly or in Operation May Damage Your Set, and also Gives Hints on Repairing Damage Caused by Rough Handling

WE have all met the heavy-handed type of individual, who makes a hash of any job calling for the slightest degree of manual skill or dexterity—the kind of person who uses a hammer in building a wireless set! However, it is not to this type that this article is addressed, but to the amateur constructor who, through lack of knowledge rather than through any inherent clumsiness, may unwittingly damage his set during the actual construction, or in handling it after it is complete.

The Art of Panel Drilling

Usually, the first job undertaken in constructing a set is the drilling of the panel. The whole secret of obtaining a professional appearance lies in the method of handling the drill. For wood or

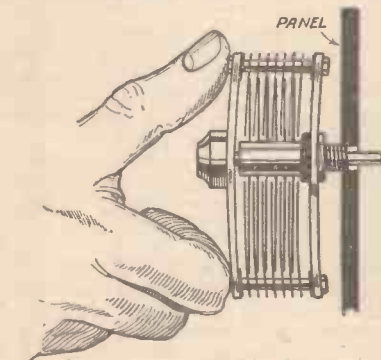

Fig. 1.—Showing how a variable condenser may be warped by forcing the spindle through a hole too small for it.

ebonite panels a cheap type of drill to use is the ordinary centre-bit. It should be held in a brace and turned slowly without using very much pressure. If it is turned very quickly, at the same time pressing heavily on the brace, it is quite possible for the bit to burst clean through the panel after two or three turns and leave a very unsightly ragged edge to the hole.

The correct procedure is to drill slowly until just the point of the drill shows through the panel, then to reverse the work and to start from the other side. After a few turns the hole will be finished, leaving a clean edge on both sides of the panel.

Having finished drilling the panel, particular care should be taken that no force is used in mounting the components on it. For instance, it sometimes happens that there is no drill handy of exactly the size to provide clearance holes for the

spindles of the various condensers, switches, etc., and that in drilling the panel, one of a slightly smaller size is used. Of course, the correct thing to do in a case like this is to ream the holes out slightly with a round file—or even a pen-knife, but it is always a great temptation

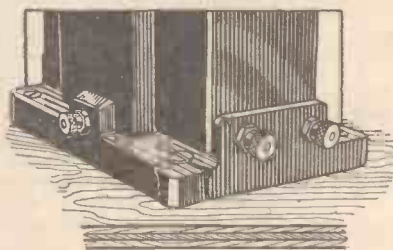

Fig. 2.—A broken flange may easily result from too much force in driving home a screw.

to force the spindles through the holes, especially if the holes are only a shade too small. What is most likely to happen in the case of an air-spaced variable condenser is very clearly illustrated in Fig. 1. The effect is, of course, exaggerated in the drawing, but nevertheless, with modern condensers with their closely-spaced vanes, it only requires a slight warping of the frame to cause the vanes to touch one another. The fact that the damage has been done may not be noticed at the time of assembly, so that it is not until the set refuses to function that the

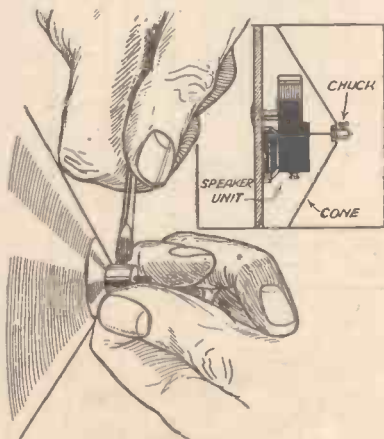

Fig. 5.—When adjusting the cone of a moving-iron speaker it should not be fixed on to the rod, but should be allowed to take up its own position before the chuck is tightened up.

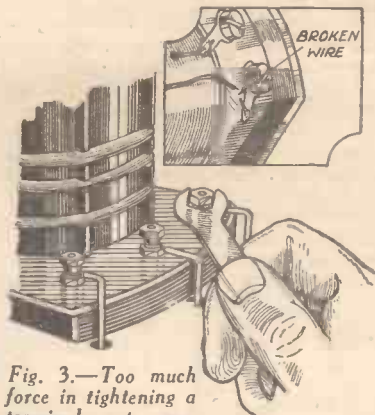

Fig. 3.—Too much force in tightening a terminal nut may cause the whole terminal to rotate and so break the connecting wire to the inside of the component.

constructor becomes aware of it. Then if it happens to be a tuning condenser, it will be manifested by crackling noises or a complete cut-off of reception over some parts of the tuning scale. If the warping is not very bad, a remedy can sometimes be effected by a reversal of the process which caused the trouble, that is by removing the condenser, laying it on the bench and pressing on the frame from the opposite side.

In the case of an air-dielectric condenser used for reaction purposes, the results of the vanes touching one another would be

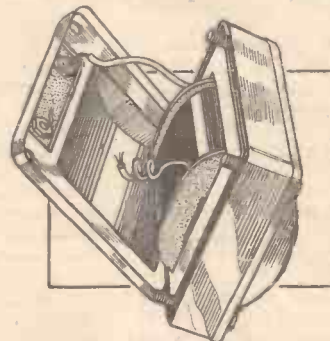

Fig. 4.—A transformer opened revealing a broken connection due to over-tightening the terminal.

far more serious, for the simple reason that it would cause a partial short circuit of the high-tension battery. Usually the reaction condenser forms the only barrier which prevents a direct connection between the plate of the detector valve and earth or "H.T." If this condenser becomes short-circuited due to the vanes touching one another, then there is a direct path from H.T. positive, through the primary of the L.F. transformer (or through the anode resistance), thence through the H.F. choke and the reaction coil to H.T. negative. If an H.T. battery is used it will become discharged, with possible injury to the transformer and choke. In the case of a mains set, there is still the risk to the transformer and choke.

Bakelite Is Brittle

In fixing components to a chassis or baseboard, many constructors are inclined
(Continued overleaf)

THE BEGINNER'S SUPPLEMENT

(Continued from previous page)

to over-estimate the force required in driving in the screws. This is a case where one good turn does *not* deserve another. Bakelite, of which many components are constructed, although excellent in many ways, is rather brittle and, if a screw is driven too forcibly into a fixing-down flange, it may split it, as in Fig. 2. Actually, such damage is often caused as much by using too large a screw as by excessive force. The shank of the screw, being tapered, acts like a wedge in the hole and splits the flange.

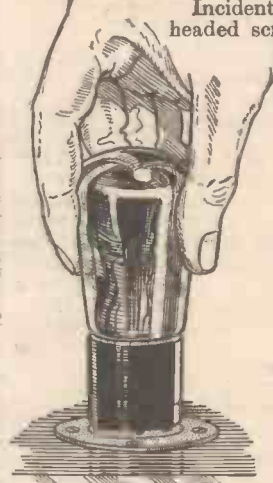

Fig. 6.—The wrong way to remove a valve.

Incidentally, if flat-headed screws are used, the holes should be counter-sunk so that the heads may lie flush with the surface of the flange. A countersinking bit may be purchased for a few pence.

When wiring up, it is usually sufficient to tighten all the terminals by hand, with perhaps an extra turn with the aid of a pair of pliers, or a small spanner to make

certain they will not work loose later on. There is no need to tighten them down like a mechanic does the body-bolts of a car. It only flattens the loop in the end of the connecting wire and may cause the whole terminal to turn round in its seating. If this should happen there is the possibility of the connecting wire from the inside of component to the shank of the terminal becoming broken. How this may occur in the case of a tuning coil is shown in the inset in Fig. 3. Tightening the nut too fiercely has caused the whole terminal, including the soldering tag underneath, to turn round—thus breaking the wire which was connected to the tag. In this particular case it was easy to see what had happened by turning the coil upside down, and the damage was easily repaired. However, more often than not the component is sealed, and it is impossible to get at the "works" without breaking it open. The obvious moral is:—"Don't be too energetic with the spanners."

Fig. 4 shows an L.F. transformer of the shrouded type, which can be easily taken apart, and in this case again the effects of twisting the terminal are clearly revealed. In this instance a transformer which might have been discarded as being "burnt-out" is shown to be suffering from nothing more serious than a broken terminal connection. Incidentally, if you happen to have any old transformers in your "junk box" which you have thrown away as "duds," you might find it worth your while taking them apart to see if the defect is not due to the same cause.

A Loud-speaker Hint

A good instance of mis-applied force was demonstrated recently to an amateur who complained of the quality of reproduction from his portable set. It transpired that he had recently dismantled the receiver, and in doing so, had noticed that the cone of the speaker was not very firmly attached to the operating rod from the unit. He therefore pushed the cone hard on to the rod and tightened up the chuck as in Fig. 5. The tension on the rod was so great that the moving-iron, or reed, was forced up against the poles of the magnet and no amount of twiddling of the adjusting knob on the unit would alter matters. Of course, he acted purely in ignorance of the principle of the speaker. With this type of instrument, if the cone is in proper alignment, it should slide freely on the rod and can usually be pushed in and out about $\frac{1}{16}$ in. due to the flexibility of the fabric ring which joins the outer edge of the cone to the baffle. The cone should not be pulled outward nor yet pushed in, but allowed to take up a natural position. It should then be firmly fixed to the rod by tightening up the chuck.

A Wiring Point

It is often urged upon the constructor to keep all connecting wires as short and direct as possible. Generally speaking, this is sound advice; but there are some instances where wires can be too short. For example, in a set of the panel and

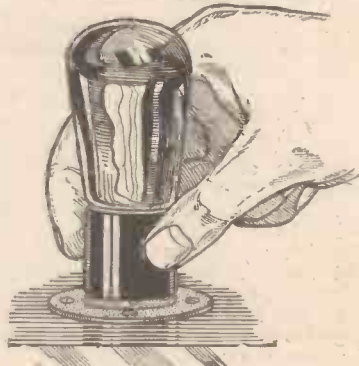

Fig. 7.—The right way.

baseboard type, there are usually a number of connections from the components mounted on the panel to those on the baseboard. If these wires are absolutely straight and rigidly fixed at each end, they will act as a sort of bridge between the panel and baseboard, and any slight movement of the one in relation

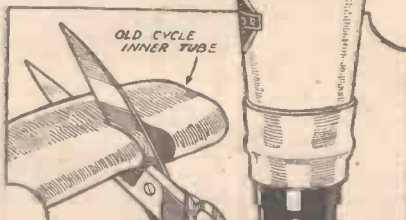

Fig. 8.—How a loose valve cap can be repaired with a rubber band cut from an old cycle tube.

to the other will set up a strain on the wires.

Of course, if the panel and baseboard were both of very stout material and rigidly bracketed together there would be no relative movement, but this state is not often found in practice, and it is not unusual to find that soldered connections have fractured due to the strain on stiff wires set up by the warping of a wooden baseboard.



Fig. 9.—A case where one good turn does not deserve another. Screwing a compression condenser down too hard may result in pushing the bottom out.

Even the push-pull action of a filament switch will cause the panel to bend slightly each time the switch is operated, and so set up a strain on the wires which may eventually break or loosen the connections.

Naturally, the obvious remedy is to have the wires slightly longer than necessary and make a small bend near one end.

Care of Valves

After assembly, one of the first jobs is the insertion of the valves. There is little risk of damage here, but in removing an ordinary glass valve there is a right and a wrong way. The wrong way is to grasp the bulb as in Fig. 6, for if it is a tight fit in the holder, as is often the case, there is a risk of the cement coming unstuck and the bulb becoming loose. A twist of the bulb is then all that is necessary to break the internal connections. The right way is to grasp the cap, as in Fig. 7.

Should the bulb of a valve accidentally become loose in its cap, a good makeshift repair can be carried out by placing a wide rubber band round the joint as in Fig. 8. Such a band can be made by cutting up an old cycle inner tube. The fact of the band being placed round the valve also gives one visible warning of its condition, reminding one to handle it with care.

Alternatively, it is sometimes possible to effect a repair by inserting a little liquid glue into the space between the bulb and the cap, and then putting the valve aside until the glue has set. A rubber band stretched over the top of the bulb, and passing underneath the cap between the pins, will hold the bulb and cap in close contact until the glue has set.

Handle with Care!

In operating your receiver the same care should be used as in assembly. Nothing is gained by swinging the controls violently backwards and forwards over the whole circuit of their range, or by banging the top or sides of the receiver in an endeavour to "ginger it up," should it appear to be working erratically. If banging the set does have any effect, it usually denotes a loose connection somewhere and more banging will only make matters worse.



F. J. CAMM'S FURY SUPER A.C. RADIOGRAM



The Pilot Kit SERVICE was founded in 1919.

PILOT AUTHOR KIT EXACT TO SPECIFICATION

See the PILOT on the carton. It's a real guarantee.

CASH BARGAIN



PETO - SCOTT
MAINS UNITS

D.C. MODEL

A wonderful opportunity to possess a guaranteed PETO-SCOTT Eliminator. 20 m/a output at 120 volts. 4 Tappings. Soundly constructed in metal case.

Cash or C.O.D.
12/6
Carriage Paid.

As above but with 25 m/a output. Cash or C.O.D. Carriage Paid, **15/-**
For A.C. Mains, 120 volts, 25 m/a, 4 Tappings. Cash or C.O.D. Carriage Paid, **37/6**

NEW BLUE SPOT PERMANENT MAGNET MOVING-COIL SPEAKER 29 P.M. With Input Transformer. Cash or C.O.D. Carriage Paid, **£1/12/6**

Send **5/-** only

Balance in 6 monthly payments of 5/-.
NEW W.B. P.M. 4A. MICROLODE PERMANENT MAGNET SPEAKER, complete with switch-controlled multi-ratio input transformer. Cash or C.O.D. Carriage Paid, **£2/2/0**.

Send **5/9** only

Balance in 7 monthly payments of 5/9.
CELESTION CLASS "B" UNIT, "B" Stage 9. Combined Class "B" Unit and P.P.M.O Moving-coil Speaker. Cash or C.O.D. Carriage Paid, **£2/15/0**.

Send **5/-** only

Balance in 11 monthly payments of 5/-.
NEW BLUE SPOT "CLASS B" OUTPUT STAGE. As advertised. Complete with Osram B21 "Class B" Valve. Less Speaker. Cash or C.O.D. Carriage Paid, **43/6**.

Send **4/-** only

Balance in 11 monthly payments of 4/-.
WREN-EASTON 3 KIT with ready-drilled panel, metaplex baseboard, less valves and cabinet. Cash or C.O.D. Carriage Paid, **£4/10/0**.

Send **8/3** only

Balance in 11 monthly payments of 8/3.
NEW LISSEN 7-VALVE SUPER-HET CHASSIS MODEL, complete with Lissen Valves in Sealed Carton. Cash or C.O.D. Carriage Paid, **£8/17/6**.

Send **15/-** only

Balance in 11 monthly payments of 16/6.
ATLAS C.A.25, for mains, class "B" and Q.P.P. Four tappings: 60/80, 50/90, 120, 150, 25 m/a. Cash or C.O.D. Carriage Paid, **£2/19/6**.

Send **6/-** only

Balance in 10 monthly payments of 6/-.
AVOMINOR TEST METER. Cash or C.O.D. Carriage Paid, **£2/0/0**.

Send **5/6** only

Balance in 7 monthly payments of 5/6.
TELSEN H.T. Unit FOR D.C. MAINS V.348. 200-250 v., 28 m/a at 150 v., 3 tappings: Max., S.G. and Det., each adjustable for High, Med. or Low voltages. Cash or C.O.D. Carriage Paid, **£1/15/0**.

Send **6/6** only

Balance in 5 monthly payments of 6/6.
ADDS MORE STATIONS to your present set.

The PETO-SCOTT LONG-RANGE UNIT solves the problem of distance getting. Brings sets right up-to-date, increases range and sensitivity and enables you to tune-in at full strength distant foreigners which can only be heard faintly at present. The Amplifier is easily fitted and necessitates no alteration to your existing receiver—just tap in on the Aerial and Earth leads. This amplifier can be attached to any set, except one already possessing a high-frequency amplifier.

YOURS FOR 5/-
Balance in 8 monthly payments of 5/3.

RADIOGRAM

RECEIVER PORTION. Authors' Kit of Specified Parts, including Peto-Scott METAPLEX Chassis ready drilled but less valves, Cabinet, and Speaker. Cash or C.O.D. Carriage Paid. **£8-2-6**

Or 12 monthly payments of 15/-.
POWER PACK. Kit of Authors' First Specified Parts, with Metal Rectifier. Cash or C.O.D., Carriage Paid, **£4-1-9**

Or 12 monthly payments of 7/6.
COMPLETE KIT. Comprises Receiver Portion and Power Pack with set of Specified Valves and PETO-SCOTT Fury Super Walnut Radiogram Cabinet as illustrated and described below, less Speaker and Gramo. equipment. Cash or C.O.D. Carriage Paid. **£21-7-6**

Or £5/7/6 deposit and 11 monthly payments of 32/-.
With Peto-Scott Permanent Magnet Moving Coil Speaker, if required, add 19/6 to Cash Price or 1/9 to each monthly payment.

If Collaro Combined Pick-Up-Motor Unit required, add £4/0/0 to Cash Price or 7/3 to each monthly payment.

PETO-SCOTT FURY SUPER WALNUT RADIOGRAM CABINET EXCLUSIVELY SPECIFIED



Exquisitely designed with accommodation for Radio and gramo equipment, record compartment and bookshelves.

DIRECT FROM FACTORY TO YOU YOURS FOR 13/6

An outstanding Cabinet of real beauty and utility. Built by master-craftsmen. Real inlaid walnut, mortised, tenoned, French polished. Handsome contrasting macassar veneer. With 2 record compartments and book-shelves. Baffle board 3/8 extra. Cash or C.O.D. Carriage Paid, **£5/16/0**. As above but fitted with A.C. Gramophone Motor with Tone Arm, Pick-up and Volume Control and Automatic Needle Cup. Cash or C.O.D. Carriage Paid **£10/0/0** or 21/- down and 17 monthly payments of 12/8.

Internal Dimensions
Set Section: 9in. high, 19in. wide, 14in. deep.
Speaker Compartment 17in. by 19in. by 14in. Baseboard depth 14in.

SEND FOR 1934 CABINET CATALOGUE.

IMPORTANT Miscellaneous Components, Parts, Kits, Finished Receivers or Accessories for Cash, C.O.D. or H.P. on our own system of Easy Payments. Send us a list of your wants. We will quote you by return. C.O.D. orders value over 10/- sent carriage and post charges paid (GREAT BRITAIN ONLY). OVERSEAS CUSTOMERS CAN SEND TO US WITH CONFIDENCE. We carry a special export staff and save all delay. We pay half carriage—packed free. Send full value plus sufficient for half carriage. Any surplus refunded immediately. Hire Purchase Terms are NOT available to Irish or Overseas customers.

RADIO In Every Room!

PETO-SCOTT Permanent Magnet Moving-Coil 1934 EXTENSION SPEAKER

Suitable Output for 1001 Receivers. With inclined baffle, supported on felt cushions—Free from all resonance and boom—enhancing the already perfect tonal balance. In Beautiful WALNUT CABINET, suitable for any type of set or output valve. Direct only from PETO-SCOTT.



30 RATIOS
5/- DOWN

Balance in 7 monthly payments of 5/6. CASH or C.O.D. Carr. Paid, 39/6. Speaker only (less cabinet) Cash or C.O.D. Car. Pd. 29/6 or yours for 4/- down and 7 monthly payments of 4/-.

CONVERT YOUR SET to a FIRST-CLASS RADIOGRAM —efficiently and instantly with the



UNIGRAM

Quickly adapted—even by the most inexperienced—to any set which already has pick-up terminals or socket. A job of a moment to connect leads to your present set or mains supply. It's then ready to play. Includes first-class A.C. electric Gramophone Motor, Automatic Stop, Universal Pick-up, Volume Control. Complete in attractive modern cabinet. Cash or C.O.D. (carriage paid), **£4/19/6**, or yours for 5/- down; balance in 10 monthly payments of 10/6.

paid), £4/19/6, or yours for 5/- down; balance in 10 monthly payments of 10/6.

TELSEN

"MODERN RADIO ENGINEER" KITS

TELSEN EXPERIMENTAL 3 KIT, less valves. Cash or C.O.D. Carriage paid, **£3/2/0**. Balance in 11 monthly payments of 5/9 only.
TELSEN CLASS "B" 4 KIT, less valves. Cash or C.O.D. Carriage Paid, **£4/9/0**. Balance in 11 monthly payments of 8/3 only.
TELSEN S.G.3 KIT, less valves. Cash or C.O.D. Carriage Paid, **£1/19/6**. Balance in 9 monthly payments of 4/6. If values required add £1/19/0 to Cash Price; H.P., 12 monthly payments of 7/3.

PETO-SCOTT Co. Ltd. 77, City Rd., London, E.C.1

Telephone: Clerkenwell 9400-7. West End Showrooms, 63, High Holborn, London, W.C.1. Telephone: Holborn 3248

Dear Sirs.
(a) Please send me
(b) I enclose Cash/Deposit
NAME
ADDRESS P.N. 17/2/34

ANY ITEM SUPPLIED SEPARATELY—ORDERS OVER 10/- SENT C.O.D. CARRIAGE AND POST CHARGES PAID

An Ideal Receiver for Family Use

A Description of an Interesting Receiver Employing an Unusual Circuit Arrangement. By G. W. DAVEY

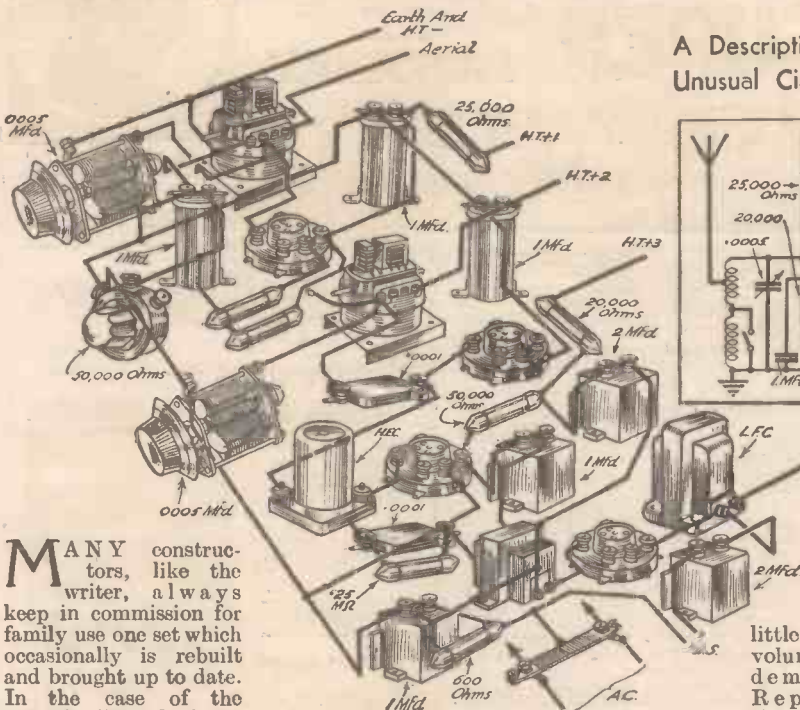
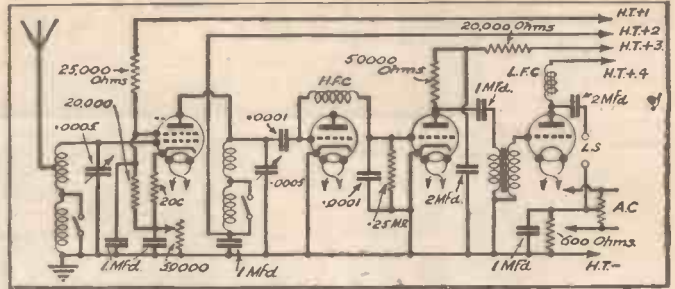

Fig. 1.—Theoretical and pictorial circuits of the receiver described.



obtainable with this circuit, due to the almost perfectly linear rectification given by the diode detector, a good transformer and loud-speaker are most definitely advised.

Reaction

Having found the circuit so successful so far, using the reactionless diode, it was decided to try the addition of reaction in order to increase the station-getting powers of the set.

The first scheme tried was the standard method of obtaining reaction from the diode. It is to use the plate of the three-electrode valve which is being worked as a diode and to obtain reaction from that; the diagram shown in Fig. 2 gives the details. Very careful decoupling was found necessary, but ultimately delightfully smooth reaction was obtained. It was immediately discovered, however, that the reaction was entirely negative in its effect; that is to say, instead of performing the normal and necessary purpose of giving increased volume, operation of the reaction control merely gave perfectly controllable oscilla-

MANY constructors, like the writer, always keep in commission for family use one set which occasionally is rebuilt and brought up to date. In the case of the writer's "family" set this is done about every six months, the latest reconstruction having taken place just recently. As the set that had been in use was of fairly good design it was found rather difficult to bring it further up to date, so search was made regarding any points wherein improvements could be made. The set in use was multi- μ screen-grid, detector and pentode, all A.C. driven, and although its operation was very satisfactory, overloading of the detector, and also of the pentode, became apparent directly a

little extra volume was demanded. Reproduction, also, was clean-cut and clear,

but rather lacking in bass, however much tone correction was used on the pentode output circuit, so, after some thought and experiment, the circuit shown in Fig. 1 was devised. It will be seen that the variable- μ screen grid valve is retained, feeding a three-electrode valve used as a diode detector. This is coupled to an L.F. stage, which is followed by a parallel-fed transformer-coupled super-power valve which is capable of giving about $1\frac{1}{2}$ watts undistorted output. A set was "hooked-up" after the circuit diagram was devised, and it was found so successful that, after a few adjustments, it was installed as the latest set for home use.

The diode detector was found incapable of overloading and the full output of the set at perfect quality was obtainable on both local stations. The complete absence of any mains hum was noted, as well as improved selectivity due to low damping by the diode valve.

Station Switch

A switch for the locals is arranged to change from one to another as it was found that inexpert members of the family rarely tuned "dead" in to a station, so resulting in a loss of quality owing to the fairly sharp tuning obtained. The lay-

out does not appear too critical, and any good coils on hand can be used, either air or iron-cored being suitable. In the writer's case separate tuning condensers are used, but, of course, provided the coils are well matched, a dual-gang tuning condenser can be utilized. Owing to the excellent quality

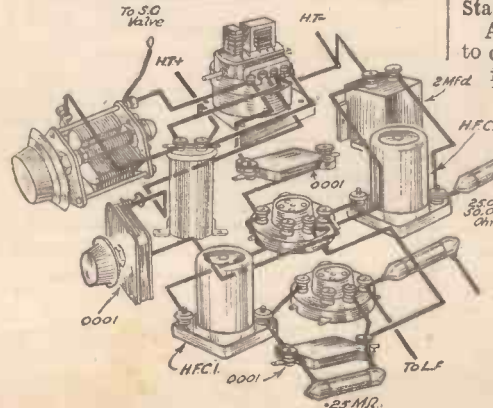
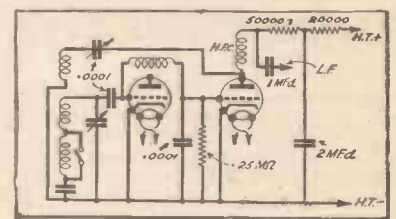
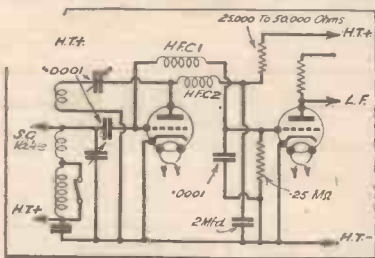

Fig. 2.—These circuits show the reaction and detector arrangements which were tried first.

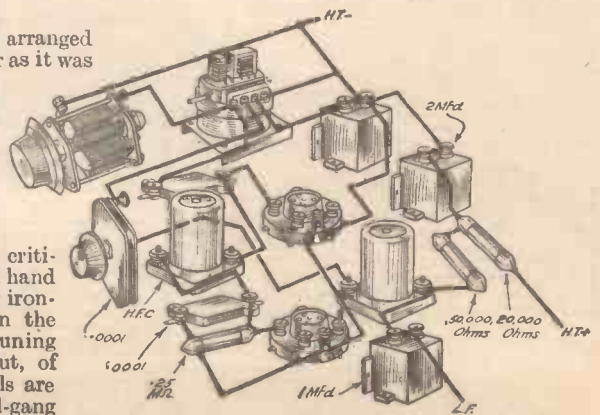

Fig. 3.—Another reaction system which is referred to in the text.

AN IDEAL RECEIVER FOR FAMILY USE—(Continued from previous page)

tion, but without effect, so far as increased range and volume on distant stations was concerned. Much experimenting was carried out in order to overcome this effect, but to no avail, and finally the scheme shown in Fig. 3, whereby reaction is obtained from the first L.F. valve, was tried.

With this circuit no reaction effects whatever were experienced, and after a little thought and experiment the circuit shown in Fig. 4 was devised. It will be found to be exactly the same as Fig. 3 with the addition of a neutralizing condenser in series with a push-pull switch across the H.F. choke which couples the diode and

performs its full function and is perfectly stable. With careful adjustment of the neutralizing condenser it can be made quite smooth. With this arrangement the set became very easy to handle, stations appearing all round the dial. Quality on foreigners as well as the locals was really superb.

There will probably be many objectors to the whole arrangement on the grounds of its unorthodoxy. To all such the writer would suggest a little experimenting with the circuit before finally condemning

Middleton, was appointed Librarian for the Chapter. A short talk was given by the owner and operator of the British Experimental Station G2HL. Members were asked to make a special note of stations heard on the 49-metre band during the next fortnight, and hand in their reports at the next meeting.—R. Lawton, Secretary, 10, Dalton Avenue, Thatch Leach Lane, Whitefield, Near Manchester.

THE CROYDON RADIO SOCIETY

PRACTICAL WIRELESS readers have already had a description of the Piezo-electric loud-speaker, and the Croydon Radio Society demonstrated it at the meeting on January 23rd, at St. Peter's Hall, S. Croydon, with Mr. F. Nightingale presiding. The demonstrator was Mr. G. H. F. Shanly, of R. A. Rothernel, Ltd., and he revealed the principle of the Piezo-electric speaker. Its crystal was specially prepared and had the property of flexing, or elongating across one diagonal when a current was applied at foil electrodes on opposite faces. Thus this movement was used for moving a cone, effected by a reed fixed at the free corner of the crystal and so to the cone's apex.

Mr. Shanly demonstrated his speaker on the Society's receiver, so that comparisons were made against the Club moving-coil speaker.

For the second part of the evening, Mr. H. V. Bothamley talked on, and demonstrated with, several loud-speakers.

This Society also had an interesting short-wave meeting on Tuesday, January 30th, at St. Peter's Hall. Many unique short-wave sets have been designed by members, but a five-valve superheterodyne was the star set of the evening. Its young owner was Mr. P. Bettridge. PRACTICAL WIRELESS readers are reminded that on Tuesday, February 20th, the President, Mr. H. R. Rivers-Moore, is retiring and a very interesting evening is expected.—Hon. Secretary, E. L. Cumbers, Maycourt, Campden Road, S. Croydon.

INTERNATIONAL SHORT-WAVE CLUB (LONDON CHAPTER)

An interesting demonstration of short-wave reception took place at the London Chapter meeting held on Friday, February 2nd, at the R.A.C.S. Hall, Wandsworth Road, S.W.8. Quite a wide range of short-wave receivers were demonstrated, among which was an A.C. short-wave converter constructed by Mr. G. Hayes. The following stations were heard on loud-speaker: VE9GW, Bowmanville, Canada, W3XL, W8XX, and the Empire stations at Daventry. Extraordinary reception was also obtained from JNL, Nagoya, Japan. To create interest in short waves we have installed an all-wave superhet on which short-wave reception will be demonstrated at each meeting.—A. E. Bear, Secretary, 10, St. Mary's Place, Botherhithe, London, S.E.16.

GOLDERS GREEN AND HENDON RADIO SCIENTIFIC SOCIETY

In response to an increasing interest shown by many radio amateurs in amateur cinematography, the Golders Green and Hendon Radio Society are forming an active subsection of this organisation to develop this increasingly interesting and absorbing hobby. A meeting will be held on March 1st at 8.15 p.m. at Hampstead Public Library, Finchley Road, when Mr. Percy Harris, F.A.C.I., M.I.R.E., will deal with the possibilities of amateur cinematographs, and Councillor Paul Storr will preside. A comprehensive programme of films taken by British amateurs will be shown. A demonstration of the new Piezo-electric loud-speaker will also be included. Tickets are free to readers of PRACTICAL WIRELESS.—President, H. Ashley Scarlett, 60, Pattison Road, London, N.W.2.

THE SIDCUP AND DISTRICT RADIO AND TELEVISION CLUB

"The Design and Construction of Loud-speakers" was the title of the very interesting lecture and demonstration given by Mr. B. B. Austin, of Messrs. British Blue-Spot Co., at a recent meeting of the Sidcup and District Radio and Television Club. Mr. Austin dealt very thoroughly with the subject of loud-speakers and, starting with the cone and suspension, he explained the many technicalities which had to be taken into account when designing each component of the loud-speaker assembly, not forgetting the importance of the output transformer. Full particulars of this Club can be obtained from the Hon. Secretary, Mr. W. F. Smith, 4, Rowley Avenue, Sidcup, Kent.

SMETHWICK WIRELESS SOCIETY

At the meeting of this Society, held at the New Talbot Inn on Friday, February 2nd, Mr. S. A. Stevens, B.Sc., delivered an interesting lecture on "Metal Rectifiers and Rectification." After explaining the nature of A.C., he stated that rectification could be regarded as a form of switching. He went on to describe the discovery, development, and manufacture of the copper oxide rectifier, and its use in mains eliminator circuits. The effects of reservoir condensers were also dealt with and some interesting oscillograms were shown to illustrate the particular points mentioned. The lecture was illustrated by an excellent series of lantern slides.—Hon. Sec., Mr. E. Fisher, 33, Freeth Street, Oldbury, Nr. Birmingham.

INTERNATIONAL DX'ERS ALLIANCE

Under the auspices of this Society a special short-wave transmission will take place as follows:—February 18th, 1934. 6 a.m. G.M.T. W8XO, 500 kw. This station will use WLW's frequency of 700 kc/s. Reports are requested by the I.D.A., Bloomington, Illinois, U.S.A., and by Crosley Radio Corporation, Cincinnati, Ohio, U.S.A.

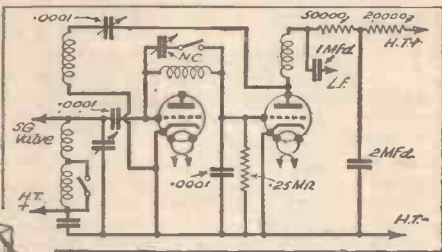
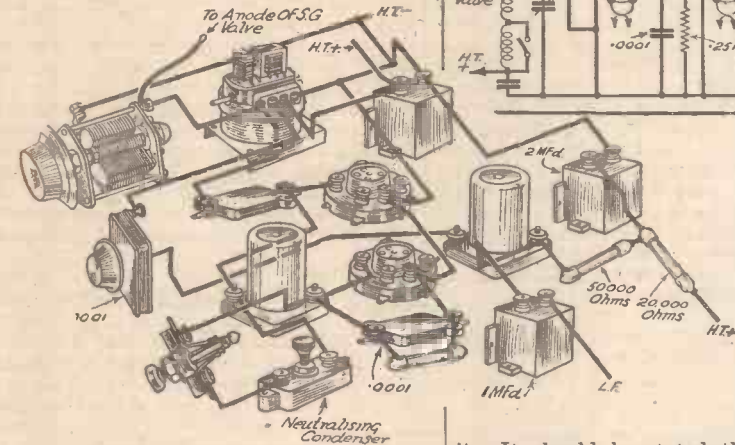

Fig. 4.—The final reaction arrangement which proved entirely satisfactory.



first L.F. valves. The switch serves the purpose of switching the neutralizing condenser in and out, and is the reaction on-off switch. The real object of interest is the neutralizing condenser. This is set to about half-way in, so feeding a little H.F. into the L.F. valve and permitting reaction effects to take place. Reaction

it. It should be stated that the circuit described was devised mainly for perfect reception of the locals, which it certainly gives. Reception of foreigners was a secondary consideration, but the set does actually bring in a dozen or so other stations at any time of the day at really good volume, and with far better quality than is usual.

RADIO CLUBS AND SOCIETIES

Club Reports should not exceed 200 words in length and should be received First Post each Monday morning for publication in the following week's issue.

CATFORD RADIO SOCIETY

By way of a change from the usual lectures on topics connected solely with radio, the members of the Catford Radio Society were entertained by a talk on the atom, given on Wednesday, January 17th, by its newly-acquired lady member, Miss Eldon. After a brief survey of the general properties of the atom, Miss Eldon went on to analyse the structure of the atoms constituting the commoner elements.

Miss Eldon illustrated her remarks by means of photographs and diagrams, and throughout revealed a grasp of a rather involved subject which held the undivided attention of an exclusively male audience. Hon. Secretary, H. W. Floyd, 38, Como Road, Forest Hill, S.E.23.

RADIO, PHYSICAL AND TELEVISION SOCIETY

At the meeting of this Society, held on January 26th, Mr. N. Partridge gave a lecture and demonstration on the transformer. The lecture included a brief historical résumé, including Faraday's discoveries, and finally led up to the modern transformer. Low frequency and output transformers were fully described, and also the difficulties associated with the design thereof. The programme for forthcoming meetings includes the following lectures: February 23rd, "X-Rays"—Lecture and Demonstration; March 9th, "Television"; March 23rd, "Electric Clocks"; April 6th, "Frequency Meters." Hon. Sec. F. J. Bubeare, 67, Nassau Road, Barnes, S.W.13.

COVENTRY SHORT-WAVE RADIO CLUB

A large gathering of local amateurs attended at the last meeting of the Coventry Short-Wave Radio Club, held at Stephens Memorial Hall on Tuesday, January 30th. This meeting marked a welcome return to the Club's old headquarters, and in future meetings

will be held every Tuesday at that address. During the evening the question of holding the Club's annual dinner came under discussion, and this will be held shortly. Local amateurs who would like to attend should get into touch with the Hon. Sec. The proposal that the Club's transmitter and receiver should be modernized was put forward and suggestions for the design was asked for. It is the hope of the committee that Television be brought into the Club's activities, and at the moment all developments in this line are being watched with keen interest.—Hon. Sec., C. Taylor, 28, Emerson Road, Coventry.

EXETER AND DISTRICT WIRELESS SOCIETY

The programme of this Society to the end of February is as follows:—

- 19th "Static. Its Causes and Neutralisation." By Mr. G. H. Bradley (G5QS).
- 26th "Fault Finding with Simple Apparatus." By Mr. F. J. Thorn.

THORNTON HEATH RADIO SOCIETY

A meeting of this Society was held on Tuesday, January 30th, at St. Paul's Hall, Norfolk Road. Mr. S. J. Meares presided. Mr. Alfred D. Gay (G6NF) gave a talk on the measurement of frequencies. He commenced by explaining the fundamental principles of alternating currents, and then applied those principles to the subject of his lecture. He then gave the formula for converting metres into frequencies. Later he illustrated with diagrams the elaborate equipment used for the exact measurement of frequencies and finally gave the circuit of the electron coupled oscillator which he himself had used with good results. Particulars of future meetings can be obtained on application to Mr. J. T. Webber, 363, Brigstock Road, Thornton Heath.

INTERNATIONAL SHORT-WAVE CLUB (MANCHESTER CHAPTER)

The third meeting of the newly-formed Chapter of the International Short-Wave Club in Manchester was held at 75, Long Street, Middleton, on January 23rd at 8 p.m. The necessary rules for the Chapter were made and passed, and in future meetings will be held every first Tuesday of the month, and will be open to all radio enthusiasts. Mr. H. Andrews, of

ANNOUNCEMENT

★ to men who want careers in RADIO



The I.C.S. Radio Courses cover every phase of radio work, from the requirements of the youth who wishes to make wireless engineering his career to the man who wants to construct and maintain a broadcasting set for his home.

The Radio industry is progressing with amazing rapidity. Only by knowing thoroughly the basic principles can pace be kept with it. Our instruction includes American broadcasting as well as British wireless practice. It is a modern education, covering every department of the industry.

OUR COURSES

Included in the I.C.S. range are Courses dealing with the Installing of radio sets and, in particular, with their Servicing, which to-day intimately concerns every wireless dealer and his employees. The Operating Course is vital to mastery of operating and transmitting.

There is also a Course for the Wireless Salesman. This, in addition to inculcating the art of salesmanship, provides that knowledge which enables the salesman to hold his own with the most technical of his customers.

We will be pleased to send you details of any or all of these subjects. Just fill in, and post the coupon, or write in any other way, stating which branch of Wireless interests you—the information you require will be forwarded at once.

International Correspondence Schools, Ltd.,
Dept. 94, International Buildings,
Kingsway, London, W.C.2

Without cost, or obligation, please send me full information about the Courses I have marked X

- COMPLETE RADIO
- RADIO SERVICING
- RADIO EQUIPMENT
- RADIO SERVICING AND SALESMANSHIP
- WIRELESS ENGINEERING
- WIRELESS OPERATORS

Name..... Age.....

Address.....

Smoothing Equipment on Non-Standard Frequencies

Practical Points to be Considered in Making Allowance for the Conversion of Supply Mains Which are Not Already on 50 Cycles

By P. E. BARNES

IT is now usual in published and commercial designs for A.C. Mains receivers to assume that they will be used on supply systems of the standard 50 cycles per second frequency, which the "Grid" is now making almost universal. There are, however, others in use, and, in particular, one of 40 cycles per second in a large area around Newcastle. Actually, in 1931, the following frequencies were in use in different parts of Great Britain: 25, 33, 40, 50, 60, 80, 87½, 90, 93, and 100 cycles per second; and although several of these have by now been converted to 50 cycles, some were in rural areas which have not yet been brought into line. It is for the benefit of those who live in such areas, or who are considering the building of receivers which are to be used there, that this article is written.

Transformer Requirements

The supply frequency affects both the transformers employed and the smoothing

—the greatest opposition is to lower frequencies, and the higher frequencies can pass more easily. A direct current, which is what we want, can pass the choke with only a small voltage drop due to the resistance, while it cannot pass the condensers at all.

The higher frequencies will have an easier path through the condensers, and will be more effectively rejected by the choke, and, conversely, the lower frequencies will have a relatively easy path through the choke (into the receiver), and will be less efficiently by-passed by the condensers. Thus, it is easy to realize that for the lower frequencies more smoothing will be needed than for the higher ones.

The "Safe" Rule

The "safe" rule is that for half the usual frequency, such as on a 25-cycle supply, twice the amount of smoothing is needed; for example, a choke of twice the inductance, and condensers of twice the capacity.

On a 40-cycle supply, where the difference is less important, it would probably be sufficient to increase the size of the condensers, and a change of choke would be unnecessary.

The above rule was termed the "safe" rule. That is to say, the smoothing given by it will be quite sufficient. In general, however, it is possible to obtain satisfactory results with less

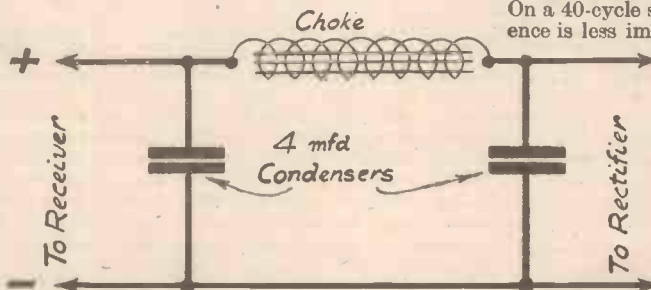

The smoothing circuit referred to in this article.

equipment. A transformer to be used on a lower frequency will need to be larger, or to have considerably more effective cooling arranged, or it will tend to overheat. It is advisable to obtain confirmation from the makers before using mains apparatus on lower frequencies than those for which they were designed. On a 40-cycle supply the effect will not, as a rule, be at all serious, and if free air circulation is allowed, no change is usually needed. The majority of mains transformers are rated as suitable for use on 40-100 cycle supplies.

In regard to the smoothing equipment, a little more attention is required, at any rate, on the lower frequencies such as 25 and 40 cycles, and in order to appreciate this, the functioning of the usual smoothing circuit arrangement must be understood.

The smoothing is effected by the combined action of a choke and two condensers, the former connected in one of the H.T. leads to the set, and the latter shunted across these leads, one on each side of the choke.

If we neglect the resistance of the choke, which should be relatively low in a good model, the impedance is proportional to the frequency, i.e., it offers most opposition to the higher frequencies.

The condensers have the opposite effect

smoothing than this, because the hum will be at a lower frequency, to which both the speaker and the ear are less sensitive.

The same problem occurs also in the case where a half-wave rectifier is in use. As far as the smoothing equipment is concerned, the effect is the same as if the set were in use on a 25-cycle supply, and it must be arranged accordingly.

Frequencies Above 50 Cycles

The problem of frequencies above 50 cycles is not a serious one, because a set which is adequately smoothed on 50 cycles will be even more effectively smoothed on 100 cycles.

In general, the correct course is to design the smoothing to function satisfactorily on the lowest frequency on which the receiver is to be used. It will then be found that it will give satisfactory results on the higher ones, and will not require any additions or alterations at a later date.

In purchasing or constructing new smoothing chokes for use on 25-cycle frequencies, it must be remembered that although the inductance must be higher, the D.C. resistance of the choke must not be appreciably raised, or a considerable voltage drop will result and the voltage on the valves will be less than the designed value.

Designing the High-Frequency Amplifier

Some Useful and Practical Notes in Regard to the Design of an H.F. Amplifier, Together with Helpful Information About the Choice of a Circuit and the Components.

It is well known that the chief object of an H.F. amplifier is to increase the range of reception, but it is not always realized that the amplifier performs another almost equally-important duty by considerably improving the selectivity of a receiver. When these two points are borne in mind it will be understood that a powerful H.F. amplifier is probably more valuable to-day than ever it was before. Selectivity is essential, and under the Lucerne Wavelength Plan the majority of the European broadcasting stations are sufficiently spaced in regard to their wavelengths that they will afford real entertainment provided that the receiver in use is selective and reasonably sensitive.

very few V.M. pentodes available for battery operation. He is therefore practically compelled to make use of one of the excellent "plain" variable-mu valves which are on the market in ample variety.

"Long" or "Short" Base?

The next point to consider is in regard to the "grid base" of the valve; shall it be "long" or "short"? The difference might be pointed out for the benefit of the less-experienced reader. A "short-base" variable-mu valve is one which requires a comparatively small variation in grid bias voltage to change it from its most sensitive to its least sensitive condition—in other words, to provide the necessary volume control. A "long-base" valve, on the other hand, calls for a wider range of grid-bias voltage. In the case of battery valves the choice rests very largely with the voltage of the G.B. battery to be used, but

intended for use in conjunction with a standard det.-L.F. kind of set. A single aerial coil is used and the choke in the anode circuit of the valve acts in conjunction with the .0002 mfd. fixed condenser to provide a coupling to the detector valve. The normal aerial coil of the receiver will thus complete the tuned-grid arrangement.

Important Points

The battery version will be considered first, and the principal points to note are the use of a fixed potentiometer for supplying the screening-grid voltage, the variable potentiometer for G.B. supply, and the use of a five-point on-off switch. Some of these items might be considered as unnecessary, so perhaps it will be best to explain them. A potentiometer supply for the screening-grid is always desirable, since it ensures that the correct voltage in proportion to the anode voltage is always applied. This is an important point in connection with variable-mu valves, with which it is important that the S.G. voltage should remain reasonably constant. The variable-mu potentiometer is standard, and should be of the "graded" type, the "tapered" end of the element being connected to the H.T. negative line. This connection is almost invariably brought out to the terminal which is on the left when the component is viewed from the front.

At first sight it would appear superfluous and unnecessarily complicated to use a five-point on-off switch, but this is the most convenient type, and a rotary or "barrel" switch is ideal when connected in the manner shown in Fig. 1. This point will be appreciated if various alternatives are tried out on a scrap of paper, and one example only will be given in explanation. Suppose, for instance, that the H.T. and L.T. negative leads were joined together. The high-tension circuit would be completed through the fixed potentiometer, by way of the valve filament and accumulator, so that a certain amount of current would constantly flow through this circuit. There are not very many five-point switches on the market, but it is quite convenient to employ a four-pole change-over of the type shown. As an alternative, it would be quite satisfactory to use a four-point push-pull switch by making one contact to the spindle; this can be done most conveniently by mounting the component on a metal bracket attached to a metallized chassis.

Component Values

Values are given to the principal components, but the resistances of R_1 and R_2 are not marked, since they depend largely upon the actual valve employed. In the majority of cases 50,000 ohms and 40,000 ohms respectively will be just about right, but the figures are generally given by the makers of the valve, in which case they should closely be adhered to. The high-frequency choke is an important component which has previously been dealt with on many occasions. It will be sufficient to say that this must be of the best possible type, having an inductance of not less than

(Continued overleaf)

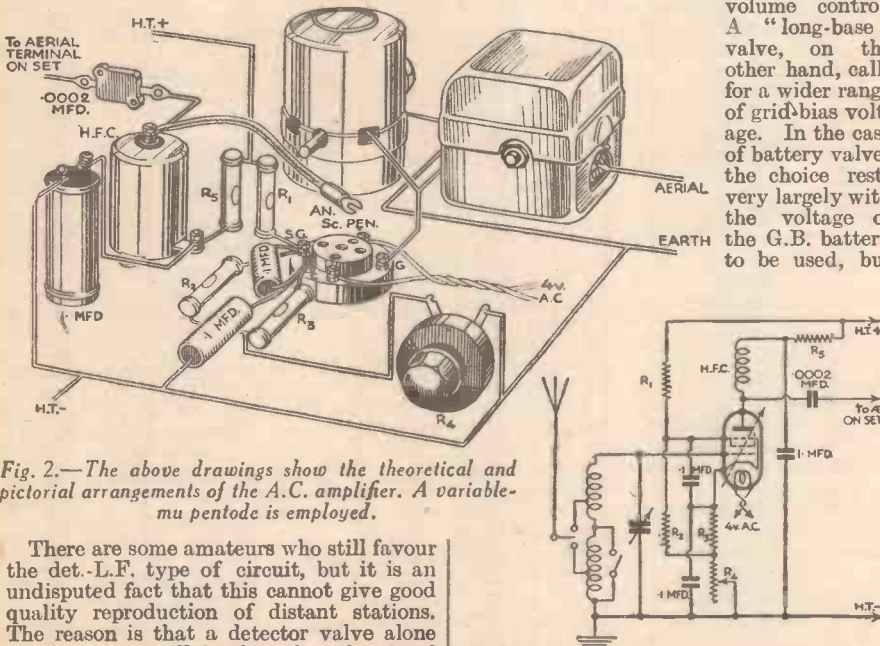

Fig. 2.—The above drawings show the theoretical and pictorial arrangements of the A.C. amplifier. A variable-mu pentode is employed.

There are some amateurs who still favour the det.-L.F. type of circuit, but it is an undisputed fact that this cannot give good quality reproduction of distant stations. The reason is that a detector valve alone cannot operate efficiently unless the signal voltages applied to it are in excess of a certain figure. Reaction is a great help, but even this is not a substitute for real high-frequency amplification, although it is a useful adjunct.

In the past it has been somewhat difficult for the average amateur to design an efficient and easily-operated H.F. amplifier, due to the fact that real stability and nicety of control were by no means easy to obtain. This is not the case now provided that the constructor is equipped with a knowledge of the fundamentals and is prepared to employ a modern valve in an up-to-date circuit arrangement.

Choosing the Valve

In designing the amplifier it is first of all necessary to decide upon the type of valve to be employed; after that the circuit can be built around it without any great difficulty. When the set is to be operated from the A.C. mains a variable-mu pentode cannot be improved upon, and this valve is somewhat more efficient and stable than an ordinary four-electrode variable-mu if correctly used. The battery user is not quite so fortunate, because there are

there is another important consideration. When it is proposed to employ automatic volume control in a set having only one (or even two) H.F. valve(s) the "short-base" type of valve is nearly always to be preferred since it is more sensitive to the comparatively small changes of A.V.C. voltage provided. On the other hand, when a manual volume control is to be employed, a somewhat "smoother" control of volume is possible by using a "long-base" valve. In the case of mains-operated valves the question of "long" or "short" does not usually enter into the matter of choosing the valve, because most types can be used in either way merely by altering their circuit arrangements—usually in such a way as to apply an appropriate voltage to the screening grid.

A Suitable Circuit

Before going any farther it will be most helpful to take an example of a fairly typical variable-mu H.F. amplifier; one for battery operation is shown in Fig. 1 and one for mains is given in Fig. 2. The two circuits are alike in principle and are



**CHOSEN
for the
A.C.
"FURY
SUPER"**

Again the exclusive choice was HEYBERD for Mr. F. J. Camm's A.C. Fury Super. Where quality and everlasting service were desired the inevitable selection was Heyberd. Ensure success by using the special Fury Super Transformer designed for this receiver. Ample supplies are available, and if you have the slightest difficulty in obtaining your model locally, write direct to us.

Model F.F. PRICE 24/-

I enclose 3d. in stamps for 36-pp. handbook showing how I can build my own Mains Unit, Battery Charger, etc., *Special Television Supplement in 3rd Edition just Published.*

Mr.

P.R.A.F

**F. C. HEYBERD & CO.,
10, Finsbury Street, London, E.C.2.**

**RA "MULTEX"
ALL-PURPOSE SPEAKER
MATCHES ANY SET**

The "MULTEX" Permanent Magnet, Moving Coil Speaker has been specially designed for use with all types of Receivers, commercial or home-constructed. It can be used in an original Speaker or an extension Speaker, matches the output of any Set, and will give you unequalled sensitivity, wonderful volume and glorious tone.



CHASSIS MODEL, Dia. 5ins. Depth 3 1/2ins. SEND ONLY 2/6 for 7 days' trial, if satisfied pay balance in 6 monthly instalments of 5/-. (Cash, in 7 days, 30/-).

CABINET MODEL in Walnut. Size 12 x 12 1/2 x 5 1/2. SEND ONLY 2/6, if satisfied pay further 2/6 at once, then 9 monthly payments of 5/- (Cash in 7 days, 45/-).

SEND ONLY **2/6** BALANCE MONTHLY



**E. J. HERAUD, Ltd. (Dept. P.46),
NUMBER ONE, EDMONTON, LONDON, N.18**
Phone: Tottenham 2256. Estab'd 34 Years.
Branches 78-82 Fore St., Edmonton; 77 West Green Rd., Tottenham; 34 St. James St., Walthamstow; and 139 Herford Rd., Enfield Wash.

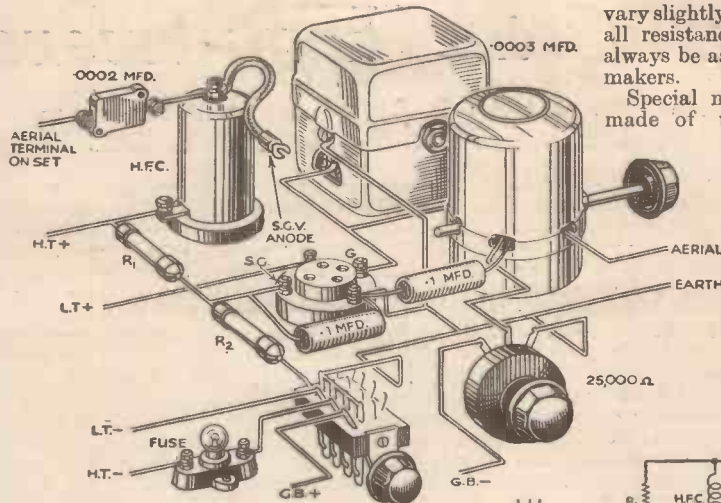

(Continued from previous page)

400,000 m.h. and a self-capacity not exceeding 3 m.mfd. The voltage of the G.B. battery will depend upon the grid-base of the valve, as previously explained. An amplifier made up according to the circuit in Fig. 1, and using an iron-core aerial coil with transfer-aerial tapping will prove to be extremely satisfactory in every way.

For Mains Working

The mains "edition" of Fig. 1 is given in Fig. 2, and is very similar in general principles, but employs a variable-mu pentode valve. The most important point to consider is that respecting the values of the various resistances marked R₁ to R₅; these values are always stated by the makers of the valve, but a brief explanation of their purposes will clarify the position. R₁ and R₂ obviously correspond with the similar components in Fig. 1, but their values will naturally be different. When using the valve as a "long-base" amplifier with a total H.T. voltage of 250, R₁ and R₂ should have values of approximately 20,000 ohms each, whilst if it is to be employed in a "short-base" arrangement, the resistances should have values of about 30,000 ohms and 15,000 ohms respectively. R₃ is the "minimum" bias resistance, its purpose being to apply the necessary bias when the volume control is set "full on"—a value of some 250 ohms is nearly always suitable. The variable bias, or volume control, is looked after by R₄, for which a "graded" potentiometer of 5,000 ohms will give the desired effect. It might seem that R₃ could be dispensed with, and in fact it could, but when the volume control was then turned towards its maximum position there would be a danger of the valve falling into oscillation and producing distortion. R₅ is for decoupling the anode circuit, and its value is not usually very critical, and a figure between 2,000 ohms and 15,000 ohms can be used. With most valves about 5,000 ohms is suitable for "long-base" working, and 12,000 ohms for "short-base."

Notice that the screening-grid potentiometer is returned to the lower end of the fixed-bias resistance and not directly to earth, as is more conventional. The reason for this is that the S.G. potential would be varied with the setting of the volume control if the potentiometer were connected directly to earth, and it must actually remain constant irrespective of the setting of the control. Different makes of valves

vary slightly, and that is why all resistance values should always be as specified by the makers.

Special mention must be made of the H.F. choke used in conjunction with the variable-mu pentode, because for the valve to give the maximum degree of amplification it is essential that the impedance in its anode circuit should be extremely

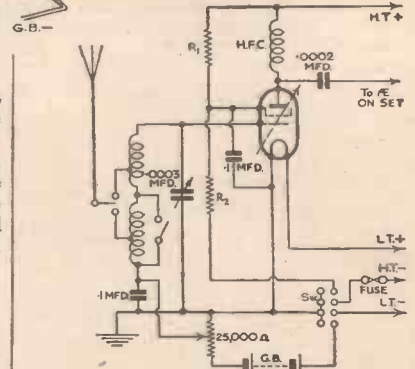

Fig. 1.—The battery-operated V.M. amplifier described.

high. For that reason it is often preferable to employ a choke of the superhet type having an inductance of 500,000 m.h. or so. Despite the high inductance, the choke must have a self-capacity of not more than 2 or 3 m.mfds., or else it will be less efficient than a component of even lower inductance.

Power Supply

The A.C. amplifier is intended to be operated from the same power supply as that provided for the receiver with which it is used. Consequently the H.T. and L.T. leads must be connected to the appropriate points in the set. This would not be a satisfactory arrangement, however, unless the mains transformer in use were capable of supplying 1 amp. (at 4 volts) more than the current taken by the heaters of the valves previously in use. Additionally, the output of the rectifier must be sufficient to permit of about 10 milliamps being supplied to the amplifier. In most cases these items will present no difficulty at all, but if the power supply unit of the receiver has no "reserve" it will be necessary to employ a separate unit for the amplifier.

There is really very little which requires to be said with regard to the actual construction of either of the amplifiers described. In both cases it is best to employ a metallized chassis, metallized valve, and screened coil, whilst the tuning condenser and H.F. choke should also be screened for preference.

In connecting either of the amplifiers to the receiver it is only necessary to transfer the aerial and earth leads from the set to the unit, and to connect the lead from the .002 mfd. fixed condenser to the aerial terminal on the set.

PRACTICAL LETTERS FROM READERS

The Editor does not necessarily agree with opinions expressed by his correspondents. All letters must be accompanied by the name and address of the sender (not necessarily for publication).

A Welsh Reader's Appreciation

SIR,—I have safely received the following gifts: Tool kit, "Wireless Constructor's Encyclopædia," and "Encyclopædia of Popular Mechanics." They are very useful, instructive, and interesting. I am a regular reader of PRACTICAL WIRELESS, "Practical Mechanics," and "Newnes' Practical Enquire Within," and I find them all very instructive and well illustrated, which I think is so important for amateurs like myself. I am eagerly looking forward to a "Practical Mechanics" all-mains wireless set.—A. PRITCHARD-WILLIAMS (Penygroes, N. Wales).

An Improved Input Transformer

SIR,—It sometimes happens that the input transformer of a moving-coil speaker burns out, or perhaps a cheap one is purchased, which has no input transformer. The latter was my own experience, but, having on hand a bell transformer, which had a 3, 5, and 8 volt secondary, I decided to try it as an input transformer to the moving coil. Using a pentode choke-capacity feed to the primary of the bell transformer (which was for 240 volts) results were splendid on the 8-volt tapping, and proportionately less on the other tapings. I might add the impedance of the speech coil was 7.5 ohms. I have also tried this method with several other moving coils, and in every case it has functioned satisfactorily.—L. MOON (Paddington, London, W.).

The First Popular Radio Journal

SIR,—To settle an argument, can you tell me who was the first journalist to edit a journal devoted to the amateur side of wireless?—U.K. (E.C.4).

[So far as we have been able to trace, the first journal to make a regular feature of amateur radio was Everyday Science, which regularly published a sixteen-page supplement devoted to wireless for amateurs. This magazine was edited by the present editor of PRACTICAL WIRELESS.]

Replies to Broadcast Queries: A Correction

SIR,—May I point out an error in a reply to a recent broadcast query in which you give the address of G6CW as Liverpool.

I very much doubt if the QRA of this station has been altered since Christmas, when the QRA was: J. J. Curnow, "Tregenha," Garrard Road, Banstead, Surrey. I am very interested in the Broadcast Queries column, as, of course, I sometimes find QRA's I want which are not in my present addition of the "Call Book."—L. H. SHERSBY (Radio G2GZ), London, S.E.

S.-W. Superhet Wanted

SIR,—I heartily agree with your correspondent "Leon" in your January 20th issue.

I have tried various short-wave circuits, and I have bought and made various coils, but I find that as an entertainment from a broadcasting point of view, short-wave work is not worth bothering about. As to picking up amateur morse, it is usually very slow and badly sent and so has no interest

for me. I am interested in short waves to provide me with foreign programmes, and if a set cannot do this it is of no use to me. Cannot we have a superhet for short waves, home-made as far as possible, a set which will entertain us, and one that will be interesting to make.—A. R. COOMBER (Chatham).

From a Satisfied South African Reader

SIR,—I have taken PRACTICAL WIRELESS from No. 1, Vol. 1, and have found it a very instructive paper. I am sure it is of great value to wireless enthusiasts in South Africa. Through the advertisements in this paper I have spent, in England, in the last twelve months, £67 10s., which, had I not received your paper, would never have been spent in that country. I would also like to express my gratitude for the consideration I have received from Messrs. Lissen, Ltd. Their prompt and careful attention to orders is greatly appreciated by people like myself, who have to wait two or three months after sending an order before receiving same, and it is with pleasure I have opened each parcel from Lissen, Ltd., to find my order properly executed.—E. W. WILKINSON (Kokstad, South Africa).

CUT THIS OUT EACH WEEK.

Do you know

- THAT a receiver may be tested when no broadcasting is taking place by means of a signal generator.
- THAT the above device consists of a simple reacting valve circuit, with, if necessary, a modulating valve circuit.
- THAT a special transformer, peaking at 375 cycles, is now obtainable for television synchronizing purposes.
- THAT the combined H.F. speaker and moving-coil unit recently described in these pages is now on the English market.
- THAT the working current of the television neon lamp is in the neighbourhood of 25 milliamperes.
- THAT the mirror-drum television receiver offers a black-and-white picture compared with the yellowish-red picture of the neon apparatus.
- THAT a new valve will shortly make its appearance on the English market with a nine-pin base.
- THAT a sample holder, which we have received for the above-mentioned valve, is no less than three inches in diameter.

NOTICE.

The Editor will be pleased to consider articles of a practical nature suitable for publication in PRACTICAL WIRELESS. Such articles should be written on one side of the paper only, and should contain the name and address of the sender. Whilst the Editor does not hold himself responsible for manuscripts, every effort will be made to return them if a stamped and addressed envelope is enclosed. All correspondence intended for the Editor should be addressed: The Editor, PRACTICAL WIRELESS, Geo. Newnes, Ltd., 8-11, Southampton Street, Strand, W.C.2.

Owing to the rapid progress in the design of wireless apparatus and to our efforts to keep our readers in touch with the latest developments, we give no warranty that apparatus described in our columns is not the subject of letters patent.

Newnes' New Monthly.
Practical Mechanics, 6d.
Modern Subjects in Everyday Language.
Lavishly illustrated. February issue now on Sale.



"We're Fluxite and Solder—the reliable pair; Famous for Soldering—known everywhere!"

The SET may look lovely—it may have cost much! To make SURE it is PERFECT—add this finishing touch!"

See that Fluxite and Solder are always by you—in the house—garage—workshop—anywhere where simple, speedy soldering is needed.

ALL MECHANICS WILL HAVE

FLUXITE

IT SIMPLIFIES ALL SOLDERING

All Ironmongers sell Fluxite in tins: 4d., 8d., 1s. 4d., and 1s. 8d. Ask to see the FLUXITE POCKET SOLDERING SET—complete with full instructions—7s. 6d. Ask also for our leaflet on HARDENING STEEL with Fluxite.

FLUXITE, LTD.
(Dept. W.P.), ROTHERHITHE, S.E.16.

FOR ALL REPAIRS!



"NAPS" No. 1—RESULT

- FIRST PRIZE, £100.**
Mr. B. Richmond, 80, Withnall Road, Blackpool, The Emerald Isle. "Land" Surrounded by "Hot Water."
- SECOND PRIZE, £50.**
Mr. K. W. Gordon, 111, Finchley Road, N.W.3. The Monster. "Gospel," According to St. Andrew!
- THIRD PRIZE, £25.**
Mrs. F. E. Palmer, 40, Oakwood Avenue, Southall. The Bride. More "On Her Shoulders." Later.
- FOURTH PRIZE, £20.**
Mr. T. S. C. Armsstrong, 21, Rawstons Road, Penwortham, Preston. The Monster. General Opinion A Huge "Gull."
- FIFTH PRIZE, £15.**
Mr. T. L. Allen, 42, Albert Road, West Bridgeford. The Torn Dress. Made Him "Nem"—Her, "Flounge."

- TWO PRIZES OF £10 EACH.**
Miss P. Howe, 17, East Street, Scar Lane, Golcar. A Scrap of Paper. Once "Certified" Europe's "Lunacy"
Mr. Charles Moss, 78, Fillebrook Road, Leytonstone. The Monster. A Really "Great" "Scot"!

- FOUR PRIZES OF £5 EACH.**
Mrs. E. Cox, 79, Mansfield Street, Sherwood, Notts. In the Emerald Isle "Tralee"—But Little "Trala"!
Mr. S. Halls, Lawn Cottage, Hockley, Essex. Peace and Prosperity. "Eloped" While "Guardians" Slept.
Mr. G. Stirrat, 28, Annick Road, Irvine. In The Fashion. Not "Shades" Of Our Grandmothers.
Mr. L. Wrigley, 148, Blacker Road, Birkby, Huddersfield. Red: Empire "Ripening"—Not "Dropping Off."

Whether your name appears in this list or not you will enjoy "Naps" in Tu-Bits.
Twenty Prizes of £2, Twenty Prizes of £1, 80 Prizes of 5s., and 160 Prizes of 2s. 6d., have also been awarded. Space will not permit the printing of these names in PRACTICAL WIRELESS, but a full list may be seen at 39, King Street, Covent Garden, W.C.2.

EASY PAYMENTS

"There's no place like HOLMES."

The first firm to supply Wireless parts on easy payments. Nine years advertiser in Wireless Press. Thousands of satisfied customers.

	Monthly Deposit.	Payments.
TELSEN Latest 323 Kit	29/6	4/- 7 of 4/1
Lissen Skyscraper 4	112/6	10/- 11 of 10/3
EXIDE H.T. Accum.,		
Y20V.	60/-	6/- 9 of 6/8
BLUE SPOT 29PM.	32/6	4/5 7 of 4/5
ATLAS ELIMINATOR,		
No. OA25	59/6	5/- 11 of 5/6
B.T.H. Pick-up	21/-	3/10 5 of 3/10
EPOCH 20th O. P.M.	35/-	4/10 7 of 4/10

Parts for any Kit Set. Any make of Speaker.
New Goods Obtained for Every Order.
 Send us a list of the parts you require and the payments that will suit your convenience, and we will send you a definite quotation. Anything Wireless.

H. W. HOLMES, 29, FOLEY STREET, Great Portland Street, London, W.1.

'Phone: Museum 1414.

FOR THE NEW WAVE-LENGTHS

THIS WAY CLEAR Reception

NO MORE MASTS OR WIRES!

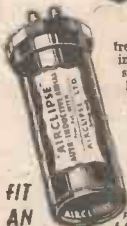

Use a selective aerial! Use an Airclipse. Get every station separately—free from mush, with reception amazingly improved by the Airclipse filtering incoming signals. Masts and wires are banished; lightning danger eliminated. Not another gadget—a new principle.

*Read this—from CANNES, South of France:—"The Airclipse has surprised me. It not only does away with outside aerials, but has cut out interference from Germany. I can now get London quite clear of all noises and interference, which in this part of the world are terrible."—J. S.

FIT AN

FOR B.E.M.A.S. BATTERY SETS

AIRCLIPSE 5! AUTO-INDUCTIVE AERIAL

With astonishing clarity and new selectivity, the Airclipse gives the efficiency of an outside aerial 60ft. high. Get an Airclipse yourself—and hear the difference.

AIRCLIPSE Ltd., 182, Vauxhall Bridge Rd. London, S.W.1.

WIRELESS AS A CAREER

This book tells you how to enter the Radio Industry as a Qualified Engineer

SEND THE COUPON FOR IT NOW

THE NATIONAL INSTITUTE OF RADIO ENGINEERING

TO THE NATIONAL INSTITUTE OF RADIO ENGINEERING

55-57 GUILDHALL STREET, PRESTON

Please send me free and post free a copy of "Wireless as a Career."

Name

Address

PRE

GET THE 'R.T.I.' 1934 HANDBOOK FREE

For particulars of Home-study Training in Radio, Television, and Talkies. We have courses from £2. No text-books used and every lesson full of interest. Recommendations given to Certificated Students.

RADIO TRAINING INSTITUTE of Gt. Brit., 85, New Oxford Street, London, W.C.1

FACTS & FIGURES



BY THE PRACTICAL WIRELESS TECHNICAL STAFF

NEW WEARITE TRANSFORMER

MESSRS. WRIGHT AND WEAIRE have produced a neat little transformer for use with the new Q.P. 21 valve, and the illustration below gives some idea of its size if the proportions between the terminals and the terminal strip are carefully noted. Actually, the height of the complete transformer is just over 2 1/2 in., whilst the core is only 1 in. thick. In spite of this small size, however, the transformer gives a very



The Wearite P.P.A. Transformer.

credible performance. The ratio is 9/1, and the D.C. resistance of the primary is only 400 ohms. The casing is finished in battleship grey cellulose, and the Wearite patent reversible feet are fitted so that the transformer may be mounted with the terminal strips at the top or at one side. The component is well up to the usual high standard of Wearite components and it costs 13s. 6d.

PETO-SCOTT H.F. UNIT

THE illustration on the right is a photograph of the new H.F. amplifier which has been produced by Messrs. Peto-Scott, and which is designed in such a manner that it may be connected to any existing receiver in order to improve range and selectivity. The entire unit is housed on a baseboard 7 in. square, and the panel is of a similar size. In addition to a standard .0005 mfd. tuning condenser of the slow-motion type, a special screened coil is employed. This covers both the broadcast wave-bands, a three-point switch being fitted to the panel for wave-change purposes. A separate on/off switch is also fitted to the panel for the filament circuit of the H.F. valve, so that this point has to be borne in mind when the unit is used in conjunction with an existing receiver. A separate H.T. feed is provided for the anode and screening grid voltages, and the negative lead is obtained through the existing receiver. Connection between the unit and receiver is obtained by a flexible lead which is, of course, connected to the aerial terminal on the receiver. The unit is obtainable as a complete kit containing every part down to the last screw in a sealed carton, and the price (exclusive of valve) is only 26s. This includes the aluminium screen which may be seen at the end of the baseboard, and which effectively prevents interaction between unit and receiver. The valve for the unit should be of the ordinary S.G. or H.F. pentode type, and the device will be found to be of great utility in bringing in those distant stations and giving a general improvement in selectivity and station separation.

speaker are easily accessible—the set can be tuned, and the entertainment can be heard without the necessity of removing the whole cover. The canvas cover is also fitted with a strong leather carrying handle, but at the sides apertures are made so that the set may be lifted by the handles fitted to the cabinet of the portable itself.

NEW EVER-READY H.T. BATTERY

A BATTERY specially designed for the Class "B" user has been introduced by the Ever-Ready Company. This battery was primarily designed for use with the G.E.C. superhet receiver which employs a Class "B" output stage, and, therefore, the condenser is of the type which will stand up to quite a good load. The rating of the battery is 140 volts, and tapings are provided at 4.5, 18, 31, 45, 72, 85, 99, 112, 126 and 140 volts. Included in the same case is a 9-volt grid-bias battery and this is of the standard type, tapped at every 1.5 volts. The overall dimensions of the battery are 9 1/2 in. by 7 3/4 in. by 3 1/2 in., and the price is 14s. The list number of the battery is W. 1250.

HIVAC DRIVER + B

THE unusual appearance of the combined driver and Class "B" valve which has been produced by the Hivac Valve Company, and which was recently referred to in these pages, has already been commented upon. In addition to the standard 7-pin valve base, a cap is provided on top of the valve, and the glass is shaped to retain the electrodes in rigid assembly by means of the popular mica spacer which bears against the glass shoulder. The electrodes are very compactly arranged and possess a most striking appearance, with the three filament suspension springs in the centre of the box-like assembly of anodes and other metal structures. The filaments are, of course, common to both driver and Class "B" sections, and thus only two pins are devoted to this part of the complete valve. The grids and anodes of the B section are taken to pins on the base, as is the driver grid. The anode of the driver section is connected to the cap on top of the valve, and this method of assembly makes it possible to try out one or two original schemes with the valve, and we have carried out some interesting experiments with the valve, which functions admirably in the manner intended. The price of the valve is

The new Peto Scott H.F. Unit.



15s. 6d., and the rating of the filament is 2 volts, 3 amps, and the anode to anode load of the Class "B" section is 14,500 ohms. It delivers a power output of 1 1/2 watts.

BELLING-LEE CATHODE RAY TERMINALS

EXPERIMENTERS who are using Cathode-ray tubes for various purposes will be interested to learn that Messrs. Belling and Lee are now able to supply their Type "B" terminals engraved with the letters GN, A1, A2, B1 and B2.

REPLIES TO BROADCAST QUERIES.

EDITOR'S NOTE: Querists must limit their queries to three per letter.

J. G. ASTON (Dublin): W9FAU, Willard Lindsay, RFD2, Payson, Illinois; CT1CD, Augusto B. Ramos, Castelo Bianco, Portugal; regret, cannot trace G5RA. M. U. D. (Tottenham): We can trace the following call signs: F3BU, 1, Pouget, Rossoul, Carmaux (Tarn), France; F3AB, J. Bordes, rue des Gigots, Loudun (Vienne), France; F3BM, Marcel Crette, 34, rue Marchais, Orleans (Loiret), France; F3CB, R. Breton, 45, rue des Amandiers, Paris (20e), France; F3DK, G. Bertholet, Route de Genève, Annemasse (Haute Savoie), France; F3BN, M. Mathias, 36, rue Marchais, Orleans (Loiret), France; F3BA, Wilford, rue d'Alsace, Biarritz, France; G6AF, R. Rice, 70, Seaside, Eastbourne; CT1JC, Claudino Diniz, Penafel, Portugal; ON4AG, A. Wust, 28, Avenue des Acaelias, Antwerp, Belgium; IACS and IASL, for particulars write: *Associazione Radiotecnica Italiana, Viale Bianca Maria 24, Milan, Italy*; W2DV, F. R. Colie, Woodcrest Ave., Milburn (New Jersey); W4PA, Anthierens, La Plnte-lez-Gand, Belgium; W2DW, E. Thompson, 107, Sussex Street, Peterson (New Jersey); G2AO, O. Reilly, "Gavinwood," Willington Road, Eastbourne; F8NR, René Gerret, 22, rue du Moulin, Lautenbach (Haut-Rhin), France; F8LP (R?) Etienne Leroux, 13, rue Orangerie, Algiers (North Africa); F8MR and F8ML, for particulars write: F. E. F., 17, rue Mayet, Paris (6e), France; F8SU (M?) P. Chapier, 36, rue des Cascades, Fontaine, d'Yvette, Villebon-sur-Yvette (Seine-et-Oise), France; F8DA (S?) F. Clouet, rue d'Alsace-Lorraine, Perreux-Oran, Algeria; F8PM (1?) C. Vigoureux, 3, rue Barcelone, Villeurbanne, Rhone; F8NO, C. Henck, 50, rue de la Forêt, Riedelsheim, near Mulhouse (H.-R.), France; G2IC, G. Chappann, 109, Cheriton Road, Folkestone; G2DF, F. A. Vost, 26, Pinewood Avenue, Warrington (Lancs); G5GS, W. Grievie, "Summerford" Station Road, New Waltham, Grimsby (Lincs); F8HF, A. Colle, 76, rue Henri Martin, Fargniers, France; G5HK, H. S. Beckett, 55, Mona Road, Crookes, Sheffield; G6HR, W. D. Keiller, 21, Newton Way, Cambridge Road, Upper Edmonton London, E.18; F8XM, Faure, 4, Villa du Pont de Grenelle, Paris, France; G6XF, C. Powell, 3, Monway Buildings, Holyhead Road, Wednesbury (Staffs); F8VU, Cie. Fabrication des Compteurs, 12, Place des Etas-Unis, Montrouge (Seine), France; G5UF, A. A. Barrett, 14, Cliff Avenue, Cromer (Norfolk); F8SK, R. Dort, 1, rue Delf, Bourdeaux (Gironde), France; F8PE, A. Acedot, 11, Cours Valatour, Lunel, (Herault), near Montpellier; F3DI, Cheney et Martin, 44, rue de Sèze, Lyon, France; F8AM, F. Munsch, 1, rue du Hugstein, Guebwiller (Haut Rhin), France; F3BC, Lucien Crabie, 90, Ave. Muret, Toulouse (H. G.), France; G2GJ, H. Jago, 189, Newport Road, Leyton, London, E.10; F8DS, Jean Lory, 38, rue Michel-Ange, Paris, France; F8AC, Lassort, Chemin du Port Boyer, Nantes (L.-I.), France; F8PL, H. J. Botello, Villa Marguerite, La Monte par Saint-Marcel, near Marseille, France; F3DG, R. David, 59, rue Caulaincourt, Paris (18e), France; F3DF, A. Sanson, 52, Grande Rue, Mer (Loire et Cher), France; F3CP, L. Regnier, 9, rue de Mazenay, Le Creusot (Seine et Loire), France; F8TR, R. Thibaut, 7, rue des Ecoles, Villeneuve-Saint-Georges (Seine et Oise), France; H. LEISHMAN (Shirlingtonshire); G6FR, A. F. Freeman, 2, Carpenters Road, Loddles, Birmingham; G6MZ, F. S. Mizen, 28, Brunel Road, Bridgewater Road, Bristol; G6HX, H. C. Kenworthy, 95, Waddon Park Avenue, Croydon (Surrey); G6NF, A. D. Gay, 49, Thornlaw Road, London, S.E.17; G6OA, F. E. Rogers, 16, Silversea Road, Westcliff-on-Sea (Essex); G6TF, W. Davidson, 12a, Erskine Street, Allon (N.B.); G6YU, J. Hanson, "Abbetdore," Wyken Avenue, Wyken Grange, Coventry; G5YB, R. C. Ashton, 41, Sithney Street, St. Budeaux, Plymouth; GML, F. W. Miles, Tudor Lodge, Gibbet Hill, Kenilworth (Warwickshire); G5SY, W. B. Sydenham, Sherrington, Cleveland Road, Torquay; G5NW, E. J. Allan, 3, Westfield Place, Dundee; G5GR, L. W. Gardner, 40, Medina Road, Coventry; G6SZ, J. W. Riddiough, Tranmere Park, Guiseley (Yorks); G2IG, R. H. Hammans, 119, Nelson Road, Gillingham (Kent); G2DL, R. H. Lauderdale, Kilwinning, Sutton Avenue, Horschurch (Essex); G2OZ, J. W. Norton, Daleside, Lincombe Drive, Torquay; G2GF, P. E. Griffiths, 12, Glencoe Mansions, Chapel Street, Brixton, S.W.9; G2YL, Miss N. Corry, Redholme, Walton-on-the-Hill (Surrey); PAOQA, T. C. van Braak, C245a, Varseveld, Guelderland, Holland; PAOKB, K. J. Asselberg, 8, Burgemeester Kerstenlaan, Breda, Holland; PAOAP, A. van Dokrum, 95b, Graaf Florisstraat, Rotterdam, Holland; PAOOPA, J. W. Wehkamp, Radio Centrale, 21, Markt, Coevorden, Holland; PAOOO, H. J. M. Kunnen, 27, Aalsterweg, Eindhoven, Holland; PAOPDA, D. Dekker, 88, Lange Delft, Middelburg, Holland; PAORO, J. R. Lettfré, 111, Scheveningschelaan, The Hague, Holland; G16WG, Robert Carlisle, 1, Portswewart Road, Portrush, Northern Ireland; for particulars regarding IRSL write: *Associazione Radiotecnica Italiana, 24, Viale Bianca Maria, Milan, Italy*; F8LA, A. Barba, 140, Avenue du Roule, Neuilly (Seine), France; F8WE, B. Taquet, Esqueherles (Aisne), France; F8SL, Granier, Faculté des Sciences, Besançon (Doubs) (France) ON4ZA, for particulars write:

Réseau Belge, 33, rue Alphonse Renard, Brussels Belgium; Cannot trace AF8KI, but if F8KI, M. Semennof, c/o Yvonne, 8, rue Desnouettes, Paris France; cannot trace call sign EA84DL; apparently mutilated; W3ABQ, E. N. McCullough, 36, North 56th Street, Philadelphia (Pa.). F. TAYLOR (Bournemouth): G5YK, G. W. Thomas, 169, Hills Road Cambridge; G5SY, W. B. Sydenham, Sherrington, Cleveland Road, Torquay; G5OG, C. I. Orr-Ewing, Pond Cottage, Weald, Sevenoaks (Kent); G5BY, Hilton L. O'Heffernan, 2, Chestow Road, Croydon (Surrey); G5MW, Medway Amateur Transmitter Society, 17, Tufton Road, Chatham (Kent); G5JO, L. Jones, Mella Loona, Leys Road, Cambridge; G5CV, P. D. Walters, 45, Fairfax Road, Bedford Park, London, W.4; G5YV, H. Beaumont, 58, Southhill Terrace, Crackenedge, Dewsbury (Yorks); G2KT, J. E. Nickless, Newsoula, Bull Lane, Rayleigh (Essex); G2IC, G. A. Chapman, 109, Cheriton Road, Folkestone; G2GF, P. E. Griffiths, 12, Glencoe Mansions, Chapel Street, Brixton, London, S.W.9; G2RJ, J. G. Runge, Kippington Court, Sevenoaks (Kent); G6PA, H. C. Page, Plumford Farm, Ospringe (Kent); G6RL, R. F. Loones, 14, Nursery Close, Wickham Road, Shirley, Croydon (Surrey); W2CO, J. T. Laird, 1,008, Sanford Avenue, Irvington, New Jersey; W8CPS, Robert R. Cope, 3,365, Beachwood Avenue, Cleveland Heights, Ohio; F8VP, M. Chambat, Chemist, Pont du Château (Puy-de-Dôme); F8PU, Bassus, 2, rue St. Vincent de Paul, Bordeaux, France; F8DN, M. Cheney et Martin, 44, rue du Sèze, Lyons, France; F8BI, Gaston Cassaigne, rue Sadi-Carnot, La Magistère (T. & G.), France; F8AM, R. Vallas, 3, Avenue de la Madeleine, La Varenne-St. Hilaire (Seine), France; F8LF, Lionne, Le Sambretton, Landreies (Nord), France; F8BL, Faucon, 20 rue d'Angouleme, Paris 11, France; F8CS, P. Sergent, 4, Avenue des Tournelles, Château (Seine et Oise), France; F8ZF, Eric Early, 119, rue d'Isly, Boulogne-sur-Mer, France; F8DW, Pierre Gilbert, Poulaines (Indre), France; ON4NC, C. J. Nolf, Château de Ramezgnies, par Thumalde (Hainaut), Belgium; PAOAZ, H. E. Jacobs, Graaf Florislaan 44, Hilversum, Holland; PAOPH, J. Philips, Obrechtstraat 39, Arnhem, Holland; PAOAP, A. van Dokrum, 95, Graaf Florisstraat, Rotterdam, Holland; PAOAG, R. H. Brouwer, Enterweg, Rijssen, Holland; PAOSD, I. Cohen, 119, Jozef Israelskade, Amsterdam, Holland; PAOEC, A. J. M. Rottier, 3, Hoofdstraat, St. Jansteen, Flushing, Holland; PAOLR, M. Smit, 64-1, Sluisstraat, Amsterdam, Holland; PAOOO, H. J. M. Kunnen, 27, Aalsterweg, Eindhoven, Holland; PAOAC, N. V. I. R., Post Box 400, Rotterdam, Holland; regret, but cannot trace call signs beginning "PN" for details regarding E12AFF, write: E14D, Ralph V. N. Sudler, "Lonsdale," Roebuck, Clonskeagh, Dublin. Call signs beginning with "R," belong to Russian amateurs, but regret cannot trace. MAO (Muswell Hill): we can trace the following call signs: G2CJ, S. Townsend, 115, Earham Road, Norwich; G6LE, J. H. Goodliffe, 97, Sheaf Gardens, Sheffield; F3BU, Irène Pouget, Rossoul, Carmaux (Tarn), France; F3BI, Marc Tonna, 134, Boulevard Dauphinot, Rhelms (Marne), France; F8PU, Bassus, 2, rue St. Vincent de Paul, Bordeaux, France; F8SB, P. Pilon, 21, Cours de l'Intendance, Bordeaux, France; F8AM, R. Vallas, 3, Avenue de la Madeleine, La Varenne St. Hilaire (Seine), France; F8VI, Manbes, 34, Av. de Verdun, Cauderan (Gironde), France; F8VL, M. Caradec, 177, rue Croix Nivert, Paris 15, France; F8BT, A. Spalart, 9, rue Caroly Mary, Hautmont (Nord), France; for untraced French calls write: *Réseau des Emetteurs Français, 17, rue Mayet, Paris (6), France*; for particulars regarding German call D4EFF, write: D. A. S. D., 19, Blumenthalstrasse, Berlin, W.57, Germany; and for Belgium calls, write: *Réseau Belge, 33, rue Alphonse Renard, Brussels 11, Belgium*; for Italian calls write: *Associazione Radiotecnica Italiana, 24, Viale Bianca, Milan, Italy*; SP1AS, cannot trace, write: P. Z. K., 6, Bielowskiego, Warsaw, Poland; W2NZ, Milton D. Delson, 315, West 106th Street, New York City. ARNOLD MOSS (Huddersfield): G5QY, H. C. D. Hornsby, 7, Lansdowne Terrace, Gosforth, Newcastle-on-Tyne; G5PQ, W. F. Moore, 17, Lawn Road, Uxbridge (Mdx.); G6PL, F. J. Poppelwell, "Hollinbank," White Lee, Heckmondwike (Yorks); G6PY, L. W. Parry, 13, Huddersfield Road, Barnsley (Yorks); G6KO, J. B. Sturrock, Kirkbuddo, Forfar, Scotland; G2HL, T. Wolstenholme, Chesham Post Office, Bury (Lancs).

PROVIDENCE COTTAGE (Misterton): W1XAZ, short-wave relay of WBZ, Springfield (Mass.) on 31.35 m. This station belongs to the N.B.C. System. MAO (Muswell Hill): G2KV, J. K. Todd, Orchard Place, Wannock, Polegate (Sussex); G2CJ, S. Townsend, 115, Earham Road, Norwich; G2IC, G. A. Chapman, 109, Cheriton Road, Folkestone; G2XS, H. W. Sadler, "Redways," Wootton Road, Gaywood, Kings Lynn; G2RJ, J. C. Runge, Kippington Court, Sevenoaks (Kent); G2JU, P. J. Pearcey, Collinwood, 126, Pinner View, Harrow (Mdx.); G5AR, G. W. Hale, 1, Bijou Villas, Grand Drive, Raynes Park, S.W.20; G5OG, C. I. Orr-Ewing, Pond Cottage, Weald, Sevenoaks; G5SY, W. B. Sydenham, Sherrington, Cleveland Road, Torquay; G5AR, E. D. Ostermeyer, 59, Gordon Road, Woodford, E.18; G5CB, Captain K. Hartridge, 2, Westbourne Crescent News, W.2; G5GZ, G. L. Grisdale, 39, Ranelagh Gardens, Ilford; G5MR, V. G. Mellor, Sele House, Hertford (Herts); G6VJ, Royal Naval College, Dartmouth (Devon); G6VG, J. Rainey, 9, Hartington Street, Belfast; G6PN, P. R. Painton, Clifton, Brampton Grove, Hendon,

(Continued on page 1038)



BOOSTER UNIT
Mains-power volume from your H.T. BATTERY!

The Booster Unit enables super-power valves to be employed with an actual saving of H.T. current.

If your Receiver is extravagant of H.T. current follow the lead of eminent designers, fit a Booster—and get mains-power volume from your normal H.T. Battery. A type for all Receivers, 7/6. Write for leaflet B.P.2 to Sole Manufacturers.

GRAHAM FARISH, LTD., MASONS HILL, BROMLEY, KENT.

7/6

A GRAHAM FARISH PRODUCT

PIX
INVISIBLE AERIAL

AN INSIDE AERIAL THAT'S AS GOOD AS AN OUTSIDE AERIAL—

AT THE SAME HEIGHT



2/-

DOUBLE LENGTH 3/6

PRESS IT AND IT STICKS ANYWHERE

A revolutionary idea in aeriels. You just unroll it and press it up in position around the room or anywhere you like. No danger whatever from lightning, reduces static interference — increases selectivity. Obtainable anywhere.

BRITISH PIX CO., LTD., LONDON, S.E.1 THE BEST AERIAL FOR FLATS

TONASTAT

SOLVES THE QUESTION

OF INCREASING SELECTIVITY WITHOUT APPRECIABLE LOSS OF SIGNAL STRENGTH, AND OF REDUCING VARIOUS FORMS OF INTERFERENCE

"Practical Wireless" says:

"We tested this device with a number of circuits, and found it functioned admirably."
 "... It will not be found difficult to find a setting which will give not only a great improvement in selectivity, but which will, also, in cases where interference is experienced, reduce that nuisance without appreciably interfering with signal strength."

TONAX WILL SOLVE YOUR NEW WAVELENGTH TROUBLES

Simple to use. Easy to connect. A circuit to suit your set is shown on instruction leaflet "A" supplied with every "Tonastat."

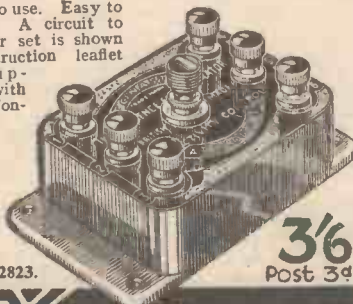

Phone: Enfield 2823.

3/6 Post 3d

7X PRODUCTS CO

32, QUEENSWAY, PONDERS END, MDDLX.

EASY TERMS PROMPT DELIVERY

Any Amplion, Blue Spot, Baker, Celestion, Epoch, R. & A., Rola, Sonochorde, Grampian, Igranic, Lamplugh, Magnavoix, Ormond, W.B., or Ferranti Moving Coil Speaker Supplied.

Send 5/- only

and pay the balance by monthly instalments. No references. Entirely private and confidential.

KITS, PARTS, SETS, ELECTRIC CLOCKS ON EASY TERMS.

Send for list of 83 Speakers, and state requirements.

TURNADGE AND PARTNERS, LTD.

Ludgate House, Fleet St., London, E.C.4. Telephone: Central 1903.

END H.T. WORRIES

ONCE AND FOR ALL



Any voltage supplied.

Thousands of listeners have proved the Standard Leclanche Battery a paying proposition. Gives abundant pure current, year in, year out, at half cost of dry batteries. Does away with constant replacements and poor results. Always up to voltage; regathers power when not in use. Annual replenishment all that is necessary. C. L. W., of Lewisham, writes: "Bought battery 4 years ago, well satisfied with low cost and dead silent power", 120-v. 12.500 m.a., £2 complete, carriage paid. Write for details of this money-saving permanent H.T.

ALL STANDARD BATTERY SPARES SUPPLIED.

THE WELL-KNOWN

WATES METER 4 in 1
 The ideal testing instrument, gives 4 readings - 0-30 m.a., 0-180-v., 0-6-v., 0-15-v., 8/6 post free. Accurate, invaluable. Wates Glass Accumulator, 2-v. 40 amp. hrs., 7/-.



THE WET H.T. BATTERY CO. (Pr.), Gerrard 6121. 26, Lisle Street, London, W.C.2.

PATENTS AND TRADE MARKS.

KING'S PATENT AGENCY, LTD., 146b, Qn Victoria Street, E.C.4, offer "Advice Handbook" and Consultations free. 49 years' references. Write, call or phone. Phone: City 6161. Director, B. T. King, O.L.M.E. Reg. Patent Agent, U.S.A. and Canada.

REPLIES TO BROADCAST QUERIES

(Continued from page 1037)

N.W.4; G6RF, C. Quinn, 44, Emerson Road, Coventry; G6OM, I. Auchterlonie, The Gables, Gayton, Heswal, Birkenhead; F8RT, Armand, Spalart, 9 bis, Rue Caroly-Mary, Hautmont (Nord), France; F8SO, Schultz, 9, Rue André Schaff, Sarreguemines (Moselle), France; F8JS, Maurice P. Schaar, Solignac (Haute-Vienne), France; F8CS, P. Sergent, 4, Avenue des Tourelles, Château (Seine et Oise), France; F8DS, Jean Lory, 38, Rue Michel-Ange, Paris, France; F8NR, René Gerrer, 22, Rue du Moulin, Lautenbach, Haut-Rhin, France; F8QL, P. Coulon, Bulles (Oise), France; PAOGO, J. Doeseema, 36, Wilgstraat, The Hague, Holland; PAOJK, J. Stufkens, Blois van Trelsonstraat, 47, The Hague, Holland; PAOIK, I. J. Kligen, Ryswykscheweg, 213, The Hague, Holland; PAOAH, T. Stap, Oudhildtjij (Frie zand), Holland; PAOAR, write: N.V.I.R. Post Box 400, Rotterdam, Holland; For particulars regarding Belgian calls, ONAZA and ONARR, write: Réseau Belge, 33, rue Aphonse Renard, Brussels, Belgium. CTIIP, Adriano de Mesquita, 11, rua Nova de Santa Cruz, Braga, Portugal. H. K. HARDY (Newbury): (1) All Dutch call signs must begin with PAO; apparently you heard PAONB, H. W. van Ven, Stationkade 115, Amsterdam 111, Holland; (2) GMBI is the call of S.S. Empress of Britain (there is no call sign GMBK); works on several wavelengths including 17.05 m., 22.88 m., 33.95 m., and 71.82 m.; (3) F8WV (N?), Gilbert Picard, Branne (Gironde), France; (4) F8JV, Société Française Radio-Électrique, 79, Boulevard Haussmann, Paris, France; (5) F3FL, address not published, write to: Réseau des Émetteurs Français, 17, rue Mayet, Paris, France; (6) F8TE, André Madelin, 32, Allée du Busca, Toulouse, France; (7) W9LD5, call sign mutilated; possibly W9LDY, William E. Moulic, Jr., 511, Vale Street, Bloomington, Illinois; (8) W3ZK, M. L. Kann, 2,452, Callow Avenue, Baltimore, U.S.A.; (9) Regret, but cannot trace W2GOQ; (10) WIBNM, E. W. Lincoln, 215, Lincoln Avenue, North Dighton, Mass.; (11) VE2HK, Dr. Owen Stredder, 3,419, Beaconsfield Avenue, Montreal (Quebec); (12) WIHPM, J. Brodie Smith, 25, North Street, Manchester (New Hampshire); (13) W9JV, Norbert W. Knoernschld, 3,288, North 30th Street, Milwaukee; (14) apparently Rugby testing on new channel; regret, cannot say which; (15) There are several Lawrenceville (N.J.) and Rocky Point (N.Y.), channels just above 20 m. Possibly WQV, Rocky Point (N.Y.) on 14,800 kc/s; (16) F8PE, given as the call sign of; Albert Acedot, 11, Cours Valatour, Luner (Near Montpeller), France; (17) Regret, cannot trace. R. S. HOUGHTON (Wigan): We believe this to be CTIGL, Radio Parede (Portugal). SUPERBET (Merioneth): (a) possibly WFEA, Manchester (New Hampshire), 209.8 m., which has been heard in the British Isles; (c) apparently Odessa (U.S.S.R.) 449.8 m., but cannot confirm; (b and d) details too vague.

DUNCAN D. DONALDSON (Leven): (1) No, not WFFZee, but WSB, Atlanta (Ga.), N.B.C. station on 405.2 m.; (2) XRR, Villa Acuna (Coahuila, Mexico), on 407.9 m.; (3) CRCM, Montreal (Que.), 329.5 m. This station belongs to the Canadian Radio Broadcasting Commission. Interfered with by LRE, Radio Patria (Buenos Aires), on 330 m. H. K. HARDY (Newbury): (1) F8ZL given as call sign of amateur transmitter: A. Brugger, 37, Rue Cluseret, Suresnes (Seine), France; (2) F8VP, M. Chamhat, Chemist, Pont du Château (Puy-de-Dôme), France; (3) Regret, cannot trace; (4) F8FZ, N. Barbusse, Comps (Gard), France; (5) FMSAW, Charles Marchal, Avenue de Maubeuge, Mustapha Sr., Algeria; (6) Possibly EAR4AN (formerly EAR02), comde de Vilana, 15, Paseo de Santa, Engracia, Madrid, Spain; (7) If EAR4AH, Luis San Juan, 14, Rios Rosas, Madrid, Spain; (8) F8CS, L. Sallio, 16, Rue Cordière, St. Brieuc, Côtes du Nord, France; (9) F8RM given as R. Brissand, 5, Boulevard Louis Prade, Marseilles-St. Joseph, France; (10) F8FA, P. C. Pellerin, Route de Barentin, Malaunay (Seine Inférieure), France; (11) F8WV, M. Petipas, 42, Avenue de Paris, Soissons (Aisne), France; (12) F8WV, G. Picard, Branne (Gironde), France; (13) F8KV, M. Goud, "Les Banpres", Choresy par Beaune (Côte d'Or), France; (14) Regret, cannot trace; (15) WICW, Clarence E. Winsor, 217, Alston Street, Cambridge, Mass.; (16) WICHI, Wardwell F. Holman, 34, Williams Street, Arlington, Mass.; (17) W3VX, Ch. H. Jenkins, 617, 3rd Avenue, Audubon, New Jersey; (18) CGA2, Drummondville (Que.), 9,330 kc/s; (19) possibly WOO, Ocean Gate (N.J.), 4,750 kc/s; works with ships. Regret, cannot confirm; (20) Regret cannot trace. J. W. MASON (Conisbrough): W3XAU, Philadelphia (Pa.), 31.28 and 40.50 metres. VEIBV, C. S. Taylor, Stewiacke, Nova Scotia; VEIEA, Clarence E. Roch, Box 384, Windsor, Nova Scotia; VE2BU, R. D. Huestis, 61, Stratford Road, Hampstead (Province of Quebec); WIWV, M. W. Weeks, 40, Norfolk Road, Chestnut Hill, P.O., Brookline, Mass.; W8JK, John D. Kraus, Arlington Boulevard, Ann Arbor, Michigan; G6UF, E. J. Finn, "Rafcen", Wash-on-Deane, Rotherham, Yorks; BR3, 1,330 (Misterton); HJLABB, Barranquilla (Col.), 6,447 kc/s; PSK, Marapiue (Rio de Janeiro), 8,185 kc/s; HA72, Budapest (Hungary), 6,840 kc/s; EAQ, Madrid (Spain), 10,000 kc/s; LCL, Jely, (Norway), 6,090 kc/s; DJC, Zeesen (Germany), 6,020 kc/s; W3XAU, Philadelphia (Pa.), 6,057 and 6,585 kc/s. WET PAINT (Gateshead): G6AY, amateur transmitter: A. Hembury, 6, Rosewood Gardens, Sheriff Hill, Gateshead, Durham.

Be SAFE! SPECIFY



TRANSFORMERS & METERS

Moving Iron Meters (D.C. only) - Type E66 - Semi-flush - 2 1/2 in. overall - from 7/-

SIFAM TRANSFORMERS

- Accurately layer-wound
- Acid-free Paper interleaving
- High-grade Bakelite Bobbins
- Low-loss Silicon Iron
- Tapped Primaries

Whatever your transformer or meter needs, specify "Sifam". Sifam have long been famous for the quality of their materials and workmanship and the accuracy of their components. The "Sifam" range covers every possible need - though either transformers or meters can be made to your own specification if necessary. Write for full details of complete range to -

SIFAM

ELECTRICAL INSTRUMENT Co. Ltd. York Works, Browning Street, London, S.E.17.

Telephone - - - Rodney 3573

OSBORN CABINETS

5/- to £10.

Catalogue containing

37

DESIGNS

with amazing Osborn Box Baffle post free.

CHAS. A. OSBORN, Regent Works, Arlington Street, New North Road, Islington, London, N.1.



ENGINEERS! ARE YOU EARNING LESS THAN £10 PER WEEK?

If so, you cannot afford to carry on without reading our 256-page Handbook. The book explains clearly and definitely many ways of carving out a successful career. Among other things, it explains the Services of our unique Appointments Department, outlines Home-Study Courses in all branches of Civil, Mechanical, Electrical, Motor, Aero, Wireless, "Talkie," Eng. Building, etc., and gives details of B.Sc., A.M.I.C.E., I.E.E., A.M.I.Mech.E., A.M.I.A.E., G.P.O., MATRIC, and all Exams. We alone Guarantee - "NO PASS - NO FEE." Whether you be an old hand or a budding apprentice, get this book to-day - FREE and POST FREE.



BRITISH INSTITUTE OF ENGINEERING TECHNOLOGY, 390 Shakespeare House, 29/31, Oxford St., London W.1.

RADIO SUPPLIES

Send your list of Radio needs for our quotation. Kits, Parts, Sets, etc. Everything in Radio stocked, prompt delivery. 7 days' approval. Catalogue free. Taylor & Standard Wet H.T. replacements stocked. N. TAYLOR, 9, GROVE RD., BALHAM, S.W.12

LET OUR TECHNICAL STAFF SOLVE YOUR PROBLEMS

REPLIES TO



If a postal reply is desired, a stamped addressed envelope must be enclosed. Every query and drawing which is sent must bear the name and address of the sender. Send your queries to the Editor, PRACTICAL WIRELESS, Geo. Newnes, Ltd., 8-11, Southampton St., Strand, London, W.C.2.

QUERIES and ENQUIRIES by Our Technical Staff

The coupon on this page must be attached to every query.

SPECIAL NOTE.

We wish to draw the reader's attention to the fact that the Queries Service is intended only for the solution of problems or difficulties arising from the construction of receivers described in our pages, from articles appearing in our pages, or on general wireless matters. We regret that we cannot, for obvious reasons—

- (1) Supply circuit diagrams of complete multi-valve receivers.
 - (2) Suggest alterations or modifications of receivers described in our contemporaries.
 - (3) Suggest alterations or modifications to commercial receivers.
 - (4) Answer queries over the telephone.
- Please note also that all sketches and drawings which are sent to us should bear the name and address of the sender.

LONG PICK-UP LEADS

As you will see from the attached sketch my set employs the popular S.G., detector and L.F. circuit, with no switch in the grid circuit of the detector for radio or gramophone purposes. The cabinet is rather out of the ordinary, and the lead from the pick-up to the grid, which is on the control panel, is over 2ft. long. I cannot make it any shorter, and the set has to be placed low in the cabinet. Naturally, when using the set on radio there is instability due to the long lead. I have too many controls already on the panel, so do not want to fit a change-over switch. Can I stop this loss and trouble in any way? —G. T. (Worcester).

The only suggestion we can make in your case is to fit a good H.F. choke between the pick-up lead and the grid of the detector valve. The choke should be placed as close to the valve as possible, and should be of the screened type, with the screen earthed to avoid interaction with any other part of the circuit. The principal features of the choke should be high inductance and very low self-capacity, and we think you will find that this will remove your trouble.

USING AN OLD MAINS TRANSFORMER

I am rebuilding my old commercial receiver, and the mains transformer which is fitted was designed for a 7.5 volt 2.5 amp. rectifier. The H.T. winding and the heater windings are quite suitable for my new circuit, but I wish to use one of the modern rectifying valves as the old one is practically exhausted. Can you tell me how to modify the original winding without damaging the transformer? —B. D. (Gloucester).

There is no need to attempt to alter the winding, as it is possible to use one-half for the purpose of heating the rectifier. The modern rectifier takes 4 volts at 1 amp, and the original heater winding was no doubt centre-tapped, thus permitting one half to be used to deliver 3.5 volts at the required current. The H.T. positive tapping may be taken from one end of the winding, as the centre tap is not really necessary with modern receivers.

P.A. MIXING SYSTEMS

I am building a small Public Address outfit, using the power amplifier recently described in your issue. I wish to employ a gramophone pick-up for playing records, with a microphone for making announcements. I understand that a switch which breaks the grid circuit of a high-power valve is bad, and I know it also results in clicks or bangs every time it is opened. How would you advise me to rig up the mike and pick-up so that I can change from one to the other easily without trouble? —W. S. E. (Bristol).

There are several schemes available, the simplest being to use a potentiometer across the pick-up and a similar device across the secondary of the mike transformer. The arm of the pick-up potentiometer is joined to the grid of the first valve, and the lower end of this potentiometer is joined to the arm of the mike potentiometer. The lower end of this potentiometer is then earthed or joined to the grid-bias tapping. The two potentiometers may then be adjusted to mix either circuit, or to use either pick-up or mike

separately. The grid and earth line of the above arrangement may alternatively be joined across the primary of a further transformer if it is desired to carry out more accurate matching of impedances, but complications will then be introduced in order to correctly ascertain the various loads imposed when the potentiometers are separately adjusted, especially if they vary in their values. It is preferable, in the first instance, to use potentiometers which match the pick-up and mike impedances.

A PECULIAR FAULT?

I have built your Orbit receiver, but must confess that I am completely baffled in my efforts to make it work. I can get absolutely nothing from it, not even a squeal when the reaction control is operated. The valves have been tested by my dealer and are up to standard, and I have tested all components with meters, etc., and every test has been passed. The wiring has been checked by two friends and announced O.K., and the speaker works on another set. Can you possibly explain why I can get no signals? —J. O. I. R. (Cardiff).

There must obviously be something wrong if you can get no signals of any sort, and this points to one of your tests being faulty. Obviously, if all components are O.K. and wiring is correct, something should be received, and we would therefore imagine that you have

AUTOMATIC-BIASING ARRANGEMENT

I am fitting an automatic biasing circuit to my mains set, but as I am uncertain regarding the actual load on the rectifying valve I am deciding to fit a variable adjustment. I enclose the circuit, from which you will see that I propose to fit a potentiometer in the negative lead, and I am not sure where to put the by-pass condenser. Can you please sketch it in for me? —Y. A. (Bournemouth).

The circuit as you have drawn it is incorrect. The valve is indirectly heated, and therefore you should include the biasing resistance in the cathode lead in the usual manner. The lower end of the transformer should be joined to earth via a high resistance, say, 50,000 ohms or so, and the end of the transformer should be connected to a fixed condenser joined to the cathode direct. In order to avoid risk of removing the bias entirely, the potentiometer should be half the value which you give, and the remaining half should be made up in the form of a fixed resistance, so that this will be in circuit at the minimum setting of your variable control. You must remember that a power valve may be damaged if the bias is completely removed whilst it is working.

H.F. IN L.F. LEADS

I have had a new speaker given to me and I wish to use this in another room in the house. I find, however, that as soon as this extra speaker is connected I have to go down the dial just over four degrees in order to get the station. This seems to occur on all stations, and if I use any reaction the set has to be readjusted as soon as the extra speaker is joined up. Can you tell me how to cure this? —C. E. W. (Macclesfield).

This is a certain indication that H.F. is getting into your output leads, and we should imagine that you have not fitted an output filter. This, as we have repeatedly stressed in these pages, consists of a choke in the anode circuit of the last valve, and a condenser between anode and the speaker leads, one of which is earthed. However, if you have such a device and still suffer from the trouble—due to a poor quality choke, for instance, an H.F. choke should be joined between the anode and the speaker lead, with a condenser between anode and earth. The condenser value may not be critical, and a value of about .01 will probably be found most suitable.

CLASS B TRANSFORMER

I have tried out the Q.P.-P. arrangement which was described some time ago, but now wish to try the Class B circuit. Is it possible to use the driver transformer and the output choke which I have with the Class B valves? —T. Y. (Rotherham).

The original Q.P.-P. circuit did not utilize a driver transformer, but a transformer having a step-up ratio of about 8 to 1. The Class B circuit requires a certain power to be delivered to the output valve, and thus a step-down is required, usually of the order of 1 or 1.5 to 1. You cannot, therefore, use your old transformer. With regard to the choke, the load is approximately the same, although it will depend largely upon the loud-speaker which you are using. You should consult the valve-maker's instruction sheet and use the correct value in conjunction with your existing speaker.

PROBLEM No. 71

Re your Problem No. 71, I would point out that I sent you a correct solution of same, but have heard no more from you. In this week's issue you state that two readers only sent in correct solutions, but this is not true, as stated, my solution was also correct. I should like your remarks on same. —L. R. (London, E.1).

With regard to our Problem Competition, we would point out that all entries have to be received by Monday morning first post, after which they are all mixed and opened at random. It would therefore seem that your entry was received late. We do not, obviously, keep a note of all entries, and as the letters are destroyed we cannot enter into any correspondence regarding this competition.

DATA SHEET No. 74
Cut this out each week and paste it in a notebook.

STANDARD METAL RECTIFIERS

Type	Maximum smoothed D.C. output		Max. Current output mA.	Maximum A.C. Input		Price
	Volts	mA.		Half Wave Volts	V. Doubler mA.	
H.T.5	120	20	30	135	30	80 12/6
H.T.6	175	25	30	210	40	110 75 15/-
H.T.7	200	28	30	250	45	135 90 17/6
H.T.8	250	60	60	375	90	200 200 18/6
H.T.9	300	60	60	—	—	240 200 21/-
H.T.10	200	100	100	250	150	150 300 21/-
H.T.11	500	120	150	—	—	300 550 35/-
H.T.12	200	30	40	250	80	140 120 17/6
H.T.13	150	25	40	175	40	— 17/6

overlooked some little point in your checking, or the method which you have adopted for testing components is not an accurate one. For instance, how have you tested the resistances? Checking for continuity will not indicate the value of the resistance, and there may be one of these which is practically a dead short, a point which would only be indicated if you used a voltage and a meter in series in order to test the current passed. Again, in wiring, you may have a short to some component. You should, therefore, take a current reading in each anode circuit, and also take the total anode current reading (in the H.T. negative lead) to test for a short-circuit of the H.T. supply through the metal covering of the chassis, for instance.

RECORDING MORSE

Can you tell me how to build a simple device to make a permanent record of Morse signals? I cannot yet read the code quickly, and would like to make records of various stations to check my own readings: I do not want it to be too elaborate, but something to join to my broadcasting receiver. —K.E. (Welwyn).

All that is necessary is a relay, with an inked point, and a roll of paper (or a long strip) which is drawn along at a constant speed below the point. An ordinary buzzer may be converted by fitting a thin glass tube at one end of the armature, and drawing the tube to a point. This should be filled with ink. A small clockwork motor or similar apparatus should be arranged so that two small rollers grip the strip of paper and draw it beneath the inked point, and the buzzer should then be joined to the output terminals of the receiver. The record will be made on the paper in dots and dashes. A suitable design is given in "The Wireless Constructor's Encyclopaedia."

FREE ADVICE BUREAU COUPON

This coupon is available until February 24th, 1934, and must be attached to all letters containing queries.
PRACTICAL WIRELESS, 17/2/34.

Miscellaneous Advertisements

Advertisements are accepted for these columns at the rate of 3d. per word prepaid—minimum charge 3/-—and must reach this office not later than Tuesday for the following week's issue. All communications should be addressed to the Advertisement Manager, "Practical Wireless," 8 Southampton Street, Strand, London.

PREMIER SUPPLY STORES

offer the following Set Manufacturers' Surplus New Goods at a fraction of the original cost; all goods guaranteed perfect: carriage paid over 5/- under 5/- postage 6d. extra (Ireland, carriage forward).

PREMIER SUPPLY STORES announce the purchase of the entire stock of a world-famous Continental valve manufacturer. All the following types of standard mains valves at 4/6 each. H. H. L. Power. Directly heated 6-watt Pentode. Directly heated 9-watt Pentode. High magnification Screen-grid, low magnification Screen-grid, Variable-Mu Screen-grid. 250 volt 60 milliam. full-wave rectifiers.

THE following types 5/6 each. Indirectly-heated Pentode. 12 watt output Triode (P.X.4 Type). 350 volt 120 milliam. full-wave Rectifier. 500 v. 120 ditto, 6/6; Dario Battery Valves 4v. filament. Set of 3, consisting of Screen-grid, Detector and Power or Super-Power, 6/6 the lot. Power or Super-Power, 2/6. ELIMINATOR Kits, including transformer, choke, Westinghouse metal rectifier, T.C.C. condensers, resistances and diagram, 120v. 20 m.a., 20/-; trickle charger 8/- extra; 150v. 30 milliamps, with 4v. 2-4 amps. C.T. L.T., 25/-, trickle charger 6/6 extra; 250v. 60 milliamps, with 4v. 3-5 amps. C.T. L.T., 30/-; 300v. 60 m.a., with 4 volts 3-5 amps. C.T. L.T., 37/6; 150 volts 50 milliamps, 27/6.

AMERICAN Triple Gang 0.0005 Condensers, with trimmers, 4/11; Premier chokes, 25 milliamps, 20 Henries, 2/9; 40 milliamps, 25 hys., 4/-; 65 milliamps, 30 hys., 6/-; 150 milliamps, 30 hys., 10/6; 60 milliamps, 80 hys., 2,500 ohms, 5/6.

HARLEY Pick-up, complete with arm and volume control, 12/6.

BRITISH RADIOPHONE Wire Wound Potentiometers, with mains switch incorporated, 10,000 ohms, 3/6.

PREMIER British-made Meters, moving iron, flush mounting, accurate, 0-10, 0-15, 0-50, 0-100, 0-250 m.a., 0-1, 0-5 amps.; all at 6/.

SPECIAL Offer of Mains Transformers, manufactured by Philips, input 100-120v. or 200-250v., output 160-0-180 volts 40 m.a., 4v. 1 amp., 4v. 3 amp., 4/6; 200-0-200v., 4v. 1a., 4v. 3a., 4/6.

ALL Premier Guaranteed Mains Transformers have Engraved Terminal Strips, with terminal connections, input 200-250v. 40-100 cycles, all windings paper interleaved.

PREMIER H.T.3 Transformers, 250v. 60 m.a., rectified with 4v. 3-5a. and 4v. 1a. C.T. L.T., screen primary, 15/-; with Westinghouse rectifier, 25/-.

4 V. 3a. C.T., 6v. 2a. C.T., 9v. 1a., 12v. 1a., 17/6 each; 4v. 3-5a., 22v. 1a., 8/6 each; 10v. 3a., 4/6 each, 10/- each.

PREMIER H.T.9 Transformer 200v. 60 m.a., with 4v. 3-5a. and 4v. 1a. C.T., L.T., and screened primary, 15/-; with Westinghouse rectifier, 26/-.

PREMIER H.T.10 Transformer, 200v. 100 m.a., rectified, with 4v. 3-5a. and 4v. 1a. C.T., L.T., and screened primary, 15/-; with Westinghouse rectifier, 26/-.

PREMIER Mains Transformers, output 135v. 80 m.a. for voltage doubling, 8/6; 4v. 3-4a., C.T., L.T., 2/- extra; Westinghouse rectifier for above, giving 200v. 30 m.a., 8/6.

PREMIER Mains Transformers, output 250-0-250v. 60m.a., 4v. 3-5a., 4v. 2-3a., 4v. 1-2a. (all C.T.); with screened primary, 15/-.

PREMIER Mains Transformers, output 350-0-350v. 90m.a., 4v. 3-5a., 4v. 2-3a., 4v. 1-2a. (all C.T.), with screened primary, 15/-.

PREMIER Mains Transformers, output 400-0-400v. 100 m.a., 4v. 4-5a., 4v. 2-3a., with screened primary, 15/-.

PREMIER Auto Transformers, 100-110/200-250v., or vice versa, 100-watt, 10/-.

MULTI Ratio Output Transformers, 4/6, Twin Screened Wire 3d. per yard.

CENTRALAB Potentiometers, 50,000, 250,000 half meg., any value, 2/-; 200 and 400 ohms, 1/-.

RELIABLE Canned Coils with Circuit, accurately matched, dual range, 3/- per coil; ditto iron core, 3/6.

PREMIER L.T. Supply Units, consisting of Premier Transformer and Westinghouse rectifier, input 200-250v. A.C. output, 2v. 1amp., 11/-; 8v. 1amp., 14/6; 8v. 1amp., 17/6; 15v. 1 amp., 19/-; 8v. 2 amp., 27/6; 30v. 1 amp., 37/6.

MAGNAVOX D.C. 152, 2,500 ohms, 17/6; D.C.154, 2,500 ohms, 12/6; D.C.152 Magna, 2,500 ohms, 37/6, all complete with humbucking coils; please state whether power or pentode required; A.C. conversion kit for above types, 10/-; Magnavox P.M., 7in. cone, 18/6.

GRAMPION M.C. Loud Speakers, 2,500 ohm field, 9in. cone, handles 5 watts; 21/-.

(Continued at top of column three)

ELECTRADIX



No. 11, 5/6



No. 12B 18/6



No. PW 11, 10/6



1,000 other bargains in our new Sale List N. Send stamped addressed envelope.

ELECTRADIX RADIOS, 218, UPPER THAMES STREET, E.C.4. Telephone: CENTRAL 4611

NO INTEREST

GRAMPIAN, MOVING-COIL SPEAKERS.

ALL complete with Multi-Ratio (including "Class B") Transformers.

GRAMPIAN.

Deposit. Monthly. P.C.5 .. 27/6 5/- 5 at 4/7

GRAMPIAN.

B/P.C.1 .. 35/- 5/- 6 at 5/- Free Baffle Box with this unit.

GRAMPIAN.

"Owl" Dual 55/- 6/- 10 at 4/11

GRAMPIAN.

EXTENSION 37/6 4/- 7 at 4/10 Cabinet Speakers.

GRAMPIAN.

Any Combination of Dual, also Energised Speakers in all Resistances.

THAMES VALLEY MANUFACTURING CO., Station Avenue, Kew Gardens.

NEW LIFE FOR YOUR SET

Your aerial is robbing you if it's old and corroded. Try a new and better one; try SUPREMAC at our expense. Sling up a shorter length, compare results. You'll get better reception all round or we'll refund your money.

100 ft. 75 ft. 50 ft. 25 ft. 3/6 2/6 1/9 1/-

From Dealers Everywhere.

The New London Electron Works, Ltd., 6, East Ham, E.6.

(Continued from column one)

GRAMPION P.M. Loud-speakers, 9in. cone, handles 4 watts; 18/6.

ELLIOT First-grade Moving-coil Motors, 0-30, 0-50, 0-100, 0-150 ma., projecting types, 15/- each; 0-100 0-150 m.a. flush types, 17/6 each.

B.T.H. Truesped Induction Type (A.C. only) Electric Gramophone Motors, 100-250v.; 30/- complete. Type YH 100/250v. A.C. or D.C., 42/-.

WESTERN ELECTRIC Condensers, 250v. working, 1 mfd. 6d., 2mfd., 1/-; 2mfd. 400v., 1/6.

SPECIAL Offer of Wire Wound Resistances, 4 watts, any value up to 10,000 ohms, 1/-; 8 watts, any value up to 15,000 ohms, 1/6; 15 watts, any value up to 50,000 ohms, 2/-; 25 watts, any value up to 50,000 ohms, 2/6.

POLAR 3-gang 0.0005, with complete disc drive, split end vanes, and trimmers, 8/6; Polar 2-gang, with complete disc drive, padding condenser and trimmer, 0.0005, 6/6.

COLLARO Electric Gramophone Motor, complete with all fittings, turntable and automatic stop, 100-250v. A.C.; 35/-, listed 43.

EDISON BELL Double Spring Gramophone Motors, complete with turntable and all fittings, a really sound job 15/-.

AMPLION Cone Loud-speaker Units, 1/9, complete with 12in. cone and chassis, 3/11 each. Worth trouble.

ROUND Condensers, 0.0005 2-gang, semi-shielded, 2/6; brass vanes, with trimmers, 3/6.

WIRE Wound Potentiometers, 15,000 ohms, 1/6; 50,000 ohms, 2/-; 500,000 ohms, 3/-.

HOME Radio Microphone, complete, 5/-; simply plug in to pick-up terminals.

LARGE Selection of Pedestal, table and radio-gram cabinets, by best manufacturers, at a fraction of original cost for callers.

WESTERN ELECTRIC Mains Transformers, 500-0-500v. 150 m.a., 4v. 3-5a., 4v. 2-3a., 4v. 2-3a., 4v. 1a. C.T., 4v. 1a. C.T., 19/6.

1,000 OHM 150 m.a. Wire Wound Variable Resistance, 2/-; Burnsted 2-watt resistances, all values from 0.5 to 50 ohms, 3d. each; holders, 2d. each.

T.C.C. Condensers, 250v. working, 1 mf., 1/3; 2 mf., 1/9; 4 mf., 450v. working, 4/-; 750v. working, 2 mf., 3/-; 4 mf., 6/-.

T.C.C. Electrolytic Condensers, 440 volts working, 4 mf. or 8 mf., 3/-; 15 mf. 50v. working, and 50 mf. 12v. working, 1/-; 25 mf. 25v. working, 1/3.

T.C.C. Block Condensers, 250v. working, 4 x 4 x 1 x 1 x 0.5, 3/6; 2 x 2 x 2 x 0.1, 2/-; 2 x 2 x 2 x 1, 2/3; 2 x 2 x 1 x 1 x 1 x 1 x 0.1 x 0.1, 3/-; the above three condensers at same price by Dubilier 300v. working.

H.M.V. Block Condensers, 400v. working; 4 x 4 x 1 x 1 x 1 x 1 x 0.1 x 0.1 x 0.1, 6/-; 4 x 2 x 1 x 1 x 1 x 0.5, 4/6.

DUBILIER Condensers, 2 mf. 1,200v. working, 4/-; 4 x 4 x 2,300v. working, 3/-; 8 mfd. dry electrolytic, 450v. working, 3/-; 0.01 mica, 1,000v. working, 1/-.

THE Following Lines 6d. each, or 5/- per dozen.—Chassis valve holders, 5, 6 or 7 Pin, screened screen-grid leads, any value 1-watt wire end resistances, wire end condensers, 0.0001 to 0.1, R.I. .0005 varicaps, trimming condensers, T.C.C. 6md. 50v. electrolytics.

PLEASE mention PRACTICAL WIRELESS when ordering.

PREMIER SUPPLY STORES

20-22, High Street, Clapham, S.W.4, MACaulay 2188. Closed 1 o'clock Wednesdays; open to 9 o'clock Saturdays. Nearest Station, Clapham North, Underground.

THE following valves are guaranteed unused and perfect, and any valve differing from the makers' characteristics will be exchanged; and all latest types. A.C./Pens, P.T.4s, A.C.S.G./V.M.s, Pen. 4v, M.V.S.G.s, D.P./Pens, A.C.S.2/Pens, M.M.4v.s, P.T.625s, V.M.S.4s, D.C.2/Pens, D.P.T.s, P.M.24M.s, M.P.T.4s, V.M.4V.s, A.C.S.1/V.M.s, P.M.24A.s, D.C.2.S.G.V.M.s, S.P.4s, 11/-; M.S.4s, M.S.4Bs, A.C.S.2s, S.4V.A.s, S.4V.B.s, M.S.G./L.A.s, D.S.B.s, A.C.S.2s, D.C.2S.G.s, 9/6. "Class B": P.M.2 B, P.D.220, 220 B, 8/6, M.L.4s, A.C.P.s, P.M.24s, 8/-; A.C./H.L.s, 164V.s, 354V.s, A.C.2/H.L.s, 41M.H.L.s, U.10s, U.U.60/250s, M.H.4s, M.H.L.4s, 7/6; V.S.2s, 215S.G.s, 220S.G.s, P.M.12s, 9/-; 442B.U.s, D.W.3s, 8/6; 215P.s, 220P.s, L.P.s, 5/-; P.I.T.2s, P.M.22A.s, 9/-; H.L.210s, H.210s, L.210s, L.2s, 4/-.

ALL types of Brand New American Valves in Stock, first-class makes: 247s, 235s, 224s, 236s, 237s, 233s, 18's, 15's, 59's, 58's, 89's, 238s, 239s, 244s, 12/-; 227s, 226s, 245s, 280s, 9/6; 242s, 232s, 11/-; U.X.250s, 281s, 17/6. Dubilier or Erie resistors 1 watt type, 7d. Westinghouse rectifiers unused H.T.S, 10/-; H.T.9, H.T.10, 11/3. Dubilier or T.C.C. electrolytic condensers 8 M.F.D., 3/9. Magnavox, D.C. 152 (2,500 ohms) or 6,500 ohms, 9in. cone, 25/-.

Superhet Radiopacs 12/12/6. "Clydesdale" Eliminators, unused, D.C. 12/6. A.C. (Westinghouse) 25/-.

Carriage Paid. Cash with Order or c.o.d.—Ward, 45, Farringdon St., E.C.1. Holborn 9703.

RAD-AUTO-GRAM buy Modern Second-Hand Components for Cash.—39, Tulketh St., Southport.

WANTED good Modern Wireless Parts, Sets, Eliminators, Meters, Valves, Speakers, etc. Spot Cash waiting. Send or bring. We pay more than any other dealer. Open 9-8.—University Radio, 142, Drummond St., Hampstead Rd., N.W.1.

SOUTHERN RADIO'S Bargains.—Set manufacturer's guaranteed surplus.

VARIABLE Condensers.—Lotus 3-gang 0.0005, 12/6; Lotus 2-gang, 0.0005, 8/6; Lotus Dyblock single, 0.0005, 4/0 (list 9/6); all these condensers are complete with dials, escutcheons, knobs, fully screened with trimmers, and boxed: Igranik variable, 0.0003 and 0.0005, 2/3; Hydra block condensers, 16 mfd. (2+2+8+2+1+1), 1,000 v. D.C., 7/- each; 20 mfd. (2+2+2+2+2+2+2+1+1+1+1), 1,500 v. D.C. with terminals, 11/6; Dubilier 4 mfd. (2+1+1), 1,000 v. D.C., 2/9; 4.5 mfd. (2.25+2.25), 3/-; fixed 4 mfd., 2/3; 2 mfd., 1/6; 1 mfd., 1/-.

SPEAKERS.—Blue Spot permanent magnet, with universal transformer for power, pentode, super power or class B, 23/- (list 39/6); D.C. mains energised, all voltages, 16/6; Celestion Soundex P.P.M. permanent magnet, 17/6 (list 27/6); Blue Spot 100U inductor, complete with chassis, 13/6 (list 39/6); Celestion permanent magnet type P.P.M.W. universal transformer, 25/- (list 49/6).

BLUE Spot, 66K, complete in cabinet, 16/- (list 42/6); G.E.C. Stork, in magnificent cabinet, 19/6 (list 33/15); all speakers new in original cartons.
PICK-UPS.—B.T.H. Senior 1934 model, with volume control, 23/6 (list 37/6); Blue Spot, model "88", with volume control, 26/- (list 63/-); Marconi No. 19 (1934), 26/- (list 32/6).

CONSTRUCTORS' Kits.—Ready Radio Meteor "A" 3-valve screened grid kits, with cabinet and moving coil speaker, less valves, £3/7/6; with valves, £4/10 (list £3/7/6); Ready Radio S.T.400 kits, all specified components, by Scott Tuggart, £2/19/6 (list £4/17/6).

FRAME Aerials.—Lewcos dual wave 235-550 metres F and 1,000-2,000 metres, 10/- each (list 37/6); Igranik "Igranipak" complete tuning units, A.C. and D.C. types, 29/6 each (list 57/6).

MISCELLANEOUS.—Ferrocart coils, G.1, G.2, G.3, with switch, 31/9 (list 39/6); Igranik Super screened coils, set of 4, 12/6 (list 50/-); Benjamin Class "B" transformers, tapped, 1 1/2 to 1 and 1 to 1, 6/6 (list 10/6); Benjamin Class "B" universal output chokes, 9/6 (list 11/-); Ready Radio Instamat Universal transformers, for matching any value to speaker, 11/6 (list 37/6); Rotorohm and Radiophone volume controls, all values, 3/- each; with switch, 3/3 (list 10/6); S.T.500 coils, 5/6 per pair; Hellesen's 8 mfd. electrolytic condensers, 2/9 each; Westinghouse metal rectifiers, H.T. 6, 7, 8, 9/3 each; Ampion loud-speaker units, 2/3; Ferranti choke, 20 henry 60 m.a., 6/9 each; Kolster Brandes gramophone motors, dual, for A.C. or clockwork, complete with turntable and all accessories, 110-250 volts, 25/- each (list 63/-); Ready Radio L.F. transformers, 5-1, 3-1, 3/3 (list 8/6); B.T.H. transformers, 3/6; Lewcos superhet 8-way bases, complete with valve holders, grid leak, fixed condenser, type "48", 2/- each.

MAINS Transformers and Chokes.—Please send for complete list; specials can be supplied within 3 days of order.

ALL Transformers and Chokes Guaranteed for 12 months.

ALL Goods Guaranteed and Sent Carriage Paid.

BRANCHES at 271-275, High Rd., Willesden Green, N.W.10, and at 46, Lisle St., W.C.2; please send all post orders to 323, Euston Rd., N.W.1.

SOUTHERN RADIO, 323, Euston Rd., London, S.W.1 (near Warren St. Tube). Phone: Museum 6324.

RADIO CABINETS. 50 designs, 25% less than cost. Single Cabinets sold to callers.—Stenbic Ltd., 303, Essex Road, Islington.

TELEVISION Illustrated Constructors' Handbook, 1/-. Apparatus Lists Free.—Bennett Television, Redstone Copse, Redhill.

REPAIRS—REWINDING—OVERHAULS. Loud speakers, 4/-; Blue Spots, 5/-; New cones fitted to Moving Coil speakers, 6/-; Eliminators, Mains transformers, etc., quoted for. Special components and sets made to order. Quick service. Laboratory tested. Repair Dept. C., Weedon Power Link Radio Co., 80, Lonsdale Avenue, East Ham, London, E.6. Phone Grangewood 1837.

BIRMINGHAM RADIOMARTS February list now ready, included ironcored bandpass kits, ditto packs, mains equipment, valves, short-wave gear, etc., all by renowned makers and guaranteed new and perfect. Hundreds of items 1934 goods, not junk. Send 1/4d. stamp. **THE SQUARE DEALERS, 19, JOHN BRIGHT STREET, BIRMINGHAM.**

NEW and Secondhand Sets; kits and parts bought, sold, exchanged. Best exchange allowances. Balance to pay on new sets payable on easy terms. Brand new Class B driver transformers and output chokes, 5s. 11d. each, post free; C.W.O., or C.O.D.—R. Wigfield, Furlong Road, Goldthorpe, Yorks.

THE 'RADIO GOLD-MINE.' The indispensable guide to all surplus and liquidation stocks.

L.E.C. CLASS B BARGAINS.—Drivers, Output chokes 4/6. V-holders 6d. Conversion kit with full instructions 10/8. Valve 9/-.

L.E.C. SPEAKER BARGAINS.—Special Offer P.M.M.C. 14/11. Cone units 2/6.

L.E.C. COIL BARGAINS.—Dual Range. Special line 1/-. Screened Iron cored 4/3. Screened ordinary 2/6.

THE 'RADIO GOLD-MINE' for quality goods at the lowest liquidation prices ever!

L.E.C. VARIABLE CONDENSER BARGAINS.—0.0003 and .0005, mfd. Slow Motion 2/11. Ordinary 2/3. Solid dielectric 11d.

L.E.C. VOLUME CONTROL BARGAINS.—Centralab, new line 400,000; 500,000 ohms. 1/11, with switch 1/11d.

L.E.C. MANSBRIDGE AND ELECTROLYTIC BARGAINS.—1 mfd., 10d. 2 mfd. 1/4, 4 mfd., 2/9, all Philips 750 v. test. Philco 8 mfd. electrolytic 3/11.

THE 'RADIO GOLD-MINE' GOLD SHEET.—For the greatest bargain offers in Radio History.

L.E.C. RESISTANCE BARGAINS.—H.M.V. 4 watt, 100,000 ohms 5/4d. Erie all values to 50,000 ohms 4/4d. Special: Spaghetts. Every size to 100,000 ohms 5d. Higher values 7d. or 4/8 and 5/6 doz.

L.E.C. ELIMINATOR BARGAINS.—25 m.a. L output, 4 tapings, A.C. 24/6, D.C. 12/6. State mains voltage.

L.E.C. MAINS TRANSFORMER BARGAINS.—Inputs 200-250v. H.T.7 Output 150 v. 3/11. H.T.8 180 v. 4v.3 amp 4/10, H.T.9 300 v. 4v., 4 amp 5/3.

THE 'RADIO GOLD-MINE' RED SHEET for H.P. terms on the world's cheapest Radio-Gram.

L.E.C. FIXED CONDENSER BARGAINS.—Dubilier, Polymet and Edison Bell. .0004; .0001, 2, 3, 4, 5, 6, 7, 8, 9; tubular type .0001, .0003 mfd., all 3d. 2/9 doz.

L.E.C. SUNDRY COMPONENT BARGAINS.—L.F. Transformers 1/11 H.F. Chokes 10d., V-holders 4-pin 2/4d., 5-pin 3/4d., 7-pin 6d. Switches 2-point 4/4d., 3-point 5/4d.

THE 'RADIO GOLD-MINE' for everything Surplus in Modern Radio.

L.E.C. 'GOLD-MINE' KIT BARGAINS.—Absolutely unprecedented value. Complete in sealed cartons with diagrams, instructions and sundries.

Straight 2-valve 8/6 3-valve 10/8 S.Wave Adaptor 8/6, Class B Adaptor 10/8; S.Grid 111 18/6; S.Wave 111 18/6. Special Offer-Class B kits (with Iron Core) Coils 3-valve 22/6; S.G.V. 30/-.

THE 'RADIO GOLD-MINE' at 3d. post free is the greatest investment you will ever make. The most comprehensive lists of up-to-date surplus goods yet produced; with a general price level absolutely the lowest ever. Feb. issue—illustrated—is better than ever. Going in thousands! Do not delay. Send (enclosing 3d. stamps) to-day.

LONDON EAST CENTRAL TRADING COMPANY (Dept. M.90), 23, Bartholomew Close, London, E.C.1 (telephone: NATIONAL 8523). Any goods over 10/- value Postage Free. Cash or C.O.D.

SPEAKERS: 1934 Model Permanent Magnet Moving Coil. Junior model of famous make, with universal transformer suitable for any output. List 27/6, our price 18/6, carriage paid. Cash with order—goods by return. Thompson, Electrical and Radio Engineer, 187, Sumatra Rd., London, N.W.6.

TELEVISION DISC RECEIVER complete specified Kit, 50s. Amplifiers from 50s. Cash, C.O.D. or H.P. Lists Free.—Melfo-Rad, 5, Queens Pl., Hove.

MELFO-RAD for First Specified Kits. Lowest quotations: Fury Super, 26 3s. 0d. (12s. 6d. monthly). Orbit 3tr, 75s. (10s. 6d. monthly). R.I. Class B Kit (11s. 9d. monthly). Lists Free.—5, Queens Pl., Hove.

GRAMOPHONES. Radiograms, 64 page. How to make 'm, 3d. Motors, Arms, Pick-Ups, Speakers, Horns, Springs, Repairs, Accidents. Regentprac, 120, Old Street, London, E.C.1.

ADVERTISEMENT INDEX

Airclipse, Ltd.	Page 1036
Ampion (1932), Ltd.	Inside Back Cover
British Ebonite Co., Ltd.	1018
British Institute of Engineering Technology	1038
British Pix Co., Ltd.	Front Cover Strip, 1037
Colvern, Ltd.	1018
Cossor, A. C., Ltd.	Inside Front Cover
Electradix Radios	1040
Fluxite, Ltd.	1035
Graham Farish	1037
Hayberd, F. C. & Co.	1034
Heraud, E. J., Ltd.	1034
Holmes, H. W.	1036
International Correspondence Schools	1032
King's Patent Agency, Ltd.	1038
Mullard Wireless Service Co., Ltd.	1017
National Institute of Radio Engineering	1036
New London Electron Works, Ltd.	1040
Newnes: "Radio Magazine"	Back Cover
Osborn, Chas., A.	1038
Peto-Scott, Ltd.	1029
Radio Training Institute of Gt. Britain	1036
Sifam Electrical Instruments, Ltd.	1038
Taylor, N.	1038
Thames Valley Mfg. Co.	1040
362 Radio Valve Co., Ltd.	Inside Back Cover
Tonastat	1038
Turnadge & Partners	1038
Wet H.T. Battery Co.	1038

PEARL & PEARL

190, Bishopsgate, London, E.C.2. All the following bargains guaranteed new goods. Cash or C.O.D. Carriage Paid.

IGRANIC Permanent Magnet Moving Coil Speakers. Standard Model; 7in. cone Tapped Transformer for Pentode, Power and Common. Minimum input 200 milliwatts. Maximum input 3 watts. Brand new sealed cartons. Our price 18/11.

DUBLIER 4.5 High Test Condensers, 1,000 volt D.C. Tapped 2.25. Our price 3/6.

IGRANIPAK complete tuning unit, comprising (1) Completely screened coils with built-in wavechange switch; (2) Igranik 3-gang Condenser with cover; (3) Escutcheon and Disc Drive Assembly with pilot lamp attachment; (4) Mains Switch; (5) Three 5-pin Valve holders; (6) Grid Leak and Condenser; (7) Engraved Terminal Board. Complete with circuit. List price 57/6. Our price 27/11.

IGRANIC Indigraph Vermer Dials. List price 0/- Our price 2/11.

DITTO, as above, with micrometer adjustment. List price 7/0. Our price 3/6.

IGRANIC tapped C.C. output unit. Acts as an auto-transformer giving either a step-up or step-down effect to suit any type of loudspeaker employed. List price 8/6. Our price 4/11.

IGRANIC Potential divider has a total resistance of 1,500 ohms. List price 10/6. Our price 3/11.

THE "Lincoln Super" Permanent Magnet Moving Coil Loudspeaker, all purpose universal tapped transformer for Q.P.P. Class B: Pentode, Power and Super-Power output. Will carry 3 watts undistorted output. List price 42/- Our price 19/6.

IGRANIC Class B. Driver Transformer. Tapped 1 to 1 and 1 1/2 to 1. List price 11/6. Our price 5/6.

250 Horizontal Set and Speaker Cabinets. Solid walnut (made for Philco), 22in. wide, 10 1/2in. deep 11in. high. Price, 6/11. Cost £1 to make. This item carriage forward.

MAJESTIC Flaglet, 1934, 4-valve all-electric Superhet Midget Receiver Moving Coil Speaker, medium and short waveband complete in modernistic cabinet in walnut, black and chrome, measuring 11 1/2 by 5 1/2 deep, 8 1/2 wide. Super Bargain 26/10/6.

PEARL & PEARL

All above bargains sent Cash or C.O.D. Carriage Paid. 190, Bishopsgate, London, E.C.2.

UTILITY SALES CO. offer new up-to-date surplus goods. Splendid value and carriage paid.

DISWAN 2-volt Non-spill Accumulator, 70 ampere, 61x34x33, 6/9.

OTUS Disc Drive, with Dial Lamp Escutcheon. List 5/-, our price 2/6.

OTUS Dyblock .0005 Variable Condenser, with slow motion Disc Drive Pilot Lamp Fitting, Knob escutcheon. List 9/6, our price 4/-.

IRON-CORE Screened Dual Wave Coils; also matched for S.G. circuits. Two diagrams with each coil. 2/6.

SINCLAIR P.M.I.C. Speakers for Power or Pentode, 14/-. Vatea 2-volt valves, strongly recommended, general purpose, 2/-, power, 2/6.

SELEKTUN Dual Range Screened Coils, Aerial or H.F. Full wiring diagram for two circuits. 2/9.

HARLIE Pick-up, complete with reversible head-volume control, irreplaceable reproduction.

MICROPHONE to broadcast through your own speaker easily fixed to your set—play a joke on your friends and lose that "mike" fright. Complete with full instructions, 5/-.

.0005 Solid Dielectric Variable Condenser, with knob 9d. .0003 ditto, 9d.

DARIO 4-volt Valves, super H.F., super Det., L.F., and R.C. All new. 1/3.

INDIRECTLY heated A.C. Valves, Det. and Power for any A.C. set. 5/- each.

250-VOLT 25 mA Rectifying Valve, 4-volt filament. 3/6.

SMALL but powerful Reed Speaker Unit, suitable for portable set, 3/6.

EBONITE Panels, 8x6x3/16 matt. finish, 1/-. 1 mfd. 650-volt test, Bakelite case with terminals, 1/6. 2 mfd. ditto, 2/6.

VOLTMETER, Watch Type, to Read H.T. 120 volts L.T. 12 volts nickel plated in case, very accurate, 3/-.

ALL Goods Cash with Order. Satisfaction Guaranteed.—Utility Sales Co., 27a, Sale Street, Paddington, London, W.2. Phone: PAD. 0251.

ERICSSON 3/1 L.F. Transformers. List Price, 17s. 6d. New and guaranteed. Our price, 2s. 3d. post free U.K.—Pioneer Radio, Coptic St., London, W.C.1.

BLUE SPOT 66K Units, 6/9; with chassis, 10/3; B in cabinet, 14/6. Post to Heath Radio, 2, Heath Road, S.W.8.

SAVE 50% ON VALVES

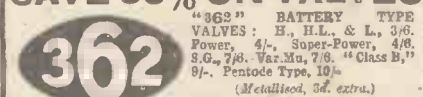

THE 362 RADIO VALVE CO. LTD. (Dept. W.), Stoneham Road, London, E.5.

AMPLION PLASTAPE

INDOOR AERIAL

10 AIR SPACED INSULATED COPPER STRANDS

15 FEET - 2/-
20 FEET - 2/6
30 FEET - 3/6
AMPLION (1932) LTD.

EVERYBODY'S TALKING *about*

ALL ABOUT THE B.B.C. STARS

RADIO MAGAZINE

MARCH



"RADIO MAGAZINE," the successful new illustrated monthly, tells listeners everything about the people who entertain them on the air.

Read all about your broadcasting favourites in the "Radio Magazine."

Special articles in the March number include: Building a Programme, Sex Appeal On The Air? Getting An Audition, Making Song Successes, An Announcer At Work.

Gossip of Studioland tells you everything about life behind the scenes at the B.B.C.

Over a hundred splendid photographs of the most popular entertainers, singers, comedians, musicians.

On sale at all Newsagents and Book-stalls, or by post 7d. from George Newnes, Ltd., 8-11, Southampton Street, Strand, London, W.C.2.

RADIO MAGAZINE



The Biggest, Brightest PICTORIAL for Listeners

Geo. Newnes, Ltd.

P.W. Gift Stamp No. 7

Printed by NEWNES & PEARSON PRINTING CO., LTD., Exmoor Street, Ladbroke Grove, W.10, and published by GEORGE NEWNES, LTD., 8-11, Southampton Street, Strand, W.C.2. Sole Agents for Australia and New Zealand: GORDON & GOTCH, LTD. South Africa: CENTRAL NEWS AGENCY, LTD. *Practical Wireless* can be sent to any part of the world, post free, for 17/4 per annum; six months, 8/8. Registered at the General Post Office for Transmission by Canadian Magazine Post.