

INSIDE! THE UNIVERSAL £4 SUPERHET FOUR

Practical and Amateur Wireless

3^D
EVERY
WEDNESDAY

Edited by F. J. CAMM

a GEORGE
NEWNES
Publication

Vol. 7 No. 171.
December 28th, 1935.

AND PRACTICAL TELEVISION



**SERVICING
SETS for
PROFIT**

Begin the New Year Well, Get—

NEWNES TELEVISION AND SHORT-WAVE HANDBOOK

By F. J. CAMM (Editor, Practical and Amateur Wireless, Practical Television etc.)

Fully
Illustrated

EVERYTHING ABOUT—Drums, Mirror Screws, Scanning Discs and other Scanning Systems, Neon Lamps, the Cathode-Ray Oscillograph. How to build Short-Wave Receivers; How to build Ultra-Short-Wave Receivers, straight and Superhet types.

NEWNES

From all Booksellers

LONDON.

Only
3/6
net

COSSOR *Quality*

SUPERHET RADIO

for

Battery & A.C. Mains Users

INCORPORATING the most up-to-date in Superhet practice these receivers employ a Pentagrid Frequency Changer in conjunction with specially designed coils, which ensure an exceptionally high degree of selectivity. A wealth of experience is behind these Superhets, and backed by the largest self-contained Radio factory in the Empire, they are above all RELIABLE.

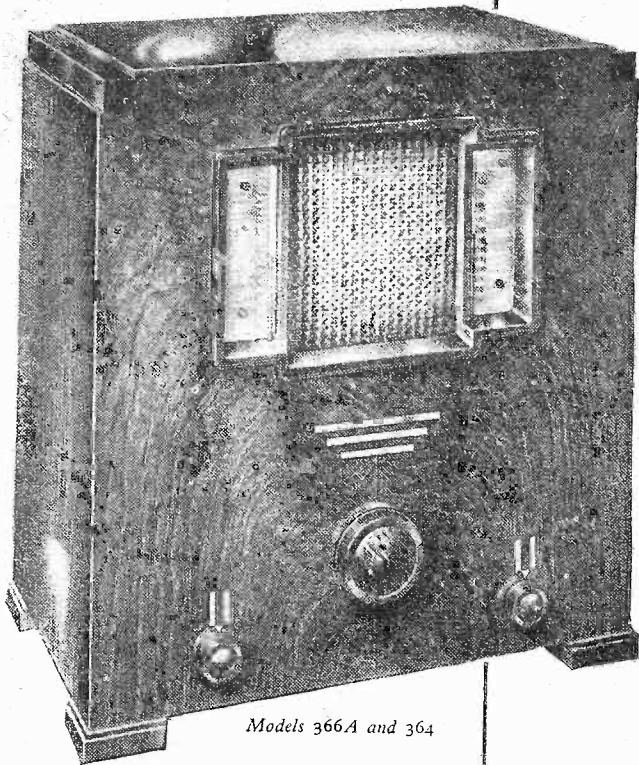

Models 366A and 364

BATTERY MODEL 366A

With Pentagrid Frequency Changer, H.F. Screened Pentode I.F. Amplifier, Double Diode Detector and Economy Pentode Output. 8" Moving Coil Speaker. Cabinet with accommodation for suitable Accumulator and Battery. Price **9 GNS**
(Exclusive of Batteries)

H.P. Terms: 17/6 deposit and 11 monthly payments of 17/6.

A.C. MAINS MODEL 364

With Pentagrid Frequency Changer, H.F. Pentode I.F. Amplifier, Double Diode Detector, High Slope Pentode Output, Full Wave Rect., Thermometer Twin illuminated and detachable Scales. Combined On/Off, Wavechange and pick-up Switch, Volume Control. 8" Mains Energised M.C. Speaker. Complete with plug and sockets for extension Speaker and for pick-up. A.C. Mains only 200/250 v. (adjust.) 40/100 cycles. Price **11 GNS**

H.P. Terms: 20/- deposit and 12 monthly payments of 20/-.

■ A NEW MODEL ■

SEVEN STAGE

BATTERY MODEL 376B

Seven stages, Anti-fading circuit with Pentagrid Frequency Changer, Variable- μ H.F. Pen. I.F. Amplifier, Double Diode Det. High Slope Driver and Class 'B' Output. Single Knob tuning, sloping detachable scale. Four way combined On/Off, Wavechange and pick-up Switch. 8" Moving Coil Speaker. Cabinet with accommodation for suitable Accumulator and Battery. Price **£29.19**
(Exclusive of Batteries)

H.P. Terms: 17/- deposit and 12 monthly payments of 17/- or 40/- deposit and 12 monthly payments of 15/-.

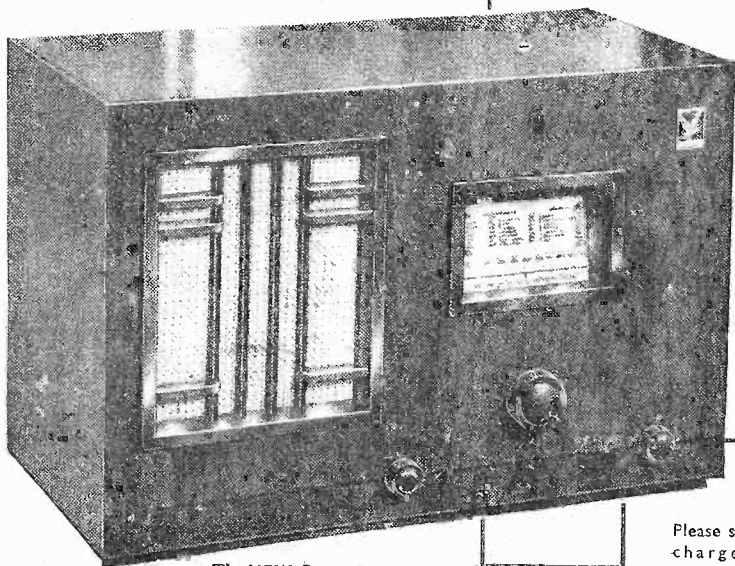

The NEW Seven Stage Class 'B' Battery Model 376B.

THIS COUPON BRINGS FULL DETAILS

To A. C. COSSOR LTD., Melody Dept.,
Highbury Grove, London, N.5.

Please send me free of charge, literature giving full particulars of the new Cossor Superhet Receiver
*Model No.
* Please state Model required.

Name.....

Address.....

RNAC. 23/12/35

INTRODUCING THE UNIVERSAL 4-VALVE SUPERHET!

See Page 486



Practical and Amateur Wireless

Edited by F. J. CAMM

Technical Staff:
W. J. Delaney, H. J. Barton Chapple, Wh.Sch., B.Sc., A.M.I.E.E., Frank Preston.

VOL. VII. No. 171. December 28th, 1935.

ROUND *the* WORLD of WIRELESS

Listen to Mexico

IN the early hours of the morning, namely, between G.M.T. 02.30-04.00, it is possible to pick up, when conditions are favourable, broadcasts from XEW, Mexico City, a 50-kilowatt operating on 337.1 metres (890 kc/s). When giving its call in English, the station claims to be *The Voice of Latin America from Mexico*, and as an interval signal strikes four bells (downward scale).

Time Changes

SINCE October the Argentine Republic has adopted Summer Time, and is therefore, now only three hours behind G.M.T.; New Zealand, on the other hand, from September 29th, has advanced thirty minutes; when it is noon in London, it is midnight of the same day in Wellington.

New Czech Transmitter

THE 30-kilowatt station installed at Banska-Bystrica may now be heard carrying out its tests on 765 metres (392 kc/s). It is destined to relay the Prague programmes, but in accordance with the Lucerne Plan, owing to the position of its channel in the waveband, must reduce its power to 15 kilowatts after sunset. Banska-Bystrica will be found in pre-War maps under its Austrian name *Neusohl*.

To Replace Rodno Radio

BULGARIA is to possess in 1936 a 100-kilowatt transmitter, which will be installed at Vakerel in the immediate neighbourhood of the capital (Sofia). The 300-watt plant which is now in operation will be transferred as a relay station to Varna.

Another 500-Kilowatt in the U.S.A.

IT is reported from New York that *The Chicago Tribune*, owner of the WGN 50-kilowatt broadcasting station at Chicago, has applied to the Federal Communications Commission for a permit to increase the power tenfold. So far, the only other 500-kilowatt transmitter in the country is WLW, Cincinnati.

Radio-Normandie's New Transmitter

ALTHOUGH rumours have been current to the effect that steps were to be taken towards the closing down of French

privately-owned broadcasting stations featuring sponsored programmes, it is interesting to read that the foundation stone of the new Radio-Normandie transmitter at Louvetot was "well and truly laid" by the representative of the Ministry of Posts, Telegraphs and Telephones! This does not point to any restrictive measures being taken by the French State Broadcasting Network.

Radio in German Excursion Trains

IN order to offer entertainment to passengers on long railway journeys, the German authorities are planning next year

On Other Pages	
	Page
Modern Coil Design ...	477
On Your Wavelength ...	479
Servicing Sets for Profit	484
The Universal Superhet 4	486
Short-Wave Section ...	487
Letters from Readers ...	490
Television Notes ...	493
Queries and Enquiries ...	495

loud-speaker installations in a number of excursion trains. They will be used for the broadcast of news bulletins, dance music, as well as the announcing of stations at which stops are made, including other instructions by the guard likely to be of use to travellers.

Radio and the French Exchequer

ALTHOUGH the French Ministry of Posts and Telegraphs had expressed the desire to utilise the income derived from the sale of listening licences solely for the development of the broadcasting system, the Chancellor of the Exchequer thought otherwise, and, as in other countries, the Ministry of Finance will get its annual "rake off."

What the Polish Listener Wants

EVERY Sunday evening the Cracow station offers to its listeners a programme made up of request items. From the tenor of these entertainments, the studio has ascertained that its hearers require neither jazz nor serious classical compositions, but music of a light popular character. "Hot" numbers have, in consequence, been banned.

Finding Jobs for the Unemployed

THE Swedish Broadcasting Corporation is now featuring every week a special employment programme in which not only are the listeners given a list of jobs available in the different districts, but may also hear practical advice respecting the various crafts. The transmission heard in neighbouring countries has also been the means of finding work for the Swedish unemployed.

Radio-Paredo Again on the Air

CTIGL, the 5-kilowatt station at Paredo, Portugal, operated by the local wireless club, and which was partly destroyed by fire some months ago, has been rebuilt. It may be heard carrying out tests on some nights on 291 metres (1,031 kc/s), between midnight and 01.30 G.M.T. The call is given out in Portuguese and English.

A Remarkable Discovery

IN a recent issue a Paris wireless journal informed its readers that Paredo (Portugal) was not a place-name, but a word made up of the initials of a local radio club. Later, the same paper corrected the statement by admitting that Paredo was a seaside resort near the Portuguese capital, a fact known to all European listeners. Reminds you of the man who thought the Piræus, the Port of Athens, was the name of a Greek cabinet minister!

The Champion Band

MUNN and Felton's Band are to revisit the Birmingham studio from Kettering. Although one of the youngest of established bands in the country, it has many notable successes to its credit, and this year it was awarded the Championship at Crystal Palace. It is the only band in the boot and shoe industry. William Halliwell will conduct a topical programme. In the interludes, Michael North is to sing at the piano.

ROUND the WORLD of WIRELESS (Contd.)

Broadcast of Winter Olympic Games

WHEN the International Winter Sports Competitions take place at Garmisch-Partenkirchen (Bavaria) between February 6-13th next, in addition to five commentators reserved for the German stations, twenty special radio reporters will provide descriptions for the benefit of foreign listeners. A special central telephony station has been installed to house the circuits destined to feed the German short-wave transmitters, with five extra lines for the international telephone network.

African Broadcasting Corporation

THE existing broadcasting network consisting of stations and studios at Cape Town, Johannesburg, Durban, Pretoria, Bloemfontein, Pietermaritzburg and Grahamstown, is to be taken over by a public trust, and will be reorganised on the lines of the British Broadcasting Corporation.

Christmas Party

CHARLES BREWER, who is producing the Christmas Party, has now completed his cast, which is as follows: Harry Bidgood and his Serenaders; the Two Leslies; "Imito," the expert in dog noises; Clapham and Dwyer; Raymond Newell; Florence Oldham; Stainless Stephen; Tommy Handley; Hermione Gingold; Doris Arnold and Harry Pepper; the Revue Chorus; the Variety Orchestra and Henry Hall and the B.B.C. Dance Orchestra.

An amusing point about the party is that the Variety Department decided that a little uplift must be introduced in an effort to rival more serious competitors. The charade will therefore be an historical one, of the Elizabethan period, and Messrs. Tommy Handley, Stainless Stephen and Clapham and Dwyer, besides being their amusing selves, will provide the uplift and instruction on this very broad-minded period of English history.

Carols from Bangor Cathedral

CAROLS will be broadcast from Bangor Cathedral on December 27th. Leslie Paul, brother of Reginald Paul, Professor of Pianoforte at the Royal Academy of Music, is the Cathedral choirmaster, and organist; he was responsible for the first three concerts to be broadcast from Bangor.

"The Babes in the Wood"

ON December 27th, from the Western Regional, a relay will be given from the pantomime, "The Babes in the Wood" presented by Francis Laidler, at the Prince's Theatre, Bristol.

"Revisited"

MAX BEERBOHM, the famous wit, satirist and caricaturist of Edwardian days, has been induced to contribute the final session of the "Revisited" series, which will be given in the Regional programme on December 29th. The inimitable Max has now lived at Rapallo for more than a quarter of a century and has just returned to his native London. He has been asked to give his impressions of the

INTERESTING and TOPICAL PARAGRAPHS

A DOUBLE ATTRACTION



Listening to a Ferranti 8½ guinea Una consolette receiver.

new London of to-day. Those who enjoyed his wit and wisdom when he was one of the best-known figures in town will be grateful for this opportunity of hearing again this famous London character. It will indeed be entertaining to the new generation to hear what restricted lives they now lead compared with Edwardian days, when all London's famous houses were occupied by families and when entertaining was universal.

Song Recital

SOME years ago, while helping a stranded motorist, Julian Were, who was the bass at the Birmingham Cathedral, heard the owner of the car humming a Bach chorale. This meeting was the beginning of The Round Table Singers who have appeared several times in the Midland programmes. They will be heard on December 29th in Parry's Songs of Farewell, augmented by another quartet. The stranded motorist, who was a music critic, became their manager. The Round Table Singers have toured in Germany as well as in this country.

"The Clock Ticks On"

JOHN MORLEY, formerly of the Birmingham Alexandra Repertory Company, recently produced "A Programme of Parodies." On rather similar lines—a mosaic of poetry, prose and music—he is to present a programme on December 30th in which he will follow the story of clocks through the ages. He has composed some

of the items himself. The songs will be given by the Midland Wireless Singers, and Mr. Morley and his wife, who is Valerie Larg, a well-known radio artist, will take the parts of the narrators.

"Midland Retrospect 1935"

ON Old Year's Night Percy Edgar, Midland Regional Director, and H. J. Dunkerley, Programme Director, will exchange reminiscences of the most interesting Midland programmes of the past year. Star events in the Midland broadcasting calendar for 1935 will be illustrated by means of records. Earlier in the evening, "Tunes of the Year" will be given by Tony's Red Aces Dance Band, and another popular feature of the evening will be an entertainment by Arthur Marshall, who has been in the Nelson Keys reviews and is a master at Oundle School.

Pantomime from Cardiff

"ALADDIN," presented and produced by Prince Littler, will be relayed from the New Theatre, Cardiff, on January 3rd. The cast includes Eileen Moody as Aladdin, Norman Griffin as the Widow Twankey, Jimmy Britton as Abanaza, Kenneth Carlisle as the Emperor, Leslie Barker as Wishee Washee, and Lena and Follie Terry's Juveniles as Pekee and Saucee.

Dance Music from Scarborough

DANCE music comes from Scarborough on December 30th, being played by Jimmy Jack and his Serenaders, broadcasting for the first time from the ballroom of the Pavilion Hotel, Scarborough.

SOLVE THIS!

PROBLEM No. 171.

Smith built the Hall-Mark Three and was very pleased with the results obtained, but when he saw the Service Data Sheet for this receiver in PRACTICAL AND AMATEUR WIRELESS he thought he would check the voltages and currents at the points mentioned. All readings were approximately correct except the voltage reading at the anode of the detector valve—this was much lower than that given in the Data Sheet. What was the reason for this discrepancy? Three books will be awarded for the first three correct solutions opened. Address envelopes to the Editor, PRACTICAL AND AMATEUR WIRELESS, Geo. Newnes, Ltd., 8-11, Southampton St., Strand, London, W.C.2. Envelopes must be marked Problem No. 171 in the bottom left-hand corner, and must be posted to reach this office not later than the first post on Monday, December 30th, 1935.

Solution to Problem 170.

Jones omitted to reduce the grid-bias voltage to the value required by the economy pentode valve. Most economy pentodes require approximately half the bias voltage applicable to super-power valves. Only two readers successfully solved Problem No. 169 and books are accordingly being forwarded to them:—T. H. Wilton, '95, Heath Road, Ashton-in-Makerfield, Nr. Wigan, Lancs.; S. Sharrock, 109, Furlong Road, Bolton-on-Deane, Nr. Rotherham.



The New Constructor's GUIDE to SET BUILDING

Details are Given for Adding a Screened-Pentode H.F. Amplifier to the Simple Set Described Last Week
By FRANK PRESTON

the three-gang condenser (if used) should be mounted in the front centre of the chassis. three-point switch (S.2), a screened H.F. choke of good quality a .0002-mfd. fixed condenser (C.5), a 1-mfd. fixed con-

MOST of those who built the simple crystal-type receiver described last week will no doubt by now have it operating satisfactorily, and will be ready to make additions to it. On the other hand, there may be some who find the little set such an excellent "stand-by" arrangement, suitable for use when speaker reception is not required, or while the accumulator is being charged, that they may have decided to keep the set in its original form.

The first addition to the set which will be described is an H.F. amplifier, and this can be added quite simply as a separate unit, or an entirely new set can be made, using the original parts along with a few extras. It is recommended that the little baseboard be scrapped, and that the new set be built on a new chassis which will serve for all of the other circuits which will be dealt with in the series. A metallised chassis will be required, and this should be 12in. long by 10in. deep, and fitted with 3in. sides. It should be drilled for three valve-holders, as shown in Fig. 1, although only one of these holes will be used at present. The two terminal-socket strips should be fixed to the rear side of the chassis, as described in previous articles, and

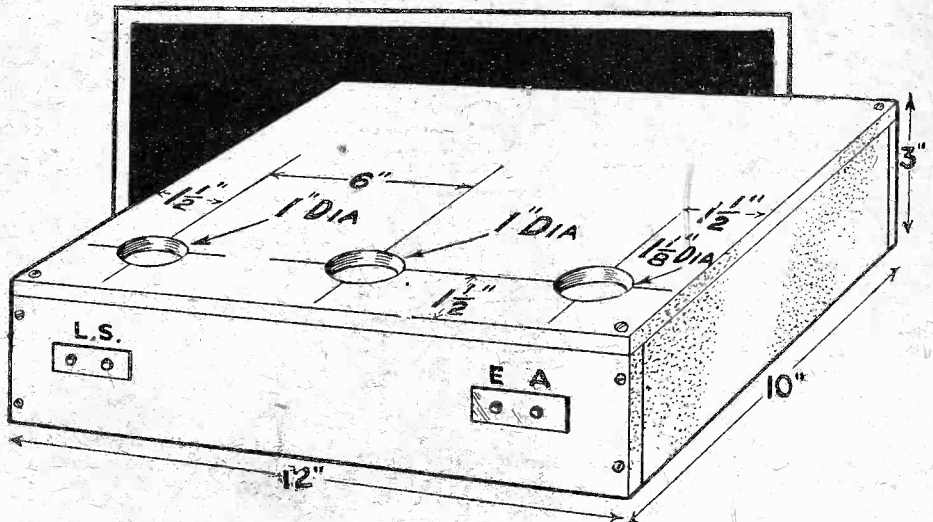

Fig. 1.—This shows the dimensions of the chassis and position of valve-holder holes.

Additions Required

The only new parts required are: a four-pin valve-holder, a second coil like that used in the "crystal" set, another

condenser (C. 4), an L.T. on-off switch (S.3), and a variable-mu H.F. pentode valve. These parts are wired as shown in Fig. 2, where the complete theoretical and pictorial circuits of the valve-and-"Westector" arrangement are given.

It will be seen that, in the complete circuit, the bias supply for the rectifier is shown as being obtained from the G.B. battery and 50,000-ohm potentiometer, whilst the variable-mu valve is used, for the present, without variable grid bias. The connections to the new (now aerial) coil are marked with the letters A to D, these being the same references as were given last week when connections for three different types of coil were illustrated.

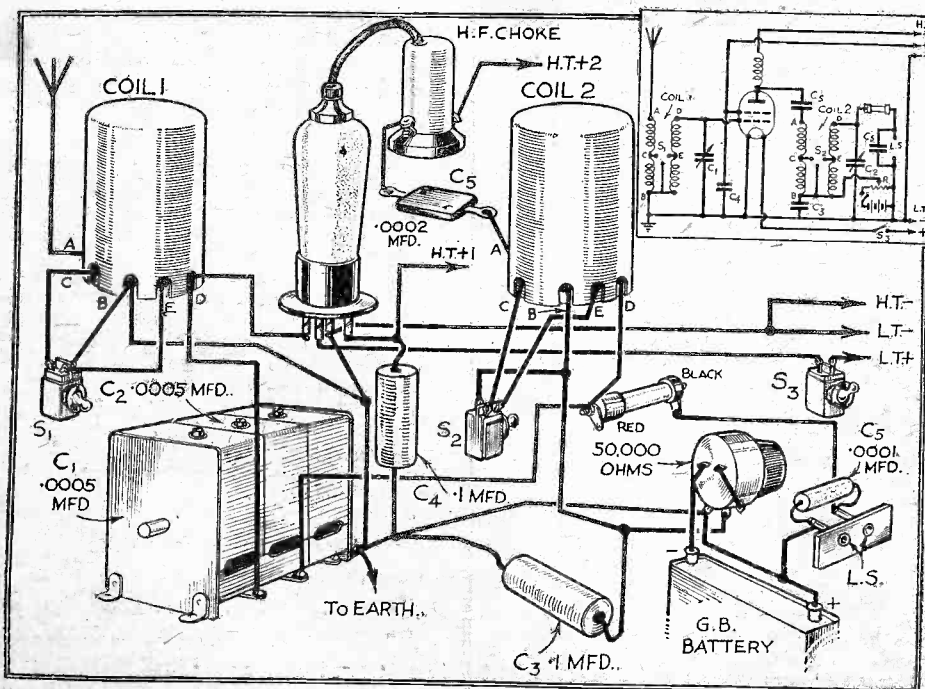

Fig. 2.—Pictorial and theoretical circuits of the valve-and-"Westector" arrangement.

Component Arrangement

The positions of the components on the chassis are indicated approximately in Fig. 3, although the actual disposition is not very critical, and slight variations are permissible. Nevertheless, if the complete superhet is to be built eventually, it is wise to follow the layout as closely as possible. High-tension and low-tension batteries are, of course, required now, and flexible leads are used for connection to these, the five lengths of flex being twisted together and passed through a hole in the rear of the chassis.

Suitable Parts

It might be helpful to many readers if a few details are given of the new parts which are required. Particular makes will not

be specified, although a few suitable types may be mentioned. The coil, of course, should be the same as that used for the original little set, and if it is proposed to make the final superhet it is suggested that the Varley component mentioned last week be employed. It has been assumed that constructors will use the Polar three-gang superhet-type condenser, although for the present circuit, two separate .0005-mfd. condensers could be used if desired. In connection with the gang condenser it should be mentioned that a drive is also required, since this is not supplied with the condenser. There are several different patterns supplied by Polar, however, and a choice can be made according to the shape preferred. In any case, the method of fitting to the condenser will be obvious.

The valve may be a Cossor 210 V.P.T., Osram V.P.21, Mazda V.P.215, Hivac V.P.215, or a similar type in other makes. As to the screened H.F. choke, this should be a good one fitted with a screened pigtail;

suitable voltage can be found later. The H.T.+2 lead should be applied to the 120-volt socket of the battery, whilst the H.T.— should be taken to the negative socket. After switching on by means of the Q.M.B. on-off switch, and setting both wave-change switches to either medium or long waves, it should be possible to tune in stations exactly as before, except that signal strength should now be much greater and additional transmissions should be heard. After it has been found that the set is functioning, however, the effect of varying the screening-grid voltage, by means of the wander-plug tapping H.T.+1, should be tried. In most cases it will be found that optimum results are obtained when a voltage of 72 is employed, but this depends partly upon the actual valve used, and partly upon the condition and true voltage of the battery.

Adjusting the Trimmers

Even when this has been done the receiver

turned in the opposite direction to ensure that the correct settings have been obtained. It is important that, while adjusting the trimmers, the tuning knob should occasionally be moved slightly, the object throughout being to keep signal strength at its highest level.

What to Expect

Even after the high-frequency valve has been added it should not be expected that the receiver will operate a loud-speaker, because it will not, except in a few instances where the set is used very near to a broadcasting station. Additionally, it should be remembered that the "Westector" is not yet being used in ideal conditions, since for its most successful operation it should be preceded by not less than two amplifying stages. At the same time, however, the circuit now in use has proved to be extremely satisfactory, and it has been possible to receive upwards of ten stations with it, at good 'phone strength. It is also reasonably selective, and capable of cutting out the local stations without difficulty when they are not at closer range than a few miles; the use of two tuned circuits, each of which is fed from a loosely-coupled primary winding, ensures a degree of selectivity sufficient for most needs.

The Circuit—Technical Details

Before proceeding to add an L.F. amplifier and carrying out further practical work, it might be helpful to new readers to have a technical description of the circuit as represented by Fig. 2. Briefly, it comprises a screened H.F.-pentode amplifier, followed by a "Westector" detector; the aerial feeds into the first valve through a high-frequency transformer with tuned secondary; the coupling between the two stages is by means of a parallel-feed H.F. transformer with tuned secondary. The latter circuit is rather unusual, since it is a combination of tuned-grid and tuned-transformer coupling, but is particularly convenient in this instance, and ensures stability (the opposite of uncontrollable oscillation) as well as providing selectivity and a high degree of efficiency.

Next week details will be given for adding a low-frequency pentode amplifier, which will increase the signal output and make the receiver suitable for use with a loud-speaker. Comparatively few new components will be required and all, excepting perhaps the valve, are inexpensive.

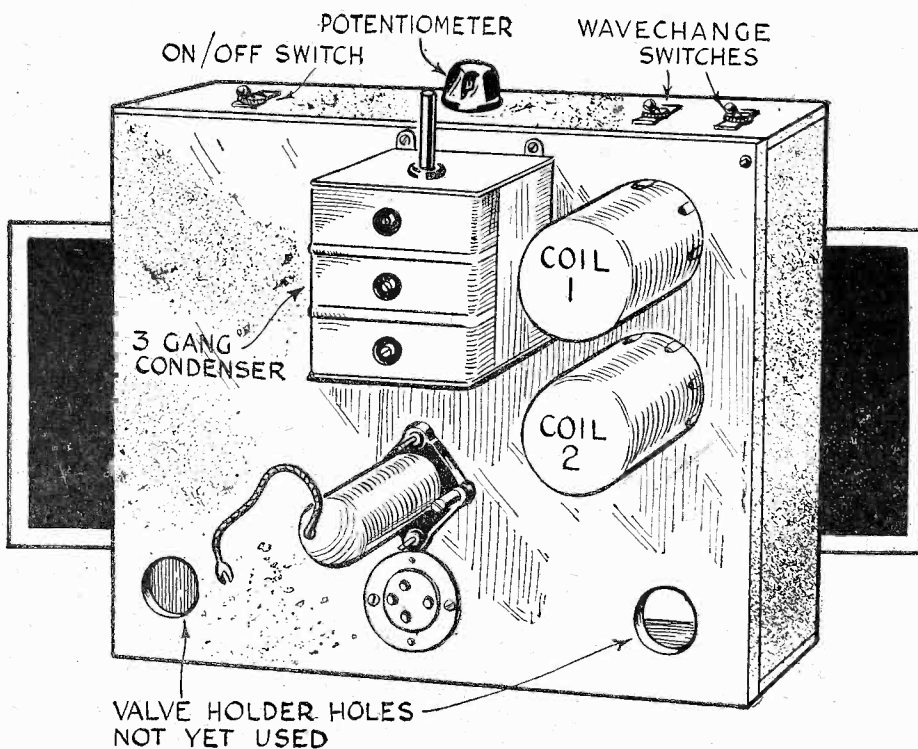

Fig. 3.—This illustration shows the disposition on the chassis of the principal components. Those not shown, such as the "Westector" and tubular condenser, may be placed below the chassis and supported by the wiring.

there are suitable examples in the Wearite and Bulgin ranges, to mention just two. The fixed condensers can be of any good pattern, although the tubular types are generally most convenient and inexpensive. As the condensers will never be subjected to more than about 120 volts the working voltage is unimportant, as the lowest rating is 200 volts.

Testing the Set

When the parts have been assembled and wired the receiver can be put into use by connecting the two L.T. leads to the terminals of a 2-volt accumulator. By the way, if a new accumulator is being bought, and if the complete superhet is to be built eventually, it will be worth while to get a good one with a capacity of not less than 40 ampere-hours, since this will prove most economical in the long run.

Of the three high-tension leads, that marked H.T.+1 should be connected to a tapping on the 120-volt high-tension battery between 60 and 78 volts—the most

may not be functioning as well as it should, due to the fact that the two tuned circuits are not correctly "trimmed." This can easily be checked by varying the capacity of the trimming condensers fitted to the three-gang unit. The adjustment is made by turning the screw heads, which can be seen through the three circular holes in the top of the condenser. As the first two sections only have been used, however, it is necessary to deal with the trimmers on these two alone. A narrow-ended screw-driver is required, and a long one with a wooden handle is to be preferred. First of all tune to a fairly weak station which can be received near the bottom of the tuning scale; bring this to its greatest possible strength by carefully turning the tuning knob, and then slowly turn the first trimming screw very slightly in one direction, and then in the other. The same process should then be applied to the second trimmer, but if it is found that either screw requires to be turned right down or unscrewed to the full extent, the other one should be

men only

The Magazine devoted Entirely to Men's Interests

Contributors Include

ERIC LINKLATER

TAFFRAIL

BERNARD DARWIN

A. G. STREET

SIR SEYMOUR HICKS

Etc., Etc.

24 Colour Pages of HUMOROUS DRAWINGS by LEADING ARTISTS.

January Number
On Sale Everywhere

1/-

Modern Coil Connections—2

I.F. Stage Magnification

THE use of three or more tuning circuits at the signal frequency, and the addition of an acceptor circuit resonant at the intermediate frequency in the aerial lead, shows that second-channel whistles need not be tolerated. Henceforth, set designers will choose any suitable frequency for the I.F.T.'s dependent on the features of the superhet. For example, 110 kc/s allows high I.F. stage magnification whereas 465 kc/s, now advocated in certain radio quarters, provides somewhat better quality, as it lends itself to variable I.F. selectivity control. Loss of amplification consequential to the use of lower wavelength I.F.T.'s can be well compensated by modern valves.

Variable I.F. selectivity in all its forms may be described as a means of eliminating the compromise between selectivity and fidelity of reproduction, which has been the feature of most superhet receivers to date.

It is desirable to name at this stage the aims of designers with respect to the tuning coils. Obviously there are no "hit and miss" methods, each radio engineering staff setting itself the task of providing an individuality of construction and results for each class of receiver. The general trend seems towards enhanced selectivity; means for more accurate tuning, by automatic or visual arrangements; and provision for variable selectivity, the latter control acting partly for "tone" (frequency) compensation on radio, and primarily for heterodyne-free reception. There is also a tendency to cut down the number of signal circuits, which leads to lower high-note losses, but necessitating more efficient tuning coils and/or greater I.F. selectivity.

Superhet Receivers

An analysis of the construction of 40 table model superhet receivers, including both battery and A.C. types, and to designs which were in force up to the date of the last exhibition at Radiolympia, disclosed the following features:—

Number of valves (excluding rectifier in the case of A.C.)—20 per cent. 3-valve, 55 per cent. 4-valve, 15 per cent. 5-valve, and 10 per cent. 6-valve.

Type of Oscillator "valve"—5 per cent. Pentagrids, 27½ per cent. Heptodes, 40 per cent. Octodes, 22½ per cent. Triode Pentodes and 5 per cent. separate Oscillator Valve.

Tuned Signal Circuits, including oscillator, 85 per cent. 3 coils, and 15 per cent. two or four coils.

Types of Signal Circuits.—82½ per cent. Aerial bandpass coils and oscillator coil, 17½ per cent. single coil circuits. 72½ per cent. of the tuning units were air-cored, and 27½ per cent. iron-cored.

Number of I.F. Tuned Circuits: 97½ per cent. 4-circuit comprising two I.F.T. units, tuned on both primaries and secondaries, 2½ per cent. 6-circuit. All the I.F.T. couplings were fixed at predetermined band-widths. 97½ per cent. were air-cored and 2½ per cent. iron-cored.

It was only possible to obtain information in the case of 24 of the 40 sets with respect

Further Details of Modern Coil Design, including Band-pass Filters and Litz-wire Coils are Given in this Article. By G. V. COLLE.

to the intermediate frequency: 1 set 110 kc/s, 1—111 kc/s, 1—112 kc/s, 1—115 kc/s, 2—117 kc/s, 1—123 kc/s, 5—125 kc/s, 5—127 kc/s, 2—128 kc/s, 1—130 kc/s, 2—456 kc/s, 1—470 kc/s, 1—473 kc/s.

These figures, and especially those covering the I.F.T. units, prove that, prior to the Exhibition, variable selectivity was untried commercially, except perhaps in the isolated instance of one expensive radiogram. The home constructor is now well provided for, as the accompanying illustrations of such units prove.

It was pointed out in the first of these articles that no really revolutionary changes had taken place in the design of tuning coils in recent years. This statement takes into account the development of iron-cored coils, which were to be found in twenty-seven and a half per cent. of the

from the last I.F. stage is connected in the Q.A.V.C. valve-grid path.

A similar tuning scheme applied to a crystal controlled I.F. monitor valve to actuate a valve relay used in the Aerodyne "Aero-magic" receiver for electrically operated remote tuning adjustment.

Yet another ingenious application of I.F. coils for automatic tuning correction can be seen from the circuit of the Murphy A28C receiver. Here a diode valve with a tuned circuit in each anode lead, one tuned slightly above, and one below the intermediate frequency are used to control a further valve connected to the oscillator circuit. A person unskilled or careless in operating the set will tune in a station slightly out of resonance, causing sideband screech and probably adjacent channel interference. By electrical means the automatic tuning correcting valves "drift" the oscillator to within .5 kc. of the correct beat frequency.

Band-pass Filters

Early direct-coupled band-pass filters, exemplified by the Varley square-peak unit, are now being invoked in modified, and smaller, form for small modern superhets. The Varley filter sections are wound on a common former with a single incomplete metal band acting as a dead-end turn fitted midway to regulate the coupling. Modern versions employ several open-circuited turns for the same purpose, and a further variation is to use two separate, unscreened dual-range band-filter elements and stand them a predetermined distance apart to achieve a similar effect.

Early band-pass filters were characterised by unequal bandwidth effects at different wavelengths, unequal amplification, and particularly so with respect to medium and long waves. Usually the long-wave band exhibited a higher degree of signal amplification than on the medium range, due to the long-wave coils possessing a better R/L value per microhenry.

Consider, for instance, an early commercial unscreened coil of 180 microhenries which had an average H.F. resistance of 6 ohms, giving an R/L value of .033 ohms per microhenry.

The long-wave inductance was 2,000 microhenries, and the H.F.

resistance 35 ohms, providing an R/L value of .016 ohms per microhenry. Thus, on long waves the "goodness" or efficiency was more than twice as great as on medium waves. If the H.F. resistance had been increased to between 60 and 70 ohms by winding with a finer wire to the same 2,000 microhenries inductance, amplification would have been nearly constant over both wavebands.

In the interests of selectivity it is obviously more undesirable to reduce the long-wave performance than to tolerate unequal signal amplification. The present and obvious course is to retain the superior high-wave characteristics, and increase the medium-wave coil efficiency by replacing the single conductor silk-covered wire with,

(Continued overleaf)

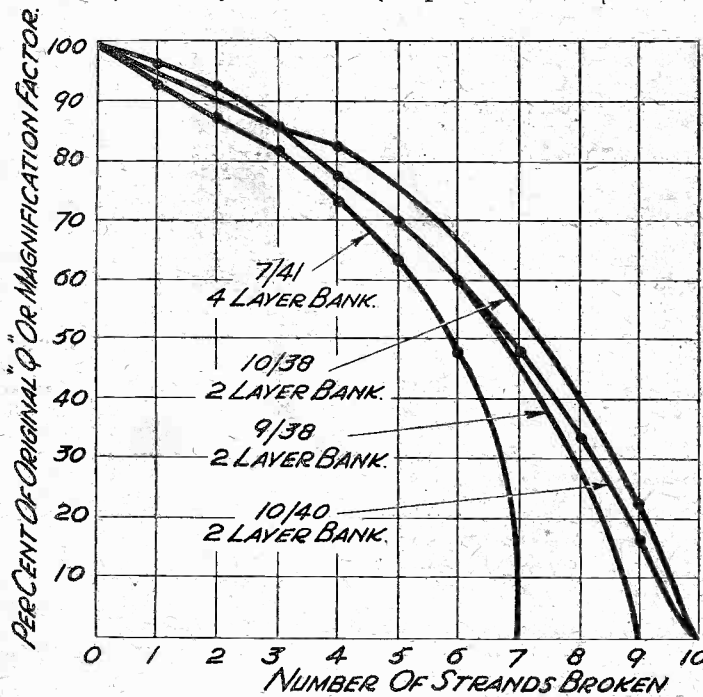

Showing loss of efficiency due to broken strands in Litz-wire bank-wound coils each 250 mcs, measured at 1000 kc/s.

forty commercial receivers examined. Considering that in 1933 not more than two per cent. of commercial sets incorporated these units, it is obvious they are steadily gaining favour.

Unquestionably the greatest advance in coil technique has been in the application of tuning units to circuit schemes which previously required mechanical arrangements exclusively to operate them.

In the early days of Q.A.V.C. (quiet automatic volume control) the L.F. valves were "muted" by means of sensitive relays connected in the anode circuits of the controlled H.F. valves. Nowadays a separate valve, or even a special circuit in the diode detector "network" is detailed to perform this operation electrically. A coil tuned to the intermediate frequency and operating

(Continued from previous page)

say, 9/40 or 9/42 silk-covered Litz wire.

For the reason that cotton-covered wires tend to absorb moisture this class of conductor is now rarely used in high-frequency circuits. Moisture in the insulation puts up the effective H.F. resistance, whereas doping the wire, even with special mixtures such as Acetone or thin shellac varnish to avoid absorption, offsets the decrease in resistance despite careful baking prior to varnishing.

Enamelled Litz Wire

The most popular conductors for coil winding are now enamelled Litz strand, single- or double-silk-covered overall in the following combinations: 7/41, 10/38, 9/38, 10/40, and 9/42. These conductors are employed on both air and iron-cored units, although similar combinations, but using separate single-silk-covered wires, and then single- or double-silk-covered overall are also popular.

Enamelled Litz wires as described are naturally more expensive than single solid conductors, but they represent the most inexpensive form of wire construction that will provide the most desirable coil features. From the coil manufacturer's point of view, these wires are preferable to the all-silk-covered Litz, which, for equal wire gauge and numbers of strands, is of larger overall diameter.

To wind a medium-wave coil of given inductance with the all-silk Litz a greater number of turns are necessary as compared with the enamelled Litz, and this has the undesirable effect of raising the resistance (D.C. and H.F.) above a level which is physically practicable. A disadvantage in the eyes of the home constructor is that considerable care has to be exercised in stripping and cleaning the ends of fine enamelled wires to avoid breakages.

This possibility is remote in the case of all-silk-covered Litz and hence in the hands of the average radio handyman this latter wire is likely to prove more satisfactory. It is obvious that broken Litz strands will affect the H.F. resistance of the coil, and hence its "Q" or goodness factor. The loss of efficiency may be readily gauged from an accompanying chart which is

applicable to both enamelled and all-silk-covered Litz.

Coil-winding plants are usually arranged with chemical means for stripping and cleaning the ends of fine enamelled wires. Owing to the composition of the enamel covering varying with each make of wire, only the wire maker is in a reliable position to recommend suitable solvents.

The term "Litz" (the full name is "Litzendracht") implies that each strand of the "conductor" is separately insulated. H.F. currents, which normally travel along the surface of each conductor, are thereby given a broad path to travel, whereas if the conductor consisted of a number of bare copper strands contacting to each other, the effect would only be equivalent roughly to a single solid conductor which would offer a higher impedance.

Litz Air-cored Coils

Most enamelled Litz air-cored, medium-wave coils are bank or slot wound on formers varying between 1 in. and 2½ ins. diameter. In the smaller sizes plain solenoid windings are unsuccessful owing to the poor L/D or "form" factor brought about by the inevitable large diameter of the conductor. A few coil makers machine-wind medium-wave Litz coils on the lattice-weave principle, but, generally, this construction is confined to I.F.T. and long-wave units.

For the slot-wound medium-wave coils, cellulose acetate transparent bobbins are preferred owing to their low dielectric losses. These formers comprise one to three slots per section, and two or more such sections are used for the one M.W. coil. For air-cored tuning coils the bobbins are split so that they will "spring" on to a main bakelised former. One great advantage derived from this form of construction is that haphazard slot winding is possible by unskilled labour, but accurate inductance matching can be achieved merely by moving one bobbin relative to the other, the coils then being fixed in place with a low-loss adhesive such as bakelite cement or acetone.

Graded Coils

From the set makers' viewpoint, the choice of a particular form of coil con-

struction is often wrapped up with its adaptability to rapid and accurate inductance matching. It is an expensive matter to remove by trial and error (on the inductance matching bridge) turns of wire, and this is more true of coils wound with Litz. Early coils having no provision for inductance variation other than by removing turns (coils with too low inductance values were rejected) were graded.

The growth in popularity of calibrated tuning dials, and the increasing accuracy of calibration now demanded, renders graded coils unsuitable for modern sets, except for the more simple and inexpensive versions.

Various methods have been evolved to overcome the difficulty, such as grinding the outer surface of the main coil former to within .001 inch of a standard and rigid specification and micrometer testing of the wire and silk covering to an accuracy of .0005 inch. A number of patents have been filed covering inductance matching by spacing off a few of the coil turns, and means for bringing these turns close and or farther away from the main winding. On a solenoid construction it is found that the coil field is most intense about five turns or so from the high-potential end. Hence by an arrangement which permits the wire to be moved turn by turn very accurate matching is possible with the minimum displacement of wire.

Experience has shown that air-cored, long-wave coils, so long as they are constructed to very rigid engineering principles, need not be so accurately matched, as slight variations can be compensated by tiny "padding" condensers. This is perhaps just as well, because most long-wave windings are slot, pile or honeycomb wound, and unless sectionalised (which is rare) do not lend themselves to rapid matching.

In the estimation of the writer, the growth in popularity of iron-cored coils for commercially made sets has been brought about purely by the manner in which these units adapt themselves to accurate and quick matching. Their greater cost is more than offset by the saving in labour charges, and while this may be pleasant in the eyes of those who sponsor them, yet it seems a rather negative way of acknowledging their technical merits.

Flights of Fancy

IS it too much to suggest that some day our rooms will be fitted with a number of concealed speakers in different positions, with switches enabling the sound distribution to be varied to suit the programme being received? The writer has recently conducted some experiments on these lines with really astonishing results. A speaker in a 3ft. square baffle suspended cone downwards a foot or so below the ceiling at the far end of the room gave a new naturalness to a cinema-organ broadcast. Next, a programme of orchestral music came over best from a speaker arranged cone upwards flat on the floor—the nearest practicable approach which could be devised to a speaker set in the floor itself. The usual radiogram position of the speaker was voted second best for this class of item, and also the most generally satisfactory for plays, and for the more formal kinds of talks. But the rather more intimate talks, news bulletins and light solo items were heard at their best from a speaker mounted at mantelpiece height, the position in the room varying for different classes of item.

It would appear, therefore, that far too little attention has been paid in the past to

HERE AND THERE

sound distribution in the home, and this, again, offers a useful field for both speculation and experiment.

World of Blind Playwrights

ALL over the world, wherever English is spoken, blind men and women are writing plays. This is borne out by the sales of a Braille book, published by the National Institute for the Blind in connection with its competition for the best broadcast play by a blind writer.

As a guide to competitors, the Institute issued a Braille edition, in cloth, of Mr. Val Gielgud's book "How to Write Broadcast Plays." Within a few days of publication, the whole edition was sold out, many orders coming from the Dominions and America. The demand continues, and the Institute has now produced a cheaper edition in paper covers. But a reprint of this will certainly have to be made almost

immediately. "Theoretically," says the National Institute "the person best suited to write a broadcast play should be a blind person. He should be able to understand, naturally, the technique of drama produced for an unseeing audience."

Large Increase in Radio Licences

ANOTHER large increase in the number of wireless receiving licences taken out has just been registered.

The Post Office announces that 931,776 wireless receiving licences were issued during November, 95,605 more than the previous month. The number of licences in force at the end of November was 7,369,239, compared with 6,660,659 for November, 1934.

"Mother Goose"

LISTENERS who heard Tom Arnold's production of "Mother Goose" in rehearsal during the recent "Round the Northern Pantos" broadcast, will be glad to hear that a long excerpt from this pantomime is to be relayed to Northern listeners on January 1st. The stars are George Formby, George Lacy, Anne Ziegler and Molly Fisher.

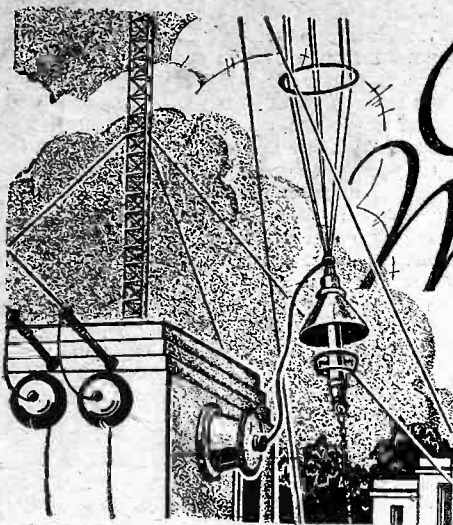

On Your Wavelength

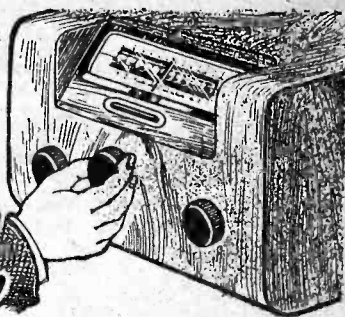

By Jhermion

The Licence Problem

I NOTED a few weeks ago on this page the efficiency of the Post Office in attending to wireless licences. For the nimble bob that they get out of the 10s. listener's licence they do an extraordinary amount of work. They remind you when your licence is overdue, unlike the hard-hearted Ministry of Transport, which prefers you to let your licence lapse so that the police can collect a nice crop of cases each year and thus augment the national revenue. The French Minister of Posts and Telegraphs has decided that every wireless set must have a receipt for the year's tax fixed to it; bicycles are, of course, already compelled to carry a licence and to pay a tax in France. I hope that the P.M.G. will not go one better than the French Minister by making listeners have the licence fixed in an appropriate holder and attached to the front door of every house in which radio is installed. Such a scheme would, of course, enable the police to enliven their

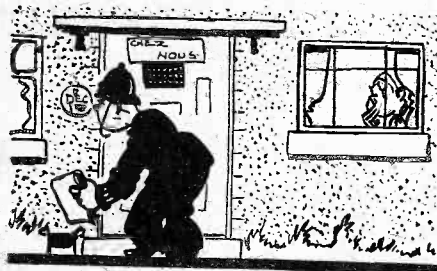

Listener's licences to be attached to the front door?

nocturnal perambulations by examining the licences. The wireless licence is the cheapest form of entertainment. I cannot imagine what type of person it is who would balk the B.B.C. of its modest due, considering what it gives in exchange for it. I place a man who endeavours to dodge payment of his wireless licence in the same category as a man who would rob a small child of its sweets or a dog of its bone.

A Code in the Dose

FOR the past few days I have been suffering from a cold, and, in spite of all the remedies, it persisted in taking its own course. Compulsory incarceration is anathema to me. I tremble to think what conditions under such circumstances would be like were there no radio. It is a soothing balm, with the one exception that my temperature is likely to rise rapidly as soon as a silky-voiced crooner comes on the scene. I have tried hard, but I cannot bring myself to like these human curiosities, and I am glad to note a return to the balladic style

of song. If all crooners were compelled to live on an island together, they would be regarded as the halfway step between a human being and the Simian tribe, and thus bear out Darwin's theory of evolution. As it is, their peculiarities are obscured by contact with normal individuals.

These idle thoughts impress themselves upon me whilst listening to the radio when I had nothing else to do, and between frequent bathings of the feet in mustard baths. When you have opportunities of listening all day to the radio you become expert at picking out the high spots in the programme. I suggest that during the day they should broadcast a "Sick Listeners'" hour.

Old Sets

I AM surprised at the number of really well-to-do people who have yet to learn of the strides made in radio. I refer to the fact that they continue to operate sets rather more than five years old, and seem most annoyed should a valve blow after this length of time. Whilst splitting a bottle of beer the other day with a representative of one of the leading radio manufacturers, he cited several cases of customers of theirs who had written complaining that after four years' service the set had suddenly gone wrong. These customers were extremely annoyed with the reply they received, that after four years it was only reasonable to expect that the valves required to be renewed. One or two of them wrote rude letters suggesting that all the manufacturers wanted to do was to sell valves. Some of these parsimonious people also complained of the selectivity which was steadily getting worse, and wanted to know whether the manufacturer could not do something about it. These sets were, of course, designed for the conditions four years ago, and although the manufacturer generously offered to modernise these old sets, the customers thought it could have been done for nothing. Even some home constructors continue to operate sets which are out of date.

The Mania for Chatter

WHY do so many people plan to listen to a particular programme, such as the performance of Straus's *Waltz Dream*, settle themselves carefully in their chairs at the appointed hour, and then talk all the way through the programme? It is difficult to be anything but rude to such people, and makes me long to don a pair of headphones. After all, radio is not intended as a background to inconsequential conversation. You would not go to a theatre and talk during the performance without being asked to leave the auditorium. Unfortunately, with a wireless programme the performers in the studio are unaware of the discourtesies shown to them. Perhaps it is

just as well, for artists, being temperamental people, might walk off the stage or out of the studio to show their disgust.

Trial and Error

A FRIEND of mine recently purchased a 6-valve superhet radiogram, but upon delivery of the receiver found that it was far from satisfactory. He accordingly phoned the manufacturer of the radiogram, who immediately sent down one of their employes to service the receiver. After he had made the receiver work satisfactorily, he explained that since the production of their first models, they had found that a component had proved defective. Surely it is up to the manufacturer to experiment with a receiver before selling it to the public, and leaving them to find out the mistakes in the design of the receiver.

A Pennyworth of Music

I LEARN that a receiver and radiogramophone, which can be operated by inserting a coin in a slot, are being introduced for use in licensed houses, restaurants, and similar places. For 1d. these models give two sides of a popular record, or a broadcast item. The cost to the subscriber is 10s. weekly for the radiogram, or 5s. for the receiver, the usual radio licence and the local justices' music licence.

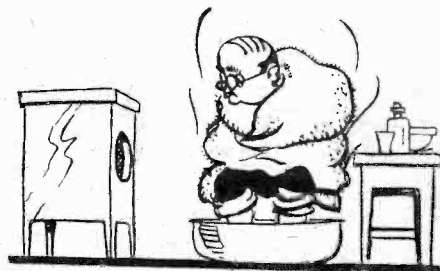

I've had a code in the dose!

The Straight Three

I DO not hold any dogmatic views concerning the relative merits of the "straight" and the superhet circuit, and I make frequent use of both arrangements. Generally, however, I find that the superhet is more in keeping with my requirements when I have a desire to "reach out," but I had rather a surprise a few evenings ago on trying a "straight" three-valve set which I had made up from a few odd spare parts. Believe me, notwithstanding the fact that the aerial—if such you can call it—consisted only of five feet of wire, I was able to bring in more than twenty stations at good speaker strength after dark. In every case the output was sufficient easily to fill the room and make reception comfortable.

Special pains had not been taken in assembling the set, which was intended as a present for a maiden aunt, and the circuit was of the well-known and well-tried kind. In fact, the only departure from usual practice was to include an H.F. pentode in

(Continued overleaf)

(Continued from previous page)

the detector circuit, as well as in the high-frequency stage. This valve was operated at a fairly high anode voltage, since a good 100-henry low-frequency choke was used in place of the customary fixed resistance in the parallel-fed transformer coupling. The set was made for A.C. operation, and as the rectifier gave an output of 250 volts the detector anode received approximately 150, and the screening grid 90 volts. Contrary to expectations, reaction control was remarkably smooth when used, but results were so good without reaction that I decided to dispense with the control, leaving only the variable-mu potentiometer for controlling the sensitivity and volume.

I am now in two minds whether to give the set away or keep it and quickly assemble another for my aunt!

Voltage and Current

WHILST explaining to a friend how he should charge his accumulator from the D.C. mains, I emphasised that great care should be taken to avoid the possibility of receiving a nasty shock when handling the accumulator terminals. I should explain that the method I had recommended was to connect the accumulator in series with a 100-watt lamp in order to obtain a charging

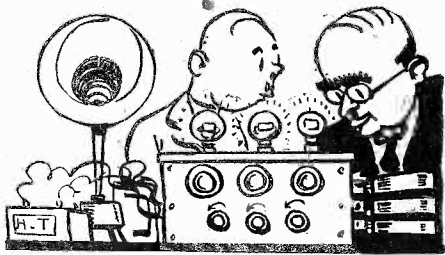

Old sets still in harness!

current of about .5 amp. My friend could not understand how it could be possible to receive a shock from the leads, since the voltage applied between the accumulator terminals was only about 3 (2.7 is the actual voltage required for charging a 2-volt cell); as he pointed out, a shock could not be received by coming in contact with a supply of 3 volts. The important point to remember in this connection is that the voltage is dependent upon the current flowing through the circuit, and that if there is no "load"—in other words, if the battery is not in circuit—the voltage between the leads is that of the mains, although the current passing through the body when the leads were touched would be negligible.

A Frayed Aerial and Temper!

OWING to the fineness of the individual strands of an aerial of mine these corroded and broke after a very short space of time, and consequently there were only a few fine strands of wire acting as an aerial, with high-resistance effects set up at the broken ends. It is thus necessary to exercise caution when trying improvements, and to think of the many varying details which enter into a scheme.

Too many people take the aerial for granted, and use the cheapest possible wire even on the most expensive sets. Before suspecting your set, carefully examine the aerial and the earth. A friend of mine complained to me the other day that his set had suddenly developed crackle. Knowing the particular receiver, I made the usual suggestions as to possible causes, including the elementary one that he should disconnect the aerial with the



Notes from the Test Bench

Superhet Control

IN home-constructed superhet receivers it sometimes happens that the H.F. control cannot be rotated to its maximum setting without oscillation occurring, and the control acts in a somewhat similar manner to a reaction condenser on a straight set. In one way, this is an advantage as it enables the listener to get optimum results from distant stations. In commercial receivers oscillation is avoided by fitting fixed bias resistances to the frequency-changing and I.F. amplifying valves of sufficiently high value. This can easily be done in a home-made set, or if the H.F. control is mounted in an easily accessible position it will only be necessary to connect one resistance between the centre terminal of the control and the lead normally connected thereto.

Oscillation Howl

IN some cases it is found that the above-mentioned oscillation takes the form of a howl instead of the normal rushing noise. This seems to be due to high-frequency currents passing to the L.F. amplifier, and can generally be cured by connecting a resistance of approximately 3,000 ohms in the common positive H.T. lead to the I.F. and frequency changing valves, and then connecting a high capacity condenser of the non-inductive type between this resistance and H.T.—It is also found that the use of high-capacity electrolytic condensers across the bias resistances of the I.F. and F.C. valves tends to minimise this trouble.

Valve Substitution

WE often receive queries from readers concerning the substitution of valves in their receivers, and we sometimes find that serious damage has been caused by using unsuitable valve replacements. In a receiver having a battery H.T. supply, H.F. and detector valves can generally be replaced by valves of different make from the ones originally fitted without fear of any damage occurring, although in some cases the substitution of a modern H.F. pentode in place of an old S.G. valve is likely to produce instability. In a mains operated set, however, great care should be taken in choosing substitute valves even in the preliminary stages of a receiver, and it is always advisable to consult the manufacturers before making any changes. In the case of the output valve, whether of the battery or the mains type, alterations to the bias voltage is almost invariably necessary when a substitution is made, and in the case of the mains valve, reduction of the anode voltage is sometimes desirable. In a battery operated receiver the bias voltage can easily be varied by transferring the G.B. plug to the correct socket, but in mains sets the bias is derived from the voltage drop across a resistance, and therefore it is necessary to change this resistance when the output valve is changed. A further precaution must be taken if the new valve requires a higher bias voltage than the old one; care should be taken to ascertain that the bias resistance by-pass condenser has a sufficiently high voltage rating.

set switched on to see if the crackles vanished. Obviously if they did, the crackles were due to some external cause. He returned the following day to say that he had tried all the various suggestions I had made but that the crackle continued, even with the aerial disconnected. I then diagnosed that he would probably find a frayed or corroded connection between the earth wire and the buried plate. This, in fact, proved to be the case. Major effects usually have minor causes.

I'm O.K.!

WILLIAM MORRISON (Banffshire) writes: "Perhaps it may interest you to know that although I have listened in for several years now, it was only last week that I heard a crooner, and it was a lady, too. Well, well! I am with you and wish to murder all crooners. I do not always agree with you but I do not take you too seriously. However, if you like the ladies, a dram, and a good story, you are O.K." I'm O.K.!

Requests from Colonial Readers

I FREQUENTLY receive letters from colonial readers asking for sets suitable for their local conditions. All of the



They switch on the wireless to listen—then do something else.

writers of these letters assure me that such a set would have a colossal demand overseas. In spite of these assurances, however, I am left stone-cold, by virtue of the fact that many of our receivers, particularly the all-wave receivers which have been specially designed for them, have only been made in the Mother country, whilst very few overseas readers have made them. I think my overseas friends overlook the fact that our receivers are designed around British-made components, which are not readily obtainable overseas; in some cases, of course, there would be an *ad valorem* duty which would render the cost prohibitive. Incidentally, quite a number of these readers when ordering parts from the Home Country do not always enclose sufficient for carriage, or for duty, with the inevitable result that manufacturers have to write for the additional money before the goods can be despatched. This occasions considerable delay.

I am not unmindful of the competition of the cheap American commercial receiver overseas. I am therefore all the more puzzled to know why readers should write on this topic when they do not assimilate the fare for which they ask when it is offered to them. Whenever we publish a design for a battery set there are the usual requests for D.C. sets, yet the numbers which are built are microscopical compared with the requests we receive.

Perhaps some of my more enlightened readers can tell me why? It is not encouraging to a designer to produce a design of interest only to a comparatively small proportion of his readers,

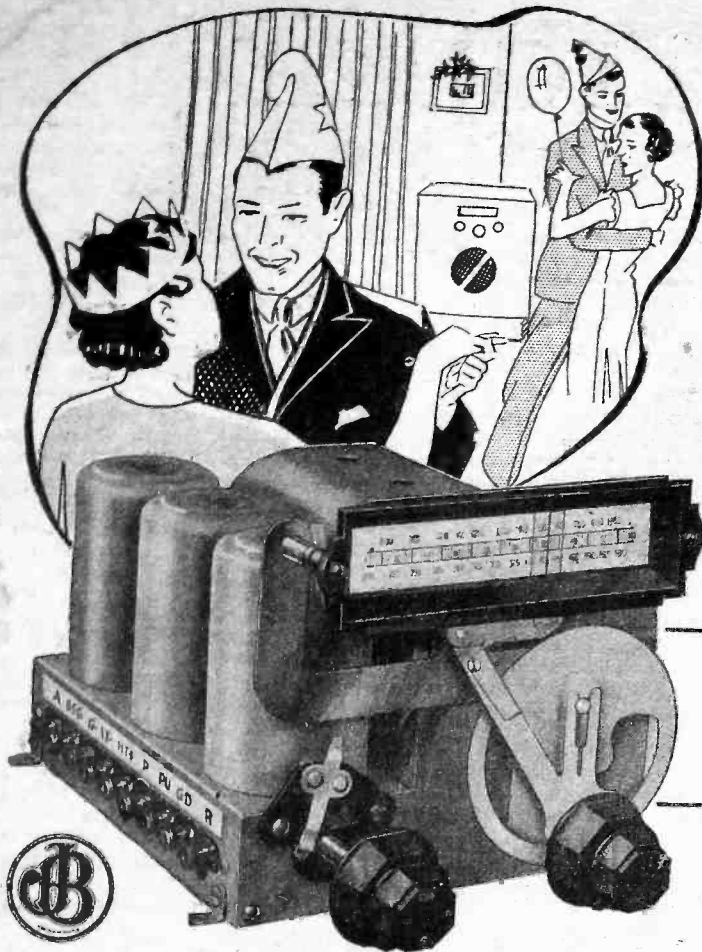

Let their experience be your **WISDOM**

Why not profit by the experience of these happy revellers?

They fitted a J.B. Linacore and now their three-year-old radio is actually like a brand new set.

A Linacore can do this for you and, with the help of our free blueprints, can easily be embodied in your set. It will put a new sparkle and realism into the most decrepit of radios.

Send for your Linacore now and get "all set" for the Christmas listening.

The Universal Linacore Tuner is suitable for use with either Battery or Mains Valves. Model B.P.U. Cat. No. 2129 **65/-**

Jackson Brothers (London), Ltd.,
72, St. Thomas Street, London, S.E.1
Telephone Hop 1837

Here's to better radio

Make this Christmas the turning point in your listening career. Modernise your radio set with the help of Varley components, we can probably put our finger on the weak spot in your radio. Please consult us. Our address is Bloomfield Road, Woolwich, S.E.18. Telephone: Woolwich 2345.



with Varley components

Trouble Tracking Made Easy—10

THE preceding articles have dealt with simple receiver tests, which can be conducted without the use of expensive instruments. It is probable, however, that many readers possess oscillators and A.C. meters, and it was therefore considered that this series would not be complete unless reference were made to the tests which can be conducted by means of these instruments.

The oscillator is actually a small transmitter, the output signal from which can be induced into the receiver so that the

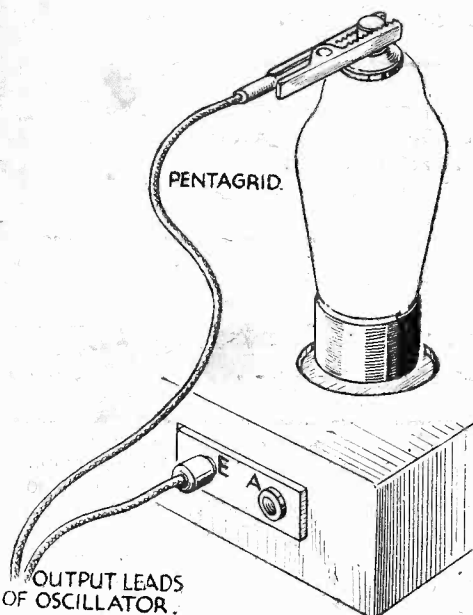

Fig. 1.—Showing a method of connecting the oscillator for adjusting intermediate frequency.

ganged circuits of the latter may accurately be trimmed, and the efficiency of the receiver measured.

Ganging Straight Sets

Although ganging a straight set is not a difficult procedure, it may be rendered still easier by the use of a calibrated oscillator, and the relative efficiency of the H.F. stages may be decided. In the first place, it is advisable to connect the output leads of the oscillator to the aerial and earth sockets of the sets, and then set the tuning control at approximately 300 metres. A signal should then be heard in the speaker when the oscillator control is set to 300 metres or harmonics thereof, and the receiver gang condenser trimmers may be adjusted until maximum volume is obtained. If no signal can be heard, however, the oscillator output lead should be transferred from the aerial terminal to the fixed vane terminal of the detector-tuning condenser. It is advisable to connect a condenser of approximately .0003 mfd. between the oscillator lead and the tuning condenser if a condenser is not already incorporated in the oscillator, as the detector condenser fixed vanes are at high potential in some receivers. If a signal is now heard it will indicate that there is a defect in the H.F. amplifying stages, and, therefore, the H.F.

Ganging by Means of an Oscillator, and Checking Output and Distortion by Means of an A.C. Voltmeter and a Milliammeter

By IDRIS EVANS

valves and their associated components should be tested. The relative efficiency of the H.F. stages can be decided by transferring the oscillator from the aerial terminal to the cap of the first H.F. valve, and thence to the cap of the second H.F. valve. The precaution of connecting a small condenser in series with the oscillator lead should be taken when this test is being conducted, otherwise a short-circuit of the H.T. supply and damage to the oscillator may occur.

Ganging a Superhet

It is more difficult to gang a superhet than a straight set, owing to the fact that an intermediate-frequency amplifier is incorporated; this generally contains four tuned circuits, which have to be accurately adjusted if optimum results are expected.

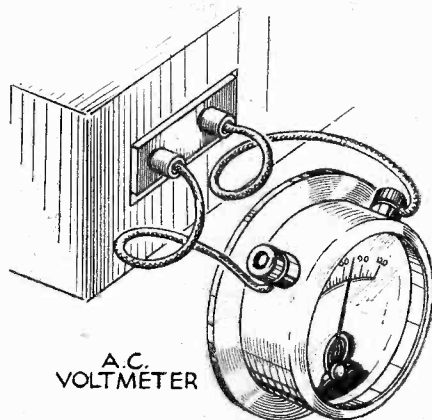

Fig. 2.—Checking the output by connecting an A.C. voltmeter to the extra L.S. sockets.

If signals are weak the ganging should be suspected, and in a superhet it is advisable to commence by checking the adjustment of the I.F. transformer trimmers. The two oscillator leads should be joined to earth terminal and the grid terminal of the frequency-changing valve respectively, as shown in Fig. 1, and the oscillator control rotated to the desired intermediate frequency. The trimmers of the I.F. transformers should then be adjusted until maximum volume is obtained. If no signals can be heard when the leads are joined to the frequency-changer, however, connection should be made to the cap of the I.F. valve (via a condenser) and then to the anode terminal of the frequency-changer. By this means the I.F. circuits can be checked separately, and the defective component localised.

After correct adjustment of the intermediate-frequency amplifier has been

effected, the oscillator lead should be transferred to the aerial terminal, and the gang condenser trimmers adjusted for maximum volume. A warning is considered necessary in connection with the trimming of modern superhets, however: if automatic-volume control is incorporated, it is necessary to disconnect the A.V.C. lead from the Westector or the diode of the D.D.T. valve, otherwise signal strength will remain constant over wide variations of the trimmer condensers owing to the effect of the automatic bias.

Measuring Output

Although it is possible to decide the efficiency of a receiver fairly accurately by aural means—that is, by listening to the strength of the signal from the speaker—a meter test is much more decisive. The voltmeter should be of the A.C. type and should be connected to the extra speaker sockets as shown in Fig. 2. Alternatively, the meter leads may be connected via 1-mfd. condensers to the terminals of the output transformer—this component is generally attached to the speaker. The series condensers are suggested in case the particular type of meter used does not have a transformer incorporated; it is necessary to prevent the direct current in the anode circuit of the output valve from passing through the A.C. meter. Extra speaker terminals are usually connected to the valve anode via a condenser, but if there is any doubt concerning the method of connection the above-mentioned series condensers should be fitted. By noting the meter reading, very accurate trimmer adjustment can be effected, and provided that the input level is maintained a comparative test of various types of sets may be made by this means.

Checking Distortion

Distortion is generally due to overloading of the output valve, but it has also been found that the detector valve often distorts. If distortion is experienced it is suggested that a milliammeter be connected in the anode circuit of the output valve; the easiest method of connection is generally between the valve anode and the primary winding of the output transformer. Except in the case of Q.P.P. and Class B valves the meter needle should remain reasonably steady at all volumes. Large variations indicate amplitude distortion; this may

(Continued on page 486)

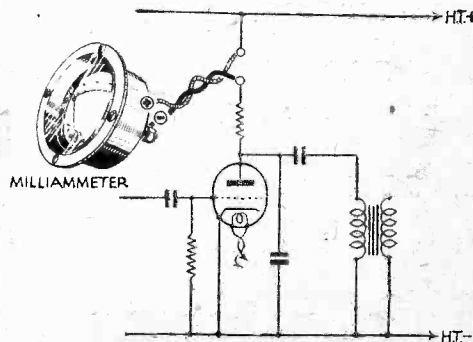

Fig. 3.—Checking detector anode current variation.

A PAGE OF PRACTICAL HINTS

SUBMIT YOUR IDEA

READERS WRINKLES

THE HALF-GUINEA PAGE

Making Moving-coil Cones Secure

THIS method can be applied to inner or outer centre fastenings of moving-coil cones. First get a tap screw long enough to master your two nuts and

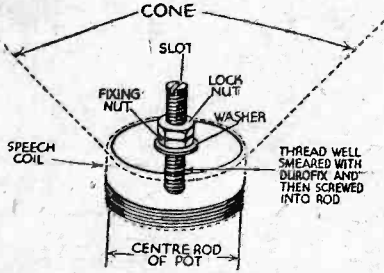

A method of making moving-coil cones secure.

washer, then cut the head off, and cut a slot in the top. Before screwing into pot centre apply a few drops of Durofix solution to tap hole in pot, then screw thread rod in tight and leave for an hour or so to set. Keep cone clear of any solution that may be on surface (if possible wipe it off). Then fix the cone, and with the lock-nut make a firm job.—R. EDWARDS (Cardiff).

An Accumulator Carrier

THE carrier shown below need never be removed from the battery. It has many useful purposes; the top terminals keep the leads clear of the battery, thus saving corrosion from spilt acid on the battery; the second set of terminals can be used for a hand lamp or other experimental purposes, and there is no need for removal when the battery is being charged.

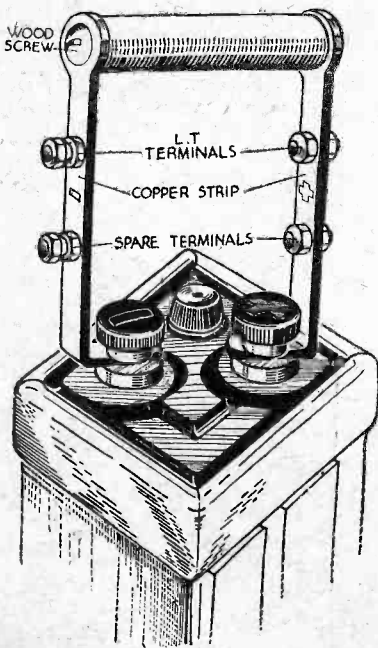

An accumulator carrier provided with terminals.

THAT DODGE OF YOURS!

Every Reader of "PRACTICAL AND AMATEUR WIRELESS" must have originated some little dodge which would interest other readers. Why not pass it on to us? We pay £1-10-0 for the best wrinkle submitted, and for every other item published on this page we will pay half-a-guinea. Turn that idea of yours to account by sending it in to us addressed to the Editor, "PRACTICAL AND AMATEUR WIRELESS," George Newnes, Ltd., 8-11, Southampton Street, Strand, W.C.2. Put your name and address on every item. Please note that every notion sent in must be original. Mark envelopes "Radio Wrinkles." Do NOT enclose Queries with your Wrinkle.

The handle is made of hard wood or other non-conducting material, and the upright strips are of copper or brass plate. If these strips are used it is best to turn in the edges to make them more rigid. I have not specified any sizes, as it can be made according to the requirements of the user. A good tip is to paint the strips, one red, the other black, but make sure the paint is kept clear of terminals.—J. HALLIDAY (Aberdeen).

A Good "Mike" Substitute

THE following material is required for the construction of this efficient yet simple model. One piece of conduit A (approximately 1/2 in. diameter, length to suit requirements); one piece of conduit B. This is to be slit to allow the part A to telescope into it, as shown in the sketch.

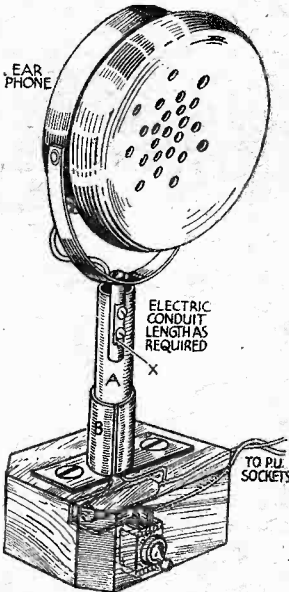

An efficient improvised microphone.

an old earphone is also required which is fixed in the manner indicated after filing the surface X to allow same to be drilled to take two 6BA screws and nuts. The screws are put straight through the conduit which is also drilled with a 6 BA clearance at the appropriate point. The base fitting is self-explanatory, the fixed condenser housed in same being for tonal effect. The value should be in the neighbourhood of from .0005 to .001 mfd. Reproduction with this "mike" is very good when it is kept at approximately three yards from a musical instrument, and about 1ft. or so from the announcer.—W. R. HOBBS (Ilford).

An Eliminator Switch

HERE is a very simple but effective switching device for changing an eliminator with toggle switch to trickle-charger without requiring to take off back from set, etc. A strip of brass or any other metal 1/2 in. wide, a strip of thick leather or fibre, 1 1/2 in. by 1/2 in., the end of a hack-saw

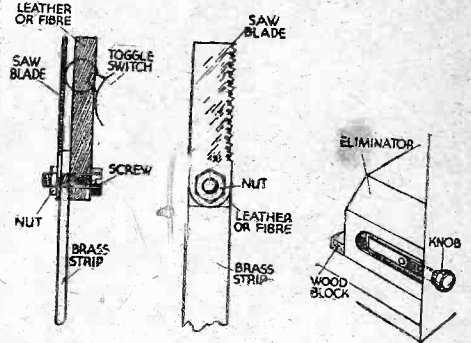

An effective eliminator switch.

blade about 1 1/2 in. long, also a small nut and screw, are required.

Firstly, a hole should be made in one end of leather or fibre, just big enough to slip over knob of toggle switch. A hole should now be made in one end of metal strip, also in other end of leather. These parts are then screwed together, as shown in sketch; washers may be used if necessary. The other end of metal strip is pushed through a slot in side of cabinet at correct position; the end may be turned over and a knob screwed on if desired. To keep the eliminator from moving a little block of wood should be glued in.—D. B. B. MACKINNON (Glasgow).

H.T.-L.T. Switching

HERE is an idea of mine which I am at present using successfully. I have no worry about the H.T. being switched on before the L.T., as the combined switch makes that impossible. The drawing makes all details quite clear.—J. J. LYONS (Llandudno).

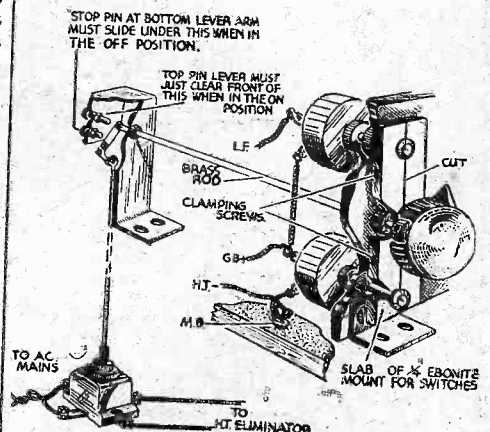

An H.T. and L.T. switching arrangement.

It would seem necessary, in view of the many articles which have been published on this subject, to make an apology for again giving instructions on how to make a simple test-set by means of which it is possible to take accurate measurements of the current and voltage readings in a modern radio receiver, but I would wish the reader to bear in mind that the unit described in this article is intended as a nucleus, around which it will be possible, through the medium of subsequent articles to form a complete laboratory equipment of test apparatus. Moreover, the construction is not outside the capability of the average amateur, or service engineer, as access to precision instruments for calibration purposes is not required. In short,

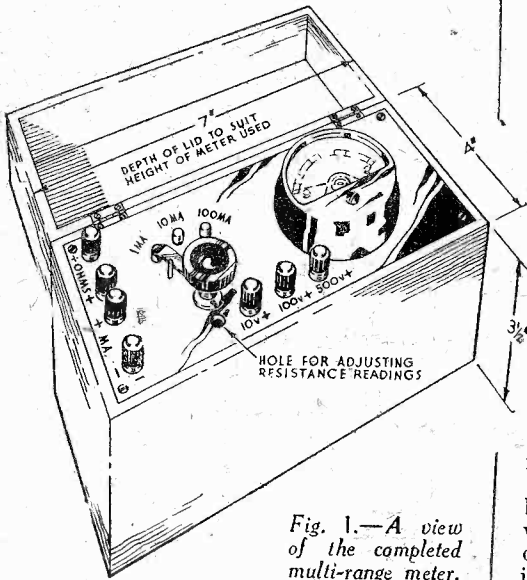

Fig. 1.—A view of the completed multi-range meter.

the necessary series resistances and shunts can be chosen, or made at home with the aid of the instrument with which they are to be used, and the simple calibrating apparatus shown. I would add, moreover, that this latter calibrating apparatus will be used as part of the instrument later to

extend further its usefulness, so that even if you have not these parts by you, their purchase price will not be wasted.

The parts required are given herewith.

Calibrating Apparatus

The first step is to set up the calibrating apparatus, and make the shunt resistances for extending the milliamp scale to 10 m. A. and 100 m. A. First, connect up the meter, dry battery, switch and 5,000 ohms variable resistance, as shown in Fig. 2, taking care that the resistance is set so that all the element is in circuit. The meter will then be found to give, with the switch in the "on" position, a deflection somewhat less than full scale. Decrease the variable resistance until 1 m. A. is accurately indicated on the scale, then bare the ends of the 2yds. of 30 gauge D.S.C. "Eureka" wire and attach these two bared ends across the clips. The reading of the milliammeter will then drop to a value just above .1 m. A. The "Eureka" wire must then gradually be shortened, testing across the clips every inch or so, until 1 m. A. is indicated accurately. It is the wisest plan to check that the meter still reads 1 m. A., when the wire is removed from the clips; if it does not, re-adjust the variable resistance.

When the correct length of wire has been found, double it back on itself and wind it on one of the small wooden spools or ebonite rods, securing the ends with a binding of thread. The whole shunt may then be given a coat of shellac or immersed in hot paraffin wax, and allowed to drain and dry. If the internal resistance of the meter is exactly 100 ohms, the value of the shunt just described will be 11.1 ohms.

A little extra care must be taken when calibrating the 100 m. A. range, and the switch must be opened every time the resistance wire is removed from the clips for adjustment. The procedure is as follows:—Connect the resistance we have just made to the clips, then decrease the variable resistance until the meter indicates 1 m. A., open the switch and remove this resistance from the clips and replace it with 2yds. of

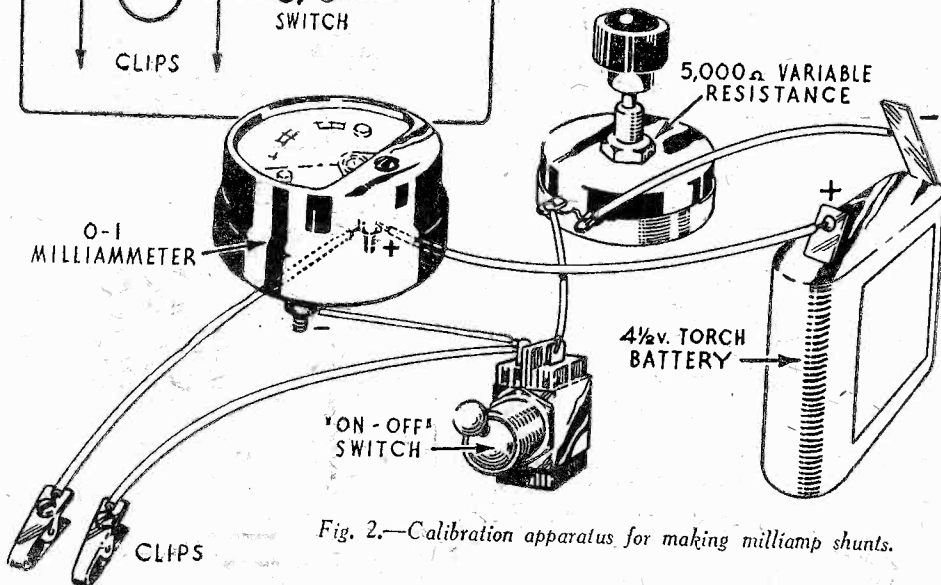
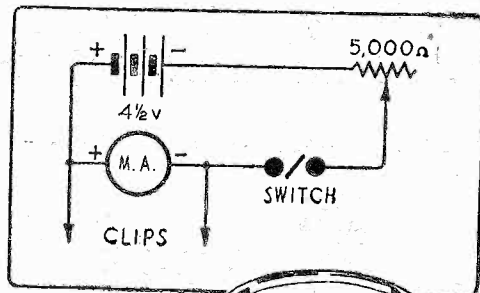

Fig. 2.—Calibration apparatus for making milliamp shunts.



In this First A

No. 20 S.W.G. "Eureka" wire, switch on and the reading of the meter

should be just about .1 m. A. Now switch off and shorten the wire, testing inch by inch, taking care to switch off every time the wire is removed for adjustment, until .1 m. A. is accurately indicated. Finish off the resistance as previously, and you will have the two shunts extending the milliamp ranges to 10 m. A. for the first shunt and 100 m. A. for the second.

Now re-arrange the calibration circuit as shown in Fig. 3, and short-circuit the clips,

set the variable resistance "all-in," close the switch, and reduce the variable resistance until the meter reads 1 m. A. Now open the clips and insert the 10,000 ohms composition resistance; the reading should now be .1 m. A. If it is not, you will probably be able to find amongst your stock a resistance of a nominal value of 10,000 ohms which is sufficiently low to make the meter give an accurate deflection of .1 m. A. If an amateur, your local retailer will probably allow you to run through his stock of resistances to find one which will give the desired result. As an alternative, you may find it possible to remove the outer enamel of the resistance with a penknife at one end, and carefully scrape the resistance coating itself until the desired deflection is obtained. This will be the series resistance for the 10-volt range which is used to calibrate the remaining two voltage ranges.

Final Ranges

To obtain the next range, connect the 10,000-ohm resistance in series with the milliammeter and across a source of voltage, say 9 volts, from a high-

- PARTS REQUIRED RANGE**
- One Moving-Coil reading 0-1 m. A. (In 100 ohms.)
 - One Three-way switch contacts.
 - One Ebonite Panel 7
 - One Box with hinged Seven Terminals.
 - One Resistance (fixed)
 - One Resistance (fixed)
 - One Resistance (fixed)
 - All the above re composition type described in the
 - Two yards 30 gauge
 - Two yards 20 gauge
 - Two small wooden spools or ebonite rod.
 - One Resistance (variable-wound).
 - One "On-off" Switch
 - One 4.5-volt Flash-lamp

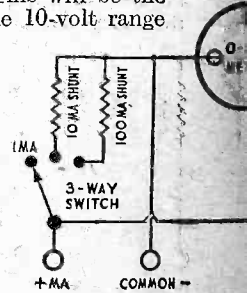

Fig. 5.—Theoretical circuit

ING SETS FOR PROFIT

THE EXPERIMENTER

of the Series, an Easily Constructed D.C. Multi-range Volt and Milliammeter is Described

ension battery. If the battery is in a good condition, and it should be for calibration purposes, the meter will read .9 m.A. disconnect the 10,000 ohms resistance and substitute the 100,000 ohms resistance. The reading of milliammeter should now be .09 m.A., or one-tenth of the previous reading, whatever that may have been. If it does not, find a 100,000 ohms resistance which will give the necessary fall in percent.

For the final 500-volt range, leave the 10,000 ohms resistance connected, but increase the voltage applied until a reading of .9 m.A. is again obtained, i.e., 90 volts. Now substitute the 500,000 ohms resistance and, if this is suitable, the meter will indicate .18 m.A., or one-fifth of the previous reading. Select a resistance which will give this result, and this will be the correct series resistance for the 500-volt range.

FOR MULTI-RANGE

meter—full-scale resistance approx.

low resistance

Fig. 1).

ohms (1 watt).

ohms (1 watt).

ohms (1 watt).

to be of the

to be selected as

"D.S.C. wire.

"lengths of 1/2 in.

5,000 ohms

ery.

er.

er.

er.

er.

er.

er.

er.

er.

er.

er.

er.

er.

er.

er.

er.

er.

found no difficulty in reading direct from the existing meter scale by multiplying the figures indicated by the pointer by the full scale reading of the range in use. For instance, when on the 10-volt range a reading of .6 m.A., equals 6 volts (i.e., .6 x 10), when on the 500-volt range a reading of .4 m.A. equals 200 volts (i.e., .4 x 500). and when on the 100 m.a. range a reading of .5 m.A. equals 50 m.A. (i.e., .5 x 100).

It should be emphasised that if the manufacture of the resistances has been carefully carried out, the joints well soldered when wiring

meter itself, and the better the meter the higher the all-round accuracy obtainable.

In a subsequent article it will be explained how this instrument may be adapted for use as a direct-reading ohmmeter, giving accurate measurement of resistance for 500-50,000 ohms, by the insertion of the battery and variable resistance which have already been used to calibrate the various ranges. Space for this addition has been provided in the box, and the necessary terminals and means of access for adjusting the variable resistance are shown. If this addition is not required, however, the meter may be assembled as a complete unit, and will be found a useful adjunct to any amateur's or service-man's equipment.

In addition to the above conversion to an ohm-meter, a unit has been designed to attach to the instrument described herein, to enable direct readings of alternating voltage to be made. This will be also described later.

In comparing the cost of this multi-

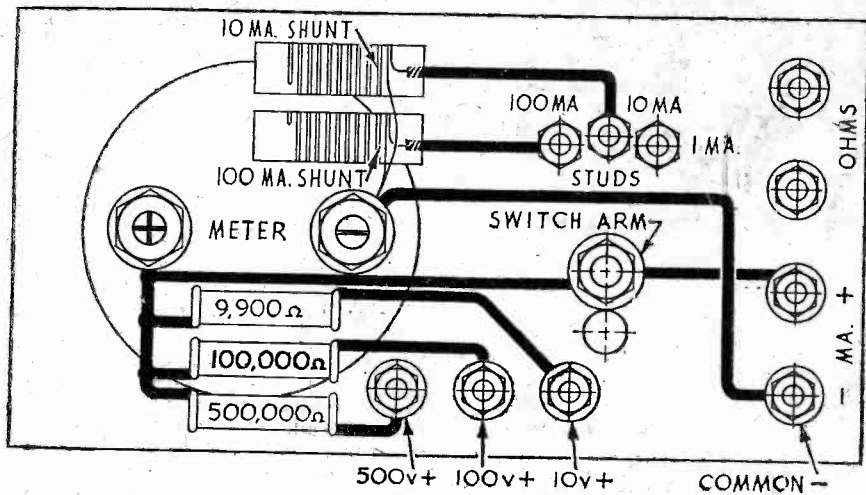
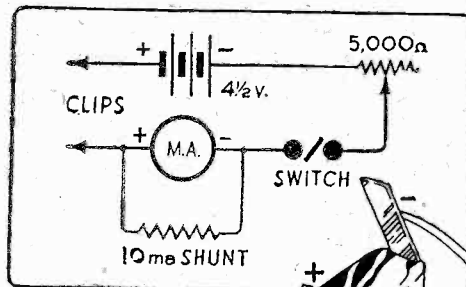

Fig. 4.—Back of panel wiring diagram.

up, and the contacts of the switch are of low resistance, the accuracy of the complete instrument will be of the same order as the



range meter with a commercial model of the same order of accuracy, a saving of a pound or two is immediately apparent, as a suitable meter of B.S.I. accuracy, and low internal resistance may be obtained from advertisers in this journal for as little as 18s. 6d., making the total cost of the instrument in the region of 30s., complete.

Fig. 3.—Calibration apparatus for increasing voltage ranges.

Assembly and Wiring

What remains is to fit the meter, switch, and associated resistances on to the panel and wire them up as shown in Fig. 4. This should need no detailed explanation, especially if reference is made to the theoretical circuit in Fig. 5, and no difficulty should be experienced in assembling the meter if it is remembered to set the switch always to 1 m.A. before taking voltage readings, and to be careful to select the correct ranges when making measurements.

With regard to the scale, you may be able to inscribe an actual calibration for each range, but I have

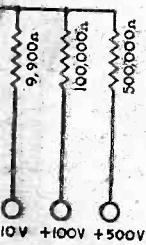

of the unit.

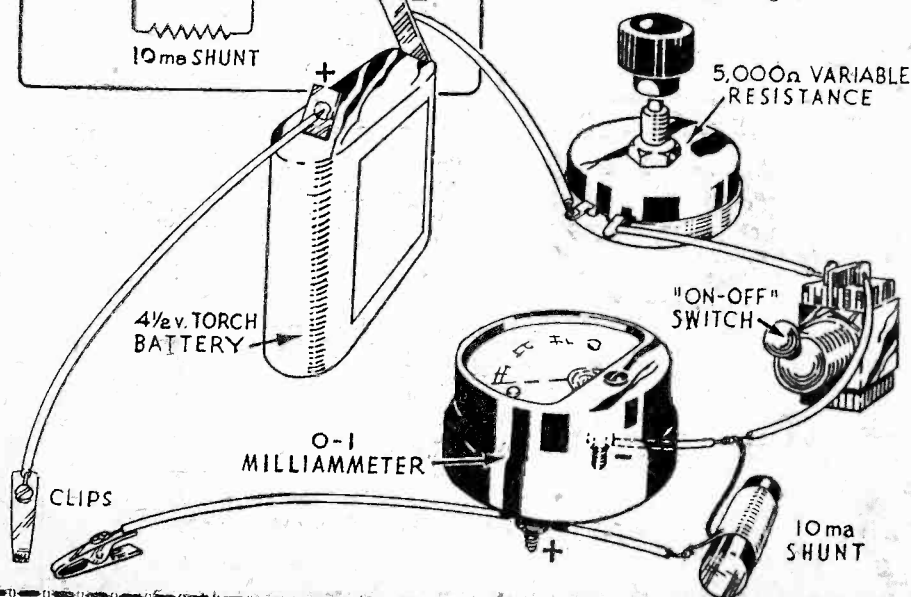

INTRODUCING The UNIVERSAL £4 SUPERHET 4

Circuit Details of the A.C./D.C. Version of the Popular £4 Superhet 4

HUNDREDS of reports from all parts of the country indicate that the £4 Superhet 4 has proved to be a great success. After the warm approval accorded to last year's superhet—the £5 Superhet—we realised that thousands of our readers were superhet-minded, but even so the interest taken in this year's models has exceeded our expectations. It is evident from our correspondence, however, that although the battery and A.C. versions meet with the requirements of most of our readers, there are many who have a D.C. mains supply or are likely to move to a D.C. locality in the near future, and therefore require an A.C./D.C. model; others want a de-luxe version of the battery model, incorporating automatic volume control, tone control, and tuning indication. We would assure these readers who are in the latter class that their requirements were anticipated when the battery version was designed, and the addition of the desired refinements will not be a difficult matter; details of the de-luxe battery version will be published in the near future.

A.C./D.C. Version

For the present, however, we will confine

our attention to the A.C./D.C. model, a theoretical diagram of which will be found on this page. The design of A.C./D.C. receivers—or universal receivers as they are commonly called—presents more difficulties than that of battery and A.C. sets. We have experimented extensively with the A.C./D.C. type of set, however, and have produced two very efficient receivers during the past twelve months—viz., the Universal £5 Superhet and the Universal Hall-mark Four. Readers can therefore rest assured that our latest receiver will do all that is claimed for it.

Circuit Arrangement

A study of the theoretical diagram will indicate that the design closely follows that of the A.C. model. In the interests of readers who are likely to suffer from morse interference band-pass pre-selector coupling has been retained, although in most cases the first tuned circuit need not be made use of, and a higher degree of sensitivity will be obtained by connecting the aerial lead to aerial terminal A2. One of the latest types of pentagrid frequency-changers is used in conjunction with a highly efficient I.F. amplifying valve. These

valves are followed by a power-grid detector, as it is our belief that the majority of our readers prefer a simple detector of this type to the more complicated multiple valve type; constructors are assured that a well-designed power-grid detector is capable of practically distortionless rectification. As the output valve is of the high-efficiency pentode type, it was decided to precede this with resistance-capacity coupling in preference to an L.F. transformer; it is our experience that a mains-operated power-grid detector can fully load a pentode without the use of transformer coupling.

The rectifier is of the indirectly-heated type, and as will be noted, is connected on the half-wave principle. When an A.C. mains supply is used, the valve then acts as a half-wave rectifier, whereas with D.C. supplies it merely acts as a resistance. The voltage drop across the rectifier when a D.C. supply is used is negligible, however; it only amounts to approximately 15 volts. Further details will be given next week, but in the meantime readers who are acquainted with theoretical diagrams can commence constructional work in complete confidence.

Theoretical Circuit of the Universal £4 Superhet 4

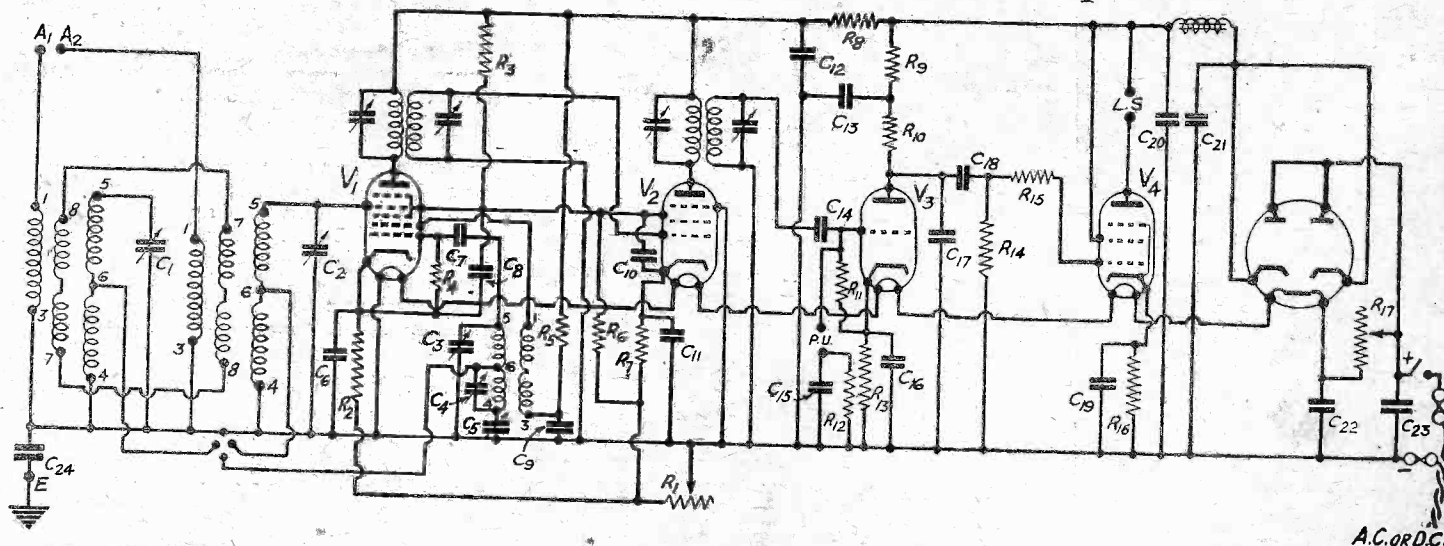

TROUBLE TRACKING

(Continued from page 482)

be cured by fitting an output valve having a higher undistorted output rating, or by increasing the anode voltage on the existing valve if this is permissible.

Most home-constructed receivers employ a power grid detector, and although it is possible to obtain practically distortionless rectification with this type of detector, it is necessary to choose the correct type of valve, and the design of the input and output circuits must be correct. A milliammeter is very useful for checking the efficiency of this type of detector stage; the method of connection is shown in Fig. 3. In order to obtain distortionless rectification the anode current should be approximately 7 m.A., when no signal is being received, and should

decrease by approximately 1 m.A. when a signal is tuned in. If a deflection of approximately 1 m.A. cannot be obtained it will indicate that the H.F. amplification is insufficient. If, on the other hand, the output valve is overloaded before the deflection reaches 1 m.A., excessive L.F. amplification is indicated and an L.F. volume or a larger output valve (as mentioned above) should be fitted. A milliammeter connected in this manner can be used for tuning indication.

A.V.C.

If there is any doubt concerning the effectiveness of the automatic volume control device, it is suggested that a milliammeter be connected in the anode circuit of the controlled valve (or valves). If the A.V.C. is functioning effectively,

a marked reduction of current consumption should be indicated when a strong carrier is being received.

PROGRAMME NOTE

Studio Variety from Manchester

UNDER the title "Snacks" a special variety bill will be broadcast from the Manchester studios on January 2nd. Details are not yet available, but the bill will include Dorothy, the well-known Liverpool mezzo-soprano, who is to sing songs by Alan Low, also of Liverpool, who will accompany her on the piano. The programme is being arranged by Arthur Spencer.

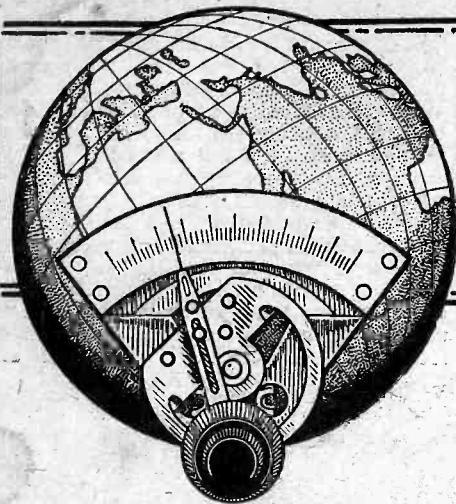

SHORT WAVE SECTION

CAUSES AND PREVENTION OF DEAD SPOTS

Methods of Overcoming Trouble Due to the Receiver being Less Sensitive at Certain Settings of the Tuning Condenser are Described.

SO-CALLED dead spots in the tuning range of a short-wave receiver should not exist if the set is correctly designed, and provided that all components are of correct value. Nevertheless, the fact remains that they are often in evidence despite careful design and assembly, and in many cases they can only be prevented from spoiling the receiver by experimenting with a few different arrangements.

What are Dead Spots?

In case there are some readers who are new to the short waves it might be explained that dead spots is the name given to those portions of the tuning range over which signals cannot be received, or where signal strength is much lower than at other wavelength settings. It is not uncommon to find, after completing a new set, that above and below certain wavelengths the receiver functions perfectly well, although somewhere between the two extremes it seems to be lifeless. Generally, it is found that over a narrow band the reaction control has little effect; even if the detector can be made to oscillate at all, it is necessary to advance the reaction control well beyond its normal position.

The Simplest Remedy

The trouble is most often met when using a set of the detector-L.F. type, although it is not always absent even when an H.F. amplifier is incorporated, or when the set is of the superhet type. In the simplest type of instrument, the trouble can often be overcome completely by using a different aerial—a shorter length of wire generally produces the desired effect. The reason for this is that the aerial-earth circuit tunes to a "natural" frequency or wavelength of its own, and conditions may be such that the tuned circuit acts as a form of wave-trap. By altering the constants of the circuit the "natural" wavelength is altered so that it is different from any of the wavelengths to which the receiver tunes.

It will be understood from this that an alteration to the earth lead may have the same effect as changing the aerial. If the lead is more than a few yards in length shortening the wire will often provide a complete remedy. It is also worth mentioning, in passing, that when a long earth lead must of necessity be employed, the wire should be insulated, since it forms an important part of the complete aerial-earth system.

A Variable Series Condenser

A similar effect to that obtained by changing the characteristics of the aerial or earth can be obtained by including a

condenser in series with the aerial lead-in, and if a variable condenser is used the "natural" frequency can be adjusted between fairly wide limits. This means that if, when a dead spot is reached during the tuning process, its effect can be eliminated by altering the capacity of the condenser. A pre-set condenser can be used, as it is in a broadcast receiver for the purpose of improving selectivity, but it is far better to use a fully-variable condenser of the air-dielectric type and with a maximum capacity of about .0001 mfd. for wavelengths down to about 20 metres, or of half this capacity for still-lower wavelengths. The condenser should be mounted on the panel and the fixed vanes should be connected to the aerial terminal. The condenser is sometimes rather more useful when screened, but in most cases screening has the effect of reducing sensitivity by increasing the fixed aerial-to-earth capacity.

reaction condenser of comparatively high capacity. Thus, where a .00016-mfd. condenser is used for tuning, a .0002-mfd. component may be required for reaction.

Whilst referring to the reaction circuit, which is really a portion of the complete anode circuit of the detector valve, it is worth mentioning that the high-frequency choke can have a pronounced effect on the presence or otherwise of dead spots, for if this component is of too low an inductive value, or if the self capacity is comparatively high, it might be so ineffective at certain frequencies that it does not act as a "stopper," as it should, but permits the passage of H.F. currents into the high-tension circuit. Trouble need never exist in this respect if constructors make use of the correct type of choke recommended for any particular purpose by the makers of reputable components.

Look to the Grid Condenser

It is often overlooked that the grid condenser and leak may be the cause of dead spots if they are of unsuitable value. In nearly every case it will be found that a .0001-mfd. condenser and 3- to 5-megohm leak are perfectly satisfactory, but if trouble persists after checking the other parts of the set it is worth while to try a pre-set condenser of about .00015-mfd. maximum capacity, and to experiment with various settings of this.

The troubles mentioned above may occur when using a tuned high-frequency stage, although this is unlikely. If they do, the same remedies can be applied, but alternatively, all difficulty is almost sure to vanish if the first valve is untuned, a good short-wave H.F. choke or a 100,000-ohm non-inductive fixed resistance being wired between the aerial and earth terminals in place of the tuning coil and condenser. No matter whether the H.F. valve is tuned or not it will give only a slight degree of amplification, and so the difference is practically negligible.

Dead Spots with a Superhet

When using a superhet receiver the trouble may be more difficult to overcome, but if a triode or S.G. type of valve is used as autodyne frequency changer all of the points mentioned above are applicable. When using a pentagrid, alterations to the aerial circuit should be tried first of all, but it might be found desirable to increase the voltage applied to the anode of the oscillator section, whilst an improvement can sometimes be effected by varying the intermediate frequency by the simple process of adjusting the trimmers of the I.F. transformers. In other cases, an appreciable improvement can be observed by varying the voltage applied to the screening grids or by decoupling the H.T. supply to these by inserting a 10,000-ohm fixed resistance and by-passing it with a .1-mfd. fixed condenser.

NEWNES' TELEVISION AND SHORT-WAVE HANDBOOK

2nd. Edition

By F. J. CAMM.

Price 3/6 or 3/10 by post from the Publishing Dept., Geo. Newnes, Ltd., 8-11, Southampton St., Strand, London, W.C.2.

The same effect as that obtained by using the condenser can be obtained by using a separate and untuned aerial coil variably coupled to the grid coil; a dead spot can then nearly always be eliminated by altering the position of the aerial winding. This method is not normally very convenient, however, for it is not an easy matter to mount a moving coil so that it can be moved smoothly by means of a control on the front of the set.

The Reaction Circuit

In very many cases, dead spots are due to the fact that the proportionate numbers of turns on the tuned (grid) winding and on the reaction coils are unsuitable. Some designers of coils use a greater number of turns on the reaction winding than on the grid winding, with the result that the reaction circuit is often inclined to "take charge" of the tuning; the usual result is that reaction adjustments affect the tuning and that dead spots are introduced. Because of this it is always "safer," and generally better, to have a coil whose reaction winding has about three-quarters of the number of turns used in the grid circuit. It should be remembered, however, that this makes it necessary to have a

Facts and Figures

COMPONENTS TESTED IN OUR NEW LABORATORY

"Philco Serviceman"

SOME very useful instructions on accurate dial scale settings and details for making a handy shadow-tuning indicator screen, are given in the latest service manual of the Philco Company. In addition, there is an announcement of a new Philco combined set tester and all-wave signal generator which employs the original 025 circuit tester together with a new all-wave signal generator Model 088. The complete outfit costs 15 guineas with strong wooden carrying case, and there is a special price reduction for Philco dealers and R.M.S. members.

New High-voltage Low-current Rectifier

THE forthcoming use of cathode-ray tubes for television and similar purposes has led to the demand for a special rectifier for the provision of the accelerator voltage. The new Osram valve, which is illustrated on this page, is designed for this purpose, and is of the directly-heated type with an oxide-coated filament and an anode in the form of a flat cylindrical disc, mounted on two long glass support rods from the pinch. This method of construction is necessitated owing to the high voltage which is employed, and the anode connection itself is taken to a standard cap on the top of the bulb. The standard 4-pin base is fitted, but only the two filament pins are employed for connection purposes.

The U16 is made with a filament rating of 2 volts .25 amp., and is capable of withstanding an anode voltage up to 5,000 max. P.M.S. with a rectified current of 2 milliamps D.C. This is adequate for the usual type of high-voltage cathode-ray tube as used for television purposes, and the smoothing circuit normally consists of a resistance of approximately 100,000 ohms in conjunction with two condensers of 0.25 microfarad. The first of these condensers must, of course, be suitable to withstand the required peak voltage.

It is advisable to incorporate some form of fuse in the output circuit to safeguard the valve in the event of condenser breakdown. The method of arranging the windings of the mains transformer should be noted, the inner end of the high-tension winding (positive) being earthed. This earthing of the positive H.T. supply is quite normal in the use of cathode ray tubes.

The list price of the Osram U16 valve is 20s.

Bulgin 4-Range Coils

A NEW type of coil has been introduced by Messrs. Bulgin, and this is designed for use on the broadcast as well as the short-wave bands. The coils are entirely enclosed, and fitted with a bakelite base, beneath which soldering lugs and connecting sockets are provided. It is thus necessary to bring out the connecting leads beneath a chassis and so the coils lend themselves admirably to the method of receiver building which has been standardised by us, namely, chassis construction. To avoid difficulties in connection with the lead to the anode of the H.F. valve a flexible lead is brought out at the top of the anode coil and an insulated grummet is fitted to prevent troubles due to short-circuiting. The windings have been split and divided between the two cans, and the wave-ranges covered are from 15 to 35 metres; from 30 to 85 metres; from 200 to 550 metres, and from 1,000 to 2,100 metres.

In order that the high efficiency of the winding system may be preserved it is essential that a good low-loss type of multi-contact switch be employed, and in this connection a special switch has been produced by Messrs. Bulgin, and is shown with the two coils. The number of contacts on this switch permit also of pick-up switching, or some similar operation, and readers will remember that this type of switch was fitted to our Superformer receiver. Any number of units may be ganged and operated from the same spindle, and each unit consists of a two-pole element with five circuiting positions. The drive and special locator element (which ensures that the contacts are brought each time into the correct position for switching) costs 2s. 9d., complete with a six-inch shaft. It may also be obtained with a 9 or 12-inch shaft at slightly increased cost. The switch element, known as a contact unit, with bracket for baseboard mounting costs 2s. 9d., and without the bracket it costs 2s. 6d. Thus, a complete unit consisting of drive, locator, and two switch sections would cost 8s., complete, with one bracket for mounting purposes.

The coils above referred to cost 8s. 9d. each, type C52 being used as an aerial coil and type C53 as an oscillator coil. Special intermediate-frequency transformers are available for use with these coils and will be reviewed in a later issue.

New Cosmocord Pick-up

A NEW design of the famous Cosmocord pick-up has now been introduced, and is shown on this page. This component is designed for use with any type of tone-arm or pick-up carrier, and costs 5s. A test report will be published at a later date.

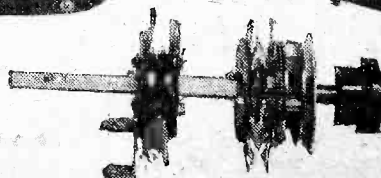
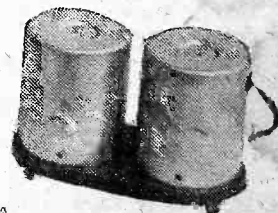
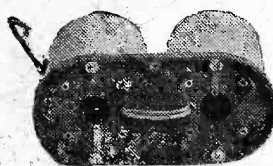

The Bulgin Types C52 & C53 coils and the low-loss switch which is recommended for use with these coils.

Bennett Television Converter

THE user of a broadcast receiver is often in doubt as to the most suitable type of unit to be employed for short-wave reception. Where no H.F. stages are employed there is, of course, only the possibility of employing the simple adapter, but when H.F. stages are fitted to the broadcast receiver there are the two alternatives of using a converter or an adapter. Whilst the former gives the better performance from the point of view of range of reception, some constructors prefer an adapter, to avoid background noises when listening to a station under adverse conditions, or for specialised reception. Furthermore, although an



A new pick-up unit introduced by Cosmocord.

existing receiver may employ no H.F. stages there is always the possibility that at some future date a new set may be constructed in which such amplification will be employed, and a simple adapter will then be only of partial use. There is, therefore, a good deal to be said in favour of a unit constructed as a combined converter-adapter so that it may be employed in either way, and a very useful and efficient unit of this type is obtainable from Bennett Television Co., of Redhill. This particular unit is also of universal application in that it may be employed with battery or mains-operated receivers, and the price is only 30s. It employs all the modern refinements, which are so desirable in efficient short-wave working, and may be relied upon to give a high performance with any type of broadcast receiver. Some special short-wave kits may also be obtained from the same firm at prices ranging from 20s.

LEAVES FROM A SHORT-WAVE LOG

New Year Transmissions

CHRISTMAS this year will have brought to the broadcast listener, as usual, through the medium of the B.B.C. and also Continental radio organisations, such a plethora of transmissions that possibly during these holidays the short-wave receiver may have been temporarily forsaken. On the other hand, it must be borne in mind that on the higher frequencies there has been, and will still be, a large number of interesting broadcasts which are not available to the man who possesses only a medium- and long-wave set. In consequence, if a tour of the world is proposed, nothing could be better than to settle down on December 31st to an all-night sitting—an easy opportunity to take in most households on this occasion—and hear for yourself how the New Year is celebrated in various quarters of the earth.

In addition to a number of foreign broadcasters such as Berlin, Paris, Rome, Budapest, Copenhagen, Oslo, and so on, care must be taken not to forget the U.S.A. Schenectady, Pittsburgh, Boston and Bound Brook transmitters which, on behalf of the N.B.C., will be working at high pressure. This U.S.A. organisation is staging this year an all-star programme, inasmuch as in the course of thirteen hours it will take you on a conducted tour through five continents. Starting at G.M.T. 15.00 you will visit Tokio (Japan) as the clocks chime out the midnight hour, then at 17.00 Manila (P.I.), Batavia (Java) or Bangkok (Siam), then ninety minutes later Bombay, and at 21.00 Moscow, whence the Kremlin carillon, playing the Internationale should be heard. At G.M.T. 22.00, relays are to be carried out from Central European countries such as Finland, Italy, Germany, or Austria, and at midnight we shall be switched over to London, as in previous years.

Through the medium of the new Reykjavik short-wave station, New York also hopes to secure a message from Iceland at G.M.T. 01.00.

For another hour you will be able to roam the ether to your heart's content, but should make a point of returning to New York just before G.M.T. 02.00, when the N.B.C. plans to get into touch with one of the transatlantic liners then somewhere in the neighbourhood of the Azores, on its way to Europe. At 03.00, listeners will be transported to Rio de Janeiro, and after a short spell, with an interval in the New York studio, to Buenos Aires, when greetings between the two Republics are to be exchanged.

Finally, at 05.00, North America will conclude its New Year festivities with a special entertainment, linking up all transmitters in the N.B.C. network.

Australian Broadcasts

For listeners who are able to tune in broadcasts from Sydney, Lyndhurst or Melbourne, note should be made that these stations will transmit extra programmes in the period December 26-30th. The schedule is as follows: VK3ME, Melbourne, 31.55 metres (9,510 kc/s), December 26th; VK2ME, Sydney (N.S.W.), 31.28 metres (9,590 kc/s), December 29th; VK3LR, Lyndhurst, 31.32 metres (9,580 kc/s), December 30th. All broadcasts will be made between G.M.T. 11.45-12.15.

CAPSTAN CIGARETTES
PLAIN OR CORK TIPPED

10 for 6d.
20 for 11½d.

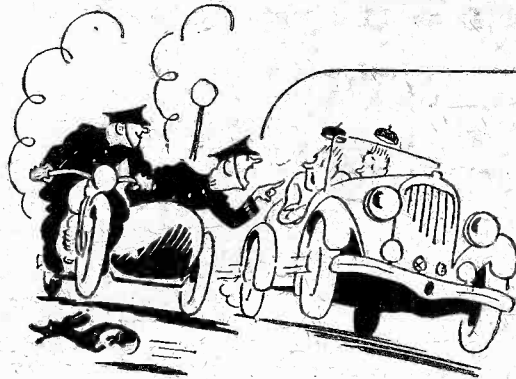

*As the "Speed-Cop"
said to his victim:*

BETTER BUY CAPSTAN.

they're blended better

-they're Wills's!



LETTERS FROM READERS

The Editor does not necessarily agree with opinions expressed by his correspondents.



All letters must be accompanied by the name and address of the sender (not necessarily for publication).

G6GV Replies!

SIR,—Your correspondent, Mr. A. W. Mann, of Middlesbrough, has, so far, in his lengthy articles on British 40-metre high-power QRM, etc., made no reference whatever to Skip Effect.

I am surprised that Mr. Mann and his learned and experienced friends have evidently not listened on this band when the Skip Effect has been in evidence, otherwise I am sure they would have realised the inadvisability of making a sweeping charge against British high-power transmitters of "jamming the low-power station out of existence."

It is often impossible to hear any but local G stations except an occasional weak ground-wave from some high-power amateur transmitter. Therefore, as I thought Mr. Mann would understand in my previous letter, all that needs to be considered from a British standpoint is local QRM and, as it is a comparatively rare occurrence to find a number of transmitters all using high-power within a short distance of one another, the question from a general viewpoint becomes unimportant.

If, on the other hand, Mr. Mann has some knowledge of 40-metre reflection and skip, one naturally assumes that he is championing the cause of the Continental Hams, a number of whom inflict on listeners on this band what is now known as "Spitch." His criticisms, therefore, should not be directed to the R.S.G.B., but to those in charge of these transmitters who swamp the 40-metre band and who cannot be received clearly from a distance except by expensive crystal-filter superhets.

I hope your correspondent now sees that, as I inferred in my previous letter, local co-operation is the accepted cure for high-power G QRM, except for those infrequent periods when stations from all over the country can be heard, and even distant low-power G stations (if one can be permitted to use the word distant with regard to Europe) come in at R9. The remedy then, of course, is the possession of a single-signal receiver.

If the question were really serious, one would naturally assume that the complaints would come from those most concerned, viz., the low-power operators and not the lookers-on who are alleged to see most of the game, but who evidently don't hear it.—GILBERT H. VICKERS (G6GV) (Prestwich).

Club Membership Sought

SIR,—I have a great interest in amateur receiving and transmitting, and should be pleased to join a wireless club in the vicinity. My intention is thus to increase my practical and theoretical knowledge, and, if possible, to study the workings of a transmitter.—S. H. PERRY (14, Bovill Road, Honor Oak Park, S.E.23).

[Will the secretary of the local wireless club please note?—Ed.]

An H.T. Delay Action Relay: A Correction

SIR,—In reference to my wrinkle entitled "An H.T. Delay Action Relay," which was published in the November 30th issue, I should like to point out a small error which was due to a slip in my article.

The receiver ear-piece was referred to as being 60-watt; this, of course, should read 60 ohms.—V. D. BROOKER (Chelmsford.)

A Generous Offer from a Reader

SIR,—I shall always be pleased to give anyone a hand with the construction of any set published in PRACTICAL AND AMATEUR WIRELESS, and also help them out of any troubles which they may encounter afterwards. I am free Wednesday and Saturday evenings.—F. CREASEY (15, Evershed Cottages, Mill Lane, Oxted, Surrey).

A Beginner's S.W. Log

SIR,—I have been reading your excellent wireless journal since the beginning of August last. It made me very interested in short waves, and I have been looking out for some small short-wave receiver to construct. In your issue of September 14th you described a small inexpensive one-valve set constructed of spare wireless components, and using a home-made H.F. choke and coil. This greatly interested me, so a month ago I built the set. My high tension is sixty volts and the low tension two volts. I append my log and hope it will interest other beginners. Recently I picked up the end of a transmission from Addis Ababa, on about 25 metres. The programme was an Ethiopian soldiers' band playing marches. They were making their first broadcast to the Columbia Network, and their programme was announced by an American

CUT THIS OUT EACH WEEK.

Do you know

—THAT spilt accumulator acid should be immediately neutralised by placing soda or similar alkali upon it.

—THAT the above hint will prevent damage to carpets and clothing.

—THAT L.F. coupling condensers in mains receivers should be of the mica dielectric type in order to avoid the risk of a positive potential on the grid.

—THAT care is necessary when choosing a "block" condenser for use in a voltage-doubler circuit employing a metal rectifier.

—THAT artificial resonances should be avoided when designing a receiver or amplifier for high-quality programmes.

—THAT the loud-speaker mounting arrangement should also be carefully considered when building one of the above pieces of apparatus.

—THAT one of the simplest tests for a defective receiver is to measure the total anode current consumption.

—THAT for the above measurement a milliametre should be included in the common H.T. lead.

The Editor will be pleased to consider articles of a practical nature suitable for publication in PRACTICAL AND AMATEUR WIRELESS. Such articles should be written on one side of the paper only, and should contain the name and address of the sender. Whilst the Editor does not hold himself responsible for manuscripts, every effort will be made to return them if a stamped and addressed envelope is enclosed. All correspondence intended for the Editor should be addressed: The Editor, PRACTICAL AND AMATEUR WIRELESS, Geo. Newnes, Ltd., 8-11, Southampton Street, Strand, W.C.2.

Owing to the rapid progress in the design of wireless apparatus and to our efforts to keep our readers in touch with the latest developments, we give no warranty that apparatus described in our columns is not the subject of letters patent.

speaker. This transmission was picked up at about 22.15 G.M.T. My log is as follows:—

Amateur Transmissions.

G2HT, G6GO, G6DH, G5KJ, G5CG, G5GL, G5CJ, G5YY, G5CW, G5LW, G2OC, G2PX, G5VX, G2AV, G6HJ, G15MZ, G6PL, G2NJ, G2CP, G5XG, G5CY, G2AX, G6SR, G5ML, G6A5, G2AT, G2CT, G5SP, G5GC, G6GL, G6A8, G2GL, G6LD, G5RW, G5TA, G6IA, G6UL, G5MN, G6FC, G2LU, G6FH, G2TA, G6WR, G5PP, G2ZT, G6NF, G5HL, G6DL, G5ZN, G6OS, G2HQ, G6TR, G5TT, G6UW, W1KJ, W4CRE, LA1G, F8NH, W1CMD, FHPU, HB9T, OK3VA, W3WJ, W35FH, VO1L, W2BSD, FN5WK, G6PY, G5TP, G6MY, G5OW.

Commercial Transmissions.

W2XAF, EAQ, 2RO, DJC, HVJ, GSB, W8XK, HBP, W1XAL.
—STANLEY H. DALE (West Hartlepool).

Back Numbers Wanted

SIR,—I am in receipt of your letter and technical advice, enclosing Blueprint AW449, which is useless to me without the equivalent number of PRACTICAL AND AMATEUR WIRELESS. I shall be very pleased if any reader can let me have a copy of AMATEUR WIRELESS dated September 27th, 1934.—W. D. THOMSON (aged 14) (N.W.10).

[If any reader cares to send us a copy, we shall be glad to forward it.—Ed.]

Our Xmas Number

SIR,—Allow me to take the opportunity to congratulate you on the Christmas number and to wish P. W., yourself and staff the season's greetings. I think it a very wise step to feature the original Push-pull Amplification. By the way, why not extend the S.W. club ideas to PRACTICAL AND AMATEUR WIRELESS?—A. W. MANN (Middlesbrough).

A Supreme Superhet

SIR,—With reference to the letter from Mr. J. E. Higgins, in the current issue of PRACTICAL AND AMATEUR WIRELESS, I also am interested in a really good superhet such as described by Mr. Higgins.—GEO. A. PICKLES (Guernsey).

Schenectady Schedule

SIR,—I noticed in the current issue of PRACTICAL AND AMATEUR WIRELESS that the schedules for Schenectady were incorrect, according to a card received a few days ago. They are as follows:—

W2XAF, operating on a frequency of 9,530 kilocycles or 31.48 metres, is on the air every night, except Sunday, from 21.00 until 05.00, G.M.T. On Sundays, W2XAF is on from 21.15 until 05.00, G.M.T.

W2XAD, operating on a frequency of 15,330 kilocycles or 19.56 metres, is on the air every evening, except Sundays, from 19.00 until 20.00, G.M.T. On Sundays, W2XAD is on from 15.30 until 21.00, G.M.T.

I have found out that W2XAF comes on at 18.00, G.M.T., on Saturdays, to relay the college football games.

In a letter received recently from Schenectady, I was informed that they do not require Reply Coupons, as they are only too pleased to send cards to their listeners who send in regular reports. I am thirteen years old.—S. JONES (West Croydon).

LATHE WORK FOR AMATEURS

By F. J. CAMM.

1/- or 1/2 by post from

GEORGE NEWNES, LTD., 8/11, Southampton St., Strand, W.C.2.

A Fine Set of Records

ANOTHER most attractive set of records is a new recording of Stokowski and the Philadelphia Orchestra of Tchaikovsky's "Nutcracker Suite," a collection of lovely melodies, each in a different dance rhythm. It is played superbly by this great orchestra of over 100 players, and its finale—the "Waltz of the Flowers"—is one of the greatest and best waltzes ever written.

A waltz of another type is Johann Strauss's "Acceleration Waltz"—*H.M.V. DB2624*—Viennese, of course—a fine tune working up to a series of climaxes. It is played by Ormandy conducting the Minneapolis Symphony Orchestra.

New Vocal Records

A NEW-OLD record of Caruso takes a pride of place this month. The earlier re-creations (that is, an electrical re-recording of an older record, plus a brand new accompaniment) were experimental. Now the technique has been perfected, and Caruso himself might have stood before the microphone to sing "Recondita armonia" (strong harmony of sounds) from Tosca, and the lovely "Agnus Dei" of Bizet. The number of this interesting record is *H.M.V. DB2644*. Gigli, the finest of living operatic tenors, sings the "Flower Song" from Carmen on *H.M.V. DB2531*, coupled with "O del mio dolce ardor." Richard Crooks brings us on very familiar ground with "The Lost Chord" and "Thora" on *H.M.V. DB2571*.

A John McCormack Record

JOHAN MCCORMACK has made a record of "Believe me if all those endearing young charms," that is as fine as anything he has done. A new setting for the "Londonderry Air" ("Mary Dear") completes the record, which is an *H.M.V. DA1432*.

Two Verdi airs are sung by Margherita Perras, a full-toned soprano. They are "Requiem" from the "Requiem" with choir and orchestra, and "Ave Maria." The first is sung in Italian, the other in Latin. It is interesting to note that although this record—*H.M.V. C2794*—appears in the list as a Connoisseur issue, so much favourable comment has been received that it has been transferred to the General Catalogue.

Barrack-room Ballads

KIPLING'S poems ask for music, but few succeed in getting the correct atmosphere. Cobb's settings were successful, and Peter Dawson (with two to his own credit) is the ideal interpreter. The selection gives six of the Ballads—"Fussy Wuzzy," "Screw Guns," "Route Marching," "The Young British Soldier," "Cells" and "Mandalay." A fine recording with Male Chorus and Orchestra. The number of this disc is *H.M.V. C2797*.

Columbia Records

SYDNEY HOWARD—the comedian who is always in trouble—now starring in "Anything Goes," at the Palace Theatre, London, has made a new record for Columbia this month which is of unusual interest. It is a humorous sketch with the somewhat alarming title of "Sex, Sobs and Slaughter," which is full of typical Sydney Howard fun. That's the point, for Sydney Howard wants new jokes and "gags" for his future records and films and, in connection with the Columbia Company, is offering £20 in cash prizes for those which he and Leslie Henson think are the best. If you don't know Sydney Howard you should meet him in this record—*Columbia DX719*—and try for some of his cash prizes.

IMPRESSIONS ON THE WAX

By T. ONEARM.

"Parade of Parades"

QUENTIN MACLEAN is never stumped for ideas. His latest is "Parade of Parades," played on the Trocadero organ, in which he takes some half-dozen well-known "Parade" songs (e.g., "Parade of the Tin Soldiers," "My Love Parade," etc.) and links them up in the most ingenious manner. The number of this record is *Columbia FB1194*.

Hill Billy Songs

TURNER LAYTON, the popular tenor, has made three very fine records this month. The first is a "Hill

Billy Songs" medley on *Columbia FB1204*, in which he introduces "Ole Faithful," "Roll Along, Covered Wagon," "Wagon Wheels," "Last Round Up," etc.

The other two records are "The Echo of a Song" and "Dinner for One, Please, James," on *Columbia FB1205*, and "When Your Little Boy Grows Up" and "Stars over Devon," on *Columbia FB1206*.

Other Favourites

CLAPHAM AND DWYER contribute one of their old favourites in this month's lists in "Fairy Tales," on *Columbia FB1176*, while selections of Christmas melodies are given, in one case, by Sidney Torch as an organ solo, in "A Very Merry Christmas," on *Columbia FB1180*, and in "Say it with Carols" as a pianoforte solo by Billy Mayerl, on *Columbia FB1182*.



your radio in 1936

To the True Radio 'Fan,' the broadcast performance itself is often of secondary importance to the manner in which it is reproduced. Thus, a radio talk which appears insufferably tedious to every other member of the family may hold the enthusiast enthralled by the manner in which sibilants come through, the excellent 'colour' of the voice, and other subtleties which collectively make up what is generally known as 'realism.'

If you are a person who understands and enjoys the finer points of radio in this way, then you probably already use a 'W.B. 1936 Stentorian.' If not, you should certainly obtain one for the New Year, for there is no doubt that its amazing realism will lend a new interest to your radio listening.

Test a 'W.B. 1936 Stentorian' to-day. Listen to the 'bite' of the bow on the violin strings. Hear the real 'colour' in the bass notes in place of the toneless thump to which you have perhaps become accustomed. Notice how this amazing new Speaker brings speech or music 'forward' into the room—free from colouration or confusing resonances.

The delight of listening to high-class reproduction may be yours—now, and at surprisingly moderate cost. Ask your Dealer to demonstrate.

PRICES :	CHASSIS	MODELS.
1936 STENTORIAN	Senior	42/-
	Junior	32/6
CABINET MODELS.	Baby	23/6
36S (Senior)	Midjet	17/6
36J (Junior)	Duplex	82/-
36B (Baby)	EM/WJ	70/-



1936 STENTORIAN
 WHITELEY ELECTRICAL RADIO CO., LTD., (TECHNICAL DEPT.), MANSFIELD, NOTTS.

Practical and Amateur Wireless SERVICE DATA SHEET No. 14 FOR THE A.C. HALL-MARK

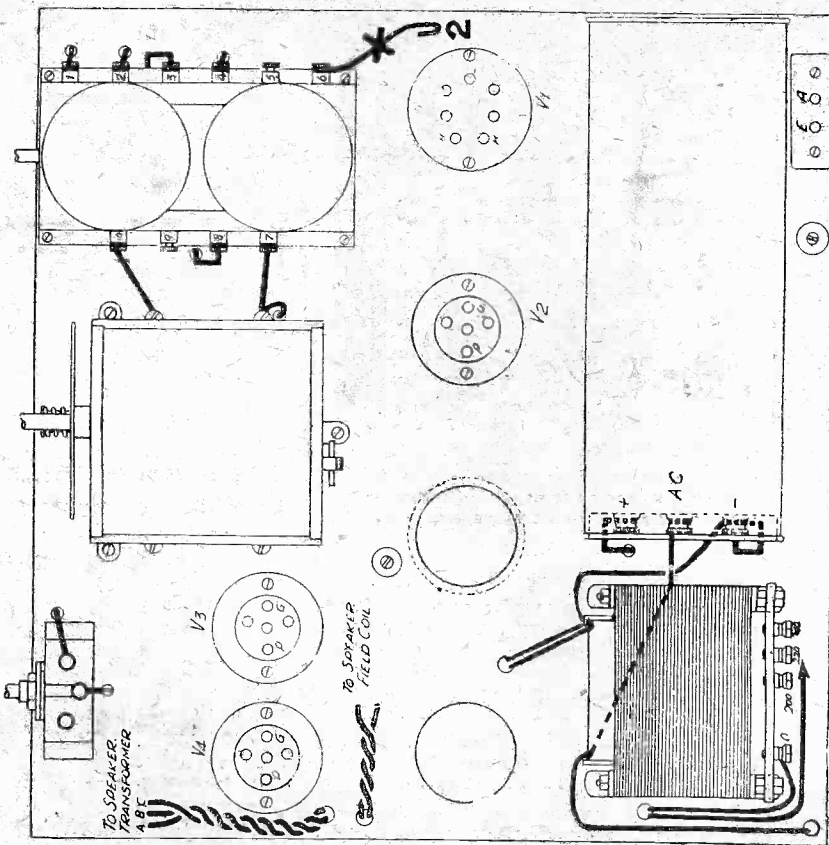

Top of Chassis View

Approximate Voltage Readings

Voltmeter—to E	
" + to 1	= 70 volts.
" + to 2	= 190 volts.
" + to 3	= 75 volts.
" + to 4	= 190 volts.
" + to 5	= 320 volts.

Approximate Current Readings

Milliammeter connected at	× 1 = 5 m.A.
" "	× 2 = 3 m.A.
" "	× 3 = 23 m.A.
" "	× 4 = 23 m.A.
" "	× 5 = 57 m.A.

Approximate Resistance Readings

Coils with Switch on Long Waves.
Ohmmeter connected across 4 and 6 = 10 ohms.

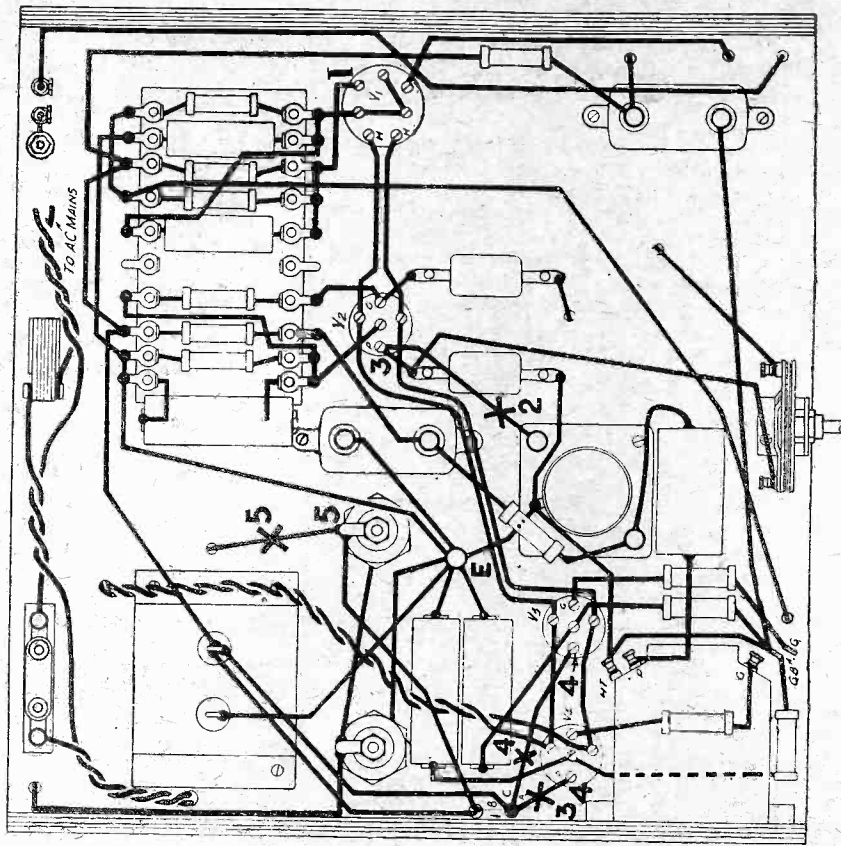

Underside of Chassis

Ohmmeter connected across	1 and 9 = 10 ohms.
" "	2 and 3 = 23 ohms.
" "	7 and 9 = 23 ohms.
" "	8 and 9 = 3 ohms.
Coils with Switch on Medium Waves.	
Ohmmeter connected across	4 and 6 = 1.7 ohms.
" "	1 and 9 = 1.7 ohms.
" "	2 and 3 = 4.5 ohms.
" "	7 and 9 = 4.5 ohms.
" "	8 and 9 = 3 ohms.

Practical Television

TELEVISION TOPICS

Television Spreads Its Wings

MANY proposals have been made in the past concerning schemes whereby the principles of television could be harnessed for the assistance of aviation, especially for the purpose of navigation in fog or inclement weather. With low definition standards most of the ideas propounded progressed but little beyond the embryonic stage, but now that clearly defined pictures can be radiated as non-fading signals on the ultra-short waves the whole situation has undergone a material change. Tests have already shown that good reception is possible in an aeroplane in flight, and research is now being undertaken with the idea of providing the pilot with a guiding eye. Guiding radio beacons now alleviate some of the fog difficulties encountered in locating and landing on aerodromes, but this is not sufficient. One suggestion, made incidentally some years ago, is to have a small radio transmitter in an aeroplane, and the signals from this will enable ground stations to ascertain its exact position. This will be

nature or size of the television equipment which will eventually be installed. The apparatus may have to go in the projection box with the standard film projectors, or on the other hand the design may call for back projection, with the equipment housed on the stage behind the screen. No doubt the cinema demonstrations which are promised shortly in London will help in this matter very considerably.

A Free Television Theatre

IT has already been suggested that a television theatre capable of giving free seating accommodation to a thousand people may be established in the West End of London as soon as the first high-definition television signals are radiated by the B.B.C. station. This will be used solely for the purpose of enabling the public to see and hear what they are capable of receiving in their own homes. Certain interests are already saying that this is an encroachment on their legitimate entertainment market, and are endeavouring to find ways and means for imposing embargoes. They cite as a

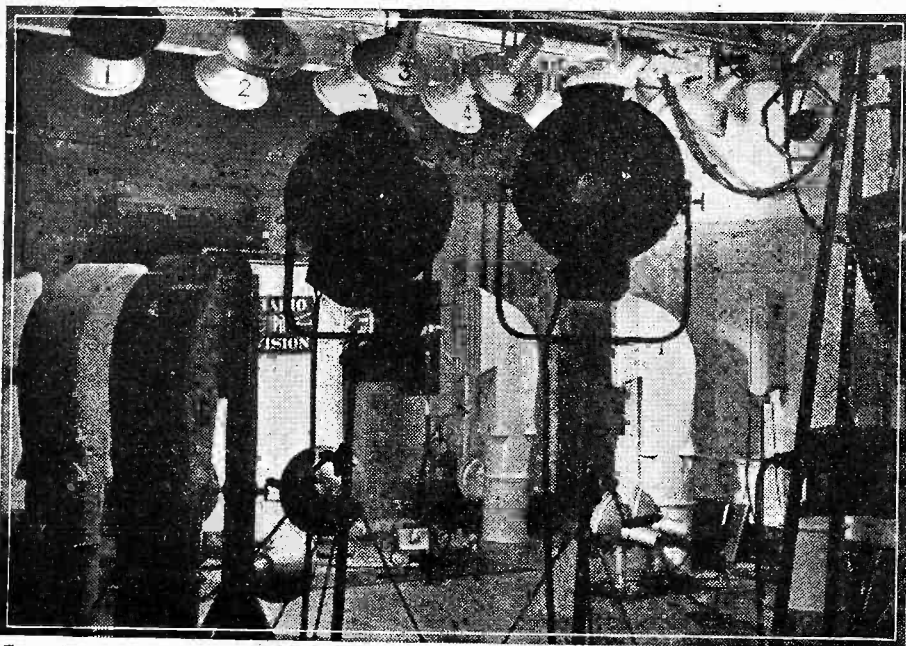

General view of the new television studio in the Ministry of Posts' building at Paris. Groups of up to six persons are scanned entirely by mechanical means. One-hundred-and-eighty line definition 25 frames-per-second is employed. Note the special ducts for supplying cool fresh air to prevent artists from feeling uncomfortable under the powerful lamps. These lights consume 40 kW.

plotted as a moving spot on a chart in a central control point, the chart will be televised, and the signals received on a set in the aeroplane's cockpit to show the pilot on a small screen exactly where he is, and what course he should follow in order to make a correct landing.

Coventry Looks Ahead

COVENTRY must now be added to the list of other towns which in planning their new cinemas are making what provision they can to accommodate television apparatus. This is a very commendable action, although the architects are, of course, handicapped by not knowing exactly the

precedent the line of action taken by newspapers over the dissemination of news and publication of programmes in the early days of radio. The whole matter should be capable of settlement by a conference of all the parties involved. As far as films are concerned, it appears that no entertainment film can be televised until after a certain period allowed for exhibition to the cinemas, but this does not apply to news-reels. At the present stage of television's development, however, it seems hardly possible that full length films are required, but rather excerpts, so after all this so-called "menace" may only prove to be a "storm in a tea cup."

How Many Points?

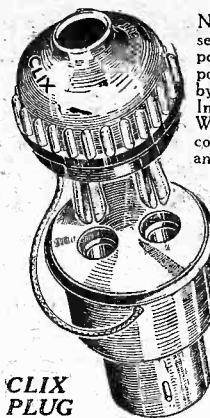

Now that winter is here and Radio sets get moved from one room or position to another, the lack of power points is quickly overcome by using a "Clix" Plug Adaptor. In addition to giving you an extra Wall Plug you have a perfect contact fitting for plugging into any lamp socket.

The performance of many excellent sets is often ruined at the source of electric supply by badly fitting plugs. The pins of the Clix Plug portion give perfect contact with all types of supply sockets. These Plug Adaptors are also very handy for use with domestic electrical apparatus.

9d. COMPLETE

From most Dealers, or Post Free for 1/- Postal Order.

**CLIX
PLUG
ADAPTOR**

**Replacements that make
for better results**

For the expenditure of a few pence you can replace those corroded Spade Terminals, or Wander Plugs with collapsed pins, and faulty Aerial-Earth connections.

FIT "CLIX" AND PREVENT "CLICKS"

Spade Terminals and Accumulators 1½d. and 2d. each. Wander Plugs for H.T. and G.B. Batteries 1½d. each. Heavy Duty Aerial-Earth Spades or Plugs 3d. each.

Faulty contacts ruin reception. Make sure of Perfect Contact by replacing with "Clix."

LECTRO LINX LTD.

79a, Rochester Row, London, S.W.1



**Instructions FREE . . .
By POST or FROM YOUR DEALER**

THINK of it! No need to buy an expensive radio-gramophone. This new "Cosmocord" Electric Pick-up will convert your present radio set and gramophone into a luxury performance radiogram for only 5/-. Easy to fit. Takes the place of gram sound-box. Fitted in 5 minutes. Splendid tone and volume. For both Battery and electric sets. Sent post paid for cash with order, otherwise C.O.D. Fees chargeable.

The
COSMOGRAM

**New Electric PICK-UP
COSMOCORD LTD., Enfield, Middlesex**

IT PAYS TO BUY THE BEST

AIR TUNED I.F. TRANSFORMER

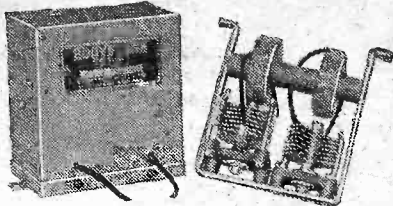

Compact unit with high efficiency air trimmers and genuine litz wound coils. Total tuning coverage 400 to 500 Kc/s. Gives high stage gain with approximately 9 Kc/s bandwidth. No. 1014. 450 kc/s. Price 13/6.

SCREENED H.F. CHOKE

Prevents choke coupling with other components, a frequent cause of instability in S.W. receivers. Honeycomb wound sections, Frequentite former, copper container.

No. 982. All Wave. 13-2,000 metres. Price 5/-.
No. 983. Short Wave. 10-200 metres. Price 3/6.

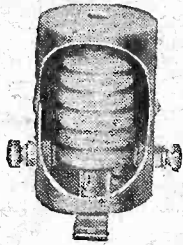

STRATTON & CO., LTD., BIRMINGHAM
Bromsgrove Street
London Service Depot:
Webb's Radio Stores, 14, Soho Street, Oxford Street, W.1

EDDYSTONE

SHORT WAVE COMPONENTS

ENGINEERS! ARE YOU EARNING LESS THAN £10 PER WEEK?

If so, you cannot afford to carry on without reading our 268-page Handbook. The book explains clearly and definitely many ways of carving out a successful career. Among other things it explains the Services of our unique Appointments Department, outlines Home-study Courses in all branches of Civil, Mechanical, Electrical, Motor, Aero, Wireless, "Talkie," Eng., Building, etc., and gives details of B.Sc., A.M.I.C.E., A.M.I.E.E., A.M.I.Mech.E., A.M.I.A.E., A.M.I.W.T., A.M.I.R.E., G.P.O., MATRIC, and all Exams.—We alone Guarantee "NO PASS—NO FEE." Whether you be an old hand or a budding apprentice, get this book to-day—FREE and POST FREE.



BRITISH INSTITUTE OF ENGINEERING TECHNOLOGY.
Recently removed to greatly enlarged premises at
409, Shakespeare House, 17/19, Stratford Place, London, W.1.

EASY TERMS

We specialise in the supply of all good quality Radio sets, components, and accessories. Send list of requirements and keen quotation will be sent promptly.

CASH & G.O.D. ORDERS DESPATCHED BY RETURN POST. PRICE LIST FREE.

The LONDON RADIO SUPPLY Co.
11, OAT LANE, NOBLE ST., LONDON, E.C.
Phone: NATIONAL 1977.

362 VALVES

THE VALVE WITH THE SIX MONTHS GUARANTEE!

STONEHAM ROAD, LONDON, E.5. Phone: GLISSOLD 6607

REPLIES IN BRIEF

The following replies to queries are given in abbreviated form either because of non-compliance with our rules, or because the point raised is not of general interest.

D. M. (Ormean Road). We could not post your reply as you omitted to include the name of your town. We recommend the Add-on H.F. Unit described in *AMATEUR WIRELESS* dated December 1st, 1934. A full-size blueprint, showing the layout of all components may be obtained from this office, price 1s.

J. W. (Bingley). We regret that the lists of the Club you refer to are now full, and it is not proposed to take any more members.

C. A. (Londonderry). The circuit arrangement is incorporated in practically all types of coil, but it would appear that the Lucerne Coils are indicated. Any good modern coil could, however, be employed in the circuits shown.

W. G. (Canning Town). Do you wish to rebuild your receiver? We could not, of course, supply a blueprint for a commercial receiver, but you could dismantle the set and build one of our receivers, including some of the parts from the dismantled set.

J. W. G. (Welling). Can you state in what manner the set is unsuitable for use with a pick-up? We cannot understand this remark as it should be in order to arrange for the use of this component.

M. P. (Darlington). We think you could use the coil, but as it was designed by a contemporary we regret that we are unfamiliar with the circuit details and terminal numberings.

F. W. L. (Hulme). We have no blueprint of a set of the type outlined by you.

N. H. (Ashton-u-Lyne). A current may be passed through a winding arranged round the magnet, but there are a number of firms who specialise in this remagnetising process. The condenser may be stripped in the manner indicated.

R. W. (Lutterworth). It should be possible to use the coils, but we cannot guarantee results as the inductance is not matched to the oscillator coil and thus separate tuning condensers would be required.

F. A. (Hull). The ratio should be not greater than 4 to 1.

H. V. E. (Medan, Sumatra). The windings should consist of 6 turns per volt. For the primary, therefore, you need 750 turns and for the secondary 12 turns. Are the valves of the indirectly-heated type? If not, serious hum difficulties may be experienced or the output will have to be rectified.

J. B. (Midlothian). The fault is not clear. Do you mean that the cap has come adrift from the valve, or simply that the valve has become defective? The absence of grid bias would no doubt result in loss of emission in time.

J. K. (Hull). We have no details for you. The reference to the technical press simply meant that we do give, from time to time, articles on the subject of mains conversion, and it is necessary to follow the hints given, adapting them to individual requirements.

A. I. (Clarkston). A mains transformer and rectifier should be the only extra components needed. These should be arranged as shown on page 334 of our issue dated November 30th, 1935 (Fig. 2).

A. H. (Ashburton). We cannot help you with the frame aerial details. If you wish to add an H.F. stage you could not employ the H.F. coil, but this would have to take the place of the present frame, which would then have to be included in the grid circuit of the added H.F. stage.

A. M. (Bockburnslath). The disconnection of the speaker will not affect the valve in the circumstances mentioned by you.

R. R. L. (E. Molesey). We have not published details of the apparatus you mention.

J. L. (Walton). The set should be quite suitable for use with your eliminator, and your speaker is ideal.

S. S. (Whitwell). Your lengthened aerial will increase the volume of the local, but might introduce difficulties in selectivity.

J. O'H. (Birmingham). We cannot suggest what is wrong without some further details.

R. B. J. van H. (Ventersburg). We would not recommend the set in question for your particular requirements. A good short-wave superhet would be preferable.

J. D. (Maryport). We have no blueprint of an adaptor employing the coil in question.

A. E. G. (Ellesmere Port). The transformer may have a ratio of 3 to 1, or 4 to 1. The coils are anchored at one end to earth (the metallised chassis).

A. I. T. (Southport). We regret that we cannot advise you concerning the Russian station.

F. W. M. (Ide). The receiver should be quite suitable for your needs, and the parts may be obtained from Peto-Scott, whose advertisements appear in our pages.

O. M. W. (Acocks Green). The apparatus is not yet on the market, and is only in an experimental stage.

W. E. (Alnwick). The only blueprint which we have giving a circuit of an A.C. receiver employing a T.D. coil is the A.C. Selectone. This does not, however, employ an H.F. stage, and only one of the coils is employed.

H. M. (Cawthorne). The output from the receiver is obviously insufficient. The speaker which he is at present using is more sensitive to a weak input, but will not handle the same output as the new M.C. speaker.

RADIO CLUBS AND SOCIETIES

Club Reports should not exceed 200 words in length and should be received First Post each Monday morning for publication in the following week's issue.

SLADE RADIO

ON Thursday, December 5th, the Slade Radio held their Fifth Annual Dinner. The event was a great success, fifty-eight members and friends being present. Hon. Sec., Chas. Game, 40, West Drive, Heathfield Park, Handsworth, Birmingham.

SPHERE SHORT-WAVE CLUB

THE Sphere Short-Wave Club has been in existence for about two months. It now holds its meetings at the Headquarters of the British Legion, Laisterdyke branch, 66, New Lane, Laisterdyke, Bradford, on Friday evenings, commencing at 7 p.m., but the club is open every night. We had an enjoyable evening recently with a short-wave set on which was logged a few stations, whilst one or two members were interested in a Morse class.

To finish the evening 2BRT of Fagley gave an interesting talk on elementary principles, in which all members were extremely interested.

We shall be pleased to welcome any new members who wish to come. G. Walker (Hon. Sec.), Napier Road, Thorbury, Bradford.

LEICESTER AMATEUR RADIO SOCIETY

THE above Society is being reorganised, and held a general meeting on December 17th, at which future activities were discussed. Hon. Sec., W. Winder, Lutterworth Road, Leicester.

NELSON AND DISTRICT SHORT-WAVE SOCIETY

AN inaugural meeting of "The Nelson and District Short-Wave Society" was held on December 10th, an attendance of twenty-eight making the signs good for the prosperity of the Society.

At the moment, three members are active transmitters, Mr. R. M. Hardy, G2RB; Mr. P. Nicoll, G5ZN; and G. Haworth G5XC; whilst five others are BRS members of RSGB, making a total of eight who belong to that body.

As most of the time at the meeting was spent in explaining the aims and objects of the Society, election of officials, etc., it was not possible to formulate a detailed curriculum. We did discuss the question of Morse, and it was unanimously agreed to have one hour's practice weekly, commencing at once.

Any reader in this locality will be welcome, and the knowledge of the more-experienced members will be freely given to anyone seeking advice on SW matters. Send a post-card to the address given below for particulars of time and place of meeting. There is no entrance fee, and the subscription has been provisionally fixed at threepence per week.—G. Haworth, Sec., Merova, Wheatley Lane Road, Barrowford, Lancs.

THE RADIO PHYSICAL AND TELEVISION SOCIETY

ON Friday, December 13th, by way of an interesting innovation, members of this Society took part in an informal debate. The subject, an ever provoking one among radio amateurs, was "Should the would-be amateur transmitter be compelled to pass the Morse test." Mr. J. Gilbert Hobbs (G2QG), speaking against the Morse test said that where the Morse code takes some months to learn, and then without it furthering the objects of radio, the time spent could be used far more beneficially by the would-be amateur in the theoretical side of radio. He challenged anyone to quote an instance when an amateur station had been warned by a commercial station in code that he was causing interference. "That," he said, "was the real reason why the Post Office required the amateur transmitter to have a knowledge of Morse."

Mr. Licence speaking for the Morse code quoted instances where Morse had been of great use in emergencies, especially in America where amateurs had been able to preserve communications in the case of floods and hurricanes, and he also said that it was of great personal benefit to the amateur to know Morse, especially in the case of D.X. work. Numerous other views were put forward by those present.

Meetings are held every Friday at 72A, North End Rd., West Kensington, at 8 p.m. Those requiring further details of meetings and lectures should write to the Hon. Sec., Mr. E. Arnold, 12, Nassau Rd., Barnes, S.W.13.

SOUTH LONDON AND DISTRICT RADIO TRANSMITTERS SOCIETY

ON Wednesday, January 1st, 1936, a lecture will be delivered to the members of this society by Mr. A. T. Mathew, B.Sc. (G5AM), entitled "Factors Affecting Radio Propagation." Our meetings are always held on the first Wednesday of every month, commencing at 8 p.m., at The Brotherhood Hall, Knights Hill, West Norwood, S.E.27. We are always pleased to welcome visitors and prospective members at these meetings, and anyone interested in short-wave radio, either transmission or reception, can be assured of a hearty welcome.—E. T. Woodhouse-Rayner, Publicity Manager, 20, Somerton Road, Peckham Rye, London, S.E.15.

If a postal reply is desired, a stamped addressed envelope must be enclosed. Every query and drawing which is sent must bear the name and address of the sender. Send your queries to the Editor, PRACTICAL AND AMATEUR WIRELESS, Geo. Newnes, Ltd., 8-11, Southampton Street, Strand, London, W.C.2.

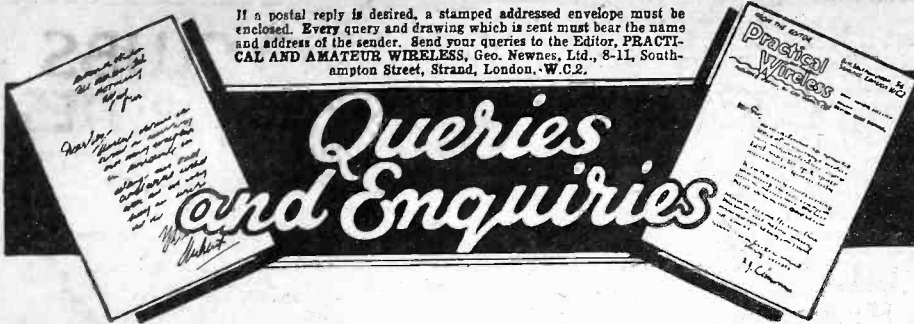

Queries and Enquiries

SPECIAL NOTE

We wish to draw the reader's attention to the fact that the Queries Service is intended only for the solution of problems or difficulties arising from the construction of receivers described in our pages, from articles appearing in our pages, or on general wireless matters. We regret that we cannot, for obvious reasons—

- (1) Supply circuit diagrams of complete multi-valve receivers.
- (2) Suggest alterations or modifications of receivers described in our contemporaries.
- (3) Suggest alterations or modifications to commercial receivers.
- (4) Answer queries over the telephone.
- (5) Grant interviews to querists.

Please note also, that queries must be limited to two per reader, and all sketches and drawings which are sent to us should bear the name and address of the sender.

Pick-up Hum

"I have built the A.C. Hall-Mark Four and must express my extreme satisfaction at the high performance of this receiver. On radio it is impossible to wish for better results, but I have not been so successful with the gramophone pick-up. My trouble is hum, and no matter what I have tried I cannot cure this. When receiving radio (I have fitted a change-over switch) there is no hum of any kind. When, however, I switch to gramophone the hum is too loud for comfort. I have screened the leads and changed the position of the switch, but to no effect. Can you suggest a possible cure?"—L. S. D. (Wadebridge).

THE trouble seems to be due to L.F. pick-up, either from the L.F. components (transformer, choke, etc.), or from the actual motor which is employed. In such an extreme case you will no doubt find that the ordinary type of screening is inadequate, and we therefore suggest that you employ for the leads to the pick-up or switch, a length of ordinary lead-covered electric-light cable. The lead covering should be soundly earthed. It would also be preferable to ascertain whether your motor is causing hum by induction between it and the actual pick-up, and for this purpose an earthed iron plate should be placed between motor and pick-up as an experiment. Subsequently, a screening plate may be found desirable between the two parts, and the method of arranging this will depend upon the motor, cabinet, etc.

Fuse Difficulty

"I have built a four-valve battery set but cannot keep a fuse more than a week. It always goes when I switch off. I have replaced it and tried larger values, but it is always the same. After a few nights, I switch off and there is a slight flash from the set and another fuse is required. Can you help me to find the reason for this?"—G. U. (Edgware).

IN a normal receiver such a happening should not occur. The trouble may be due to a faulty component or wiring, or to inclusion of the fuse in the wrong position.

If a condenser is arranged with a leak to earth, and the fuse is included in this circuit, it is possible that the sudden surge which arises when the L.T. supply is interrupted may blow the fuse. If the fuse is too low in value it may also blow in this manner. But we think that you have probably included it in the wrong position. It should be placed in the H.T. negative lead, with the L.T. negative lead and earth connections on one side of the fuse and the H.T. negative lead on the other. A circuit of your receiver would enable us to go into the matter more fully.

Using an Old H.T. Battery

"I have a 120-volt H.T. battery which has dropped to 90 volts, and I was thinking instead of throwing it away I might use it to light a 4-volt flash lamp for lighting a small cupboard for a few minutes at a time. I thought of using a potentiometer in series with it, but am at a loss to know the ohms required. Could you give me the necessary information?"—J. C. (Dairsie).

THE discharged battery could not be normally used in the manner you suggest. It would be better to dismantle the battery and select the cells which are not corroded, broken or which are able to give some current when a lamp is placed across them. Then you could connect these good cells in sets of three in series with each other, and each set of three in parallel. This will give a 4.5 volt output of high current rating and enable you to carry out your scheme.

Current and Volts

"I recently had to examine a set which gave poor results. After some tests I found that the voltage on the anode of the detector valve was low. Subsequently I found that when the anode was joined to earth it was still lower. By degrees I found that by removing the decoupling condenser (2 mfd.) I could get a normal reading on the detector valve. I replaced this with another condenser and everything was in order. I cannot understand why my short-circuit introduced a lower voltage as it was in the detector circuit, nor can I see how the faulty condenser can have caused a lower voltage reading."—H. G. F. (Wadebridge).

THE condenser was obviously short-circuited, or partially short-circuited. Thus, there was an increased load on the mains-section and this would naturally result in a reduced voltage output. You appreciate, of course, that the output of a mains section may be varied by increasing the current, at which the voltage will be lowered, or by reducing the current, in which case the voltage will increase. Your additional short-circuit obviously, therefore, reduced the H.T. voltage.

A.C. Converter

"I have a home-built A.C. receiver employing two H.F. stages, and should like to try my hand at short-wave reception. I therefore want either an adapter or con-

verter which may be used either with the present H.T. supply or with its own supply. Can you recommend the most suitable type of unit and let me have a diagram?"—J. N. H. (Clacton).

WE would suggest that you build a converter-adapter so that you may employ either the superhet circuit or the ordinary adaptor arrangement. As your receiver is an A.C. model we would recommend that you obtain Blueprint P.W.48A, which describes a unit suitable for A.C. use and which may easily be used in either manner. You will then be able to adjust it and employ the arrangement which you find most suitable with your particular set of conditions.

Charging and D.C. Mains

"Can you tell me the most effective way of using our electric-light mains for the purpose of charging my accumulators. Our supply is 230 volts D.C."—A. L. E. P. (E.12).

THERE are two alternatives available to you. You can either connect a resistance in series with the mains in order to limit the current to the accumulator, or connect the battery in series with some of the ordinary house lights for the same purpose. The latter method is preferable during the winter months when lights are on for long periods, and by careful choice of the lamps used it is possible to obtain a fair charging rate. Otherwise, if it is desired to avoid a large drop in the brilliancy of the lamps, long charging periods are necessary, and thus the battery comes within the range of trickle charging.

Variable Selectivity

"I wish to incorporate variable selectivity with an old I.F. transformer which I have got. This is one of the ordinary unscreened components with the screen removed, I believe, for experimental purposes. The primary and secondary are both provided with taps presumably at the centre, but the two coils are cemented on the former so that I cannot easily move the positions. Can I use a condenser between them or any other scheme to get variable control?"—T. O. (Swansea).

A SMALL condenser may be used joined across the high-potential ends of primary and secondary, but a very low capacity is required. One of the special trimming condensers would be most suitable for the purpose. Alternatively, you could wind a small coil in between the primary and secondary and join this in parallel with a resistance connected in series with the H.T. supply or earth for the purpose.

American Valve Type

"I have an American valve which appears to be type 12-5. In the space between the figures there is what I think is a capital letter, probably A, but this is not certain. The valve has a 7-pin base. Can you help me by giving details of the valve?"—G. T. (Bradford).

The valve is undoubtedly the 12A5, which is a power pentode. We cannot trace any other type of valve which might be mistaken for this, unless your figure 5 is actually the figure 3, when the valve might be one of the rectifiers. The power pentode 12A5 is of the A.C. type, with a 12.6-volt heater, and is designed for an external load of 3,800 ohms. The undistorted output of this valve is rated at 2.6 watts.

The coupon on cover iii must be attached to every query.

Miscellaneous Advertisements

Advertisements are accepted for these columns at the rate of 3d. per word. Words in black face and/or capitals are charged double this rate (minimum charge 3/- per paragraph). Display lines are charged at 6/- per line. All advertisements must be prepaid. All communications should be addressed to the Advertisement Manager, "Practical and Amateur Wireless," 8, Southampton Street, Strand, London.

RECEIVERS, COMPONENTS AND ACCESSORIES Surplus, Clearance or Secondhand, etc.

PREMIER SUPPLY STORES

OFFER the Following Manufacturers' Brand New Surplus Goods at a Fraction of the Original Cost. All goods guaranteed perfect. Carriage paid over 5/-; under 5/- postage 6d. extra; I.F.S. and abroad carriage extra; orders under 5/- cannot be sent c.o.d.

PLEASE Send 3d. Stamp for Large New Illustrated Catalogue, also December Bargain Supplement.

WORLD Famous Continental Valves, mains type 4/6 each H.L., L.; screen grid; variable mu screen grid; 1, 3 and 4 watt A.C. output directly heated pentodes; 250-volt 60 m.a. full wave rectifiers, V.M.H.P., D.D.T., diode tetrodes; A.C., D.C. types, 20 volts, 0.18 amp., filaments; screen grid; variable mu screen grid; H., H.L., power and pentodes.

THE Following Types, 5/6 each; 350v. 120 m.a., full wave rectifiers, 500v. 120 m.a., full wave rectifiers, 2 1/2 watt indirectly heated pentodes.

2-VOLT H.F., L.F., 2/3; power, low consumption mu screened grid, 5- or 4-pin pentodes, V.M.H.P., H.F.P., Class B, 5/-.

THE Following American Types, 4/6; 250, 210, 245, 47, 46, 24, 35, 51, 57, 58, 55, 37, 80, 6A7, 2A7, 27, 77, 78, 2A5, 2S1; all other American types, 6/6 each.

RELIABLE Soldering Irons, 200-250 volts, 2/6, consumes 0.2 amps.; super type, 3/9.

PREMIER Short-wave Tuning Condensers (S.L.F.), complete, ceramic insulation, silver sprayed, brass vanes, noiseless pigtail, 0.00015, 0.00016, 0.0001, 2/9; double spaced 0.00005, 0.000015, 0.000025, 3/- each.

BRASS Reaction Condensers (S.L.C.), with integral slow-motion, 2/9; mica condensers, 0.00002, 0.00005, 6d.

PREMIER Short-wave Coils, with circuit, 4- and 6-pin type, set of 4, 13-170 metres, 7/-; for either type; Lowloss formers, 4- and 6-pin ribbed, 1 1/2 in. diameter, 1/-; short-wave valveholders, 4-, 5- and 7-pin chassis type, 6d.

B.T.H. Moving Coil Speakers, matched pairs, 8in., 1,500 ohms, 7,500 ohms (1,500 speaker as choke, 7,500 speaker in parallel with H.T. supply), with output transformer for pentode, 15/6 per pair; A.C. kit for pair, 12/6.

MAGNAVOX Moving Coil Speakers, 6 volt fields, handles 5 watts, 12/6. State transformer required.

M.C. Multi-ratio Output Transformers, 2/6; 2-1 or 1-1 output transformers, 2/6; microphone transformers, 50 and 100-1, 2/6; 3 heny chokes, 2/6; 100 heny chokes, 2/6.

LARGE Selection of Pedestal, table and radiogram cabinets at a fraction of original cost.

BLUE SPOT 29 P.M. Moving Coil, multi-ratio transformer, 15/-; handles 4 watts; Sonochorde ditto, ideal for battery sets, 10/6.

ELIMINATOR Kits.—120v. 20 m.a., 20/-, trickle charger, 8/-; 150v. 30 m.a., with 4v. 2-4 amp. C.T., L.T., 25/-, trickle charger 6/6 extra; 250v. 60 m.a., with 4v. 3-5 amps. C.T., L.T., 30/-; 300v. 60 m.a. with 4v. 3-5 amps., 37/6; 200v. 50 m.a., with 4v. 3-5 amps., L.T., 27/6.

PREMIER L.T. Charger Kits, input 200-250v. A.C., output 8v. 1/2 amp., 14/6; 8v. 1 amp., 17/6; 6v. 2 amp., 27/6; 30v. 1 amp., 37/6; 2v. 1/2 amp., 11/-.

B.T.H. Truessed Induction Type, A.C. only, gramophone motor, 100-250v., 30/-; ditto D.C., 42/6.

COLLARO Gramophone Unit, consisting of A.C. motor, 100-250v., high quality pick-up and volume control, 45/-; motor only, 30/-.

EDISON Bell Double Spring Gramophone Motors, including turntable and all fittings, 15/-.

WIRE-WOUND Resistances, 4 watts, any value up to 50,000 ohms, 1/-.

MAGNAVOX Speakers.—144 Magna, 25/-; 152 Magna, 37/6; 154, 12/6; 152, 17/6; all 2,500 ohms. Energising kits, 10/-; permanent magnet, 7in. cone, 16/6; permanent magnet, 9in. cone, 22/6; state transformer required; all other types in stock.

AMERICAN type, 250 valves, 9 watts, in push-pull; matched pairs, 9/-.

12-2,000 metres, without coil changing, Lisson All-band 2-gang screened coils, for screened grid H.F. stage (tuned), screened grid detector type receiver, circuit supplied, giving complete details, 12/6.

BRITISH-MADE Meters, moving iron flush mounting B 0-10, 0-15, 0-50, 0-100, 0-250 milliamps, 0-1, 0-5 amps., all at 6/-; read A.C. and D.C.

1,000 Ohm 150 milliamp., semi-variable resistance 2/-; 1,000 ohm, 250 milliamp., tapped for any number 0-18 valves, 3/6; 800 ohms 350 m.a., tapped, 2/-.

(Continued at top of column three)

PILOT AUTHOR KITS IMMEDIATE DELIVERY CASH, C.O.D. or H.P. CENTAUR 3

SEND FOR PRICED LIST OF PARTS KIT "A" CASH OR C.O.D. CARRIAGE PAID £2/13/6

Author's Kit of first specified parts, less valves and cabinet. Balance in 11 monthly payments of 5/-

KIT "B" As for Kit "A" but including set of first specified valves, less cabinet. Cash or C.O.D. Carriage Paid. £3/13/3, or 12 monthly payments of 6/9.

£4 SUPERHET BATTERY VERSION

KIT "A" CASH OR C.O.D. CARRIAGE PAID £4/4/0

Author's Kit of first specified parts, including ready-drilled Metaplex Chassis, less valves, cabinet and speaker. Balance in 11 monthly payments of 7/9.

KIT "B" As for Kit "A", but including set of 4 first specified valves, less cabinet and speaker. Cash or C.O.D. Carriage Paid. £6/15/0. Balance in 11 months monthly payments of 12/6.

If Peto-Scott specified Horizontal Cabinet is required with Kit "C" instead of Vertical Model, add 19/- to Cash or C.O.D. price, or 1/8 to Deposit and to each monthly payment.

A.C. VERSION

KIT "A" Author's Kit of first specified parts, less valves and cabinet. Cash or C.O.D. Carriage Paid. £10/2/8, or 17/6 deposit and 11 monthly payments of 18/6.

1 Set of 4 specified valves £3/9/6. Peto-Scott Console-type Cabinet £2/0/0.

PETO-SCOTT Co. Ltd. 77, Pr. Wt., City Rd., LONDON, E.C.1. EST. 1919.

ELECTRADIX

LOUD SPEAKERS, Special 5/- bargain Table Speaker, new and complete. Just the extra speaker you want for tone balance, or for another room. New Siemens in carton, 5/- only.

HOME RECORDING. For Record Making on your own grammo. Acoustic de Luxe Model "MI-VOICE," complete in maker's carton. List, 45/-, Sale Price, 21/-.

X-RAY OUTFITS, Coils, Rotary Interruptors, 7-in. Bulbs and Fluorescent Screens cheap. X-Ray Tubes from 10/-, 6-v. Battery Coil to 200,000 v., 21/6.

NEON TUBE, decoration 2-colour, 5ft. x 4 ft. glass mounted. Seen Working, £4 10/-.

MAINS TRANSFORMERS. Large range, all outputs, 500 watts, 32/6; 400 watts, 30/-; 100 watts, 21/6.

COMMUTATORS: For Dynamos, Motors, Interruptors and Multi-switches. Engine built, 24 copper segments, mica insul. Finely finished. Worth 7/6.

SMALL MOTORS. A.C. 230-v. Induction enclosed, 1/25 h.p., 18/-; Sturdy 1/10 h.p. ditto, 35/-.

ROTARY CONVERTERS by E. D. Co. New A.C. to D.C. 90 watts, £7. 400 watts, £16. D.C. to D.C. 12 v. to 50 v., 200 m/a, 75/-; ditto to 350 m/a, in cabinet, 95/-.

CONDENSER BARGAINS, 1 mfd. condensers, 250 volts, 3 for 1/-; 2 mfd. 2 for 1/-. All tested O.K.

CRYSTAL SETS are here again and very popular for clear, quiet reception. Cheap and need no battery.

Write for Special Bargain List "N" Free.

ELECTRADIX RADIOS

218, UPPER THAMES STREET, LONDON, E.C.4

Telephone: Central 4011.

(Continued from foot of column one)

COSMOCORD Pick-ups, with arm and volume control, wonderful value, 10/6; super type, 12/6. THE following lines 6d. each or 5/- per dozen: 4-, 5- or 7-pin baseboard or 4-, 5- or 7-pin chassis mounting valve holders, American valve holders, 1-watt resistances, wire end, every value; tubular wire end condensers, 1,500 volt, every value up to 0.5, 3 amp., 2- or 3-point switches, Cydon double trimmers, 6 yds. Systoflex, 1, 1.5, 2 or 2.5 mm. 1 yd. 7-way cable, 9ft. resin coated solder, 6 yds. push-back connecting wire, 2in. knob.

ELECTROLYTIC Condensers.—T.C.C. 8 m.f. 550v. 4/-, 15 m.f. 50v. 1/-, 15 m.f. 100v. 1/-; 50 m.f. 12v. 1/-; Dubilier 4 or 8 m.f. 500v. 3/-; 8 plus 4 500v. 4/-, 50v. 50 m.f. 1/9, 12 m.f. 20v. 6d.; U.S.A. 4, 8 or 12 m.f. 550v. 1/9, 100 m.f. 12v. 1/3; 8 plus 4500v. 2/3, 4 plus 4 2/-, 8 plus 8 2/6. Paper condensers, Dubilier 4 m.f. 500v. working, 4/-; ditto, 700v., 5/-; ditto, 800v., 6/-; Western Electric, 250v. working, 1 m.f. 6d., 2 m.f. 1/-, 4 m.f. 2/-.

CONDENSER Blocks, 6 m.f. 2/-, 10 m.f. 3/-, 8.5 m.f. 2/6; 250v. working, various taps.

POTENTIOMETERS by Best Manufacturers: 200, 350, 500, 1,000, 2,500, 5,000, 8,000, 10,000, 15,000, 25,000, 50,000, 100,000, 250,000, 500,000, 1 meg., 2/-; 5,000, 10,000, 15,000 with mains switch, 2/-.

PREMIER Mains Transformers, all have tapped primaries, C.T., L.T.s and engraved terminal panel; combined H.T.8 and H.T.9, 2 L.T.s 10/-; rectifier, 8/6 extra; H.T.10. 2 L.T.s, 10/-; rectifier 9/6 extra; 250 plus 250, 60 m.a., 3 L.T.s, 10/-; 350 plus 350, 150 m.a., 3 L.T.s, 12/6.

HIGH GRADE Push-Pull Input Transformers, 4/6. High grade Intervalve Transformers, 3/6.

BAKELITE Reaction Condensers 0.0001, 0.00035, 0.0005, 9d.; Pre-set condensers, any value, 6d.

SHORT-WAVE Ribbed Formers, 4- or 6-pin valve holder fitting, 3 x 2 1/2, 1/-.

BRITISH Radiophone Screened Down Lead, 20 feet, 3/6; Cossor Class B input and output transformers, 2/6 each.

BRITISH Wirewound Potentiometers, 10,000 plus 50,000 ohms, with mains switch, 1/6.

CLARION Moving Light Slow Motion Dial, with 2in. knob, for short waves, 2/-; Simpicon, full vision drive, 2/-; Utility, disc drive, 1/6.

B.T.H. Moving Coil Speakers, 8in. pentode transformer, 1,500 ohm or 7,500 ohm, 8/6.

KOLSTER-BRANDS Moving Coil Speakers, 1,500, 2,000 or 2,500 ohms, 7in. diameter, 7/9.

PREMIER All Brass Short-Wave Condensers, 0.00015, integral slow motion, 3/9; British Radiophone, all brass 2-gang condensers, 0.00015, 5/-; Ormond 0.00025 O.K., for short waves, 1/6; Polar all-brass 0.0005 slow motion, 3/11; Lissen 2-gang 0.0005, front trimmer, disc drive, 5/11; Utility 3-gang, fully screened trimmers, disc drive, 7/6; American 3-gang with trimmers, 3/-.

LISSEN 3-gang Superhet Coils, 6/-; iron core coils, with circuit, 2/11 each; Varley band-pass aerial coils, B.P.5 type, 2/9; ditto band-pass transformers, B.P.8, 2/6; H.F. chokes, Premier, screened, 1/6; Premier short-wave, 9d.; manufacturers' type, 6d.

LISSEN 3-gang Bandpass Coils, complete with L switching, 6/11. Complete circuit supplied.

PREMIER Smoothing Chokes, 25 m.a. 20 henrys, 2/9, 40 m.a. 30 henrys 4/-, 60 m.a. 40 henrys 5/6, 150 m.a. 40 henrys 10/-; 60 m.a. 80 henrys, 2,500 speaker replacement, 5/6.

PREMIER Auto Transformer, 10/200-250 and vice versa, 100 watt, 10/-, 50 watt 7/-.

MANUFACTURERS' Type Mains Transformers, 350/850 120 m.a. 3 L.T.S., 10/6; 500/500 150 m.a. 4 L.T.S., 19/6.

PREMIER Super Public Address Amplifier, incorporating the new 6B5 valve (see "Wireless World," July 15), 10-watt model, all A.C., enormous gain, phase inversion, £7/7, with valves; 20-watt model, 10 guineas; suitable speakers in stock. Microphones, 3-guinea model with stand and transformers, single button type, 19/6; Western Electric type on base with transformer, 4/6.

TELSEN 5-1 Radiogram Transformers, 2/9; 1-1 coupling unit, 2/9; Class B driver, 2/9.

RELIABLE Morse Keys with Code Engraved on Base, 2/-; Reliable Headphones, 3/6 per pair.

SPECIAL Offer.—Set of 3 short-wave coils, 4-pin type, covering 14-150 metres, with circuit, 4/-.

PREMIER SUPPLY STORES

20-22, High St., Clapham, S.W.4 (Phone: Macaulay 2381), and 165, Fleet St., E.C.4 (next door to Anderson's Hotel). Phone: Central 2833.

ALL goods advertised in last week's issue, still available.

WARD, 46, Farringdon Street, London, E.C.4. Telephone: Holborn 9703.

"NORTHUMBRIA" All-wave AC Three, £5/15/6; Four, £7/17/6. Booklet from Novo Radio (2), Union Works, St. John Street, Newcastle-on-Tyne, 1.

HOME CONSTRUCTORS of Coils, Chokes, and Transformers should send for Catalogue.—Lumen Electric Co., Litherland, Liverpool, 21.

STAR Microphones complete with Circuit and transformer, 3/6; Western Electric Microphones (list, 21/-), 1/9; transformer to match, 1/3.

B.T.H. 2,500 ohms Speakers, 7/9; Mazda Power Valves, 3/-; Polar 2-way Short-wave Coil Holders, 9d., and 500 clearance lines. Catalogues 3d. each. All the above items, Post Free. J. Bearfield, 105, Upper Street, London, N.1.

RECEIVERS, COMPONENTS AND ACCESSORIES

Surplus, Clearance or Secondhand, etc.

SOUTHERN RADIO'S WIRELESS BARGAINS. ALL GOODS GUARANTEED NEW AND SENT POST PAID.

SPEAKERS.—Blue Spot 1035 Series, with Universal Transformers to match any circuit. 99 P.M., 24/6; 45 P.M., 20/-; 32 P.M., in exquisite cabinet, 42/6 (List, 87/6); 22 P.M., in attractive cabinet, 28/6; Mains Energised 2,500 and 6,500 Ohms, 14/6; Celestion Soudex Permanent Magnet, 11/-; Telsen Permanent Magnet Speakers, 16/-.

LISSEN KITS, ALL NEW IN SEALED CARTONS AND COMPLETE. With Specified Valves. Lissen Skyscraper 3-Valve Battery Kits, 42/- each (List, 77/6.) Lissen BAND PASS 3-Valve Battery Kits, 62/6 (List, 99/6). Lissen ALL-WAVE Four-Valve Battery Kits, 65/- (List, 112/6).

DEBMARK SHORT-WAVE ADAPTOR KIT. Complete with all accessories for adapting set for 14-150 Metres, 20/-. Superhet Short-Wave Converter Kit, 20/-.

MULLARD M.B.3 THREE-VALVE BATTERY SETS (Decontrolled). Complete with 3 Mullard Pentode Valves. Permanent Magnet Speaker Batteries and Accumulator. Contained in handsome walnut cabinet, 157/6 (List, 8 guineas). In original sealed cartons.

HOUSE TELEPHONES. A SPECIAL BARGAIN. BRAND NEW ONE-HAND TELEPHONES. Complete on stand, with or without Automatic Dials. Cost 14 each to manufacture, 10/- each.

ELIMINATORS.—Regentone 1935 Series. A.C. Mains, 200/250 volts, Type W5a, complete with trickle charger, 39/6; W1a (less trickle charger—carries 30 milliamperes), 33/-; W1c (less trickle charger), 30/-. All in sealed cartons.

CONDENSERS.—Lotus 0.0005. Fully screened, with trimmers, escutcheons, dials and knob. 3-gang, 11/-; 2-gang, 7/3. DYBLOCK SINGLE 0.0005, complete with all accessories, 4/-. TELSEN SINGLE VARIABLE CONDENSERS, 0.0005, 2/3; Plessey 4-gang Superhet, fully screened with trimmers, 7/3. Igranite, 1 mfd., 1/3, 2 mfd., 1/9.

COILS.—Igranite Superhet, Coil set of four (1 Osc., 2 I.F. with Pigtail, 1 I.F. plain), 9/- per set (List, 50/-). Varley Square Peak Coils, B.P.5, complete, 2/3. Telsen Iron-core Coils, W349 midget size, 4/6 each.

THE following Telsen Components in original sealed cartons at sacrifice prices:—A.C. H.F. TRANSFORMERS.—5/1, 2/9; Binocular H.F. Chokes, 2/-; Standard Screened H.F. Chokes, 2/-; ACE MICROPHONES (P.O.) with Transformers, 5/- each. This microphone can be used with any radio set and is a very efficient article.

AMERICAN VALVES.—A full range of valves for all American sets at 7/- per valve.

SOUTHERN RADIO BARGAIN PARCELS.—We are offering the following parcels of mixed components at a fraction of their value. The items comprise up-to-date Radio parts, new and perfect, which are too varied to be advertised individually:—

5/- PARCEL.—Contains modern components valued at 20/-, including Resistances, Condensers, Coils, Wire, etc. Circuits of modern Receivers included with each parcel.

20/- PARCEL.—This is known as the "small trader's" parcel, and contains a wonderful selection of components valued at 85/-. We have supplied this parcel to hundreds of Traders for re-sale at a profit.

SOUTHERN RADIO, 323 EUSTON ROAD, S. LONDON, N.W.1 (near Warren Street Tube). Phone: Museum 6321.

SOUTHERN RADIO Branches at 271-275, High Street, Willesden Green, N.W.10; 46, Lisle Street, W.C.2. All Mail Orders to 323, Euston Road, London, N.W.1.

WORURN RADIO CO., offer the following lines:—

SHORT WAVE CONDENSERS with slow and fast motion, .0001, .00015, .00016, .0002, .0003, .0005, 2/- each. Ormond two-piece dial for same, 1/-.

Short Wave Coils, 13-22, 20-44, and 40-90 metres, plug in type, 4 pin, 2/3; 6 pin, 2/6. S.W. Chokes, 10-100 m. 100 Pyc S.W. valve-holders, 6d.

ELECTRIC SOLDERING IRONS, 200/250 v., complete with flex and adaptor, copper bit, guaranteed 1/11. Post 6d. Heavier quality, 2/11, post 6d. (These resistances, all values to 4 meg., 6d. each.)

WESTINGHOUSE H.T.S and 8, 9/11. Dubilier. 5mfd. 500v. dry electrolytics, 2/9. Tubular condensers, .1, .01, .02, 6d.; .25 and 5, 9d.; .001 to .0005, tubular, 6d. J. B. Aeroplane dials with escutcheon, 3/11; square type, 4/6.

OLA P.M. SPEAKERS, 7in. cone, with power and pentode transformer, 16/6, postage 1/-. W.R.C. ELIMINATORS, A.C. Model, 21/-; A.C. with trickle charger, 32/6. Delivery ten days.

TRADE enquiries invited. Send trade heading and stamp for list.

WORURN RADIO CO., 9, Sandland Street, Holborn, W.C.1.

RADIO CLEARANCE. For list of bargains see previous issue.

SHORT WAVE ON A CRYSTAL SET. Full building instructions and crystal 1/2 post paid.—Radiomail, Tanworth-in-Arden, Warwickshire.

BIRMINGHAM RADIOMART W. NIGHTINGALE (G5NI)

ANNOUNCES

quality goods at lowest prices consistent with a square deal.

RADIOMART.—Bargain parcel value 30/-, containing binocular H.F.C. 4 750v. test condensers, 6 resistances, 4 valveholders, .0003, .0005 variable, electrolytic condenser, etc., 5/-. Traders' parcel, 24/10/0 value, 10/-.

RADIOMART.—Garrard new Gramotors, double spring, 12/6, single 7/6. Handies, 1/6. Soiled turntables, 1/6 extra.

RADIOMART.—Non-inductive condensers by leading makers, T.C.C., Dubilier, etc., 0.5, 0.25, 0.1, 0.02, 0.005, 3d.

RADIOMART.—Condensers by world's finest manufacturers, 1/2in. or 3/4in. shaft, 3-gang, 4-gang, 3-gang superhet, 1/11.

RADIOMART.—Astounding offer electrolytic condensers, world-famous maker, 4+4 mfd. (separate) 500v. working, 1/6.

RADIOMART.—Genuine 15/6 Frost potentiometers, wire-wound, tapered, 10,000 ganged to 50,000 ohms, 1/6.

RADIOMART.—Lissen 2-gang coils, 12-2,000 metres, switched and screened, nothing else required to convert S63 to all-wave, 12/6.

RADIOMART.—Lissen 3-gang bandpass superhet coils, 4/6; 3-gang bandpass Tuned grid, 6/11. All with circuits.

RADIOMART.—Amplion, 3/6; screened H.F. choke, 1/11. Iron-cored binocular, screened, 2/3. Climax binocular, 1/3. Telsen, 1/11.

RADIOMART.—Utility 2-gang .0005 Uniknob with large disc drive, 3/11. Ditto, single, with disc, 2/3.

RADIOMART.—Lissen 30hy., 40 ma., chokes, 2/-; 20 hy., 100 ma., 2/11. Lissen eliminator chokes, 1/3.

RADIOMART.—Igranite tapered potentiometers 1/2-meg., 1-meg. with 3-point switch, 2/-. Centralab, 1/2-meg., 1/6.

RADIOMART.—2 gross roundhead woodscrews assorted, 9d. Solder tags, 6d.; resincore solder, 9ft., 6d.

RADIOMART.—Pushback connecting wire, ready tinned and sleeved, 6yds., 6d. Heavy, for heaters, 9d.

RADIOMART.—Screened iron-cored selective dual-range coils, with reaction; circuit diagrams, 2/11.

RADIOMART.—Non-inductive tubulars, 1,500 v., 0.01, 0.02, 0.04, 0.05, 0.1, 6d.; 0.2, 0.25, 8d.; 0.5, 9d.

RADIOMART.—Lissen 6-way battery leads, with plugs, 6d. Belling-Lee safety mains plug and socket, 6d.

RADIOMART.—Insulated terminals, Belling-Lee, black, Telsen, red, black, 1d. Telsen 0.0003 presets, 9d.

RADIOMART.—Transformers: Igranite parafaced; manufacturers, push-pull, all 1/11. Electric Soldering Irons, 2/6.

RADIOMART.—Fuses, Telsen 1-amp., 1-amp., 3-amp., 2d. Telsen, 100 ma., 2d.

RADIOMART.—Telsen latest differentials, .0003, 1/3; .00015, 1/-. Radiogrand transformers, 3/6.

RADIOMART.—Special. Four assorted Telsen grid-leaks, 5d.; twelve various wire-ended resistances, 2/6.

RADIOMART.—Milliammeters; flush 2 1/2in., 5/9; 2 1/2in., 6/9. All ranges above 25 ma.

RADIOMART.—T.C.C. bias electrolytics, 50 mfd., 50 v., 1/5; 25 mfd., 25 v., 1/3; 15 mfd., 100 v., 1/-; 6 mfd., 50 v., 6d.

RADIOMART.—Caution: Beware of coilforms, etc., moulded in cheap bakelite. Our coils and formers are guaranteed efficient.

RADIOMART.—4-pin interchangeable short-wave coils; set 3. Cover 15-100 metres, latest ribbed former, 7/9.

RADIOMART.—1 1/2in. ribbed short-wave coil forms; valveholder type, 100s, 4-pin, 7/6. 6-pin, 1/9. Threaded for winding, 2d. extra.

RADIOMART.—Utley 8/6 microdisc dials, fitted famous micro high reduction, only perfect short-wave dial, 3/11.

RADIOMART.—Short-wave H.F. chokes, 9d. Wire-less World states: "Very efficient—100 to below 10 metres."

RADIOMART.—Utility microvariables 15, 40 mmfd., 1/-; 100 mmfd., 1/6; 465 kc/s litz wound I.F.'s, 5/6.

RADIOMART.—Radiophone super ceramic insulated short-wave condensers, .00016, 4/6; series gap, 5/-.

RADIOMART.—Continental A.C. valves, 4/6, VMPT, HPT, VMSG, ACSG, ACH, ACHL, P.T. Most American types, A.C.Pen., 5/6.

RADIOMART.—2 v. types, H.F. detector, L.F., 2/3; LP2, P2, 2/9; Snuper, 3/3; VMPT, HPT, 5/6; Class B, 4/6; S.G., VMSG, 5/-.

RADIOMART

Orders over 6/- post free. Enquirers must enclose stamp. Catalogues; general catalogue gives hundreds of bargains; short-wave illustrated catalogue also gives diagram of efficient transmitter and receiver; each 14d. Pair 3d., post free.

THE SQUARE DEALERS

19, John Bright St., 22, Summer Row; mail orders: 44, Holloway Road, Birmingham. Telephone: Midland 3254

RECEIVERS, COMPONENTS AND ACCESSORIES

Surplus, Clearance or Secondhand, etc.

REPAIRS to Moving Coil Speakers, Cones and Coils fitted or rewound. Fields altered. Prices Quoted Including Eliminators. Loud-speakers Repaired, 4/-. L.F. and Speech Transformers, 4/- Post Free. Trade invited. Guaranteed Satisfaction. Prompt Service, Estimates Free. L.S. Repair Service, 5, Balham Grove, London, S.W.12. Battersea 1321.

HEADPHONES.—Brown, Siemens, Ericsson, B.T.H., G.E.C., etc. 2,000 ohms, 2/6 pair; 4,000 ohms, 5/-; ditto, new, 5/- and 7/6. Special Brown, Type "A", 1,000, 2,000, 4,000 ohms, 15/-. Telefunken, 4,000 ohms, 7/6. Satisfaction guaranteed. Postage 6d.—Kodesh, 56, Barnsbury Street, London, N.1.

Vauxhall. All Goods Previously Advertised are Standard Lines. Still Available for Immediate Delivery. VAUXHALL UTILITIES, 163a, Strand, London, W.C.2. Temple Bar 9338; and at 50, Ludgate Hill, E.C.4.

RESISTANCES, 1 dozen good sizes, 1 watt metalised, 1/6; 2 mfd., 1,000v. Helsby, 3 for 2/-; screened H.F. chokes, 1/- Post Free.—FLEMING, 115, Ridley Road, E.8.

NEW RECEIVERS, COMPONENTS, AND ACCESSORIES

VALVES. By well-known manufacturers. Complete range of Battery, A.C. Mains, Rectifiers. Brand new stock with six months' guarantee. 2 volt. Detector, 2/3; Power, 2/9; Screen Grid, Pentode, H.F. Pentode, 5/-. Write for other prices to: Dulci Electrical Co., Ltd., 7, Lizard Street, London, E.C.1.

HULBERT for Quality Surplus Speakers.

HULBERT. All speakers previously advertised still available. All are brand new and made by one of the best-known British makers of high-grade moving-coil speakers. Prices from 10/6. All Music lovers interested in realistic reproduction should write for list of amazing bargains. Repeat orders are coming in daily. HULBERT, 6, Conduit Street, W.1.

MISCELLANEOUS

LORMOND SPARKS, Late Technical Staff Amateur Wireless and Wireless Magazine, is still THE CONSTRUCTOR'S CONSULTANT. Technical Queries 1/- each. Blueprint alterations, Theoretical Diagrams and Plan Drawings quoted by return. Stamped envelope requested with all letters. 9, Phœbe Road, Brockley, S.E.4. Phone, Lee Green 1271.

MOVIES at Home.—How to make your own Cinema Projector. Particulars free.—Movie-scope (L), Pear Tree Green, Dodinghurst, Essex.

MORE G. W. BARGAINS SPECIAL PURCHASE 1936 "Corinthian Super-tone" All Mains, S.G. and Pentode, 4 valve (inc. rect.) Receiver for A.C. Mains 100 to 250v. incorporating large Magnavox Moving-Coil Speaker, Illuminated Dial, Tone and Volume Control, Super Selective, Purity of Tone, having 3 watts output. Handsome Cabinet, new and in sealed cartons, carrying maker's guarantee. List Price, £9/9/-. Our price £4/17/6 carriage paid. Cash with order or C.O.D. Money refunded if not satisfied within 7 days. G. W. RADIO, 7, Chapel Street, Lamb's Conduit Street, London, W.C.1. Phone: Holborn 4434.

STATION NAME DIALS

A.C. £4 Sup'het 4 WESTINGHOUSE CENTAUR 3 J.B. LINACORE 2/- each S.T. 600 & S.T. 700 3/- each MONEY HICKS LTD 108-110 Hackford Road, London, S.W.9

FREE ADVICE BUREAU COUPON This coupon is available until January 4, 1936, and must be attached to all letters containing queries. PRACTICAL AND AMATEUR WIRELESS, 28/12/35.

**An Electrical Weekly
on Entirely New Lines**

THE
**ELECTRICAL
ENGINEER**

**6D. EVERY
FRIDAY**

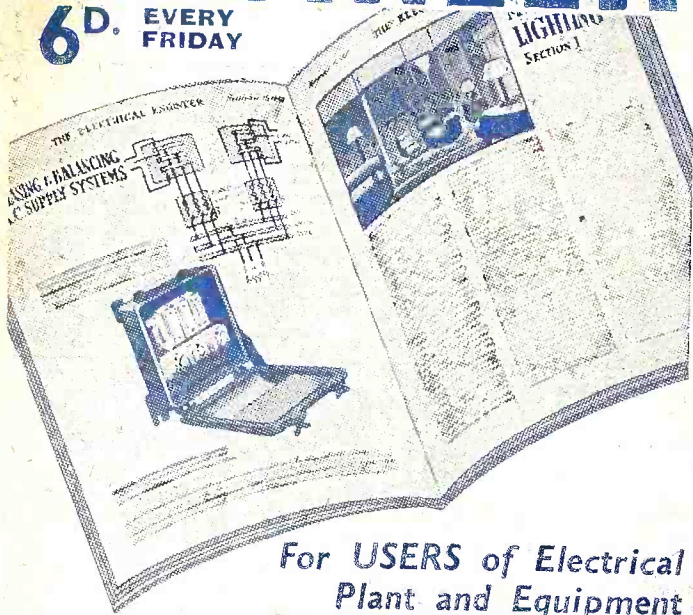

For **USERS** of Electrical
Plant and Equipment

WIRELESS, in which you are keenly interested, is a branch of Electrical Engineering, the most progressive industry in the country and one which, through the Grid Scheme, is due for very big expansion during the next few years.

There will be, of necessity, a growing demand for men who are well equipped to cope with electrical work of all kinds, from floodlighting a Town Hall to installing an Electrically Driven Pump on a farm.

You, with a good working knowledge of wireless practice, have covered the groundwork which may help you to a good position in the Electrical Industry.

To aid you comes "THE ELECTRICAL ENGINEER," the great new sixpenny weekly, with information that cannot be obtained in any existing books. Its articles are contributed by men who have had many years' experience on the practical side in various branches of Electrical work. To those who already have some knowledge of Electrical Theory this information will prove invaluable!

Become a subscriber to "THE ELECTRICAL ENGINEER" to-day and be ready for your opportunity when it presents itself!

A FREE COPY

A recent number will be sent to you by return if you send your name and address with 2d. to cover postage. Post to "The Electrical Engineer," George Newnes, Ltd., 8-11, Southampton Street, Strand, London, W.C.2

George Newnes, Ltd.

Special Contents of The
ELECTRICAL ENGINEER
now on sale include:

A Loudspeaking Automatic
Telephone

Motor Car Electrical
Equipment

Engineers' Experiences

Electric Welding in Industry

Safety in Domestic
Installations

Preparing Estimates for
Power Plant

Installing Induction Motors,
etc., etc.

**POPULAR
FLYING 6D.**

THE NATIONAL AVIATION
MAGAZINE FOR ALL WHO
ARE INTERESTED IN THIS
NEWEST MODE OF TRAVEL

**RECORD BREAKING DOWN
AFRICA**

By D. Llewelyn—who, last month, with Mrs. Wyndham, broke the Cape-London Record.

REUNION MEMORIES

By Mr. A. A. Nicod, 60 Squadron, R.F.C.

FLYING OVER ABYSSINIA

By a war correspondent on the Italian Front.

**RECOLLECTIONS AND
REFLECTIONS**

By A. J. Insall, Curator of Photographic Records, Imperial War Museum.

THE HUN IN THE CHIMNEY

A true war story.

**HOW TO BUILD A FLYING
SCALE MODEL
Sopwith "Camel."**

**STRIKING PICTURES OF THE
BYRD ANTARCTIC EXPEDITION
REVIEW OF AIR POST STAMPS
REMARKABLE TOPICAL AND
HISTORICAL PICTURES
LATEST AIR NEWS FROM ALL
COUNTRIES**

COMPLETE SHORT STORY, etc.

In the **JANUARY NUMBER**
JUST OUT

at all Newsagents and Bookstalls

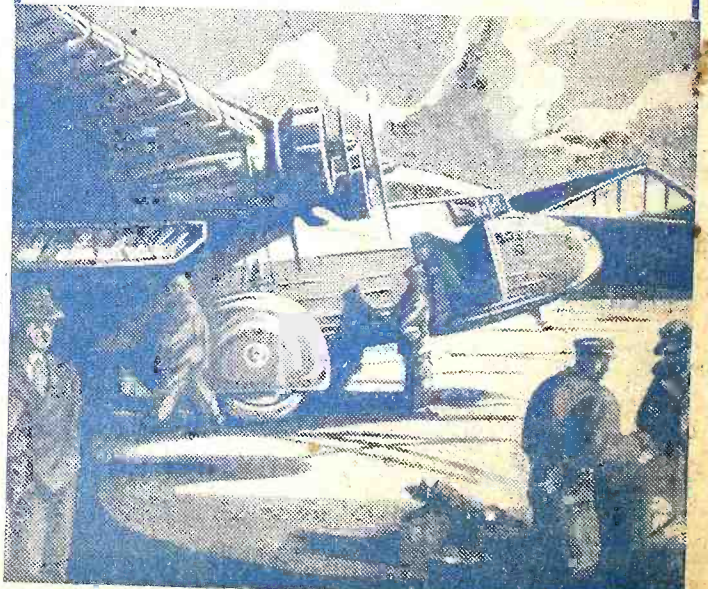

C. Arthur Pearson, Ltd.